

FEATURES

- Fast settling filter option
- 8 differential/16 pseudo differential input channels
- RMS noise: 11 nV at 4.7 Hz (gain = 128)
- 15.5 noise-free bits at 2.4 kHz (gain = 128)
- Up to 22 noise-free bits (gain = 1)
- Offset drift: ± 5 nV/ $^{\circ}$ C
- Gain drift: ± 1 ppm/ $^{\circ}$ C
- Programmable gain (1 to 128)
- Output data rate: 4.7 Hz to 4.8 kHz
- Internal or external clock
- Simultaneous 50 Hz/60 Hz rejection
- 4 general-purpose digital outputs
- Power supply
 - AV_{DD}: 3 V to 5.25 V
 - DV_{DD}: 2.7 V to 5.25 V
- Current: 4.65 mA
- Temperature range: -40° C to $+105^{\circ}$ C
- Package: 32-lead LFCSP
- Interface
 - 3-wire serial
 - SPI, QSPI™, MICROWIRE™, and DSP compatible
 - Schmitt trigger on SCLK

APPLICATIONS

- PLC/DCS analog input modules
- Data acquisition
- Strain gage transducers

- Pressure measurement
- Temperature measurement
- Flow measurement
- Weigh scales
- Chromatography
- Medical and scientific instrumentation

GENERAL DESCRIPTION

The AD7194 is a low noise, complete analog front end for high precision measurement applications. It contains a low noise, 24-bit sigma-delta (Σ - Δ) analog-to-digital converter (ADC). The on-chip low noise gain stage means that signals of small amplitude can interface directly to the ADC.

The device can be configured to have eight differential inputs or sixteen pseudo differential inputs. The on-chip 4.92 MHz clock can be used as the clock source to the ADC or, alternatively, an external clock or crystal can be used. The output data rate from the part can be varied from 4.7 Hz to 4.8 kHz.

The device has a very flexible digital filter, including a fast settling option. Variables such as output data rate and settling time are dependent on the option selected. For applications that require all conversions to be settled, the AD7194 includes zero latency.

The part operates with a power supply from 3 V to 5.25 V. It consumes a current of 4.65 mA, and it is housed in a 32-lead LFCSP package.

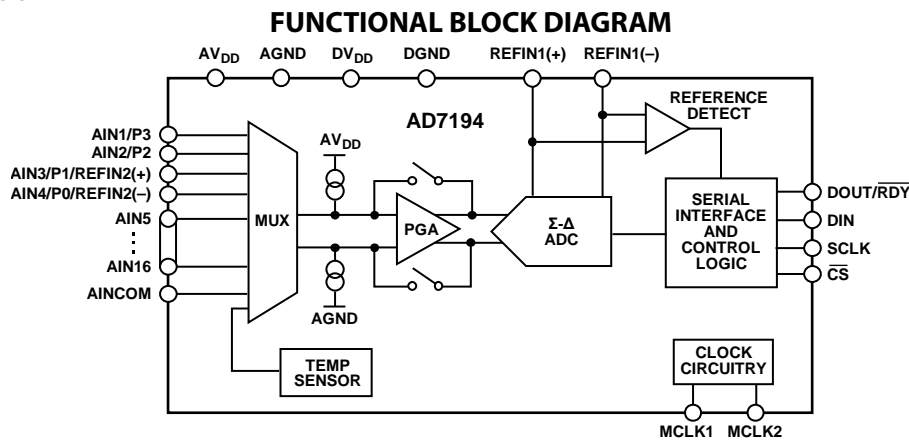

Figure 1.

TABLE OF CONTENTS

Features	1	Programmable Gain Array (PGA)	30
Applications	1	Reference	30
General Description	1	Reference Detect	31
Functional Block Diagram	1	Bipolar/Unipolar Configuration	31
Revision History	2	Data Output Coding	31
Specifications	3	Burnout Currents	31
Timing Characteristics	7	Digital Interface	32
Absolute Maximum Ratings	9	Reset	36
Thermal Resistance	9	System Synchronization	36
ESD Caution	9	Enable Parity	36
Pin Configuration and Function Descriptions	10	Clock	36
Typical Performance Characteristics	12	Temperature Sensor	36
RMS Noise and Resolution	15	Logic Outputs	37
Sinc ⁴ Chop Disabled	15	Calibration	37
Sinc ³ Chop Disabled	16	Digital Filter	39
Fast Settling	17	Sinc ⁴ Filter (Chop Disabled)	39
On-Chip Registers	18	Sinc ³ Filter (Chop Disabled)	41
Communications Register	19	Chop Enabled (Sinc ⁴ Filter)	43
Status Register	20	Chop Enabled (Sinc ³ Filter)	45
Mode Register	21	Fast Settling Mode (Sinc ⁴ Filter)	46
Configuration Register	24	Fast Settling Mode (Sinc ³ Filter)	48
Data Register	27	Fast Settling Mode (Chop Enabled)	50
ID Register	27	Summary of Filter Options	51
GPOCON Register	27	Grounding and Layout	52
Offset Register	28	Applications Information	53
Full-Scale Register	28	Flowmeter	53
ADC Circuit Information	29	Outline Dimensions	54
Overview	29	Ordering Guide	54
Analog Input Channel	30		

REVISION HISTORY

6/2017—Rev. A to Rev. B

Changed CP-32-11 to CP-32-12	Throughout
Changes to Table 5	11
Updated Outline Dimensions	54
Changes to Ordering Guide	54

3/2013—Rev. 0 to Rev. A

Changes to Pin 26, Table 5	11
Changes to Table 21	25
Changes to Analog Inputs Section	29
Changes to Data Output Coding Section	31

10/2009—Revision 0: Initial Version

SPECIFICATIONS

$AV_{DD} = 3\text{ V to }5.25\text{ V}$, $DV_{DD} = 2.7\text{ V to }5.25\text{ V}$, $AGND = DGND = 0\text{ V}$; $REFINx(+)$ = +2.5 V or AV_{DD} , $REFINx(-)$ = $AGND$, $MCLK = 4.92\text{ MHz}$, $T_A = T_{MIN}$ to T_{MAX} , unless otherwise noted.

Table 1.

Parameter	Min	Typ	Max	Unit	Test Conditions/Comments ¹
ADC					
Output Data Rate	4.7		4800	Hz	Chop disabled
	1.17		1200	Hz	Chop enabled, sinc ⁴ filter
	1.56		1600	Hz	Chop enabled, sinc ³ filter
No Missing Codes ²	24			Bits	$FS[9:0]^3 > 1$, sinc ⁴ filter
	24			Bits	$FS[9:0]^3 > 4$, sinc ³ filter
Resolution					See the RMS Noise and Resolution section
RMS Noise and Output Data Rates					See the RMS Noise and Resolution section
Integral Nonlinearity					
Gain = 1 ²		±2	±10	ppm of FSR	$AV_{DD} = 5\text{ V}$
Gain > 1		±2	±15	ppm of FSR	$AV_{DD} = 3\text{ V}$
		±5	±30	ppm of FSR	$AV_{DD} = 5\text{ V}$
		±15	±30	ppm of FSR	$AV_{DD} = 3\text{ V}$
Offset Error ^{4, 5}		±150/gain		μV	Chop disabled
		±1		μV	Chop enabled, $AV_{DD} = 5\text{ V}$
		±0.5		μV	Chop enabled, $AV_{DD} = 3\text{ V}$
Offset Error Drift vs. Temperature		±150/gain		nV/°C	Gain = 1 to 16; chop disabled
		±5		nV/°C	Gain = 32 to 128; chop disabled
		±5		nV/°C	Chop enabled
Gain Error ⁴		±0.001		%	$AV_{DD} = 5\text{ V}$, gain = 1, $T_A = 25^\circ\text{C}$ (factory calibration conditions)
		-0.4		%	Gain = 128, before full-scale calibration (see Table 27)
		±0.003		%	Gain > 1, after internal full-scale calibration, $AV_{DD} \geq 4.75\text{ V}$
		±0.005		%	Gain > 1, after internal full-scale calibration, $AV_{DD} < 4.75\text{ V}$
		±1		ppm/°C	
Power Supply Rejection	95	90		dB	Gain = 1, $V_{IN} = 1\text{ V}$
Common-Mode Rejection		110		dB	Gain > 1, $V_{IN} = 1\text{ V/gain}$
@ DC		110		dB	Gain = 1, $V_{IN} = 1\text{ V}$
@ DC	105	120		dB	Gain > 1, $V_{IN} = 1\text{ V/gain}$
@ 50 Hz, 60 Hz ²	120			dB	10 Hz output data rate, 50 Hz ± 1 Hz, 60 Hz ± 1 Hz
@ 50 Hz ²	120			dB	50 Hz output data rate, 50 Hz ± 1 Hz
@ 60 Hz ²	120			dB	60 Hz output data rate, 60 Hz ± 1 Hz
@ 50 Hz ²	115			dB	Fast settling, $FS[9:0]^3 = 6$, average by 16, 50 Hz ± 1 Hz
@ 60 Hz ²	115			dB	Fast settling, $FS[9:0]^3 = 5$, average by 16, 60 Hz ± 1 Hz

Parameter	Min	Typ	Max	Unit	Test Conditions/Comments ¹
Normal Mode Rejection ²					
Sinc ⁴ Filter					
Internal Clock					
@ 50 Hz, 60 Hz	100			dB	10 Hz output data rate, 50 Hz \pm 1 Hz, 60 Hz \pm 1 Hz
	74			dB	50 Hz output data rate, REJ60 ⁶ = 1, 50 Hz \pm 1 Hz, 60 Hz \pm 1 Hz
@ 50 Hz	96			dB	50 Hz output data rate, 50 Hz \pm 1 Hz
@ 60 Hz	97			dB	60 Hz output data rate, 60 Hz \pm 1 Hz
External Clock					
@ 50 Hz, 60 Hz	120			dB	10 Hz output data rate, 50 Hz \pm 1 Hz, 60 Hz \pm 1 Hz
	82			dB	50 Hz output data rate, REJ60 ⁶ = 1, 50 Hz \pm 1 Hz, 60 Hz \pm 1 Hz
@ 50 Hz	120			dB	50 Hz output data rate, 50 Hz \pm 1 Hz
@ 60 Hz	120			dB	60 Hz output data rate, 60 Hz \pm 1 Hz
Sinc ³ Filter					
Internal Clock					
@ 50 Hz, 60 Hz	75			dB	10 Hz output data rate, 50 Hz \pm 1 Hz, 60 Hz \pm 1 Hz
	60			dB	50 Hz output data rate, REJ60 ⁶ = 1, 50 Hz \pm 1 Hz, 60 Hz \pm 1 Hz
@ 50 Hz	70			dB	50 Hz output data rate, 50 Hz \pm 1 Hz
@ 60 Hz	70			dB	60 Hz output data rate, 60 Hz \pm 1 Hz
External Clock					
@ 50 Hz, 60 Hz	100			dB	10 Hz output data rate, 50 Hz \pm 1 Hz, 60 Hz \pm 1 Hz
	67			dB	50 Hz output data rate, REJ60 ⁶ = 1, 50 Hz \pm 1 Hz, 60 Hz \pm 1 Hz
@ 50 Hz	95			dB	50 Hz output data rate, 50 Hz \pm 1 Hz
@ 60 Hz	95			dB	60 Hz output data rate, 60 Hz \pm 1 Hz
Fast Settling					
Internal Clock					
@ 50 Hz	26			dB	FS[9:0] ³ = 6, average by 16, 50 Hz \pm 0.5 Hz
@ 60 Hz	26			dB	FS[9:0] ³ = 5, average by 16, 60 Hz \pm 0.5 Hz
External Clock					
@ 50 Hz	40			dB	FS[9:0] ³ = 6, average by 16, 50 Hz \pm 0.5 Hz
@ 60 Hz	40			dB	FS[9:0] ³ = 5, average by 16, 60 Hz \pm 0.5 Hz
ANALOG INPUTS					
Differential Input Voltage Ranges		$\pm V_{REF}/\text{gain}$		V	$V_{REF} = \text{REFIN}_x(+)-\text{REFIN}_x(-)$, gain = 1 to 128
	$-(AV_{DD}-1.25\text{ V})/\text{gain}$		$+(AV_{DD}-1.25\text{ V})/\text{gain}$	V	Gain > 1
Absolute AIN Voltage Limits ²					
Unbuffered Mode	AGND - 0.05		$AV_{DD} + 0.05$	V	
Buffered Mode	AGND + 0.25		$AV_{DD} - 0.25$	V	
Analog Input Current					
Buffered Mode					
Input Current ²	-2		+2	nA	Gain = 1
	-3		+3	nA	Gain > 1
Input Current Drift		± 5		pA/ $^{\circ}\text{C}$	
Unbuffered Mode					
Input Current		± 3.5		$\mu\text{A}/\text{V}$	Gain = 1, input current varies with input voltage
		± 1		$\mu\text{A}/\text{V}$	Gain > 1
Input Current Drift		± 0.05		nA/ $^{\circ}\text{C}$	External clock
		± 1.6		nA/ $^{\circ}\text{C}$	Internal clock

Parameter	Min	Typ	Max	Unit	Test Conditions/Comments ¹
REFERENCE INPUT					
REFIN Voltage	1		AV_{DD}	V	REFIN = REFINx(+) – REFINx(-), the differential input must be limited to $\pm(AV_{DD} - 1.25\text{ V})/\text{gain}$ when gain > 1
Absolute REFIN Voltage Limits ²	$AGND - 0.05$		$AV_{DD} + 0.05$	V	
Average Reference Input Current		4.5		$\mu\text{A/V}$	
Average Reference Input Current Drift		± 0.03		$\text{nA/V}/^\circ\text{C}$	External clock
		± 1.3		$\text{nA/V}/^\circ\text{C}$	Internal clock
Normal Mode Rejection ²		Same as for analog inputs			
Common-Mode Rejection		100		dB	
Reference Detect Levels	0.3		0.6	V	
TEMPERATURE SENSOR					
Accuracy		± 2		$^\circ\text{C}$	Applies after user calibration at 25 $^\circ\text{C}$
Sensitivity		2815		Codes/ $^\circ\text{C}$	Bipolar mode
BURNOUT CURRENTS					
AIN Current		500		nA	Analog inputs must be buffered and chop disabled
DIGITAL OUTPUTS (P0 to P3)					
Output High Voltage, V_{OH}	$AV_{DD} - 0.6$			V	$AV_{DD} = 3\text{ V}$, $I_{SOURCE} = 100\ \mu\text{A}$
	4			V	$AV_{DD} = 5\text{ V}$, $I_{SOURCE} = 200\ \mu\text{A}$
Output Low Voltage, V_{OL}			0.4	V	$AV_{DD} = 3\text{ V}$, $I_{SINK} = 100\ \mu\text{A}$
			0.4	V	$AV_{DD} = 5\text{ V}$, $I_{SINK} = 800\ \mu\text{A}$
Floating-State Leakage Current ²	-100		+100	nA	
Floating-State Output Capacitance		10		pF	
INTERNAL/EXTERNAL CLOCK					
Internal Clock					
Frequency	4.72		5.12	MHz	
Duty Cycle		50:50		%	
External Clock/Crystal					
Frequency	2.4576	4.9152	5.12	MHz	
Input Low Voltage, V_{INL}			0.8	V	$DV_{DD} = 5\text{ V}$
			0.4	V	$DV_{DD} = 3\text{ V}$
Input High Voltage, V_{INH}	2.5			V	$DV_{DD} = 3\text{ V}$
	3.5			V	$DV_{DD} = 5\text{ V}$
Input Current	-10		+10	μA	
LOGIC INPUTS					
Input High Voltage, V_{INH}^2	2			V	
Input Low Voltage, V_{INL}^2			0.8	V	
Hysteresis ²	0.1		0.25	V	
Input Currents	-10		+10	μA	
LOGIC OUTPUT (DOUT/RDY)					
Output High Voltage, V_{OH}^2	$DV_{DD} - 0.6$			V	$DV_{DD} = 3\text{ V}$, $I_{SOURCE} = 100\ \mu\text{A}$
	4			V	$DV_{DD} = 5\text{ V}$, $I_{SOURCE} = 200\ \mu\text{A}$
Output Low Voltage, V_{OL}^2			0.4	V	$DV_{DD} = 3\text{ V}$, $I_{SINK} = 100\ \mu\text{A}$
			0.4	V	$DV_{DD} = 5\text{ V}$, $I_{SINK} = 1.6\text{ mA}$
Floating-State Leakage Current	-10		+10	μA	
Floating-State Output Capacitance		10		pF	
Data Output Coding		Offset binary			

Parameter	Min	Typ	Max	Unit	Test Conditions/Comments ¹
SYSTEM CALIBRATION ²					
Full-Scale Calibration Limit			1.05 × FS	V	
Zero-Scale Calibration Limit	-1.05 × FS			V	
Input Span	0.8 × FS		2.1 × FS	V	
POWER REQUIREMENTS ⁷					
Power Supply Voltage					
AV _{DD} – AGND	3		5.25	V	
DV _{DD} – DGND	2.7		5.25	V	
Power Supply Currents					
AI _{DD} Current		0.85	1.1	mA	Gain = 1, buffer off
		1	1.35	mA	Gain = 1, buffer on
		2.8	3.6	mA	Gain = 8, buffer off
		3.2	3.85	mA	Gain = 8, buffer on
		3.8	4.7	mA	Gain = 16 to 128, buffer off
		4.3	5.3	mA	Gain = 16 to 128, buffer on
DI _{DD} Current		0.35	0.4	mA	DV _{DD} = 3 V
		0.5	0.6	mA	DV _{DD} = 5 V
		1.5		mA	External crystal used
I _{DD}			3	μA	Power-down mode

¹ Temperature range: -40°C to +105°C.

² Specification is not production tested, but is supported by characterization data at initial product release.

³ FS[9:0] is the decimal equivalent of Bit FS9 to Bit FS0 in the mode register.

⁴ Following a system or internal zero-scale calibration, the offset error is in the order of the noise for the programmed gain and output data rate selected. A system full-scale calibration reduces the gain error to the order of the noise for the programmed gain and output data rate.

⁵ The analog inputs are configured for differential mode.

⁶ REJ60 is a bit in the mode register. When the first notch of the sinc filter is at 50 Hz, a notch is placed at 60 Hz when REJ60 is set to 1. This gives simultaneous 50 Hz/60 Hz rejection.

⁷ Digital inputs equal to DV_{DD} or DGND.

TIMING CHARACTERISTICS

$AV_{DD} = 3\text{ V to }5.25\text{ V}$, $DV_{DD} = 2.7\text{ V to }5.25\text{ V}$, $AGND = DGND = 0\text{ V}$, Input Logic 0 = 0 V, Input Logic 1 = DV_{DD} , unless otherwise noted.

Table 2.

Parameter	Limit at T_{MIN} , T_{MAX} (B Version)	Unit	Conditions/Comments ^{1, 2}
READ AND WRITE OPERATIONS			
t_3	100	ns min	SCLK high pulse width
t_4	100	ns min	SCLK low pulse width
READ OPERATION			
t_1	0	ns min	\overline{CS} falling edge to DOUT/ \overline{RDY} active time
	60	ns max	$DV_{DD} = 4.75\text{ V to }5.25\text{ V}$
	80	ns max	$DV_{DD} = 2.7\text{ V to }3.6\text{ V}$
t_2^3	0	ns min	SCLK active edge to data valid delay ⁴
	60	ns max	$DV_{DD} = 4.75\text{ V to }5.25\text{ V}$
	80	ns max	$DV_{DD} = 2.7\text{ V to }3.6\text{ V}$
$t_5^{5, 6}$	10	ns min	Bus relinquish time after \overline{CS} inactive edge
	80	ns max	
t_6	0	ns min	SCLK inactive edge to \overline{CS} inactive edge
t_7	10	ns min	SCLK inactive edge to DOUT/ \overline{RDY} high
WRITE OPERATION			
t_8	0	ns min	\overline{CS} falling edge to SCLK active edge setup time ⁴
t_9	30	ns min	Data valid to SCLK edge setup time
t_{10}	25	ns min	Data valid to SCLK edge hold time
t_{11}	0	ns min	\overline{CS} rising edge to SCLK edge hold time

¹ Sample tested during initial release to ensure compliance. All input signals are specified with $t_R = t_F = 5\text{ ns}$ (10% to 90% of DV_{DD}) and timed from a voltage level of 1.6 V.

² See Figure 3 and Figure 4.

³ These numbers are measured with the load circuit shown in Figure 2 and defined as the time required for the output to cross the V_{OL} or V_{OH} limits.

⁴ The SCLK active edge is the falling edge of SCLK.

⁵ These numbers are derived from the measured time taken by the data output to change 0.5 V when loaded with the circuit shown in Figure 2. The measured number is then extrapolated back to remove the effects of charging or discharging the 50 pF capacitor. This means that the times quoted in the timing characteristics are the true bus relinquish times of the part and, as such, are independent of external bus loading capacitances.

⁶ \overline{RDY} returns high after a read of the data register. In single conversion mode and continuous conversion mode, the same data can be read again, if required, while \overline{RDY} is high, although care should be taken to ensure that subsequent reads do not occur close to the next output update. If the continuous read feature is enabled, the digital word can be read only once.

Circuit and Timing Diagrams

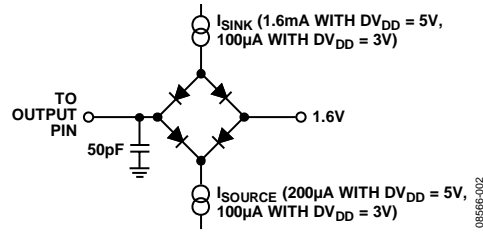

Figure 2. Load Circuit for Timing Characterization

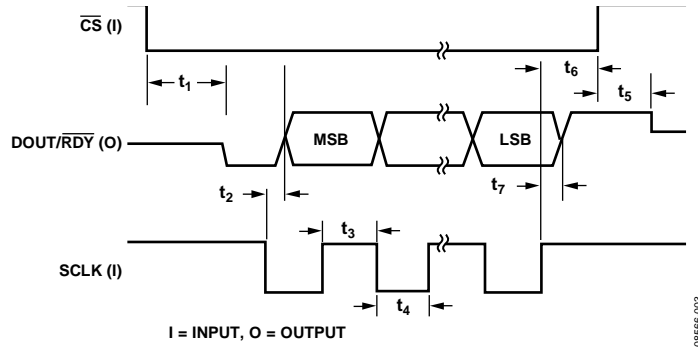

Figure 3. Read Cycle Timing Diagram

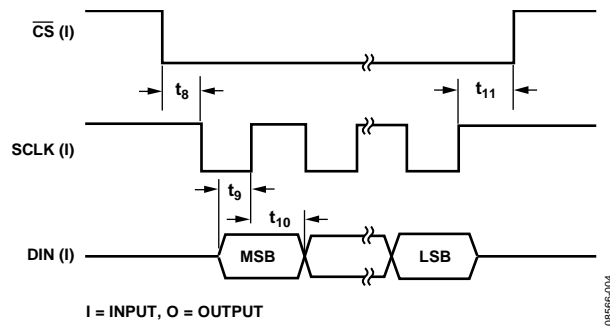

Figure 4. Write Cycle Timing Diagram

ABSOLUTE MAXIMUM RATINGS

$T_A = 25^\circ\text{C}$, unless otherwise noted.

Table 3.

Parameter	Rating
AV_{DD} to AGND	-0.3 V to +6.5 V
DV_{DD} to AGND	-0.3 V to +6.5 V
AGND to DGND	-0.3 V to +0.3 V
Analog Input Voltage to AGND	-0.3 V to $AV_{DD} + 0.3$ V
Reference Input Voltage to AGND	-0.3 V to $AV_{DD} + 0.3$ V
Digital Input Voltage to DGND	-0.3 V to $DV_{DD} + 0.3$ V
Digital Output Voltage to DGND	-0.3 V to $DV_{DD} + 0.3$ V
AINx/Digital Input Current	10 mA
Operating Temperature Range	-40°C to $+105^\circ\text{C}$
Storage Temperature Range	-65°C to $+150^\circ\text{C}$
Maximum Junction Temperature	150°C
Lead Temperature, Soldering Reflow	260°C

Stresses at or above those listed under Absolute Maximum Ratings may cause permanent damage to the product. This is a stress rating only; functional operation of the product at these or any other conditions above those indicated in the operational section of this specification is not implied. Operation beyond the maximum operating conditions for extended periods may affect product reliability.

THERMAL RESISTANCE

θ_{JA} is specified for the worst-case conditions, that is, a device soldered in a circuit board for surface-mount packages.

Table 4. Thermal Resistance

Package Type	θ_{JA}	θ_{JC}	Unit
32-Lead LFCSP	32.5	32.71	$^\circ\text{C}/\text{W}$

ESD CAUTION



ESD (electrostatic discharge) sensitive device. Charged devices and circuit boards can discharge without detection. Although this product features patented or proprietary protection circuitry, damage may occur on devices subjected to high energy ESD. Therefore, proper ESD precautions should be taken to avoid performance degradation or loss of functionality.

PIN CONFIGURATION AND FUNCTION DESCRIPTIONS

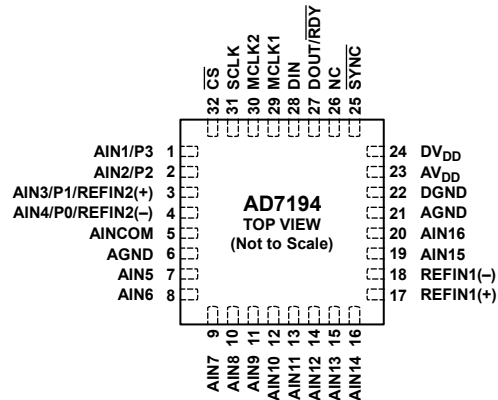

NOTES

1. NC = NO CONNECT.
2. CONNECT EXPOSED PAD TO AGND.

08956-005

Figure 5. Pin Configuration

Table 5. Pin Function Descriptions

Pin No.	Mnemonic	Description
1	AIN1/P3	Analog Input/Digital Output Pin. This pin can function as an analog input pin. When the GP32EN bit is set to 1, the pin functions as a general-purpose output bit referenced between AV_{DD} and AGND.
2	AIN2/P2	Analog Input/Digital Output Pin. This pin can function as an analog input pin. When the GP32EN bit is set to 1, the pin functions as a general-purpose output bit referenced between AV_{DD} and AGND.
3	AIN3/P1/REFIN2(+)	Analog Input/Digital Output Pin/Positive Reference Input. This pin functions as an analog input pin. When the GP10EN bit is set to 1, the pin functions as a general-purpose output bit referenced between AV_{DD} and AGND. When the REFSEL bit in the configuration register is set to 1, this pin functions as REFIN2(+). An external reference can be applied between REFIN2(+) and REFIN2(-). REFIN2(+) can lie anywhere between AV_{DD} and $AGND + 1 V$.
4	AIN4/P0/REFIN2(-)	Analog Input/Digital Output Pin/Positive Reference Input. This pin functions as an analog input pin. When the GP10EN bit is set to 1, the pin functions as a general-purpose output bit referenced between AV_{DD} and AGND. When the REFSEL bit in the configuration register is set to 1, this pin functions as REFIN2(-). An external reference can be applied between REFIN2(+) and REFIN2(-). This reference input can lie anywhere between AGND and $AV_{DD} - 1 V$.
5	AINCOM	Analog Input AIN1 to Analog Input AIN16 are referenced to this input when the bit pseudo is set to 1.
6	AGND	Analog Ground Reference Point.
7	AIN5	Analog Input Pin.
8	AIN6	Analog Input Pin.
9	AIN7	Analog Input Pin.
10	AIN8	Analog Input Pin.
11	AIN9	Analog Input Pin.
12	AIN10	Analog Input Pin.
13	AIN11	Analog Input Pin.
14	AIN12	Analog Input Pin.
15	AIN13	Analog Input Pin.
16	AIN14	Analog Input Pin.
17	REFIN1(+)	Positive Reference Input. An external reference can be applied between REFIN1(+) and REFIN1(-). REFIN1(+) can lie anywhere between AV_{DD} and $AGND + 1 V$. The nominal reference voltage, (REFIN1(+)-REFIN1(-)), is AV_{DD} , but the part functions with a reference from 1 V to AV_{DD} .
18	REFIN1(-)	Negative Reference Input. This reference input can lie anywhere between AGND and $AV_{DD} - 1 V$.
19	AIN15	Analog Input Pin.
20	AIN16	Analog Input Pin.
21	AGND	Analog Ground Reference Point.
22	DGND	Digital Ground Reference Point.

Pin No.	Mnemonic	Description
23	AV _{DD}	Analog Supply Voltage, 3 V to 5.25 V. AV _{DD} is independent of DV _{DD} . Therefore, DV _{DD} can be operated at 3 V with AV _{DD} at 5 V or vice versa.
24	DV _{DD}	Digital Supply Voltage, 2.7 V to 5.25 V. DV _{DD} is independent of AV _{DD} . Therefore, AV _{DD} can be operated at 3 V with DV _{DD} at 5 V or vice versa.
25	$\overline{\text{SYNC}}$	Logic input that allows for synchronization of the digital filters and analog modulators when using a number of AD7194 devices. While $\overline{\text{SYNC}}$ is low, the nodes of the digital filter, the filter control logic, and the calibration control logic are reset, and the analog modulator is also held in its reset state. $\overline{\text{SYNC}}$ does not affect the digital interface but does reset $\overline{\text{RDY}}$ to a high state if it is low. $\overline{\text{SYNC}}$ has a pull-up resistor internally to DV _{DD} .
26	NC	No Connect. Do not connect to this pin.
27	DOUT/ $\overline{\text{RDY}}$	Serial Data Output/Data Ready Output. DOUT/ $\overline{\text{RDY}}$ serves a dual purpose. It functions as a serial data output pin to access the output shift register of the ADC. The output shift register can contain data from any of the on-chip data or control registers. In addition, DOUT/ $\overline{\text{RDY}}$ operates as a data ready pin, going low to indicate the completion of a conversion. If the data is not read after the conversion, the pin goes high before the next update occurs. The DOUT/ $\overline{\text{RDY}}$ falling edge can be used as an interrupt to a processor, indicating that valid data is available. With an external serial clock, the data can be read using the DOUT/ $\overline{\text{RDY}}$ pin. With $\overline{\text{CS}}$ low, the data-/control-word information is placed on the DOUT/ $\overline{\text{RDY}}$ pin on the SCLK falling edge and is valid on the SCLK rising edge.
28	DIN	Serial Data Input to the Input Shift Register on the ADC. Data in this shift register is transferred to the control registers in the ADC, with the register selection bits of the communications register identifying the appropriate register.
29	MCLK1	When the master clock for the device is provided externally by a crystal, the crystal is connected between MCLK1 and MCLK2.
30	MCLK2	Master Clock Signal for the Device. The AD7194 has an internal 4.92 MHz clock. This internal clock can be made available on the MCLK2 pin. The clock for the AD7194 can also be provided externally in the form of a crystal or external clock. A crystal can be tied across the MCLK1 and MCLK2 pins. Alternatively, the MCLK2 pin can be driven with a CMOS-compatible clock and with the MCLK1 pin remaining unconnected.
31	SCLK	Serial Clock Input. This serial clock input is for data transfers to and from the ADC. The SCLK has a Schmitt-triggered input, making the interface suitable for opto-isolated applications. The serial clock can be continuous with all data transmitted in a continuous train of pulses. Alternatively, it can be a noncontinuous clock with the information transmitted to or from the ADC in smaller batches of data.
32	$\overline{\text{CS}}$	Chip Select Input. This is an active low logic input used to select the ADC. $\overline{\text{CS}}$ can be used to select the ADC in systems with more than one device on the serial bus or as a frame synchronization signal in communicating with the device. $\overline{\text{CS}}$ can be hardwired low, allowing the ADC to operate in 3-wire mode with SCLK, DIN, and DOUT used to interface with the device.
	EPAD	Exposed Pad. Connect the exposed pad to AGND.

TYPICAL PERFORMANCE CHARACTERISTICS

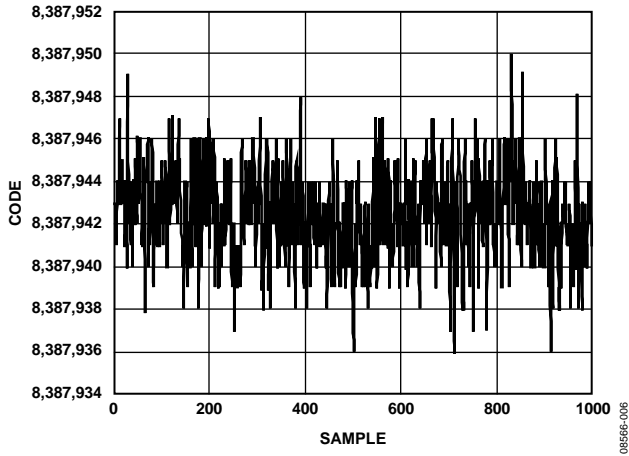

Figure 6. Noise ($V_{REF} = AV_{DD} = 5\text{ V}$, Output Data Rate = 4.7 Hz, Gain = 128, Chop Disabled, Sinc⁴ Filter)

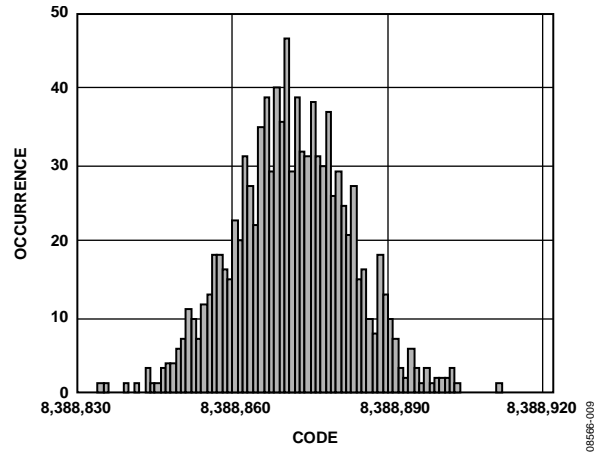

Figure 9. Noise Distribution Histogram ($V_{REF} = AV_{DD} = 5\text{ V}$, Output Data Rate = 2400 Hz, Gain = 1, Chop Disabled, Sinc⁴ Filter)

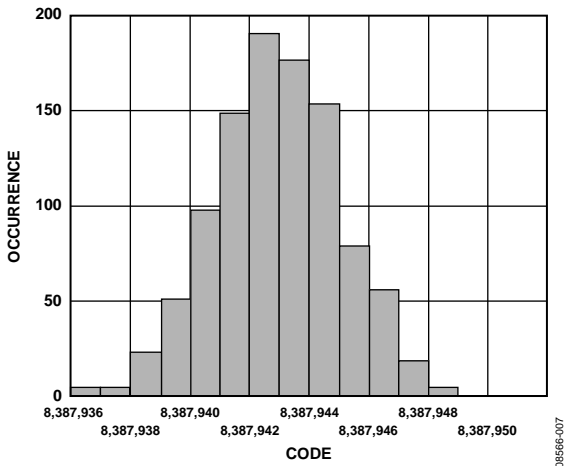

Figure 7. Noise Distribution Histogram ($V_{REF} = AV_{DD} = 5\text{ V}$, Output Data Rate = 4.7 Hz, Gain = 128, Chop Disabled, Sinc⁴ Filter)

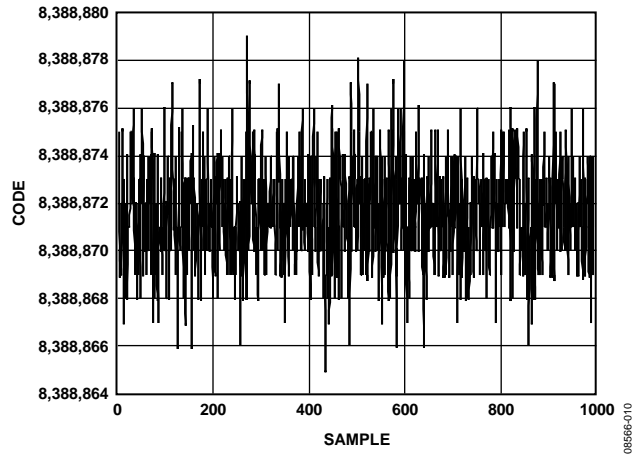

Figure 10. Noise ($V_{REF} = AV_{DD} = 5\text{ V}$, Output Data Rate = 42.1 Hz (FS[9:0] = 6, Average by 16), Gain = 1, Chop Disabled, Sinc⁴ Filter)

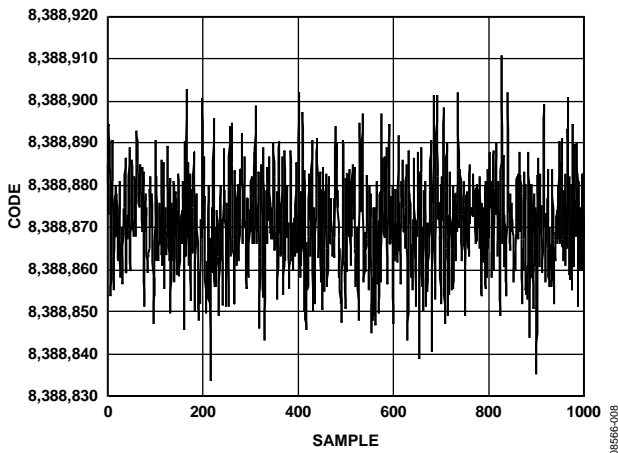

Figure 8. Noise ($V_{REF} = AV_{DD} = 5\text{ V}$, Output Data Rate = 2400 Hz, Gain = 1, Chop Disabled, Sinc⁴ Filter)

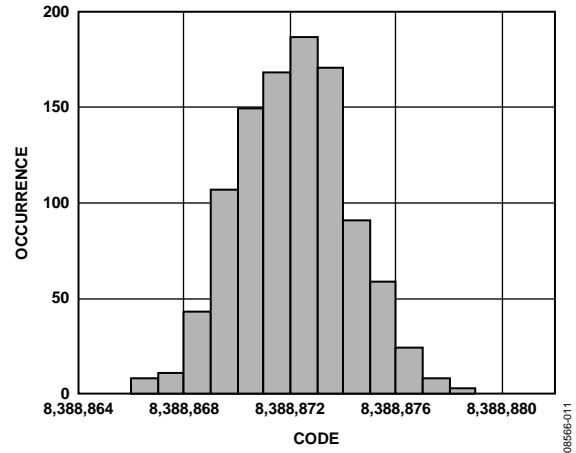

Figure 11. Noise Distribution Histogram ($V_{REF} = AV_{DD} = 5\text{ V}$, Output Data Rate = 42.1 Hz (FS[9:0] = 6, Average by 16), Gain = 1, Chop Disabled, Sinc⁴ Filter)

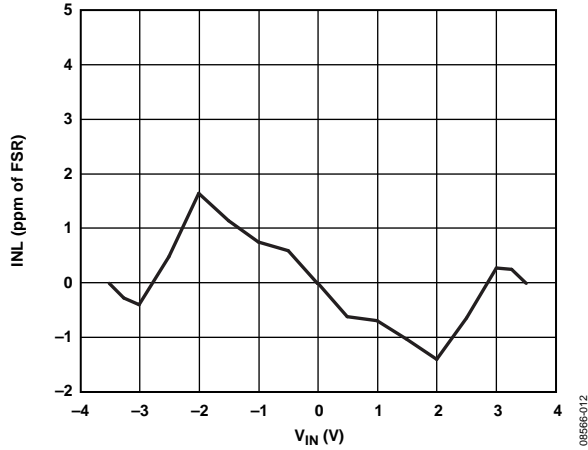

Figure 12. INL (Gain = 1)

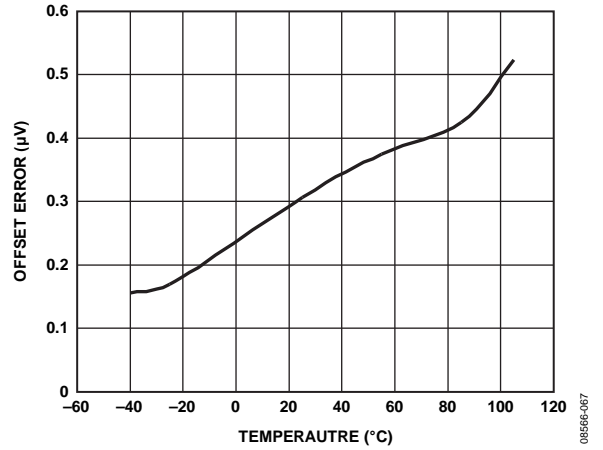

Figure 15. Offset vs. Temperature (Gain = 128, Chop Disabled)

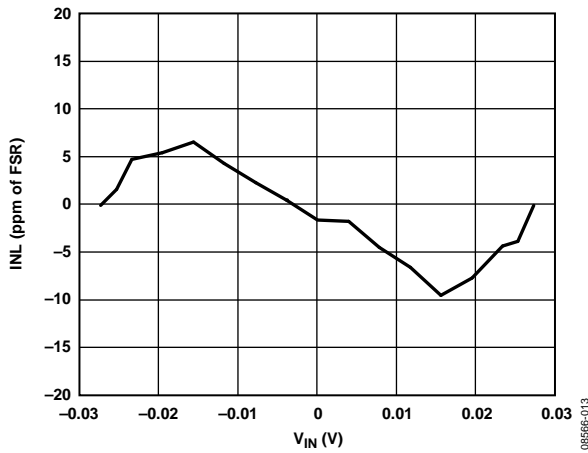

Figure 13. INL (Gain = 128)

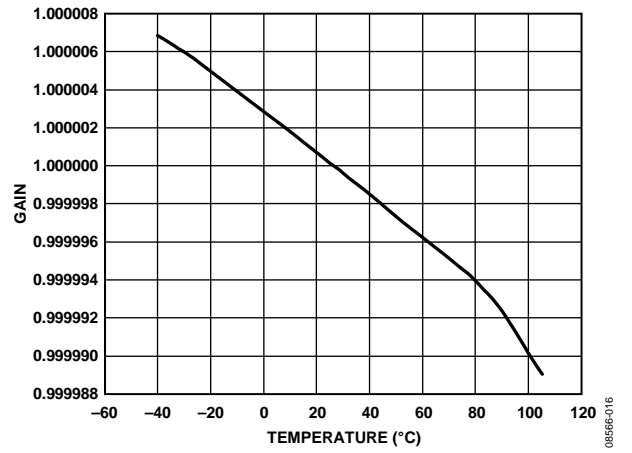

Figure 16. Gain vs. Temperature (Gain = 1)

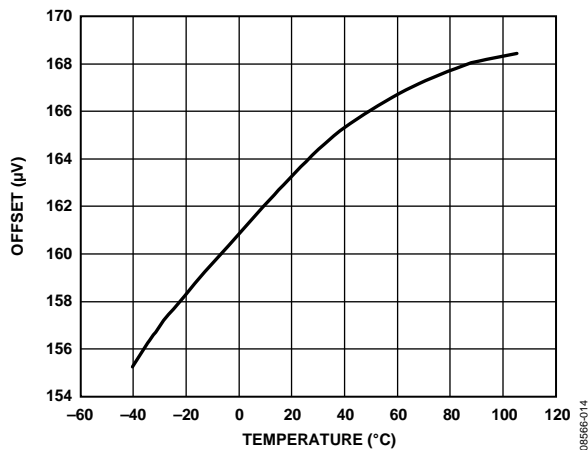

Figure 14. Offset vs. Temperature (Gain = 1, Chop Disabled)

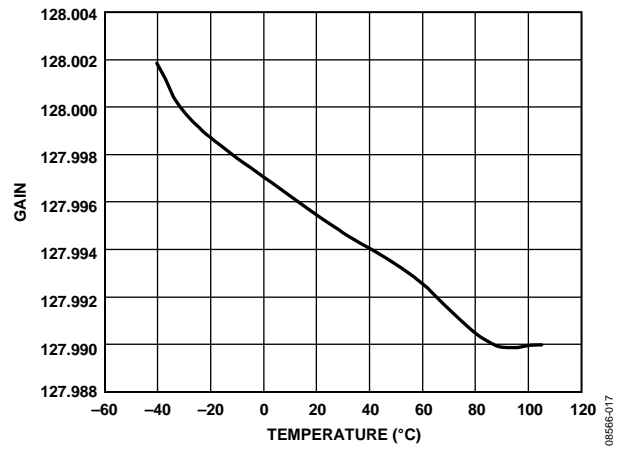

Figure 17. Gain vs. Temperature (Gain = 128)

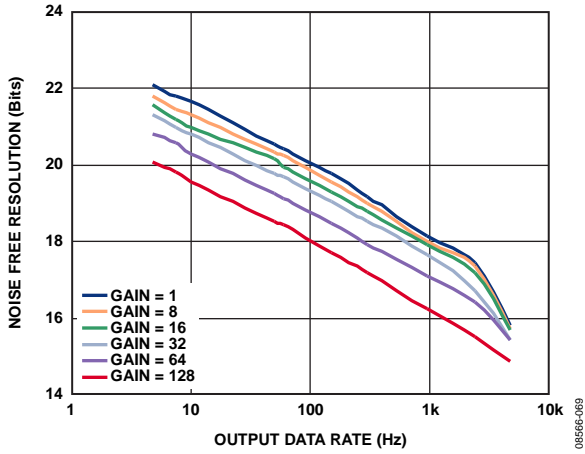

Figure 18. Noise-Free Resolution ($Sinc^4$ Filter, Chop Disabled, $V_{REF} = 5 V$)

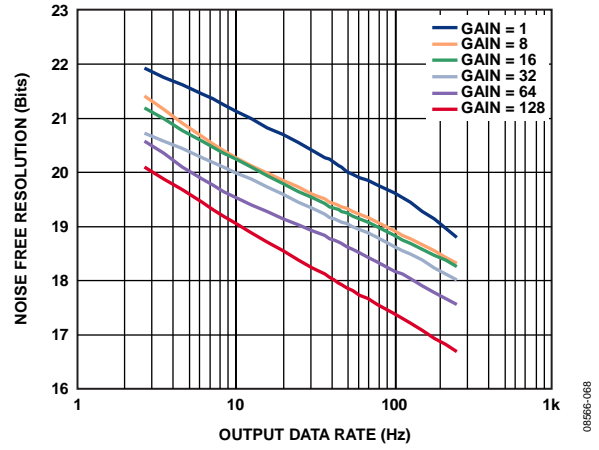

Figure 20. Noise-Free Resolution in Fast Settling Mode ($V_{REF} = 5 V$, Averaging by 16, $Sinc^4$ Filter, Chop Disabled)

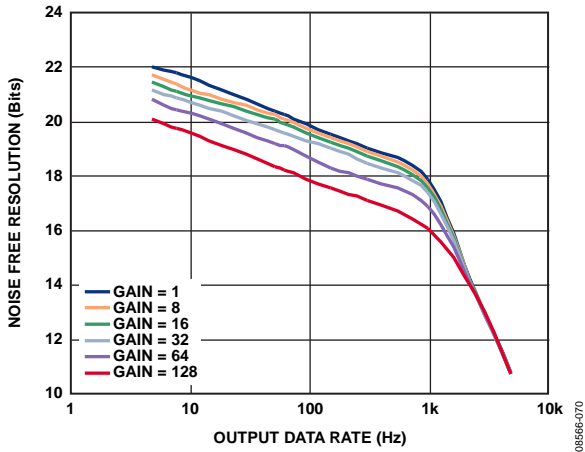

Figure 19. Noise-Free Resolution ($Sinc^3$ Filter, Chop Disabled, $V_{REF} = 5 V$)

RMS NOISE AND RESOLUTION

The following tables show the rms noise, peak-to-peak noise, effective resolution, and noise-free (peak-to-peak) resolution of the AD7194 for various output data rates and gain settings with chop disabled for the sinc⁴ and sinc³ filters and for fast settling mode. The numbers given are for the bipolar input range with an external 5 V reference. These numbers are typical and are generated with a differential input voltage of 0 V when the ADC

is continuously converting on a single channel. It is important to note that the effective resolution is calculated using the rms noise, whereas the peak-to-peak resolution is calculated based on peak-to-peak noise. The peak-to-peak resolution represents the resolution for which there is no code flicker. With chop enabled, the resolution improves by 0.5 bits.

SINC⁴ CHOP DISABLED

Table 6. RMS Noise (nV) vs. Gain and Output Data Rate

Filter Word (Decimal)	Output Data Rate (Hz)	Settling Time (ms)	Gain of					
			1	8	16	32	64	128
1023	4.7	852.5	370	57	35	18	13	11
640	7.5	533	440	73	41	24	17	13
480	10	400	470	83	45	28	18	16
96	50	80	1100	150	85	52	38	34
80	60	66.7	1200	170	94	56	42	38
32	150	26.7	1800	260	150	86	65	59
16	300	13.3	2500	360	210	130	95	83
5	960	4.17	4500	640	370	230	170	150
2	2400	1.67	7500	1100	600	380	280	240
1	4800	0.83	26,000	3400	1800	940	550	390

Table 7. Peak-to-Peak Noise (nV) vs. Gain and Output Data Rate

Filter Word (Decimal)	Output Data Rate (Hz)	Settling Time (ms)	Gain of					
			1	8	16	32	64	128
1023	4.7	852.5	2200	340	200	120	84	70
640	7.5	533	2700	430	260	150	100	85
480	10	400	3000	480	300	170	120	100
96	50	80	6600	950	540	350	250	210
80	60	66.7	7200	1000	610	370	270	220
32	150	26.7	11,000	1600	970	580	430	370
16	300	13.3	17,000	2400	1400	840	620	530
5	960	4.17	35,000	4800	2500	1500	1100	1000
2	2400	1.67	56,000	7500	4200	2900	1800	1700
1	4800	0.83	175,000	23,000	12,000	7100	3600	2600

Table 8. Effective Resolution (Peak-to-Peak Resolution) vs. Gain and Output Data Rate

Filter Word (Decimal)	Output Data Rate (Hz)	Settling Time (ms)	Gain of ¹					
			1	8	16	32	64	128
1023	4.7	852.5	24 (22.1)	24 (21.8)	24 (21.6)	24 (21.3)	23.5 (20.8)	22.8 (20.1)
640	7.5	533	24 (21.8)	24 (21.5)	23.9 (21.2)	23.6 (21)	23.1 (20.6)	22.5 (19.8)
480	10	400	24 (21.7)	24 (21.3)	23.7 (21)	23.4 (20.8)	23 (20.3)	22.2 (19.6)
96	50	80	23.1 (20.5)	23 (20.3)	22.8 (20.1)	22.5 (19.8)	22 (19.3)	21.1 (18.5)
80	60	66.7	23 (20.4)	22.9 (20.3)	22.7 (20)	22.4 (19.7)	21.8 (19.1)	21 (18.4)
32	150	26.7	22.4 (19.8)	22.3 (19.6)	22 (19.3)	21.8 (19)	21.2 (18.5)	20.3 (17.7)
16	300	13.3	21.9 (19.2)	21.8 (19)	21.5 (18.8)	21.2 (18.5)	20.7 (17.9)	19.8 (17.2)
5	960	4.17	21.1 (18.4)	21 (18)	20.7 (17.9)	20.4 (17.7)	19.8 (17.1)	19 (16.3)
2	2400	1.67	20.4 (17.6)	20.3 (17.3)	20 (17.2)	19.6 (16.7)	19.1 (16.4)	18.3 (15.5)
1	4800	0.83	18.6 (15.8)	18.5 (15.7)	18.4 (15.7)	18.3 (15.4)	18.1 (15.4)	17.6 (14.9)

¹ The output peak-to-peak (p-p) resolution is listed in parentheses.

SINC³ CHOP DISABLED**Table 9. RMS Noise (nV) vs. Gain and Output Data Rate**

Filter Word (Decimal)	Output Data Rate (Hz)	Settling Time (ms)	Gain of					
			1	8	16	32	64	128
1023	4.7	639.4	380	58	35	20	13	11
640	7.5	400	450	73	41	25	17	14
480	10	300	490	90	47	28	19	16
96	50	60	1100	160	92	54	40	36
80	60	50	1200	170	99	59	43	39
32	150	20	1900	280	160	91	72	63
16	300	10	2700	380	210	130	97	87
5	960	3.13	6400	870	490	280	200	170
2	2400	1.25	115,000	14,000	7000	3600	1800	950
1	4800	0.625	860,000	110,000	54,000	28,000	14,000	7000

Table 10. Peak-to-Peak Noise (nV) vs. Gain and Output Data Rate

Filter Word (Decimal)	Output Data Rate (Hz)	Settling Time (ms)	Gain of					
			1	8	16	32	64	128
1023	4.7	639.4	2300	350	220	130	84	70
640	7.5	400	2700	450	270	160	110	88
480	10	300	3100	520	310	180	120	100
96	50	60	7200	990	560	370	260	230
80	60	50	7800	1100	630	390	270	250
32	150	20	13,000	1800	1000	580	480	400
16	300	10	19,000	2500	1400	860	640	560
5	960	3.13	410,000	5700	3200	1800	1300	1100
2	2400	1.25	730,000	93,000	47,000	24,000	12,000	6100
1	4800	0.625	5,700,000	730,000	360,000	180,000	93,000	45,000

Table 11. Effective Resolution (Peak-to-Peak Resolution) vs. Gain and Output Data Rate

Filter Word (Decimal)	Output Data Rate (Hz)	Settling Time (ms)	Gain of ¹					
			1	8	16	32	64	128
1023	4.7	639.4	24 (22.1)	24 (21.8)	24 (21.4)	23.9 (21.2)	23.5 (20.8)	22.8 (20.1)
640	7.5	400	24 (21.8)	24 (21.4)	23.9 (21.1)	23.6 (20.9)	23.1 (20.4)	22.4 (19.8)
480	10	300	24 (21.6)	23.8 (21.2)	23.7 (20.9)	23.4 (20.7)	23 (20.3)	22.2 (19.6)
96	50	60	23.1 (20.4)	22.9 (20.3)	22.7 (20.1)	22.5 (19.7)	21.9 (19.2)	21 (18.4)
80	60	50	23 (20.3)	22.8 (20.1)	22.6 (19.9)	22.3 (19.6)	21.8 (19.1)	20.9 (18.3)
32	150	20	22.3 (19.6)	22.1 (19.4)	21.9 (19.3)	21.7 (19)	21 (18.3)	20.2 (17.6)
16	300	10	21.8 (19)	21.6 (18.9)	21.56 (18.8)	21.2 (18.5)	20.6 (17.9)	19.8 (17.1)
5	960	3.13	20.6 (17.9)	20.5 (17.7)	20.3 (17.6)	20.1 (17.4)	19.6 (16.9)	18.8 (16.1)
2	2400	1.25	16.5 (13.7)	16.4 (13.7)	16.4 (13.7)	16.4 (13.7)	16.4 (13.7)	16.4 (13.6)
1	4800	0.625	13.5 (10.8)	13.5 (10.7)	13.5 (10.7)	13.5 (10.7)	13.5 (10.7)	13.5 (10.7)

¹ The output peak-to-peak (p-p) resolution is listed in parentheses.

FAST SETTLING

Table 12. RMS Noise (nV) vs. Gain and Output Data Rate

Filter Word (Decimal)	Average	Output Data Rate (Hz)	Settling Time (ms)	Gain of					
				1	8	16	32	64	128
96	16	2.63	380	410	87	52	33	15	12
30	16	8.4	118.75	700	140	71	43	30	21
6	16	42.10	23.75	1500	270	150	82	56	47
5	16	50.53	19.79	1600	280	160	88	61	52
2	16	126.32	7.92	2700	380	210	130	94	85
1	16	252.63	3.96	3700	540	300	190	140	120

Table 13. Peak-to-Peak Noise (nV) vs. Gain and Output Data Rate

Filter Word (Decimal)	Average	Output Data Rate (Hz)	Settling Time (ms)	Gain of					
				1	8	16	32	64	128
96	16	2.63	380	2500	450	260	180	100	70
30	16	8.4	118.75	4200	900	470	280	190	130
6	16	42.10	23.75	10,000	1800	950	540	360	300
5	16	50.53	19.79	11,000	1900	1000	580	390	330
2	16	126.32	7.92	16,000	2800	1500	850	580	510
1	16	252.63	3.96	23,000	4500	2000	1200	850	740

Table 14. Effective Resolution (Peak-to-Peak Resolution) vs. Gain and Output Data Rate

Filter Word (Decimal)	Average	Output Data Rate (Hz)	Settling Time (ms)	Gain of ¹					
				1	8	16	32	64	128
96	16	2.63	380	24 (21.9)	23.8 (21.4)	23.5 (21.2)	23.2 (20.7)	23.3 (20.6)	22.6 (20.1)
30	16	8.4	118.75	23.8 (21.2)	23.1 (20.4)	23.1 (20.3)	22.8 (20.1)	22.3 (19.6)	21.8 (19.2)
6	16	42.10	23.75	22.7 (19.9)	22.1 (19.4)	22 (19.3)	21.9 (19.1)	21.4 (18.7)	20.7 (18)
5	16	50.53	19.79	22.6 (19.8)	22.1 (19.3)	21.9 (19.3)	21.8 (19)	21.3 (18.6)	20.5 (17.9)
2	16	126.32	7.92	21.8 (19.3)	21.6 (18.8)	21.5 (18.7)	21.2 (18.5)	20.7 (18)	19.8 (17.2)
1	16	252.63	3.96	21.4 (18.7)	21.1 (18.1)	21 (18.3)	20.6 (18)	20.1 (17.5)	19.3 (16.7)

¹ The output peak-to-peak (p-p) resolution is listed in parentheses.

ON-CHIP REGISTERS

The ADC is controlled and configured via a number of on-chip registers that are described on the following pages wherein the term, set, implies a Logic 1 state and cleared implies a Logic 0 state, unless otherwise noted.

Table 15. Register Summary

Register	Addr.	Dir.	Default	Bit 7	Bit 6	Bit 5	Bit 4	Bit 3	Bit 2	Bit 1	Bit 0
Communications	00	W	00	0	R/W	Register address			CREAD	0	0
Status	00	R	80	RDY	ERR	NOREF	Parity	CHD3	CHD2	CHD1	CHD0
Mode	01	R/W	080060	Mode select			DAT_STA	CLK1	CLK0	AVG1	AVG0
				SINC3	0	ENPAR	CLK_DIV	Single	REJ60	FS9	FS8
				FS7	FS6	FS5	FS4	FS3	FS2	FS1	FS0 (LSB)
Configuration	02	R/W	000117	Chop (MSB)	0	0	REFSEL	0	Pseudo	0	TEMP
				CH7(CH6	CH5	CH4	CH3	CH2	CH1	CH0
				Burn	REFDET	0	BUF	U/B	G2	G1	G0 (LSB)
Data	03	R	000000	D23 (MSB)	D22	D21	D20	D19	D18	D17	D16
				D15	D14	D13	D12	D11	D10	D9	D8
				D7	D6	D5	D4	D3	D2	D1	D0 (LSB)
ID	04	R	X3	X	X	X	X	0	0	1	1
GPOCON	05	R/W	00	0	0	GP32EN	GP10EN	P3DAT	P2DAT	P1DAT	PODAT
Offset	06	R/W	800000	OF23 (MSB)	OF22	OF21	OF20	OF19	OF18	OF17	OF16
				OF15	OF14	OF13	OF12	OF11	OF10	OF9	OF8
				OF7	OF6	OF5	OF4	OF3	OF2	OF1	OF0 (LSB)
Full Scale	07	R/W	5XXXX0	FS23 (MSB)	FS22	FS21	FS20	FS19	FS18	FS17	FS16
				FS15	FS14	FS13	FS12	FS11	FS10	FS9	FS8
				FS7	FS6	FS5	FS4	FS3	FS2	FS1	FS0 (LSB)

COMMUNICATIONS REGISTER**RS2, RS1, RS0 = 000**

The communications register is an 8-bit write-only register. All communications to the part must start with a write operation to the communications register. The data written to the communications register determine whether the next operation is a read or write operation and in which register this operation occurs. For read or write operations, when the subsequent read or write operation to the selected register is complete, the interface returns to where it expects a write operation to the communications register. This is the default state of the interface and, on power-up or after

a reset, the ADC is in this default state waiting for a write operation to the communications register. In situations where the interface sequence is lost, a write operation of at least 40 serial clock cycles with DIN high returns the ADC to this default state by resetting the entire part. Table 16 outlines the bit designations for the communications register. CR0 through CR7 indicate the bit location, CR denoting that the bits are in the communications register. CR7 denotes the first bit of the data stream. The number in parentheses indicates the power-on/reset default status of that bit.

CR7	CR6	CR5	CR4	CR3	CR2	CR1	CR0
WEN(0)	R/W(0)	RS2(0)	RS1(0)	RS0(0)	CREAD(0)	0(0)	0(0)

Table 16. Communications Register (CR) Bit Designations

Bit Location	Bit Name	Description
CR7	WEN	Write enable bit. For a write to the communications register to occur, 0 must be written to this bit. If a 1 is the first bit written, the part does not clock onto subsequent bits in the register; rather, it stays at this bit location until a 0 is written to this bit. After a 0 is written to the WEN bit, the next seven bits are loaded to the communications register. Idling the DIN pin high between data transfers minimizes the effects of spurious SCLK pulses on the serial interface.
CR6	R/W	0 in this bit location indicates that the next operation is a write to a specified register. 1 in this bit position indicates that the next operation is a read from the designated register.
CR5 to CR3	RS2 to RS0	Register address bits. These address bits are used to select which registers of the ADC are selected during the serial interface communication (see Table 17).
CR2	CREAD	Continuous read of the data register. When this bit is set to 1 (and the data register is selected), the serial interface is configured so that the data register can be continuously read; that is, the contents of the data register are automatically placed on the DOUT pin when the SCLK pulses are applied after the RDY pin goes low to indicate that a conversion is complete. The communications register does not have to be written to for subsequent data reads. To enable continuous read, Instruction 01011100 must be written to the communications register. To disable continuous read, Instruction 01011000 must be written to the communications register while the RDY pin is low. While continuous read is enabled, the ADC monitors activity on the DIN line so that it can receive the instruction to disable continuous read. Additionally, a reset occurs if 40 consecutive 1s occur on DIN; therefore, hold DIN low until an instruction is written to the device.
CR1 to CR0	0	These bits must be programmed to Logic 0 for correct operation.

Table 17. Register Selection

RS2	RS1	RS0	Register	Register Size
0	0	0	Communications register during a write operation	8 bits
0	0	0	Status register during a read operation	8 bits
0	0	1	Mode register	24 bits
0	1	0	Configuration register	24 bits
0	1	1	Data register/data register plus status information	24 bits/32 bits
1	0	0	ID register	8 bits
1	0	1	GPOCON register	8 bits
1	1	0	Offset register	24 bits
1	1	1	Full-scale register	24 bits

STATUS REGISTER**RS2, RS1, RS0 = 000; Power-On/Reset = 0x80**

The status register is an 8-bit read-only register. To access the ADC status register, the user must write to the communications register, select the next operation to be a read operation, and

load Bit RS2, Bit RS1, and Bit RS0 with 0. Table 18 outlines the bit designations for the status register. SR0 through SR7 indicate the bit locations, SR denoting that the bits are in the status register. SR7 denotes the first bit of the data stream. The number in parentheses indicates the power-on/reset default status of that bit.

SR7	SR6	SR5	SR4	SR3	SR2	SR1	SR0
RDY(1)	ERR(0)	NOREF(0)	Parity(0)	CHD3(0)	CHD2(0)	CHD1(0)	CHD0(0)

Table 18. Status Register (SR) Bit Designations

Bit Location	Bit Name	Description
SR7	RDY	Ready bit for the ADC. This bit is cleared when data is written to the ADC data register. The RDY bit is set automatically after the ADC data register is read, or a period of time before the data register is updated, with a new conversion result to indicate to the user that the conversion data should not be read. It is also set when the part is placed in power-down mode or idle mode or when SYNC is taken low. The end of a conversion is also indicated by the DOUT/RDY pin. This pin can be used as an alternative to the status register for monitoring the ADC for conversion data.
SR6	ERR	ADC error bit. This bit is written to at the same time as the RDY bit. This bit is set to indicate that the result written to the ADC data register is clamped to all 0s or all 1s. Error sources include overrange, underrange, or the absence of a reference voltage. This bit is cleared when the result written to the data register returns to within the allowed analog input range. The ERR bit is also set during calibrations if the reference source is invalid or if the applied analog input voltages are outside range during system calibrations.
SR5	NOREF	No external reference bit. This bit is set to indicate that the selected reference (REFIN1 or REFIN2) is at a voltage that is below a specified threshold. When set, conversion results are clamped to all 1s. This bit is cleared to indicate that a valid reference is applied to the selected reference pins. The NOREF bit is enabled by setting the REFDET bit in the configuration register to 1.
SR4	Parity	Parity check of the data register. If the ENPAR bit in the mode register is set, the parity bit is set if there is an odd number of 1s in the data register. It is cleared if there is an even number of 1s in the data register. The DAT_STA bit in the mode register should be set when the parity check is used. When the DAT_STA bit is set, the contents of the status register are transmitted along with the data for each data register read.
SR3 to SR0	CHD3 to CHD0	These bits indicate which channel corresponds to the data register contents. They do not indicate which channel is presently being converted, but indicate which channel was selected when the conversion contained in the data register was generated.

MODE REGISTER**RS2, RS1, RS0 = 001; Power-On/Reset = 0x080060**

The mode register is a 24-bit register from which data can be read or to which data can be written. This register is used to select the operating mode, the output data rate, and the clock source. Table 19 outlines the bit designations for the mode

register. MR0 through MR23 indicate the bit locations, MR denoting that the bits are in the mode register. MR23 denotes the first bit of the data stream. The number in parentheses indicates the power-on/reset default status of that bit. Any write to the mode register resets the modulator and filter and sets the RDY bit.

MR23	MR22	MR21	MR20	MR19	MR18	MR17	MR16
MD2(0)	MD1(0)	MD0(0)	DAT_STA(0)	CLK1(1)	CLK0(0)	AVG1(0)	AVG0(0)
MR15	MR14	MR13	MR12	MR11	MR10	MR9	MR8
SINC3(0)	0	ENPAR(0)	CLK_DIV(0)	Single(0)	REJ60(0)	FS9(0)	FS8(0)
MR7	MR6	MR5	MR4	MR3	MR2	MR1	MR0
FS7(0)	FS6(1)	FS5(1)	FS4(0)	FS3(0)	FS2(0)	FS1(0)	FS0(0)

Table 19. Mode Register (MR) Bit Designations

Bit Location	Bit Name	Description															
MR23 to MR21	MD2 to MD0	Mode select bits. These bits select the operating mode of the AD7194 (see Table 20).															
MR20	DAT_STA	This bit enables the transmission of status register contents after each data register read. When DAT_STA is set, the contents of the status register are transmitted along with each data register read. This function is useful when several channels are selected because the status register identifies the channel to which the data register value corresponds.															
MR19, MR18	CLK1, CLK0	These bits select the clock source for the AD7194. Either the on-chip 4.92 MHz clock or an external clock can be used. The ability to use an external clock allows several AD7194 devices to be synchronized. Also, 50 Hz/60 Hz rejection is improved when an accurate external clock drives the AD7194.															
		<table border="1"> <thead> <tr> <th>CLK1</th> <th>CLK0</th> <th>ADC Clock Source</th> </tr> </thead> <tbody> <tr> <td>0</td> <td>0</td> <td>External crystal. The external crystal is connected from MCLK1 to MCLK2.</td> </tr> <tr> <td>0</td> <td>1</td> <td>External clock. The external clock is applied to the MCLK2 pin.</td> </tr> <tr> <td>1</td> <td>0</td> <td>Internal 4.92 MHz clock. Pin MCLK2 is tristated.</td> </tr> <tr> <td>1</td> <td>1</td> <td>Internal 4.92 MHz clock. The internal clock is available on MCLK2.</td> </tr> </tbody> </table>	CLK1	CLK0	ADC Clock Source	0	0	External crystal. The external crystal is connected from MCLK1 to MCLK2.	0	1	External clock. The external clock is applied to the MCLK2 pin.	1	0	Internal 4.92 MHz clock. Pin MCLK2 is tristated.	1	1	Internal 4.92 MHz clock. The internal clock is available on MCLK2.
CLK1	CLK0	ADC Clock Source															
0	0	External crystal. The external crystal is connected from MCLK1 to MCLK2.															
0	1	External clock. The external clock is applied to the MCLK2 pin.															
1	0	Internal 4.92 MHz clock. Pin MCLK2 is tristated.															
1	1	Internal 4.92 MHz clock. The internal clock is available on MCLK2.															
MR17, MR16	AVG1, AVG0	Fast settling filter. When this option is selected, the settling time equals one conversion time. In fast settling mode, a first-order average and decimate block is included after the sinc filter. The data from the sinc filter is averaged by 2, 8, or 16. The averaging reduces the output data rate for a given FS word; however, the rms noise improves. The AVG1 and AVG0 bits select the amount of averaging. Fast settling mode can be used for FS words less than 512 only. When the sinc ³ filter is selected, the FS word must be less than 256 when averaging by 16.															
		<table border="1"> <thead> <tr> <th>AVG1</th> <th>AVG0</th> <th>Average</th> </tr> </thead> <tbody> <tr> <td>0</td> <td>0</td> <td>No averaging (fast settling mode disabled)</td> </tr> <tr> <td>0</td> <td>1</td> <td>Average by 2</td> </tr> <tr> <td>1</td> <td>0</td> <td>Average by 8</td> </tr> <tr> <td>1</td> <td>1</td> <td>Average by 16</td> </tr> </tbody> </table>	AVG1	AVG0	Average	0	0	No averaging (fast settling mode disabled)	0	1	Average by 2	1	0	Average by 8	1	1	Average by 16
AVG1	AVG0	Average															
0	0	No averaging (fast settling mode disabled)															
0	1	Average by 2															
1	0	Average by 8															
1	1	Average by 16															
MR15	SINC3	Sinc ³ filter select bit. When this bit is cleared, the sinc ⁴ filter is used (default value). When this bit is set, the sinc ³ filter is used. The benefit of the sinc ³ filter compared to the sinc ⁴ filter is its lower settling time. For a given output data rate, f_{ADC} , the sinc ³ filter has a settling time of $3/f_{ADC}$ whereas the sinc ⁴ filter has a settling time of $4/f_{ADC}$ when chop is disabled. The sinc ⁴ filter, due to its deeper notches, gives better 50 Hz/60 Hz rejection. At low output data rates, both filters give similar rms noise and similar no missing codes for a given output data rate. At higher output data rates (FS values less than 5), the sinc ⁴ filter gives better performance than the sinc ³ filter for rms noise and no missing codes.															
MR14	0	This bit must be programmed with a Logic 0 for correct operation.															
MR13	ENPAR	Enable parity bit. When ENPAR is set, parity checking on the data register is enabled. The DAT_STA bit in the mode register should be set when the parity check is used. When the DAT_STA bit is set, the contents of the status register are transmitted along with the data for each data register read.															

Bit Location	Bit Name	Description
MR12	CLK_DIV	Clock divide-by-2. When CLK_DIV is set, the master clock is divided by 2. For normal conversions, set this bit to 0. When performing internal full-scale calibrations, this bit must be set when AV _{DD} is less than 4.75 V. The calibration accuracy is optimized when chop is enabled and a low output data rate is used while performing the calibration. When AV _{DD} is greater than or equal to 4.75 V, it is not compulsory to set the CLK_DIV bit when performing internal full-scale calibrations.
MR11	Single	Single cycle conversion enable bit. When this bit is set, the AD7194 settles in one conversion cycle so that it functions as a zero latency ADC. This bit has no effect when multiple analog input channels are enabled or when the single conversion mode is selected. If the fast-settling filter is enabled, this bit (single) does not have an effect on the conversions unless chopping is also enabled.
MR10	REJ60	This bit enables a notch at 60 Hz when the first notch of the sinc filter is at 50 Hz. When REJ60 is set, a filter notch is placed at 60 Hz when the sinc filter first notch is at 50 Hz. This allows simultaneous 50 Hz/60 Hz rejection.
MR9 to MR0	FS9 to FS0	<p>Filter output data rate select bits. The 10 bits of data programmed into these bits determine the filter cutoff frequency, the position of the first notch of the filter, and the output data rate for the part. In association with the gain selection, they also determine the output noise and, therefore, the effective resolution of the device (see Table 6 through Table 11).</p> <p>When chop is disabled, fast settling mode is disabled and continuous conversion mode is selected</p> $\text{Output Data Rate} = (\text{MCLK}/1024)/\text{FS}$ <p>where FS is the decimal equivalent of the code in Bit FS0 to Bit FS9 within the range of 1 to 1023, and MCLK is the master clock frequency.</p> <p>With a nominal MCLK of 4.92 MHz, this results in an output data rate from 4.69 Hz to 4.8 kHz. With chop disabled and fast settling mode disabled, the first notch frequency is equal to the output data rate when converting on a single channel.</p> <p>When chop is enabled (fast settling mode disabled)</p> $\text{Output Data Rate} = (\text{MCLK}/1024)/(N \times \text{FS})$ <p>where FS is the decimal equivalent of the code in Bit FS0 to Bit FS9 within the range of 1 to 1023, and MCLK is the master clock frequency.</p> <p>With a nominal MCLK of 4.92 MHz, this results in a conversion rate from 4.69/N Hz to 4.8/N kHz, where N is the order of the sinc filter. The first notch frequency of the sinc filter is equal to</p> $N \times \text{Output Data Rate}$ <p>The chopping introduces notches at odd integer multiples of</p> $\text{Output Data Rate}/2$

Table 20. Operating Modes (MD)

MD2	MD1	MD0	Mode
0	0	0	Continuous conversion mode (default). In continuous conversion mode, the ADC continuously performs conversions and places the result in the data register. The DOUT/RDY pin and the RDY bit in the status register go low when a conversion is complete. The user can read these conversions by setting the CREAD bit in the communications register to 1, which enables continuous read. When continuous read is enabled, the conversions are automatically placed on the DOUT line when SCLK pulses are applied. Alternatively, the user can instruct the ADC to output each conversion by writing to the communications register. After power-on, a reset, or a re-configuration of the ADC, the complete settling time of the filter is required to generate the first valid conversion. Subsequent conversions are available at the selected output data rate, which is dependent on filter choice.
0	0	1	Single conversion mode. When single conversion mode is selected, the ADC powers up and performs a single conversion on the selected channel. The internal clock requires 200 μ s typically to power up and settle. The ADC then performs the conversion, which requires the complete settling time of the filter. The conversion result is placed in the data register. RDY goes low, and the ADC returns to power-down mode. The conversion remains in the data register until another conversion is performed. RDY remains active (low) until the data is read or another conversion is performed.
0	1	0	Idle mode. In idle mode, the ADC filter and modulator are held in a reset state even though the modulator clocks continue to be provided.
0	1	1	Power-down mode. In power-down mode, all AD7194 circuitry is powered down. The external crystal, if selected, remains active.
1	0	0	Internal zero-scale calibration. An internal short is automatically connected to the input. RDY goes high when the calibration is initiated and returns low when the calibration is complete. The ADC is placed in idle mode following a calibration. The measured offset coefficient is placed in the offset register of the selected channel.
1	0	1	Internal full-scale calibration. A full-scale input voltage is automatically connected to the input for this calibration. RDY goes high when the calibration is initiated and returns low when the calibration is complete. The ADC is placed in idle mode following a calibration. The measured full-scale coefficient is placed in the full-scale register of the selected channel. A full-scale calibration is recommended each time that the gain of a channel is changed to minimize the full-scale error. When AV _{DD} is less than 4.75 V, the CLK_DIV bit must be set when performing the internal full-scale calibration.
1	1	0	System zero-scale calibration. The user should connect the system zero-scale input to the channel input pins as selected by the CH7 to CH0 bits in the configuration register. RDY goes high when the calibration is initiated and returns low when the calibration is complete. The ADC is placed in idle mode following a calibration. The measured offset coefficient is placed in the offset register of the selected channel. A system zero-scale calibration is recommended each time that the gain of a channel is changed.
1	1	1	System full-scale calibration. The user should connect the system full-scale input to the channel input pins as selected by the CH7 to CH0 bits in the configuration register. RDY goes high when the calibration is initiated and returns low when the calibration is complete. The ADC is placed in idle mode following a calibration. The measured full-scale coefficient is placed in the full-scale register of the selected channel. A full-scale calibration is recommended each time the gain of a channel is changed.

CONFIGURATION REGISTER***RS2, RS1, RS0 = 010; Power-On/Reset = 0x000117***

The configuration register is a 24-bit register from which data can be read or to which data can be written. This register is used to configure the ADC for unipolar or bipolar mode, to enable or disable the buffer, to enable or disable the burnout currents, to select the gain, and to select the analog input channel.

Table 21 outlines the bit designations for the configuration register. CON0 through CON23 indicate the bit locations. CON denotes that the bits are in the configuration register. CON23 denotes the first bit of the data stream. The number in parentheses indicates the power-on/reset default status of that bit.

CON23	CON22	CON21	CON20	CON19	CON18	CON17	CON16
Chop(0)	0(0)	0(0)	REFSEL(0)	0(0)	Pseudo(0)	0(0)	Temp(0)
CON15	CON14	CON13	CON12	CON11	CON10	CON9	CON8
CH7(0)	CH6(0)	CH5(0)	CH4(0)	CH3(0)	CH2(0)	CH1(0)	CH0(1)
CON7	CON6	CON5	CON4	CON3	CON2	CON1	CON0
Burn(0)	REFDET(0)	0(0)	BUF(1)	U/B̄(0)	G2(1)	G1(1)	G0(1)

Table 21. Configuration Register Bit Designations

Bit Location	Bit Name	Description				
CON23	Chop	Chop enable bit. When the chop bit is cleared, chop is disabled. With chop disabled, higher conversion rates are allowed. For an FS word of 96 decimal and the sinc ⁴ filter selected, the conversion time is 20 ms and the settling time is 80 ms. However, at low gains, periodic calibrations may be required to remove the offset and offset drift. When the chop bit is set, chop is enabled. When chop is enabled, the offset and offset drift of the ADC are continuously removed. However, this increases the conversion time and settling time of the ADC. For example, when FS = 96 decimal and the sinc ⁴ filter is selected, the conversion time with chop enabled equals 80 ms and the settling time equals 160 ms.				
CON22, CON21	0	These bits must be programmed with a Logic 0 for correct operation.				
CON20	REFSEL	Reference select bits. The reference source for the ADC is selected using these bits.				
		REFSEL	Reference Voltage			
		0	External reference applied between REFIN1(+) and REFIN1(-).			
1	External reference applied between the AIN3/P1/REFIN2(+) and AIN4/P0/REFIN2(-) pins.					
CON19	0	This bit must be programmed with a Logic 0 for correct operation.				
CON18	Pseudo	Pseudo differential analog inputs. When the pseudo bit is set to 1, the AD7194 is configured to have 16 pseudo differential analog inputs with AINCOM as the common negative terminal. Bits CH7 to CH4 select the positive input terminal while bits CH3 to CH0 have no effect. When the pseudo bit is set to 0, channel selection is controlled using the CH7 to CH0 bits.				
CON17	0	This bit must be programmed with a Logic 0 for correct operation.				
CON16	Temp	Temperature sensor select bit. When the Temp bit is set to 1, the internal temperature sensor is selected. When the Temp bit is low, the analog input channel as determined by the Pseudo bit and the CH7 to CH0 bits is selected. The temperature sensor does not have a unique code in bits CHD3 to CHD0 of the status register.				
CON16 to CON8	CH7 to CH0	Channel select bits. These bits select which channel is enabled on the AD7194 (see Table 22 to Table 24). The conversion on each channel requires the complete settling time. The four LSBs of the status register indicate the channel corresponding to the conversion in the data register. The four LSBs correspond to bits CH7 to CH3, that is, the positive analog input terminal.				
CON7	Burn	When this bit is set to 1, the 500 nA current sources in the signal path are enabled. When Burn = 0, the burnout currents are disabled. The burnout currents can be enabled only when the buffer is active and when chop is disabled.				
CON6	REFDET	Enables the reference detect function. When set, the NOREF bit in the status register indicates when the external reference being used by the ADC is open circuit or less than 0.6 V maximum. The reference detect circuitry operates only when the ADC is active.				
CON5	0	This bit must be programmed with a Logic 0 for correct operation.				
CON4	BUF	Enables the buffer on the analog inputs. If BUF is set, the analog inputs are buffered, allowing the user to place source impedances on the front end without contributing gain errors to the system. When the buffer is enabled, it requires some headroom; therefore, the voltage on any input pin must be limited to 250 mV within the power supply rails. If cleared, the analog inputs are unbuffered, lowering the power consumption of the device. With the buffer disabled, the voltage on the analog input pins can be from 50 mV below AGND to 50 mV above AV _{DD} .				
CON3	U/B	Polarity select bit. When this bit is set, unipolar operation is selected. When this bit is cleared, bipolar operation is selected.				
CON2 to CON0	G2 to G0	Gain select bits. These bits are written by the user to select the ADC input range as follows:				
		G2	G1	G0	Gain	ADC Input Range (2.5 V Reference)
		0	0	0	1	±2.5 V
		0	0	1	Reserved	
		0	1	0	Reserved	
		0	1	1	8	±312.5 mV
		1	0	0	16	±156.2 mV
		1	0	1	32	±78.125 mV
		1	1	0	64	±39.06 mV
1	1	1	128	±19.53 mV		

Channel Selection (Pseudo Bit = 0)

Table 22. Positive Input Selection

Positive Input Enable Bits in the Configuration Register				Positive Input Enabled AIN(+)	Status Register Bits CHD[3:0]
CH7	CH6	CH5	CH4		
0	0	0	0	AIN1	0000
0	0	0	1	AIN2	0001
0	0	1	0	AIN3	0010
0	0	1	1	AIN4	0011
0	1	0	0	AIN5	0100
0	1	0	1	AIN6	0101
0	1	1	0	AIN7	0110
0	1	1	1	AIN8	0111
1	0	0	0	AIN9	1000
1	0	0	1	AIN10	1001
1	0	1	0	AIN11	1010
1	0	1	1	AIN12	1011
1	1	0	0	AIN13	1100
1	1	0	1	AIN14	1101
1	1	1	0	AIN15	1110
1	1	1	1	AIN16	1111

Table 23. Negative Input Selection

Negative Input Enable Bits in the Configuration Register				Negative Input Enabled AIN(-)
CH3	CH2	CH1	CH0	
0	0	0	0	AIN1
0	0	0	1	AIN2
0	0	1	0	AIN3
0	0	1	1	AIN4
0	1	0	0	AIN5
0	1	0	1	AIN6
0	1	1	0	AIN7
0	1	1	1	AIN8
1	0	0	0	AIN9
1	0	0	1	AIN10
1	0	1	0	AIN11
1	0	1	1	AIN12
1	1	0	0	AIN13
1	1	0	1	AIN14
1	1	1	0	AIN15
1	1	1	1	AIN16

Table 24. Channel Selection (Pseudo Bit = 1)

Channel Enable Bits in the Configuration Register								Channel Enabled		Status Register Bits CHD[3:0]
CH7	CH6	CH5	CH4	CH3	CH2	CH1	CH0	Positive Input AIN(+)	Negative Input AIN(-)	
0	0	0	0	X	X	X	X	AIN1	AINCOM	0000
0	0	0	1	X	X	X	X	AIN2	AINCOM	0001
0	0	1	0	X	X	X	X	AIN3	AINCOM	0010
0	0	1	1	X	X	X	X	AIN4	AINCOM	0011
0	1	0	0	X	X	X	X	AIN5	AINCOM	0100
0	1	0	1	X	X	X	X	AIN6	AINCOM	0101
0	1	1	0	X	X	X	X	AIN7	AINCOM	0110
0	1	1	1	X	X	X	X	AIN8	AINCOM	0111
1	0	0	0	X	X	X	X	AIN9	AINCOM	1000
1	0	0	1	X	X	X	X	AIN10	AINCOM	1001
1	0	1	0	X	X	X	X	AIN11	AINCOM	1010
1	0	1	1	X	X	X	X	AIN12	AINCOM	1011
1	1	0	0	X	X	X	X	AIN13	AINCOM	1100
1	1	0	1	X	X	X	X	AIN14	AINCOM	1101
1	1	1	0	X	X	X	X	AIN15	AINCOM	1110
1	1	1	1	X	X	X	X	AIN16	AINCOM	1111

DATA REGISTER**RS2, RS1, RS0 = 011; Power-On/Reset = 0x000000**

The conversion result from the ADC is stored in this data register. This is a read-only, 24-bit register. Upon completion of a read operation from this register, the $\overline{\text{RDY}}$ pin/bit is set. When the DAT_STA bit in the mode register is set to 1, the contents of the status register are appended to each 24-bit conversion. This is advisable when several analog input channels are enabled because the four LSBs of the status register (CHD3 to CHD0) identify the channel from which the conversion originated.

ID REGISTER**RS2, RS1, RS0 = 100; Power-On/Reset = 0xX3**

The identification number for the AD7194 is stored in the ID register. This is a read-only register.

GPOCON REGISTER**RS2, RS1, RS0 = 101; Power-On/Reset = 0x00**

The GPOCON register is an 8-bit register from which data can be read or to which data can be written. This register is used to enable the general-purpose digital outputs.

Table 25 outlines the bit designations for the GPOCON register. GP0 through GP7 indicate the bit locations. GP denotes that the bits are in the GPOCON register. GP7 denotes the first bit of the data stream. The number in parentheses indicates the power-on/reset default status of that bit.

GP7	GP6	GP5	GP4	GP3	GP2	GP1	GP0
0(0)	0(0)	GP32EN(0)	GP10EN(0)	P3DAT(0)	P2DAT(0)	P1DAT(0)	P0DAT(0)

Table 25. Register Bit Designations

Bit Location	Bit Name	Description
GP7, GP6	0	These bits must be programmed with a Logic 0 for proper operation.
GP5	GP32EN	Digital Output P3 and Digital Output P2 enable. When GP32EN is set, the P3 and P2 digital outputs are active. When GP32EN is cleared, Pin P3 functions as analog input Pin AIN1 and Pin P2 functions as analog input Pin AIN2.
GP4	GP10EN	Digital Output P1 and Digital Output P0 enable. When GP10EN is set, the P1 and P0 digital outputs are active. When GP10EN is cleared, the P1 and P0 outputs are tristated, and the P1DAT and P0DAT bits are ignored. The P1 and P0 pins can be used as a reference input, REFIN2, when the REFSEL bit in the configuration register is set to 1. When GP10EN is cleared and Bit REFSEL is cleared, Pin P1 functions as analog input Pin AIN3 while Pin P0 functions as analog input Pin AIN4.
GP3	P3DAT	Digital Output P3. When GP32EN is set, the P3DAT bit sets the value of the P3 general-purpose output pin. When P3DAT is high, the P3 output pin is high. When P3DAT is low, the P3 output pin is low. When the GPOCON register is read, the P3DAT bit reflects the status of the P3 pin if GP32EN is set.
GP2	P2DAT	Digital Output P2. When GP32EN is set, the P2DAT bit sets the value of the P2 general-purpose output pin. When P2DAT is high, the P2 output pin is high. When P2DAT is low, the P2 output pin is low. When the GPOCON register is read, the P2DAT bit reflects the status of the P2 pin if GP32EN is set.
GP1	P1DAT	Digital Output P1. When GP10EN is set, the P1DAT bit sets the value of the P1 general-purpose output pin. When P1DAT is high, the P1 output pin is high. When P1DAT is low, the P1 output pin is low. When the GPOCON register is read, the P1DAT bit reflects the status of the P1 pin if GP10EN is set.
GP0	P0DAT	Digital Output P0. When GP10EN is set, the P0DAT bit sets the value of the P0 general-purpose output pin. When P0DAT is high, the P0 output pin is high. When P0DAT is low, the P0 output pin is low. When the GPOCON register is read, the P0DAT bit reflects the status of the P0 pin if GP10EN is set.

OFFSET REGISTER***RS2, RS1, RS0 = 110; Power-On/Reset = 0x800000***

The offset register holds the offset calibration coefficient for the ADC. The power-on reset value of the offset register is 0x800000. The register is a 24-bit read/write register. It is used in conjunction with the full-scale register to form a register pair. The power-on reset value is automatically overwritten if an internal or system zero-scale calibration is initiated by the user. The AD7194 must be placed in power-down mode or idle mode when writing to the offset register.

FULL-SCALE REGISTER***RS2, RS1, RS0 = 111; Power-On/Reset = 0x5XXXX0***

The full-scale register is a 24-bit register that holds the full-scale calibration coefficient for the ADC. The full-scale register is a read/write register. However, when writing to the full-scale register, the ADC must be placed in power-down mode or idle mode. The register is configured at power-on with a factory calibrated full-scale calibration coefficient, the calibration being performed at gain = 1. Therefore, every device has different default coefficients. The default value is automatically overwritten if an internal or system full-scale calibration is initiated by the user or if the full-scale register is written to.

ADC CIRCUIT INFORMATION

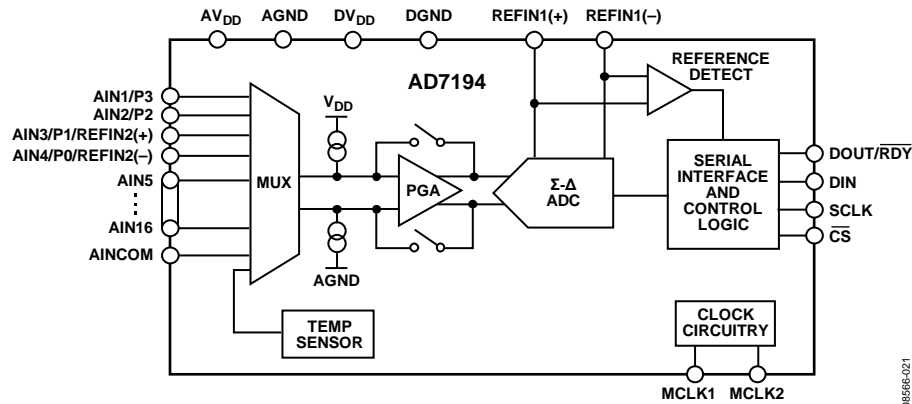

Figure 21. Basic Connection Diagram

OVERVIEW

The AD7194 is an ultralow noise ADC that incorporates a sigma-delta (Σ - Δ) modulator, a buffer, PGA, and on-chip digital filtering intended for the measurement of wide dynamic range signals such as those in pressure transducers, weigh scales, and strain gage applications. Figure 21 shows the basic connections required to operate the part.

Analog Inputs

The device can be configured to have eight differential or sixteen pseudo differential analog inputs. The analog inputs can be buffered or unbuffered. The AD7194 uses flexible multiplexing, thus any analog input pin can be selected as a positive input and any analog input pin can be selected as a negative input.

Multiplexer

The on-chip multiplexer increases the channel count of the device. Because the multiplexer is included on chip, any channel changes are synchronized with the conversion process.

PGA

The analog input signal can be amplified using the PGA. The PGA allows gains of 1, 8, 16, 32, 64, and 128.

Reference Detect

The AD7194 is capable of monitoring the external reference. If the reference is not present, a flag is set in the status register of the device.

Burnout Currents

Two 500 nA burnout currents are included on-chip to detect the presence of the external sensor.

Σ - Δ ADC and Filter

The AD7194 contains a fourth-order Σ - Δ modulator followed by a digital filter.

The device has several filter options:

- Sinc⁴
- Sinc³
- Chop enabled/disabled
- Fast settling
- Zero latency

Serial Interface

The AD7194 has a 4-wire SPI. The on-chip registers are accessed via the serial interface.

Clock

The AD7194 has an internal 4.92 MHz clock. Either this clock or an external clock can be used as the clock source to the AD7194. The internal clock can also be made available on a pin if a clock source is required for external circuitry.

Temperature Sensor

The on-chip temperature sensor monitors the die temperature.

Digital Outputs

The AD7194 has four general-purpose digital outputs. These can be used for driving external circuitry. For example, an external multiplexer can be controlled by these outputs.

Calibration

Both internal and system calibration are included on chip; therefore, the user has the option of removing offset/gain errors internal to the AD7194 only, or removing the offset/gain errors of the complete end system.

ANALOG INPUT CHANNEL

The AD7194 uses flexible multiplexing so any of the analog input pins AIN1 to AIN16 can be selected as a positive input or a negative input (see Table 22 and Table 23). The AINCOM pin can be a negative analog input pin only.

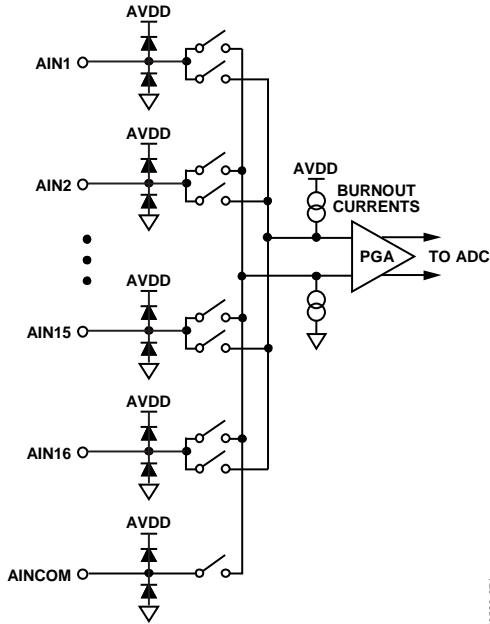

Figure 22. Analog Input Multiplexer Circuit

The channels are configured using bits CH7 to CH0 and bit Pseudo in the configuration register (See Table 22 to Table 24). The device can be configured to have eight differential inputs, sixteen pseudo-differential inputs or a combination of both. The inputs can be buffered or unbuffered. In the buffered mode (the BUF bit in the configuration register is set to 1), the input channel feeds into a high impedance input stage of the buffer amplifier. Therefore, the input can tolerate significant source impedances and is tailored for direct connection to external resistive type sensors such as strain gages or resistance temperature detectors (RTDs).

When BUF = 0, the part is operated in the unbuffered mode. This results in a higher analog input current. Note that this unbuffered input path provides a dynamic load to the driving source. Therefore, resistor/capacitor combinations on the input pins can cause gain errors, depending on the output impedance of the source that is driving the ADC input. Table 26 shows the allowable external resistance/capacitance values for unbuffered mode at a gain of 1 such that no gain error at the 18-bit level is introduced.

Table 26. External R-C Combination for No 18-Bit Gain Error

C (pF)	R (Ω)
50	1.4 k
100	850
500	300
1000	230
5000	30

The absolute input voltage range in buffered mode is restricted to a range between AGND + 250 mV and AV_{DD} – 250 mV. Care must be taken in setting up the common-mode voltage to not exceed these limits; otherwise, linearity and noise performance degrade.

The absolute input voltage in unbuffered mode includes the range between AGND – 50 mV and AV_{DD} + 50 mV. The negative absolute input voltage limit allows the possibility of monitoring small true bipolar signals with respect to AGND.

PROGRAMMABLE GAIN ARRAY (PGA)

When the gain stage is enabled, the output from the buffer is applied to the input of the PGA. The presence of the PGA means that signals of small amplitude can be gained within the AD7194 and still maintain excellent noise performance. For example, when the gain is set to 128, the rms noise is 11 nV, typically, when the output data rate is 4.7 Hz, which is equivalent to 22.7 bits of effective resolution or 20 bits of noise-free resolution.

The AD7194 can be programmed to have a gain of 1, 8, 16, 32, 64, and 128 by using Bit G2 to Bit G0 in the configuration register. Therefore, with an external 2.5 V reference, the unipolar ranges are from 0 mV to 19.53 mV to 0 V to 2.5 V, and the bipolar ranges are from ± 19.53 mV to ± 2.5 V.

The analog input range must be limited to $\pm(AV_{DD} - 1.25 \text{ V})/\text{gain}$ because the PGA requires some headroom. Therefore, if V_{REF} = AV_{DD} = 5 V, the maximum analog input that can be applied to the AD7194 is 0 V to 3.75 V/gain in unipolar mode or ± 3.75 V/gain in bipolar mode.

REFERENCE

The ADC has a fully differential input capability for the reference channel. In addition, the user has the option of selecting one of two external reference options (REFIN1(\pm) or REFIN2(\pm)). The reference source for the AD7194 is selected using the REFSEL bit in the configuration register. The REFIN2(\pm) pins are dual purpose: they can function as two general-purpose output pins or as reference pins. When the REFSEL bit is set to 1, these pins automatically function as reference pins.

The common-mode range for these differential inputs is from AGND to AV_{DD}. The reference voltage REFIN (REFIN_x(+) – REFIN_x(–)) is AV_{DD} nominal, but the AD7194 is functional with reference voltages from 1 V to AV_{DD}. In applications where the excitation (voltage or current) for the transducer on the analog input also drives the reference voltage for the part, the effect of the low frequency noise in the excitation source is removed because the application is ratiometric. If the AD7194 is used in a nonratiometric application, a low noise reference should be used.

The reference input is unbuffered; therefore, excessive R-C source impedances introduce gain errors. R-C values similar to those in Table 26 are recommended for the reference inputs. Deriving the reference input voltage across an external resistor means that the reference input sees significant external source

impedance. External decoupling on the REFINx pins is not recommended in this type of circuit configuration. Conversely, if large decoupling capacitors are used on the reference inputs, there should be no resistors in series with the reference inputs.

Recommended 2.5 V reference voltage sources for the AD7194 include the [ADR421](#) and [ADR431](#), which are low noise references. These references tolerate decoupling capacitors on REFINx(+) without introducing gain errors in the system. Figure 23 shows the recommended connections between the ADR421 and the AD7194.

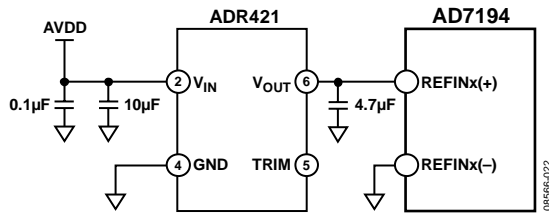

Figure 23. ADR421 to AD7194 Connections

REFERENCE DETECT

The AD7194 includes on-chip circuitry to detect whether the part has a valid reference for conversions or calibrations. This feature is enabled when the REFDET bit in the configuration register is set to 1. If the voltage between the selected REFINx(+) and REFINx(-) pins is less than 0.3 V, the AD7194 detects that it no longer has a valid reference. In this case, the NOREF bit of the status register is set to 1. When the voltage between the selected REFINx(+) and REFINx(-) pins is greater than 0.6 V, the AD7194 detects a valid reference; thus, the NOREF bit is set to 0. The operation of the NOREF bit is undefined when the voltage between the selected REFINx(+) and REFINx(-) pins is between 0.3 V and 0.6 V.

If the AD7194 is performing normal conversions and the NOREF bit becomes active, the conversion result is all 1s. Therefore, it is not necessary to continuously monitor the status of the NOREF bit when performing conversions. It is only necessary to verify its status if the conversion result read from the ADC data register is all 1s.

If the AD7194 is performing either an offset or full-scale calibration and the NOREF bit becomes active, the updating of the respective calibration registers is inhibited to avoid loading incorrect coefficients to these registers, and the ERR bit in the status register is set. If the user is concerned about verifying that a valid reference is in place every time a calibration is performed, the status of the ERR bit should be checked at the end of the calibration cycle.

BIPOLAR/UNIPOLAR CONFIGURATION

The analog input to the AD7194 can accept either unipolar or bipolar input voltage ranges. A bipolar input range does not imply that the part can tolerate negative voltages with respect to system AGND. In pseudo differential mode, signals are referenced to AINCOM, whereas in differential mode, signals are referenced to the negative input of the differential pair. For example, if AINCOM is 2.5 V and the AD7194 AIN1 analog

input is configured for unipolar mode with a gain of 2, the input voltage range on the AIN1 pin is 2.5 V to 3.75 V when a 2.5 V reference is used.

If AINCOM is 2.5 V and the AD7194 AIN1 analog input is configured for bipolar mode with a gain of 2, the analog input range on AIN1 is 1.25 V to 3.75 V. The bipolar/unipolar option is chosen by programming the U/B bit in the configuration register.

DATA OUTPUT CODING

When the ADC is configured for unipolar operation, the output code is natural (straight) binary with a zero differential input voltage resulting in a code of 00...00, a midscale voltage resulting in a code of 100...000, and a full-scale input voltage resulting in a code of 111...111. The output code for any analog input voltage can be represented as

$$\text{Code} = (2^N \times \text{AIN} \times \text{Gain}) / V_{REF}$$

When the ADC is configured for bipolar operation, the output code is offset binary with a negative full-scale voltage resulting in a code of 000...000, a zero differential input voltage resulting in a code of 100...000, and a positive full-scale input voltage resulting in a code of 111...111. The output code for any analog input voltage can be represented as

$$\text{Code} = 2^{(N-1)} \times [(\text{AIN} \times \text{Gain} / V_{REF}) + 1]$$

where:

AIN is the analog input voltage.

Gain is the PGA setting (1 to 128).

N = 24.

BURNOUT CURRENTS

The AD7194 contains two 500 nA constant current generators, one sourcing current from AV_{DD} to AIN(+) and one sinking current from AIN(-) to AGND. The currents are switched to the selected analog input pair. Both currents are either on or off, depending on the burnout current enable (burn) bit in the configuration register.

These currents can be used to verify that an external transducer remains operational before attempting to take measurements on that channel. After the burnout currents are turned on, they flow in the external transducer circuit, and a measurement of the input voltage on the analog input channel can be taken. It takes some time for the burnout currents to detect an open circuit condition because the currents must charge any external capacitors.

There are several reasons that a fault condition is detected: the front-end sensor may be either open circuit or overloaded, or the reference may be absent and the NOREF bit in the status register is set, thus clamping the data to all 1s. The user must check these three cases before making a determination.

If the voltage measured is 0 V, it may indicate that the transducer has short circuited. The current sources work over the normal absolute input voltage range specifications when the analog inputs are buffered and chop is disabled.

DIGITAL INTERFACE

As indicated in the On-Chip Registers section, the programmable functions of the AD7194 are controlled using a set of on-chip registers. Data is written to these registers via the serial interface of the part. Read access to the on-chip registers is also provided by this interface.

All communication with the part must start with a write to the communications register. After power-on or reset, the device expects a write to its communications register. The data written to this register determines whether the next operation is a read operation or a write operation, and it determines to which register this read or write operation occurs. Therefore, write access to any of the other registers on the part begins with a write operation to the communications register, followed by a write to the selected register. A read operation from any other register (except when continuous read mode is selected) starts with a write to the communications register, followed by a read operation from the selected register.

The serial interface of the AD7194 consists of four signals: \overline{CS} , DIN, SCLK, and DOUT/RDY. The DIN line is used to transfer data into the on-chip registers and DOUT/RDY is used for accessing data from the on-chip registers. SCLK is the serial clock input for the device, and all data transfers (either on DIN or DOUT/RDY) occur with respect to the SCLK signal.

The DOUT/RDY pin functions as a data ready signal also, the line going low when a new data-word is available in the output register. It is reset high when a read operation from the data register is complete. It also goes high prior to the updating of the data register to indicate when not to read from the device, to ensure that a data read is not attempted while the register is being updated. \overline{CS} is used to select a device. It can be used to decode the AD7194 in systems where several components are connected to the serial bus.

Figure 3 and Figure 4 show timing diagrams for interfacing to the AD7194 using \overline{CS} to decode the part. Figure 3 shows the timing for a read operation from the output shift register of the AD7194, and Figure 4 shows the timing for a write operation to the input shift register. It is possible to read the same word from the data register several times even though the DOUT/RDY line returns high after the first read operation. However, care must be taken to ensure that the read operations are completed before the next output update occurs. In continuous read mode, the data register can be read only once.

The serial interface can operate in 3-wire mode by tying \overline{CS} low. In this case, the SCLK, DIN, and DOUT/RDY lines are used to communicate with the AD7194. The end of the conversion can be monitored using the RDY bit or pin. This scheme is suitable for interfacing to microcontrollers. If \overline{CS} is required as a decoding signal, it can be generated from a port pin. For microcontroller interfaces, it is recommended that SCLK idle high between data transfers.

The AD7194 can be operated with \overline{CS} used as a frame synchronization signal. This scheme is useful for DSP interfaces. In this case, the first bit (MSB) is effectively clocked out by \overline{CS} because \overline{CS} normally occurs after the falling edge of SCLK in DSPs. The SCLK can continue to run between data transfers, provided the timing numbers are obeyed.

The serial interface can be reset by writing a series of 1s to the DIN input. If a Logic 1 is written to the AD7194 DIN line for at least 40 serial clock cycles, the serial interface is reset. This ensures that the interface can be reset to a known state if the interface is lost due to a software error or a glitch in the system. Reset returns the interface to the state in which it expects a write to the communications register. This operation resets the contents of all registers to their power-on values. Following a reset, the user should allow a period of 200 μ s before addressing the serial interface.

The AD7194 can be configured to continuously convert or to perform a single conversion (see Figure 24 through Figure 26).

Single Conversion Mode

In single conversion mode, the AD7194 is placed in power-down mode after conversions. When a single conversion is initiated by setting MD2 to 0, MD1 to 0, and MD0 to 1 in the mode register, the AD7194 powers up, performs a single conversion, and then returns to power-down mode. The on-chip oscillator requires 200 μ s, approximately, to power up.

DOUT/RDY goes low to indicate the completion of a conversion. When the data-word has been read from the data register,

DOUT/RDY goes high. If CS is low, DOUT/RDY remains high until another conversion is initiated and completed. The data register can be read several times, if required, even when DOUT/RDY has gone high.

If the DAT_STA bit in the mode register is set to 1, the contents of the status register are output along with the conversion each time that the data read is performed. The four LSBs of the status register indicate the channel to which the conversion corresponds.

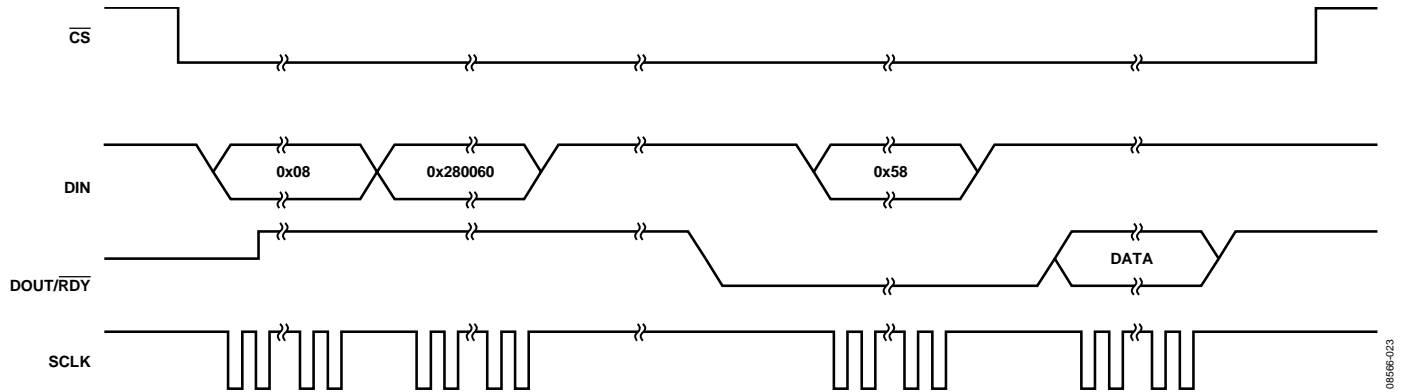

Figure 24. Single Conversion

08f96e-023

Continuous Conversion Mode

Continuous conversion is the default power-up mode. The AD7194 converts continuously, and the RDY bit in the status register goes low each time a conversion is complete. If CS is low, the DOUT/RDY line also goes low when a conversion is completed. To read a conversion, the user writes to the communications register, indicating that the next operation is a read of the data register. When the data-word has been read from the data register, DOUT/RDY goes high. The user can read this

register additional times, if required. However, the user must ensure that the data register is not being accessed at the completion of the next conversion or else the new conversion word is lost.

If the DAT_STA bit in the mode register is set to 1, the contents of the status register are output along with the conversion each time that the data read is performed. The status register indicates the channel to which the conversion corresponds.

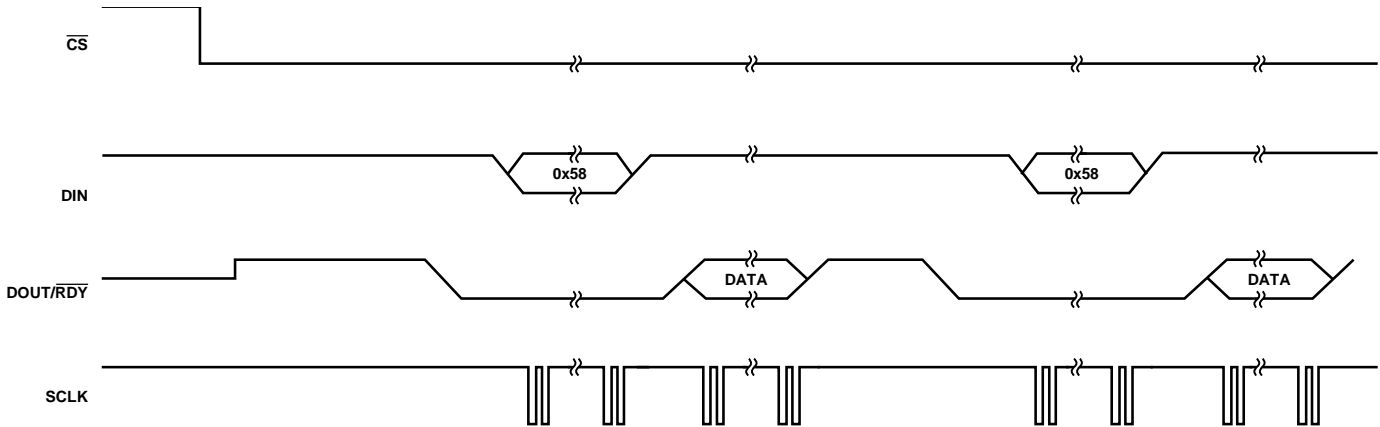

Figure 25. Continuous Conversion

08586-024

Continuous Read

Rather than write to the communications register each time a conversion is complete to access the data, the AD7194 can be configured so that the conversions are placed on the DOUT/RDY line automatically. By writing 01011100 to the communications register, the user need only apply the appropriate number of SCLK cycles to the ADC, and the conversion word is automatically placed on the DOUT/RDY line when a conversion is complete. The ADC should be configured for continuous conversion mode.

When DOUT/RDY goes low to indicate the end of a conversion, sufficient SCLK cycles must be applied to the ADC; the data conversion is then placed on the DOUT/RDY line. When the conversion is read, DOUT/RDY returns high until the next conversion is available. In this mode, the data can be read only once. The user must also ensure that the data-word is read

before the next conversion is complete. If the user has not read the conversion before the completion of the next conversion, or if insufficient serial clocks are applied to the AD7194 to read the word, the serial output register is reset when the next conversion is complete, and the new conversion is placed in the output serial register.

To exit the continuous read mode, Instruction 01011000 must be written to the communications register while the RDY pin is low. While in the continuous read mode, the ADC monitors activity on the DIN line so that it can receive the instruction to exit the continuous read mode. Additionally, a reset occurs if 40 consecutive 1s are seen on DIN. Therefore, DIN should be held low in continuous read mode until an instruction is to be written to the device.

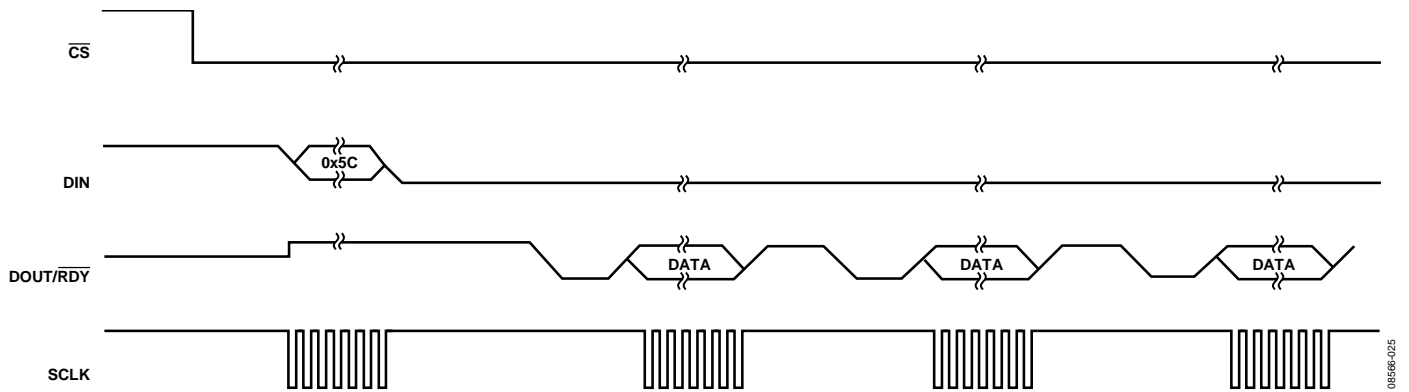

Figure 26. Continuous Read

08596-025

RESET

The circuitry and serial interface of the AD7194 can be reset by writing consecutive 1s to the device; 40 consecutive 1s are required to perform the reset. This resets the logic, the digital filter, and the analog modulator, whereas all on-chip registers are reset to their default values.

A reset is automatically performed on power-up. When a reset is initiated, the user must allow a period of 200 μ s before accessing any of the on-chip registers. A reset is useful if the serial interface loses synchronization due to noise on the SCLK line.

SYSTEM SYNCHRONIZATION

The $\overline{\text{SYNC}}$ input allows the user to reset the modulator and the digital filter without affecting any of the setup conditions on the part. This allows the user to start gathering samples of the analog input from a known point in time, that is, the rising edge of $\overline{\text{SYNC}}$. $\overline{\text{SYNC}}$ needs to be taken low for at least four master clock cycles to implement the synchronization function.

If multiple AD7194 devices are operated from a common master clock, they can be synchronized so that their data registers are updated simultaneously. A falling edge on the $\overline{\text{SYNC}}$ pin resets the digital filter and the analog modulator and places the AD7194 into a consistent, known state. While the $\overline{\text{SYNC}}$ pin is low, the AD7194 is maintained in this state. On the $\overline{\text{SYNC}}$ rising edge, the modulator and filter are taken out of this reset state and, on the next clock edge, the part starts to gather input samples again. In a system using multiple AD7194 devices, a common signal to their $\overline{\text{SYNC}}$ pins synchronizes their operation. This is normally done after each AD7194 has performed its own calibration or has calibration coefficients loaded into its calibration registers. The conversions from the AD7194s are then synchronized.

The part is taken out of reset on the master clock falling edge following the $\overline{\text{SYNC}}$ low to high transition. Therefore, when multiple devices are being synchronized, the $\overline{\text{SYNC}}$ pin should be taken high on the master clock rising edge to ensure that all devices begin sampling on the master clock falling edge. If the $\overline{\text{SYNC}}$ pin is not taken high in sufficient time, it is possible to have a difference of one master clock cycle between the devices; that is, the instant at which conversions are available differs from part to part by a maximum of one master clock cycle.

The $\overline{\text{SYNC}}$ pin can also be used as a start conversion command. In this mode, the rising edge of $\overline{\text{SYNC}}$ starts conversion, and the falling edge of $\overline{\text{RDY}}$ indicates when the conversion is complete. The settling time of the filter has to be allowed for each data register update. For example, if the ADC is configured to use the sinc⁴ filter, zero latency is disabled, and chop is disabled, the settling time equals $4/f_{\text{ADC}}$ where f_{ADC} is the output data rate when continuously converting on a single channel.

ENABLE PARITY

When the ENPAR bit in the mode register is set to 1, parity is enabled. The contents of the status register must be transmitted along with each 24-bit conversion when the parity function is enabled. To append the contents of the status register to each conversion read, the DAT_STA bit in the mode register should be set to 1. For each conversion read, the parity bit in the status register is programmed so that the overall number of 1s transmitted in the 24-bit data-word is even. Therefore, for example, if the 24-bit conversion contains 11 ones (binary format), the parity bit is set to 1 so that the total number of ones in the serial transmission is even. If the microprocessor receives an odd number of 1s, it knows that the data received has been corrupted.

The parity function does not ensure that all errors are detected. For example, two bits of corrupt data can result in the microprocessor receiving an even number of ones. Therefore, an error condition is not detected.

CLOCK

The AD7194 includes an internal 4.92 MHz clock on-chip. This internal clock has a tolerance of $\pm 4\%$. Either the internal clock or an external crystal/clock can be used as the clock source to the AD7194. The clock source is selected using the CLK1 and CLK0 bits in the mode register. When an external crystal is used, it must be connected across the MCLK1 and MCLK2 pins. The crystal manufacturer recommends the load capacitances required for the crystal. The MCLK1 and MCLK2 pins of the AD7194 have a capacitance of 15 pF, typically. If an external clock source is used, the clock source must be connected to the MCLK2 pin, and the MCLK1 pin can remain floating.

The internal clock can also be made available at the MCLK2 pin. This is useful when several ADCs are used in an application and the devices must be synchronized. The internal clock from one device can be used as the clock source for all ADCs in the system. Using a common clock, the devices can be synchronized by applying a common reset to all devices, or the $\overline{\text{SYNC}}$ pin can be pulsed.

TEMPERATURE SENSOR

Embedded in the AD7194 is a temperature sensor. This is selected using the TEMP bit in the configuration register. When the TEMP bit is set to 1, the temperature sensor is enabled. When the temperature sensor is selected and bipolar mode is selected, the device should return a code of 0x800000 when the temperature is 0 Kelvin, theoretically. A one-point calibration is needed to obtain the optimum performance from the sensor. Therefore, a conversion at 25°C should be recorded and the sensitivity calculated. The sensitivity is 2815 codes/°C, approximately. The equation for the temperature sensor is

$$\text{Temperature (K)} = (\text{Conversion} - 0x800000)/2815 \text{ K}$$

$$\text{Temperature (°C)} = \text{Temperature (K)} - 273$$

Following the one-point calibration, the internal temperature sensor has an accuracy of $\pm 2^{\circ}\text{C}$, typically.

LOGIC OUTPUTS

The AD7194 has four general-purpose digital outputs: P0, P1, P2, and P3. These are enabled using the GP32EN and GP10EN bits in the GPOCON register. The pins can be pulled high or low using the P0DAT to P3DAT bits in the GPOCON register; that is, the value at the pin is determined by the setting of the P0DAT to P3DAT bits. The logic levels for these pins are determined by AV_{DD} rather than by DV_{DD} . When the GPOCON register is read, Bit P0DAT to Bit P3DAT reflect the actual value at the pins; this is useful for short-circuit detection.

These pins can be used to drive external circuitry, for example, an external multiplexer. If an external multiplexer is used to increase the channel count, the multiplexer logic pins can be controlled via the AD7194 general-purpose output pins. The general-purpose output pins can be used to select the active multiplexer pin. Because the operation of the multiplexer is independent of the AD7194, the AD7194 modulator and filter should be reset using the SYNC pin or by a write to the mode or configuration register each time that the multiplexer channel is changed.

CALIBRATION

The AD7194 provides four calibration modes that can be programmed via the mode bits in the mode register. These modes are internal zero-scale calibration, internal full-scale calibration, system zero-scale calibration, and system full-scale calibration. A calibration can be performed at any time by setting the MD2 to MD0 bits in the mode register appropriately. A calibration should be performed when the gain is changed. After each conversion, the ADC conversion result is scaled using the ADC calibration registers before being written to the data register. The offset calibration coefficient is subtracted from the result prior to multiplication by the full-scale coefficient.

To start a calibration, write the relevant value to the MD2 to MD0 bits. The DOUT/RDY pin and the RDY bit in the status register go high when the calibration initiates. When the calibration is complete, the contents of the corresponding calibration registers are updated, the RDY bit in the status register is reset, the DOUT/RDY pin returns low (if CS is low), and the AD7194 reverts to idle mode.

During an internal zero-scale or full-scale calibration, the respective zero input and full-scale input are automatically connected internally to the ADC input pins. A system calibration, however, expects the system zero-scale and system full-scale voltages to be applied to the ADC pins before initiating the calibration mode. In this way, errors external to the ADC are removed.

From an operational point of view, treat a calibration like another ADC conversion. A zero-scale calibration, if required, must always be performed before a full-scale calibration. Set the system software to monitor the RDY bit in the status register or the DOUT/RDY pin to determine the end of calibration via a polling sequence or an interrupt-driven routine.

With chop disabled, both an internal zero-scale calibration and a system zero-scale calibration require a time equal to the settling time, t_{SETTLE} ($4/f_{ADC}$ for the sinc⁴ filter and $3/f_{ADC}$ for the sinc³ filter).

With chop enabled, an internal zero-scale calibration is not needed because the ADC itself minimizes the offset continuously. However, if an internal zero-scale calibration is performed, the settling time, t_{SETTLE} ($2/f_{ADC}$), is required to perform the calibration. Similarly, a system zero-scale calibration requires a time of t_{SETTLE} to complete.

To perform an internal full-scale calibration, a full-scale input voltage is automatically connected to the selected analog input for this calibration. For a gain of 1, the time required for an internal full-scale calibration is equal to t_{SETTLE} . For higher gains, the internal full-scale calibration requires a time of $2 \times t_{SETTLE}$. A full-scale calibration is recommended each time the gain of a channel is changed to minimize the full-scale error.

A system full-scale calibration requires a time of t_{SETTLE} . With chop disabled, the zero-scale calibration (internal or system zero-scale) should be performed before the system full-scale calibration is initiated.

An internal zero-scale calibration, system zero-scale calibration, and system full-scale calibration can be performed at any output data rate. An internal full-scale calibration can be performed at any output data rate for which the filter word, FS[9:0], is divisible by 16, FS[9:0] being the decimal equivalent of the 10-bit word written to Bit FS9 to Bit FS0 in the mode register. Therefore, internal full-scale calibrations can be performed at output data rates such as 10 Hz or 50 Hz when chop is disabled. Using these lower output data rates results in better calibration accuracy.

The offset error is, typically, $\pm 150 \mu\text{V}/\text{gain}$. If the gain is changed, it is advisable to perform a calibration. A zero-scale calibration (an internal zero-scale calibration or a system zero-scale calibration) reduces the offset error to the order of the noise.

The gain error of the AD7194 is factory calibrated at a gain of 1 with a 5 V power supply at ambient temperature. Following this calibration, the gain error is $\pm 0.001\%$, typically, at 5 V. Table 27 shows the typical uncalibrated gain error for the different gain settings.

Table 27. Typical Precalibration Gain Error vs. Gain

Gain	Precalibration Gain Error (%)
8	-0.11
16	-0.20
32	-0.23
64	-0.29
128	-0.4

An internal full-scale calibration reduces the gain error to $\pm 0.001\%$, typically, when the gain is equal to 1. For higher gains, the gain error post internal full-scale calibration is $\pm 0.003\%$, typically when $A_{V_{DD}}$ is equal to or higher than 4.75 V. When $A_{V_{DD}}$ is less than 4.75 V, the gain error post internal full-scale calibration is $\pm 0.005\%$, typically.

When $A_{V_{DD}}$ is less than 4.75 V, the CLK_DIV bit must be set when performing internal full-scale calibrations. This increases the calibration time by a factor of 2. The accuracy of the internal full-scale calibration is further increased if chop is enabled and a low output data rate is used while performing the calibration.

A system full-scale calibration reduces the gain error to the order of the noise irrespective of the analog power supply voltage.

The AD7194 gives the user access to the on-chip calibration registers, allowing the microprocessor to read the calibration coefficients of the device and also to write its own calibration coefficients from prestored values in the EEPROM. A read of the registers can be performed at any time. However, the ADC must be placed in power-down or idle mode when writing to the registers. The values in the calibration registers are 24 bits wide. The span and offset of the part can also be manipulated using the registers.

DIGITAL FILTER

The AD7194 offers a lot of flexibility in the digital filter. The device has five filter options. The device can be operated with a sinc³ or sinc⁴ filter, chop can be enabled or disabled, and zero latency can be enabled. Finally, an averaging block can be included after the sinc filter, which gives a fast settling mode. The option selected affects the output data rate, settling time, and 50 Hz/60 Hz rejection. The following sections describe each filter type, indicating the available output data rates for each filter option. The filter response along with the settling time and 50 Hz/60 Hz rejection is also discussed.

SINC⁴ FILTER (CHOP DISABLED)

When the AD7194 is powered up, the sinc⁴ filter is selected by default and chop is disabled. This filter gives excellent noise performance over the complete range of output data rates. It also gives the best 50 Hz/60 Hz rejection, but it has a long settling time.

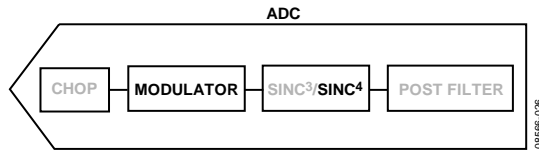

Figure 27. Sinc⁴ Filter (Chop Disabled)

Sinc⁴ Output Data Rate/Settling Time

The output data rate (the rate at which conversions are available on a single channel when the ADC is continuously converting) is equal to

$$f_{ADC} = f_{CLK} / (1024 \times FS[9:0])$$

where:

f_{ADC} is the output data rate.

f_{CLK} is the master clock (4.92 MHz nominal).

$FS[9:0]$ is the decimal equivalent of Bit FS9 to Bit FS0 in the mode register.

The output data rate can be programmed from 4.7 Hz to 4800 Hz; that is, $FS[9:0]$ can have a value from 1 to 1023.

The settling time for the sinc⁴ filter is equal to

$$t_{SETTLE} = 4 / f_{ADC}$$

When a channel change occurs, the modulator and filter are reset. The settling time is allowed to generate the first conversion after the channel change. Subsequent conversions on this channel occur at $1/f_{ADC}$.

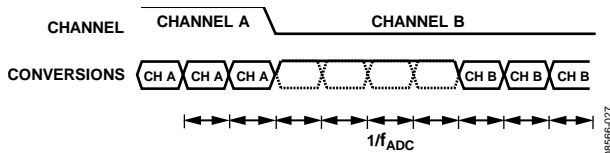

Figure 28. Sinc⁴ Channel Change

When conversions are performed on a single channel and a step change occurs, the ADC does not detect the change in analog input. Therefore, it continues to output conversions at the programmed output data rate. However, it is at least four conversions later before the output data accurately reflect the analog input. If the step change occurs while the ADC is processing a conversion, then the ADC takes five conversions after the step change to generate a fully settled result.

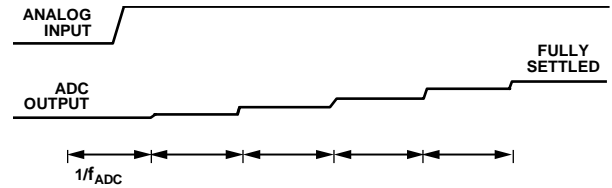

Figure 29. Asynchronous Step Change in Analog Input

The 3 dB frequency for the sinc⁴ filter is equal to

$$f_{3dB} = 0.23 \times f_{ADC}$$

Table 28 gives some examples of the relationship between the values in Bits $FS[9:0]$ and the corresponding output data rate and settling time.

Table 28. Examples of Output Data Rates and the Corresponding Settling Time

FS[9:0]	Output Data Rate (Hz)	Settling Time (ms)
480	10	400
96	50	80
80	60	66.6

Sinc⁴ Zero Latency

Zero latency is enabled by setting the single bit (Bit 11) in the mode register to 1. With zero latency, the complete settling time is allowed for each conversion. Therefore, the conversion time when converting on a single channel or when converting on several channels is constant. The user does not need to consider the effects of channel changes on the output data rate.

The output data rate equals

$$f_{ADC} = 1 / t_{SETTLE} = f_{CLK} / (4 \times 1024 \times FS[9:0])$$

where:

f_{ADC} is the output data rate.

f_{CLK} is the master clock (4.92 MHz nominal).

$FS[9:0]$ is the decimal equivalent of Bit FS9 to Bit FS0 in the mode register.

When the analog input is constant or a channel change occurs, valid conversions are available at a constant output data rate. When conversions are being performed on a single channel and a step change occurs on the analog input, the ADC continues to output fully settled conversions if the step change is synchronized with the conversion process. If the step change is asynchronous, one conversion is output from the ADC, which is not completely settled (see Figure 30).

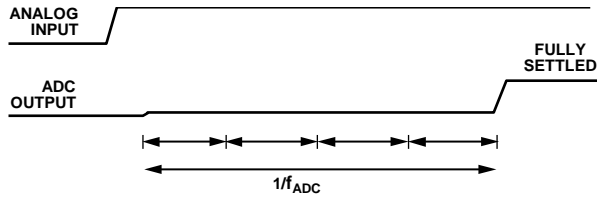

Figure 30. Sinc⁴ Zero Latency Operation

Table 29 shows examples of output data rate and the corresponding FS values.

Table 29. Examples of Output Data Rates and the Corresponding Settling Time (Zero Latency)

FS[9:0]	Output Data Rate (Hz)	Settling Time (ms)
480	2.5	400
96	12.5	80
80	15	66.6

Sinc⁴ 50 Hz/60 Hz Rejection

Figure 31 shows the frequency response of the sinc⁴ filter when FS[9:0] is set to 96 and the master clock is 4.92 MHz. With zero latency disabled, the output data rate is equal to 50 Hz. With zero latency enabled, the output data rate is 12.5 Hz. The sinc⁴ filter provides 50 Hz (±1 Hz) rejection in excess of 120 dB minimum, assuming a stable master clock.

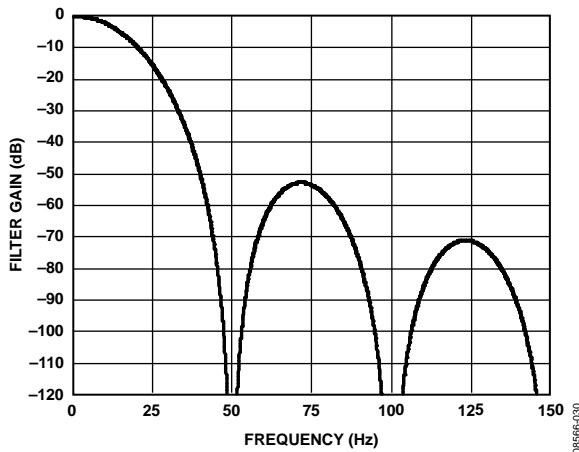

Figure 31. Sinc⁴ Filter Response (FS[9:0] = 96)

Figure 32 shows the frequency response when FS[9:0] is programmed to 80 and the master clock is equal to 4.92 MHz. The output data rate is 60 Hz when zero latency is disabled and 15 Hz when zero latency is enabled. The sinc⁴ filter provides 60 Hz (±1 Hz) rejection of 120 dB minimum, assuming a stable master clock.

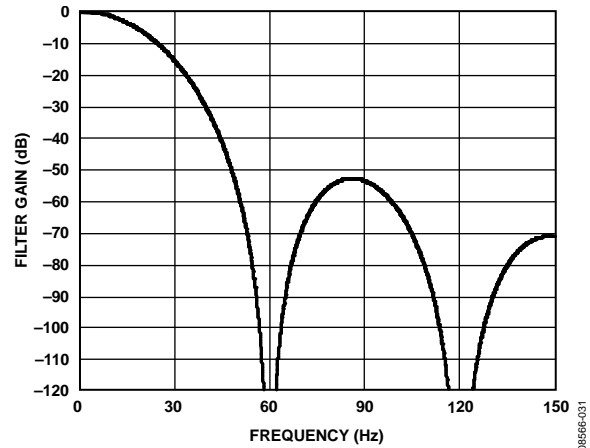

Figure 32. Sinc⁴ Filter Response (FS[9:0] = 80)

Simultaneous 50 Hz and 60 Hz rejection is obtained when FS[9:0] is programmed to 480 and the master clock equals 4.92 MHz. The output data rate is 10 Hz when zero latency is disabled and 2.5 Hz when zero latency is enabled. The sinc⁴ filter provides 50 Hz (±1 Hz) and 60 Hz (±1 Hz) rejection of 120 dB minimum, assuming a stable master clock.

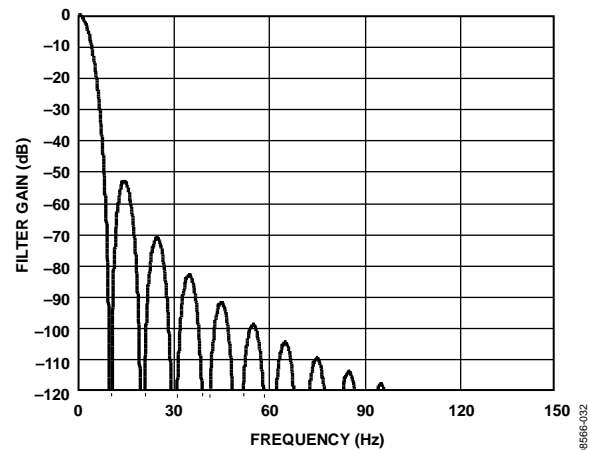

Figure 33. Sinc⁴ Filter Response (FS[9:0] = 480)

Simultaneous 50 Hz/60 Hz rejection can also be achieved using the REJ60 bit in the mode register. When FS[9:0] is set to 96 and REJ60 is set to 1, notches are placed at 50 Hz and 60 Hz.

The output data rate is 50 Hz when zero latency is disabled and 12.5 Hz when zero latency is enabled. Figure 34 shows the frequency response of the sinc⁴ filter. The filter provides 50 Hz ±1 Hz and 60 Hz ±1 Hz rejection of 82 dB minimum, assuming a stable 4.92 MHz master clock.

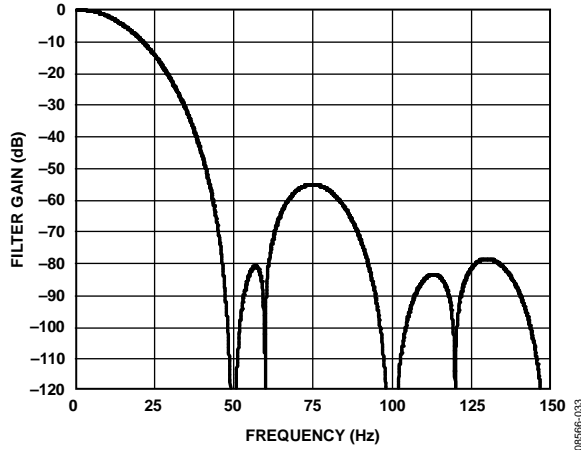

Figure 34. Sinc⁴ Filter Response (FS[9:0] = 96, REJ60 = 1)

SINC³ FILTER (CHOP DISABLED)

A sinc³ filter can be used instead of the sinc⁴ filter. The filter is selected using the SINC3 bit in the mode register. The sinc³ filter is selected when the SINC3 bit is set to 1.

This filter has good noise performance when operating with output data rates up to 1 kHz. It has moderate settling time and moderate 50 Hz/60 Hz (±1 Hz) rejection.

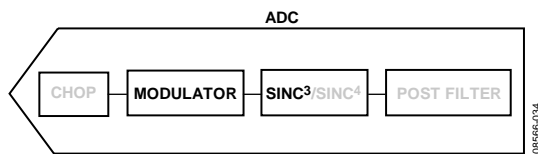

Figure 35. Sinc³ Filter (Chop Disabled)

Sinc³ Output Data Rate and Settling Time

The output data rate (the rate at which conversions are available on a single channel when the ADC is continuously converting) is equal to

$$f_{ADC} = f_{CLK} / (1024 \times FS[9:0])$$

where:

f_{ADC} is the output data rate.

f_{CLK} is the master clock (4.92 MHz nominal).

FS[9:0] is the decimal equivalent of Bit FS9 to Bit FS0 in the mode register.

The output data rate can be programmed from 4.7 Hz to 4800 Hz; that is, FS[9:0] can have a value from 1 to 1023.

The settling time is equal to

$$t_{SETTLE} = 3/f_{ADC}$$

The 3 dB frequency is equal to

$$f_{3dB} = 0.272 \times f_{ADC}$$

Table 30 gives some examples of FS settings and the corresponding output data rates and settling times.

Table 30. Examples of Output Data Rates and the Corresponding Settling Time

FS[9:0]	Output Data Rate (Hz)	Settling Time (ms)
480	10	300
96	50	60
80	60	50

When a channel change occurs, the modulator and filter reset. The complete settling time is allowed to generate the first conversion after the channel change (see Figure 36). Subsequent conversions on this channel are available at $1/f_{ADC}$.

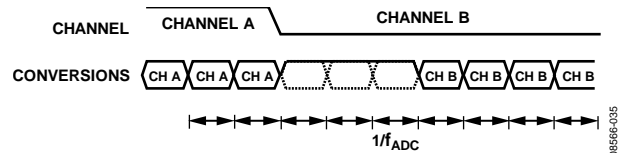

Figure 36. Sinc³ Channel Change

When conversions are performed on a single channel and a step change occurs, the ADC does not detect the change in analog input. Therefore, it continues to output conversions at the programmed output data rate. However, it is at least three conversions later before the output data accurately reflects the analog input. If the step change occurs while the ADC is processing a conversion, the ADC takes four conversions after the step change to generate a fully settled result.

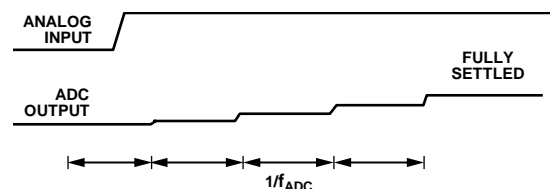

Figure 37. Asynchronous Step Change in Analog Input

Sinc³ Zero Latency

Zero latency is enabled by setting the single bit (Bit 11) in the mode register to 1. With zero latency, the complete settling time is allowed for each conversion. Therefore, the conversion time when converting on a single channel or when converting on several channels is constant. The user does not need to consider the effects of channel changes on the output data rate.

The output data rate equals

$$f_{ADC} = 1/t_{SETTLE} = f_{CLK}/(3 \times 1024 \times FS[9:0])$$

where:

f_{ADC} is the output data rate.

f_{CLK} is the master clock (4.92 MHz nominal).

$FS[9:0]$ is the decimal equivalent of Bit FS9 to Bit FS0 in the mode register.

When the analog input is constant or a channel change occurs, valid conversions are available at a constant output data rate. When conversions are being performed on a single channel and a step change occurs on the analog input, the ADC continues to output fully settled conversions if the step change is synchronized with the conversion process. If the step change is asynchronous, one conversion is output from the ADC that is not completely settled (see Figure 38).

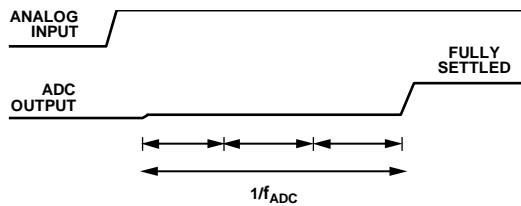

Figure 38. Sinc³ Zero Latency Operation

Table 31 provides examples of output data rates and the corresponding FS values.

Table 31. Examples of Output Data Rates and the Corresponding Settling Time (Zero Latency)

FS[9:0]	Output Data Rate (Hz)	Settling Time (ms)
480	3.3	300
96	16.7	60
80	20	50

Sinc³ 50 Hz/60 Hz Rejection

Figure 39 show the frequency response of the sinc³ filter when FS[9:0] is set to 96 and the master clock equals 4.92 MHz. The output data rate is equal to 50 Hz when zero latency is disabled and 16.7 Hz when zero latency is enabled. The sinc³ filter gives 50 Hz ± 1 Hz rejection of 95 dB minimum for a stable master clock.

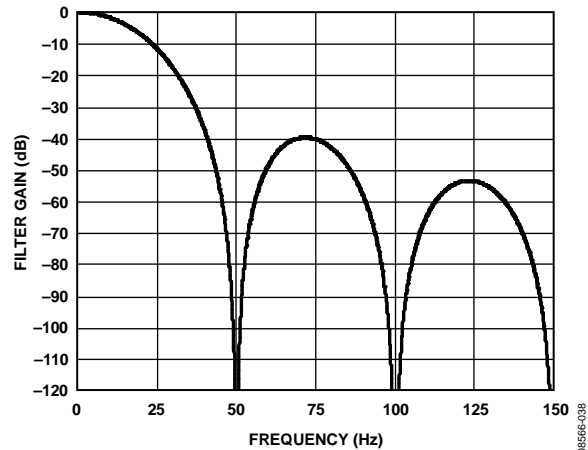

Figure 39. Sinc³ Filter Response (FS[9:0] = 96)

When FS[9:0] is set to 80 and the master clock equals 4.92 MHz, 60 Hz rejection is achieved (see Figure 40). The output data rate is equal to 60 Hz when zero latency is disabled and 20 Hz when zero latency is enabled. The sinc³ filter has rejection of 95 dB minimum at 60 Hz ± 1 Hz, assuming a stable master clock.

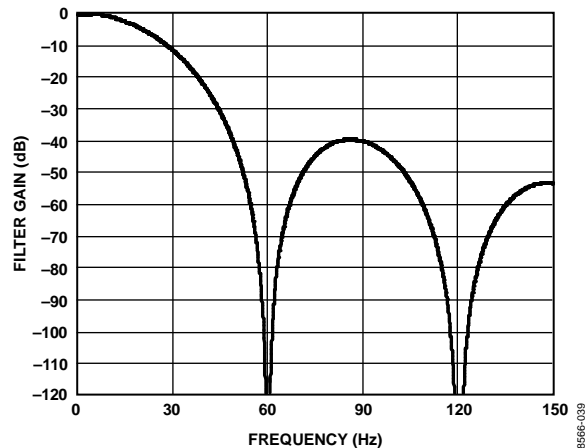

Figure 40. Sinc³ Filter Response (FS[9:0] = 80)

Simultaneous 50 Hz and 60 Hz rejection is obtained when FS[9:0] is set to 480 (master clock = 4.92 MHz), as shown in Figure 41. The output data rate is 10 Hz when zero latency is disabled and 3.3 Hz when zero latency is enabled. The sinc³ filter has rejection of 100 dB minimum at 50 Hz ± 1 Hz and 60 Hz ± 1 Hz.

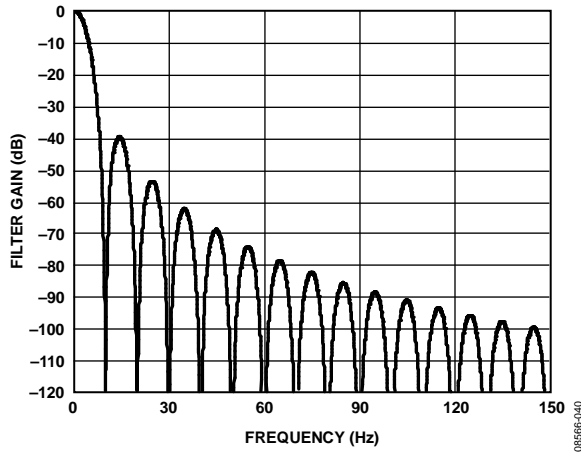

Figure 41. Sinc³ Filter Response (FS[9:0] = 480)

Simultaneous 50 Hz/60 Hz rejection is also achieved using the REJ60 bit in the mode register. When FS[9:0] is programmed to 96 and the REJ60 bit is set to 1, notches are placed at both 50 Hz and 60 Hz for a stable 4.92 MHz master clock. Figure 42 shows the frequency response of the sinc³ filter with this configuration. Assuming a stable clock, the rejection at 50 Hz/60 Hz (±1 Hz) is in excess of 67 dB minimum.

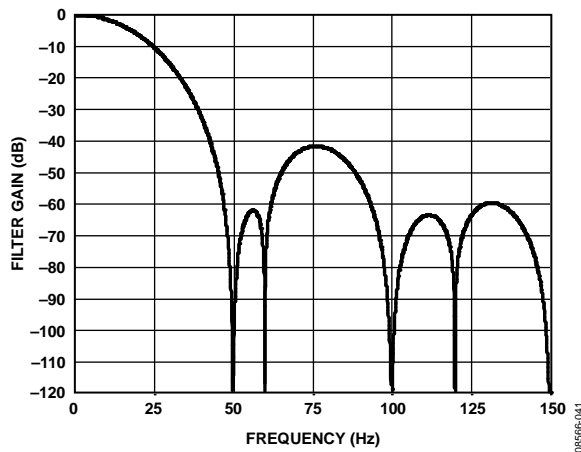

Figure 42. Sinc³ Filter Response (FS[9:0] = 96, REJ60 = 1)

CHOP ENABLED (SINC⁴ FILTER)

With chop enabled, the ADC offset and offset drift are minimized. The analog input pins are continuously swapped. With the analog input pins connected in one direction, the settling time of the sinc filter is allowed and a conversion is recorded. The analog input pins are then inverted, and another settled conversion is obtained. Subsequent conversions are averaged to minimize the offset. This continuous swapping of the analog input pins and the averaging of subsequent conversions means that the offset drift is also minimized. With chop enabled, the resolution increases by 0.5 bits.

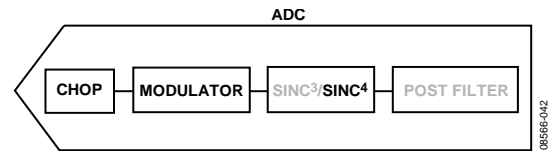

Figure 43. Chop Enabled

Output Data Rate and Settling Time (Sinc⁴ Chop Enabled)

For the sinc⁴ filter, the output data rate is equal to

$$f_{ADC} = f_{CLK} / (4 \times 1024 \times FS[9:0])$$

where:

f_{ADC} is the output data rate.

f_{CLK} is the master clock (4.92 MHz nominal).

FS[9:0] is the decimal equivalent of Bit FS9 to Bit FS0 in the mode register.

The value of FS[9:0] can be varied from 1 to 1023. This results in an output data rate of 1.17 Hz to 1200 Hz. The settling time is equal to

$$t_{SETTLE} = 2 / f_{ADC}$$

Table 32 gives some examples of FS[9:0] values and the corresponding output data rates and settling times.

Table 32. Examples of Output Data Rates and the Corresponding Settling Time

FS[9:0]	Output Data Rate (Hz)	Settling Time (ms)
96	12.5	160
80	15	133

When a channel change occurs, the modulator and filter reset. The complete settling time is required to generate the first conversion after the channel change. Subsequent conversions on this channel occur at $1/f_{ADC}$.

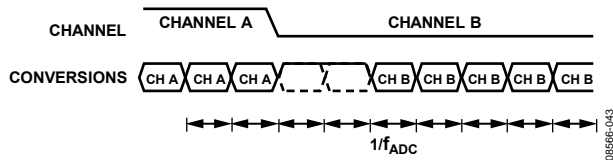

Figure 44. Channel Change ($Sinc^4$ Chop Enabled)

When conversions are performed on a single channel and a step change occurs, the ADC does not detect the change in analog input; therefore, it continues to output conversions at the programmed output data rate. However, it is at least two conversions later before the output data accurately reflects the analog input. If the step change occurs while the ADC is processing a conversion, the ADC takes three conversions after the step change to generate a fully settled result.

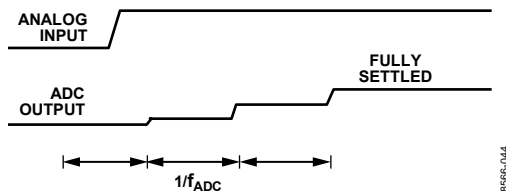

Figure 45. Asynchronous Step Change in Analog Input ($Sinc^4$ Chop Enabled)

The cutoff frequency f_{3dB} is equal to

$$f_{3dB} = 0.24 \times f_{ADC}$$

50 Hz/60 Hz Rejection ($Sinc^4$ Chop Enabled)

When FS[9:0] is set to 96 and chopping is enabled, the output data rate is equal to 12.5 Hz for a 4.92 MHz master clock. The filter response shown in Figure 46 is obtained. The chopping introduces notches at odd integer multiples of $f_{ADC}/2$. The notches due to the sinc filter in addition to the notches introduced by the chopping mean that simultaneous 50 Hz and 60 Hz rejection is achieved for an output data rate of 12.5 Hz. The rejection at 50 Hz/60 Hz ± 1 Hz is typically 63 dB, assuming a stable master clock.

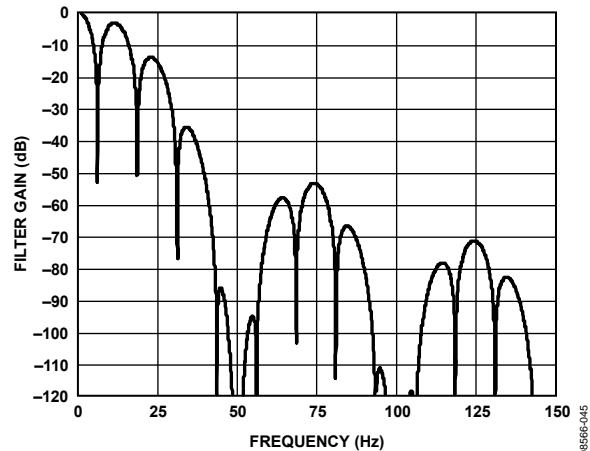

Figure 46. $Sinc^4$ Filter Response ($FS[9:0] = 96$, Chop Enabled)

The 50 Hz/60 Hz rejection can be improved by setting the REJ60 bit in the mode register to 1. With FS[9:0] set to 96 and REJ60 set to 1, the filter response shown in Figure 47 is achieved. The output data rate is unchanged but the 50 Hz/60 Hz (± 1 Hz) rejection is increased to 83 dB typically.

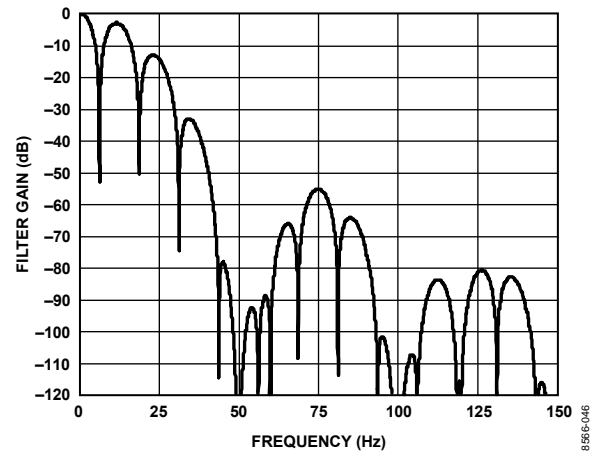

Figure 47. $Sinc^4$ Filter Response ($FS[9:0] = 96$, Chop Enabled, $REJ60 = 1$)

CHOP ENABLED (SINC³ FILTER)

With chop enabled, the ADC offset and offset drift are minimized. The analog input pins are continuously swapped. With the analog input pins connected in one direction, the settling time of the sinc filter is allowed and a conversion is recorded. The analog input pins invert and another settled conversion is obtained. Subsequent conversions are averaged to minimize the offset. This continuous swapping of the analog input pins and the averaging of subsequent conversions means that the offset drift is also minimized. With chop enabled, the resolution increases by 0.5 bits. Using the sinc³ filter with chop enabled is suitable for output data rates up to 320 Hz.

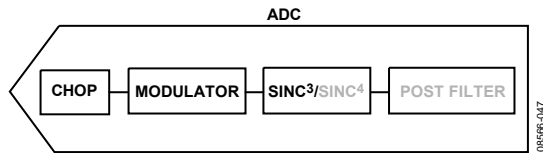

Figure 48. Chop Enabled (Sinc³ Chop Enabled)

Output Data Rate and Settling Time (Sinc³ Chop Enabled)

For the sinc³ filter, the output data rate is equal to

$$f_{ADC} = f_{CLK} / (3 \times 1024 \times FS[9:0])$$

where:

f_{ADC} is the output data rate.

f_{CLK} is the master clock (4.92 MHz nominal).

$FS[9:0]$ is the decimal equivalent of Bit FS9 to Bit FS0 in the mode register.

The value of $FS[9:0]$ can be varied from 1 to 1023. This results in an output data rate of 1.56 Hz to 1600 Hz. The settling time is equal to

$$t_{SETTLE} = 2/f_{ADC}$$

Table 33. Examples of Output Data Rates and the Corresponding Settling Time (Chop Enabled, Sinc³ Filter)

FS[9:0]	Output Data Rate (Hz)	Settling Time (ms)
96	16.7	120
80	20	100

When a channel change occurs, the modulator and filter are reset. The complete settling time is required to generate the first conversion after the channel change. Subsequent conversions on this channel occur at $1/f_{ADC}$.

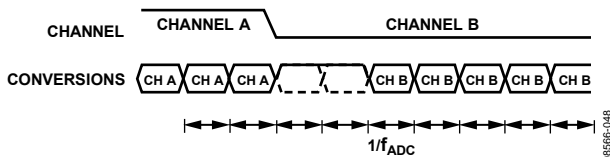

Figure 49. Channel Change (Sinc³ Chop Enable)

If conversions are performed on a single channel and a step change occurs, the ADC does not detect the change in analog input; therefore, it continues to output conversions at the programmed output data rate. However, it is at least two conversions later before the output data accurately reflects the analog input. If the step change occurs while the ADC is processing a conversion, then the ADC takes three conversions after the step change to generate a fully settled result.

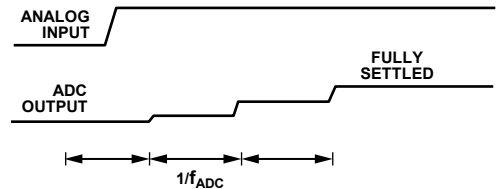

Figure 50. Asynchronous Step Change in Analog Input (Sinc³ Chop Enabled)

The cutoff frequency f_{3dB} is equal to

$$f_{3dB} = 0.24 \times f_{ADC}$$

50 Hz/60 Hz Rejection (Sinc³ Chop Enabled)

When $FS[9:0]$ is set to 96 and chopping is enabled, the filter response shown in Figure 51 is obtained. The output data rate is equal to 16.7 Hz for a 4.92 MHz master clock. The chopping introduces notches at odd integer multiples of $f_{ADC}/2$. The notches due to the sinc filter in addition to the notches introduced by the chopping means that simultaneous 50 Hz and 60 Hz rejection is achieved for an output data rate of 16.7 Hz. The rejection at 50 Hz/60 Hz ± 1 Hz is typically 53 dB, assuming a stable master clock.

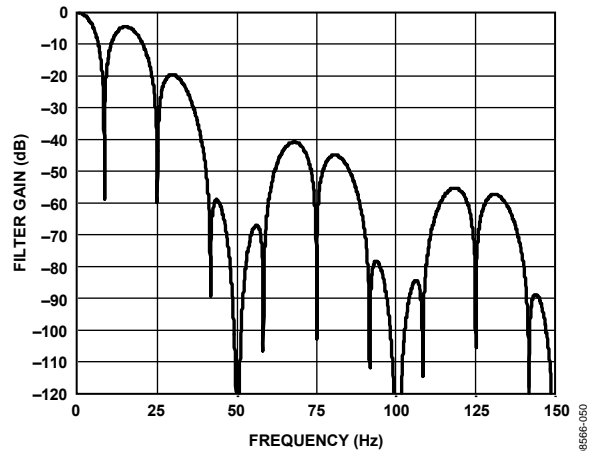

Figure 51. Sinc³ Filter Response ($FS[9:0] = 96$, Chop Enabled)

The 50 Hz/60 Hz rejection can be improved by setting the REJ60 bit in the mode register to 1. With FS[9:0] set to 96 and REJ60 set to 1, the filter response shown in Figure 52 is achieved. The output data rate is unchanged but the 50 Hz/60 Hz ± 1 Hz rejection improves to 73 dB typically.

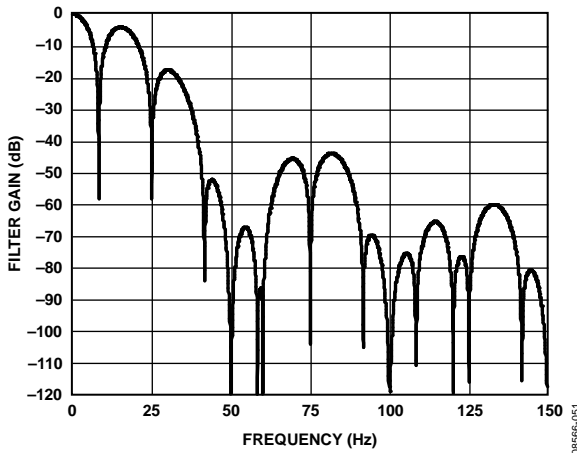

Figure 52. Sinc³ Filter Response (FS[9:0] = 96, Chop Enabled, REJ60 = 1)

FAST SETTLING MODE (SINC⁴ FILTER)

In fast settling mode, the settling time is close to the inverse of the first filter notch; therefore, the user can achieve 50 Hz and/or 60 Hz rejection at an output data rate close to 1/50 Hz or 1/60 Hz. The settling time is equal to 1/output data rate. Therefore, the conversion time is constant when converting on a single channel or when converting on several channels. There is no added latency when switching channels.

Enable the fast settling mode using Bit AVG1 and Bit AVG0 in the mode register. In fast settling mode, a postfilter is included after the sinc⁴ filter. The postfilter averages by 2, 8, or 16, depending on the settings of the AVG1 and AVG0 bits.

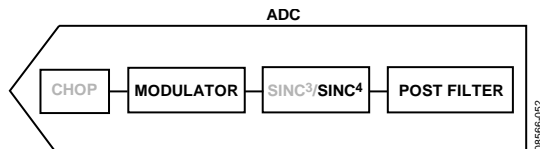

Figure 53. Fast Settling Mode, Sinc⁴ Filter

Output Data Rate and Settling Time, Sinc⁴ Filter

With chop disabled, the output data rate is

$$f_{ADC} = f_{CLK} / ((4 + Avg - 1) \times 1024 \times FS[9:0]) \tag{1}$$

where:

f_{ADC} is the output data rate.

f_{CLK} is the master clock (4.92 MHz nominal).

Avg is the average.

FS[9:0] is the decimal equivalent of Bit FS9 to Bit FS0 in the mode register.

If AVG1 = AVG0 = 0, the fast settling mode is not enabled. In this case, Equation 1 is not relevant.

The settling time is equal to

$$t_{SETTLE} = 1/f_{ADC}$$

Table 34 lists sample FS words and the corresponding output data rates and settling times.

Table 34. Examples of Output Data Rates and the Corresponding Settling Time (Fast Settling Mode, Sinc⁴)

FS[9:0]	Average	Output Data Rate (Hz)	Settling Time (ms)
96	16	2.63	380
30	16	8.4	118.75
6	16	42.1	23.75
5	16	50.53	19.79

When the analog input channel is changed, there is no additional delay in generating valid conversions—the device functions as a zero latency ADC.

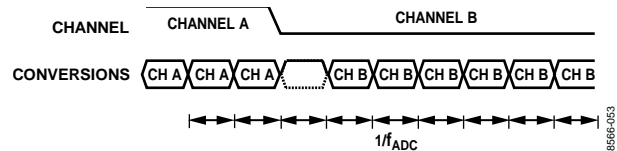

Figure 54. Fast Settling, Sinc⁴ Filter

When the device is converting on a single channel and a step change occurs on the analog input, the ADC does not detect the change and continues to output conversions. If the step change is synchronized with the conversion, only fully settled results are output from the ADC. However, if the step change is asynchronous to the conversion process, there is one intermediate result, which is not completely settled (see Figure 55).

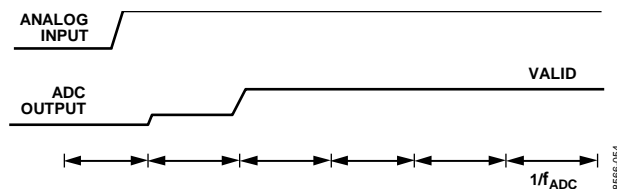

Figure 55. Step Change on Analog Input, Sinc⁴ Filter

The output data rate is the same for chop enabled and chop disabled in fast settling mode. However, when chop is enabled, the settling time equals

$$t_{SETTLE} = 2/f_{ADC}$$

Therefore, if chop is enabled, the sinc⁴ filter is selected, FS[9:0] is set to 6, and averaging by 16 is enabled. The output data rate is equal to 42.1 Hz when the master clock equals 4.92 MHz. Therefore, the conversion time equals 1/42.10 Hz or 23.75 ms and the settling time is equal to 47.5 ms.

50 Hz/60 Hz Rejection, Sinc⁴ Filter

Figure 56 shows the frequency response when FS[9:0] is set to 6 and the postfilter averages by 16. This gives an output data rate

of 42.10 Hz when the master clock equals 4.92 MHz. The sinc filter places the first notch at

$$f_{NOTCH} = f_{CLK} / (1024 \times FS[9:0])$$

The postfiltering places notches at f_{NOTCH}/Avg (Avg is the amount of averaging) and multiples of this frequency; therefore, when FS[9:0] is set to 6 and the postfilter averaging is 16, a notch is placed at 800 Hz due to the sinc filter and notches are placed at 50 Hz and multiples of 50 Hz due to the postfilter. The notch at 50 Hz is a first-order notch; therefore, the notch is not wide. This means that the rejection at 50 Hz exactly is good, assuming a stable 4.92 MHz master clock. However, in a band of 50 Hz \pm 1 Hz, the rejection degrades significantly. The rejection at 50 Hz \pm 0.5 Hz is 40 dB minimum, assuming a stable clock; therefore, a good master clock source is recommended when using fast settling mode.

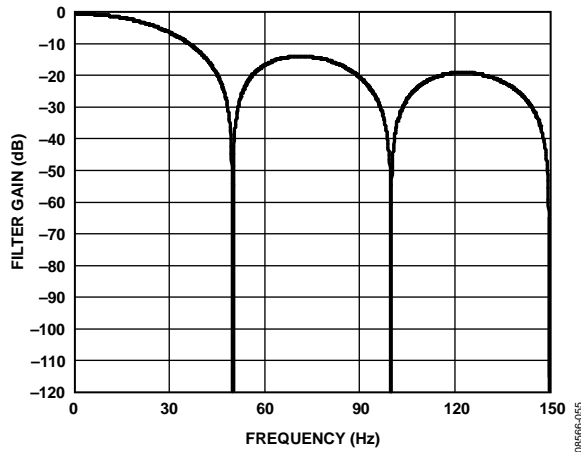

Figure 56. Filter Response for Average + Decimate Filter (Sinc⁴ Filter, FS[9:0] = 6, Average by 16)

Figure 57 shows the filter response when FS[9:0] is set to 5 and the postfilter averages by 16. In this case, the output data rate is equal to 50.53 Hz (4.92 MHz master clock) while the first filter notch is placed at 60 Hz. The rejection at 60 Hz \pm 0.5 Hz is equal to 40 dB minimum.

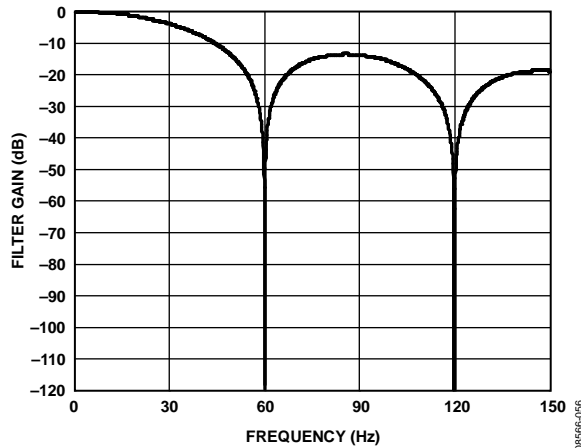

Figure 57. Filter Response for Average + Decimate Filter (Sinc⁴ Filter, FS[9:0] = 5, Average by 16)

Simultaneous 50 Hz/60 Hz rejection is achieved when FS[9:0] is set to 30 and the postfilter averages by 16. The output data rate is equal to 8.4 Hz whereas the rejection at 50 Hz \pm 0.5 Hz and 60 Hz \pm 0.5 Hz is 44 dB typically.

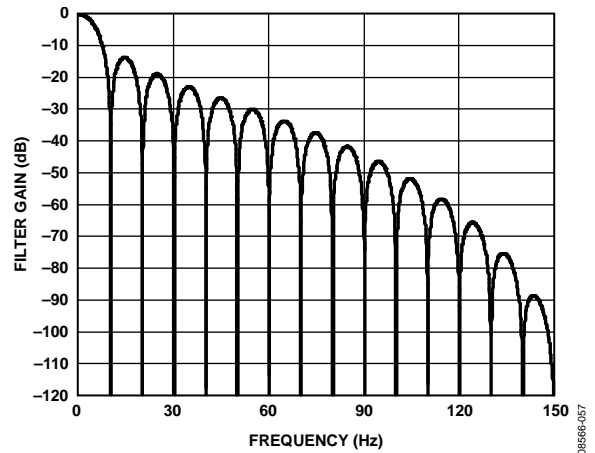

Figure 58. Filter Response for Average + Decimate Filter (Sinc⁴ Filter, FS[9:0] = 30, Average by 16)

Simultaneous 50 Hz and 60 Hz rejection is also achieved by using an FS word of 96 and averaging by 16; this places a notch at 50 Hz. Setting the REJ60 bit to 1 places a notch at 60 Hz (see Figure 59). The output data rate is reduced to 2.63 Hz with this configuration but the rejection is improved to 100 dB typically at 50 Hz \pm 1 Hz and 60 Hz \pm 1 Hz.

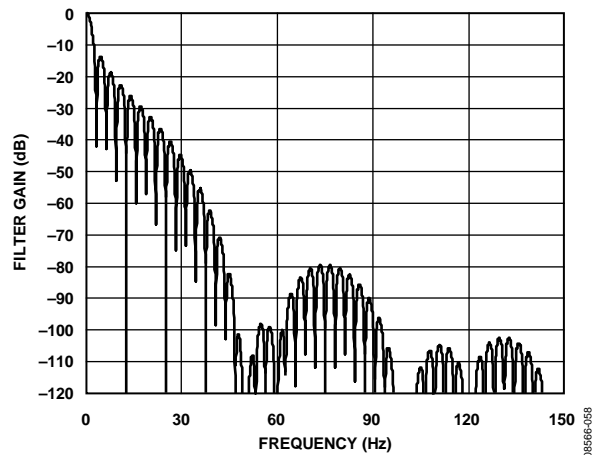

Figure 59. Filter Response for Average + Decimate Filter (Sinc⁴ Filter, FS[9:0] = 96, Average by 16)

FAST SETTling MODE (SINC³ FILTER)

In fast settling mode, the settling time is close to the inverse of the first filter notch. Therefore, the user can achieve 50 Hz and/or 60 Hz rejection at an output data rate close to 1/50 Hz or 1/60 Hz. The settling time is equal to 1/output data rate. Therefore, the conversion time is constant when converting on a single channel or when converting on several channels. There is no added latency when switching channels.

The fast settling mode is enabled using Bit AVG1 and Bit AVG0 in the mode register. A postfilter is included after the sinc⁴ filter. The postfilter averages by 2, 8, or 16, depending on the settings of the AVG1 and AVG0 bits.

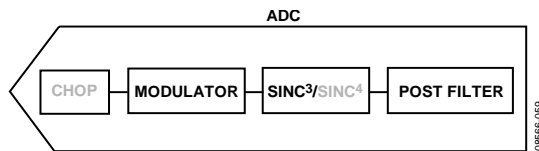

Figure 60. Fast Settling Mode, Sinc³ Filter

Output Data Rate and Settling Time, Sinc³ Filter

With chop disabled, the output data rate is

$$f_{ADC} = f_{CLK} / ((3 + Avg - 1) \times 1024 \times FS[9:0])$$

f_{ADC} is the output data rate.

f_{CLK} is master clock (4.92 MHz nominal).

Avg is the average.

$FS[9:0]$ is the decimal equivalent of Bit FS9 to Bit FS0 in the mode register.

If $AVG1 = AVG0 = 0$, the fast settling mode is not enabled. In this case, the preceding equation is not relevant.

The settling time is equal to

$$t_{SETTLE} = 1/f_{ADC}$$

Table 35 lists some sample FS words and the corresponding output data rates and settling times.

Table 35. Examples of Output Data Rates and the Corresponding Settling Time (Fast Settling Mode, Sinc³)

FS[9:0]	Average	Output Data Rate (Hz)	Settling Time (ms)
96	16	2.78 Hz	360 ms
30	16	8.9 Hz	112.5 ms
6	16	44.44 Hz	22.5 ms
5	16	53.3 Hz	18.75 ms

If the analog input channel is changed, there is no additional delay in generating valid conversions and the device functions as a zero latency ADC.

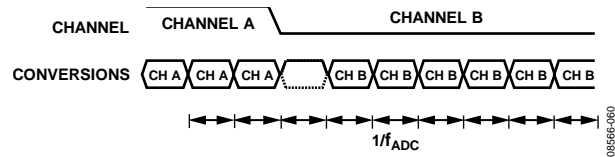

Figure 61. Fast Settling, Sinc³ Filter

When the device is converting on a single channel and a step change occurs on the analog input, the ADC does not detect the change and continues to output conversions. When the step change is synchronized with the conversion, only fully settled results are output from the ADC. However, if the step change is asynchronous to the conversion process, one intermediate result is not completely settled (see Figure 62).

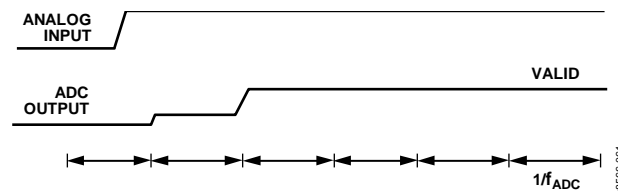

Figure 62. Step Change on Analog Input, Sinc³ Filter

50 Hz/60 Hz Rejection, Sinc³ Filter

Figure 63 shows the frequency response when $FS[9:0]$ is set to 6 and the postfilter averages by 16. This gives an output data rate of 44.44 Hz when the master clock is 4.92 MHz. The sinc filter places the first notch at

$$f_{NOTCH} = f_{CLK} / (1024 \times FS[9:0])$$

The postfiltering places notches at f_{NOTCH}/Avg (Avg is the amount of averaging) and multiples of this frequency. Therefore, when $FS[9:0]$ is set to 6 and the postfilter averaging is 16, a notch is placed at 800 Hz due to the sinc filter and notches are placed at 50 Hz and multiples of 50 Hz due to the postfilter.

The notch at 50 Hz is a first-order notch. Therefore, the notch is not wide. This means that the rejection at 50 Hz exactly is good, assuming a stable 4.92 MHz master clock. However, in a band of $50 \text{ Hz} \pm 1 \text{ Hz}$, the rejection degrades significantly. The rejection at $50 \text{ Hz} \pm 0.5 \text{ Hz}$ is 40 dB minimum, assuming a stable clock; therefore, a good master clock source is recommended when using fast settling mode.

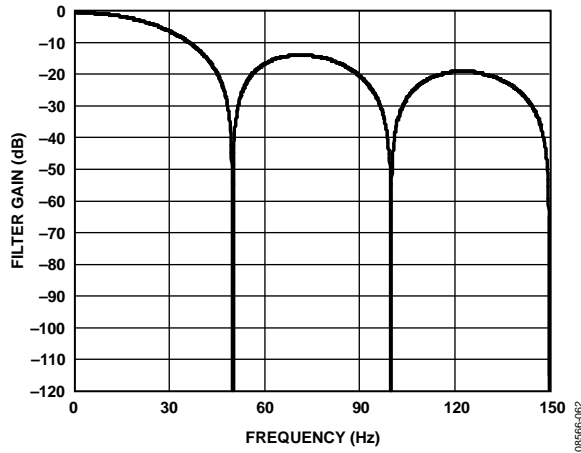

Figure 63. Filter Response for Average + Decimate Filter (Sinc³ Filter, FS[9:0] = 6, Average by 16)

Figure 64 shows the filter response when FS[9:0] is set to 5 and the post filter averages by 16. In this case, the output data rate is equal to 53.33 Hz when the first filter notch is placed at 60 Hz. The rejection at 60 Hz ± 0.5 Hz is equal to 40 dB minimum.

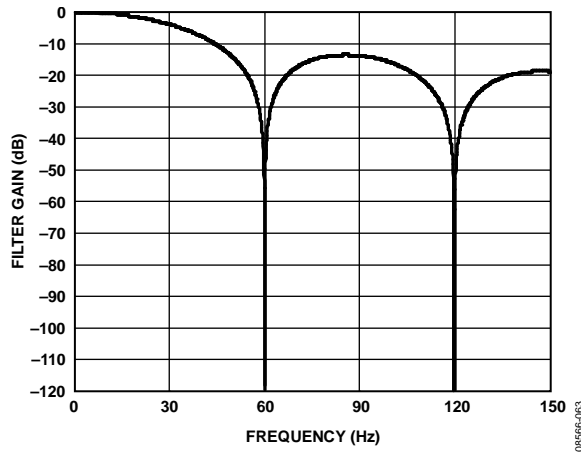

Figure 64. Filter Response for Average + Decimate Filter (Sinc³ Filter, FS[9:0] = 5, Average by 16)

Simultaneous 50 Hz/60 Hz rejection is achieved when FS[9:0] is set to 30 and the postfilter averages by 16. The output data rate is equal to 8.9 Hz, whereas the rejection at 50 Hz ± 0.5 Hz and 60 Hz ± 0.5 Hz is 42 dB typically.

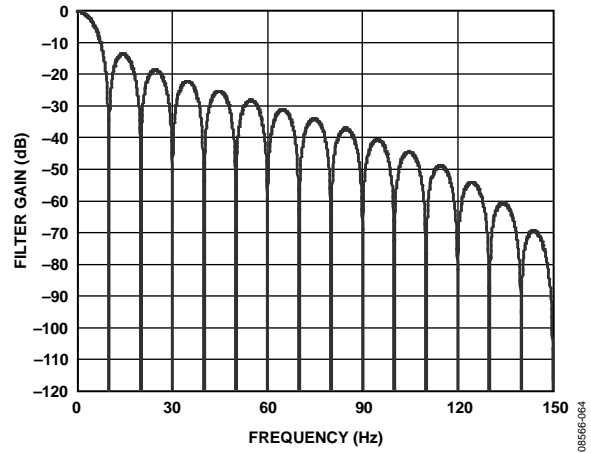

Figure 65. Filter Response for Average + Decimate Filter (Sinc³ Filter, FS[9:0] = 30, Average by 16)

Simultaneous 50 Hz and 60 Hz rejection is also achieved by using an FS word of 96 and averaging by 16, which places a notch at 50 Hz. Setting the REJ60 bit to 1 places a notch at 60 Hz (see Figure 66). The output data rate is reduced to 2.78 Hz with this configuration, but the rejection is improved to 94 dB typically at 50 Hz ± 1 Hz and 60 Hz ± 1 Hz.

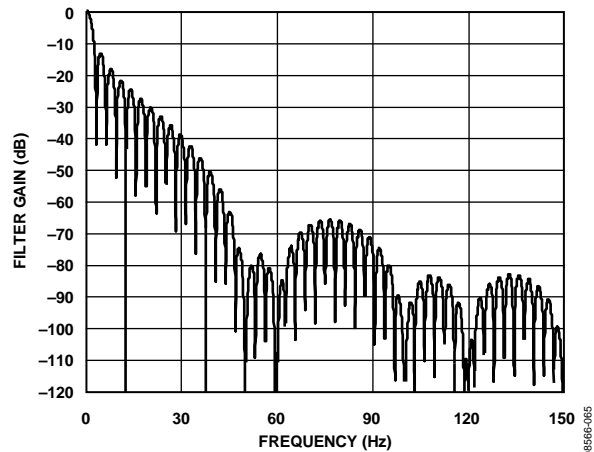

Figure 66. Filter Response for Average + Decimate Filter (Sinc³ Filter, FS[9:0] = 96, Average by 16)

FAST SETTLING MODE (CHOP ENABLED)

Chop can be enabled in the fast settling mode. With chop enabled, the ADC offset and offset drift are minimized. The analog input pins are continuously swapped. With the analog input pins connected in one direction, the settling time of the sinc filter is allowed and a conversion is recorded. The analog input pins are then inverted, and another settled conversion is obtained. Subsequent conversions are averaged so that the offset is minimized. This continuous swapping of the analog

input pins and the averaging of subsequent conversions means that the offset drift is also minimized.

Chopping does not change the output data rate. However, the settling time equals

$$t_{SETTLE} = 2/f_{ADC}$$

Consequently, if chop is enabled, the sinc⁴ filter is selected, FS[9:0] is set to 6 and averaging by 16 is enabled, and the output data rate is equal to 42.1 Hz. Therefore, the conversion time equals 1/42.10 Hz or 23.75 ms and the settling time is equal to 47.5 ms.

SUMMARY OF FILTER OPTIONS

The AD7194 has several filter options. The filter that is chosen affects the output data rate, settling time, the rms noise, the stop band attenuation, and the 50 Hz/60 Hz rejection.

Table 36 shows some sample configurations and the corresponding performance in terms of throughput, settling time and 50 Hz/60 Hz rejection.

Table 36. Filter Summary¹

Filter	FS[9:0]	Output Data Rate (Hz)	Settling Time (ms)	Throughput ² (Hz)	REJ60	50 Hz Rejection (dB) ³
Sinc ⁴ , Chop Disabled ⁴	1	4800	0.83	1200	0	No 50 Hz or 60 Hz rejection
Sinc ⁴ , Chop Disabled	5	960	4.17	240	0	No 50 Hz or 60 Hz rejection
Sinc ³ , Chop Disabled	5	960	3.125	320	0	No 50 Hz or 60 Hz rejection
Sinc ⁴ , Chop Disabled	480	10	400	2.5	0	120 dB (50 Hz and 60 Hz)
Sinc ³ , Chop Disabled	480	10	300	3.33	0	100 dB (50 Hz and 60 Hz)
Sinc ⁴ , Chop Disabled	96	50	80	12.5	0	120 dB (50 Hz only)
Sinc ⁴ , Chop Disabled	96	50	80	12.5	1	82 dB (50 Hz and 60 Hz)
Sinc ³ , Chop Disabled	96	50	60	16.7	0	95 dB (50 Hz only)
Sinc ³ , Chop Disabled	96	50	60	16.7	1	67 dB (50 Hz and 60 Hz)
Sinc ⁴ , Chop Disabled	80	60	66.67	15	0	120 dB (60 Hz only)
Sinc ³ , Chop Disabled	80	60	50	20	0	95 dB (60 Hz only)
Sinc ⁴ , Chop Disabled, Zero Latency	96	12.5	80	12.5	0	120 dB (50 Hz only)
Sinc ⁴ , Chop Disabled, Zero Latency	96	12.5	80	12.5	1	82 dB (50 Hz and 60 Hz)
Sinc ⁴ , Chop Disabled, Zero Latency	80	15	66.67	15	0	120 dB (60 Hz only)
Sinc ⁴ , Chop Enabled	96	12.5	160	6.25	1	80 dB (50 Hz and 60 Hz)
Sinc ³ , Chop Enabled	96	16.7	120	8.33	1	67 dB (50 Hz and 60 Hz)
Fast Settling (Sinc ⁴ , Chop Disabled, Average by 16)	96	2.63	380	2.63	1	100 dB (50 Hz and 60 Hz)
Fast Settling (Sinc ⁴ , Chop Disabled, Average by 16)	96	2.78	360	2.78	1	94 dB (50 Hz and 60 Hz)
Fast Settling (Sinc ⁴ , Chop Disabled, Average by 16)	5	50.53	19.79	50.53	0	40 dB (60 Hz only)
Fast Settling (Sinc ³ , Chop Disabled, Average by 16)	5	53.33	18.75	53.33	0	40 dB (60 Hz only)
Fast Settling (Sinc ⁴ , Chop Disabled, Average by 16)	6	42.10	23.75	42.1	0	40 dB (50 Hz only)
Fast Settling (Sinc ³ , Chop Disabled, Average by 16)	6	44.44	22.5	44.44	0	40 dB (50 Hz only)

¹ These calculations assume a 4.92 MHz stable master clock.

² Throughput is the rate at which conversions are available when several channels are enabled. In zero latency mode, the output data rate and throughput are equal.

³ For fast settling mode, the 50 Hz/60 Hz rejection is measured in a band of ± 0.5 Hz around 50 Hz and/or 60 Hz. For all other modes, a region of ± 1 Hz around 50 Hz and/or 60 Hz is used.

⁴ For output data rates greater than 1 kHz, the sinc⁴ filter is recommended.

GROUNDING AND LAYOUT

Because the analog inputs and reference inputs are differential, most of the voltages in the analog modulator are common-mode voltages. The high common-mode rejection of the part removes common-mode noise on these inputs. The analog and digital supplies to the AD7194 are independent and separately pinned out to minimize coupling between the analog and digital sections of the device. The digital filter provides rejection of broadband noise on the power supplies, except at integer multiples of the modulator sampling frequency.

Connect an R-C filter to each analog input pin to provide rejection at the modulator sampling frequency. A 100 Ω resistor in series with each analog input, a 0.1 μF capacitor between the analog input pins, and a 0.01 μF capacitor from each analog input to AGND are advised.

The digital filter also removes noise from the analog and reference inputs provided that these noise sources do not saturate the analog modulator. As a result, the AD7194 is more immune to noise interference than a conventional high resolution converter. However, because the resolution of the AD7194 is so high and the noise levels from the converter so low, care must be taken with regard to grounding and layout.

The printed circuit board (PCB) that houses the ADC must be designed so that the analog and digital sections are separated and confined to certain areas of the board. This facilitates the use of ground planes that can be easily separated. A minimum etch technique is generally best for ground planes because it gives the best shielding.

Although the AD7194 has separate pins for analog and digital ground, the AGND and DGND pins are tied together internally via the substrate. Therefore, the user must not tie these two pins to separate ground planes unless the ground planes are connected together near the AD7194.

In systems in which the AGND and DGND are connected somewhere else in the system (that is, the power supply of the system), they should not be connected again at the AD7194

because a ground loop results. In these situations, it is recommended that the ground pins of the AD7194 be tied to the AGND plane.

In any layout, the user must keep in mind the flow of currents in the system, ensuring that the paths for all currents are as close as possible to the paths the currents took to reach their destinations. Avoid forcing digital currents to flow through the AGND.

Avoid running digital lines under the device because this couples noise onto the die, and allows the analog ground plane to run under the AD7194 to prevent noise coupling. The power supply lines to the AD7194 must use as wide a trace as possible to provide low impedance paths and reduce the effects of glitches on the power supply line. Shield fast switching signals, like clocks, with digital ground to prevent radiating noise to other sections of the board, and never run clock signals near the analog inputs. Avoid crossover of digital and analog signals. Run traces on opposite sides of the board at right angles to each other. This reduces the effects of feedthrough through the board. A microstrip technique is by far the best, but is not always possible with a double-sided board. In this technique, the component side of the board is dedicated to ground planes, whereas signals are placed on the solder side.

Good decoupling is important when using high resolution ADCs. Decouple all analog supplies with 10 μF tantalum capacitors in parallel with 0.1 μF capacitors to AGND. To achieve the best results from these decoupling components, place them as close as possible to the device, ideally right up against the device. Decouple all logic chips with 0.1 μF ceramic capacitors to DGND. In systems in which a common supply voltage is used to drive both the AV_{DD} and DV_{DD} of the AD7194, it is recommended that the system AV_{DD} supply be used. For this supply, place the recommended analog supply decoupling capacitors between the AV_{DD} pin of the AD7194 and AGND and the recommended digital supply decoupling capacitor between the DV_{DD} pin of the AD7194 and DGND.

APPLICATIONS INFORMATION

The AD7194 provides a low cost, high resolution analog-to-digital function. Because the analog-to-digital function is provided by a Σ - Δ architecture, the part is more immune to noisy environments, making it ideal for use in sensor measurement and industrial and process control applications.

FLOWMETER

Figure 67 shows the AD7194 being used in a flowmeter application that consists of two pressure transducers with the rate of flow being equal to the pressure difference. The pressure transducers are arranged in a bridge network and give a differential output voltage between its OUT+ and OUT- terminals. With rated full-scale pressure (in this case 300 mmHg) on the transducer, the differential output voltage is 3 mV/V of the input voltage (that is, the voltage between the IN+ and IN- terminals).

Assuming a 5 V excitation voltage, the full-scale output range from the transducer is 15 mV. The excitation voltage for the bridge can be used to directly provide the reference for the ADC, as the reference input range includes the supply voltage.

In Figure 67, temperature compensation is performed using a thermistor. In addition, the reference voltage for the temperature measurement is derived from a precision resistor in series with the thermistor. This allows a ratiometric measurement so that variation of the excitation voltage has no effect on the measurement (it is the ratio of the precision reference resistance to the thermistor resistance that is measured).

For simplicity, external filters are not shown in Figure 67; however, an R-C antialias filter must be included on each analog input. This is required because the on-chip digital filter does not provide any rejection around the modulator sampling frequency or multiples of this frequency. Suitable values are a 100 Ω resistor in series with each analog input, a 0.1 μ F capacitor between the analog input pins, and a 0.01 μ F capacitor from each analog input pin to AGND.

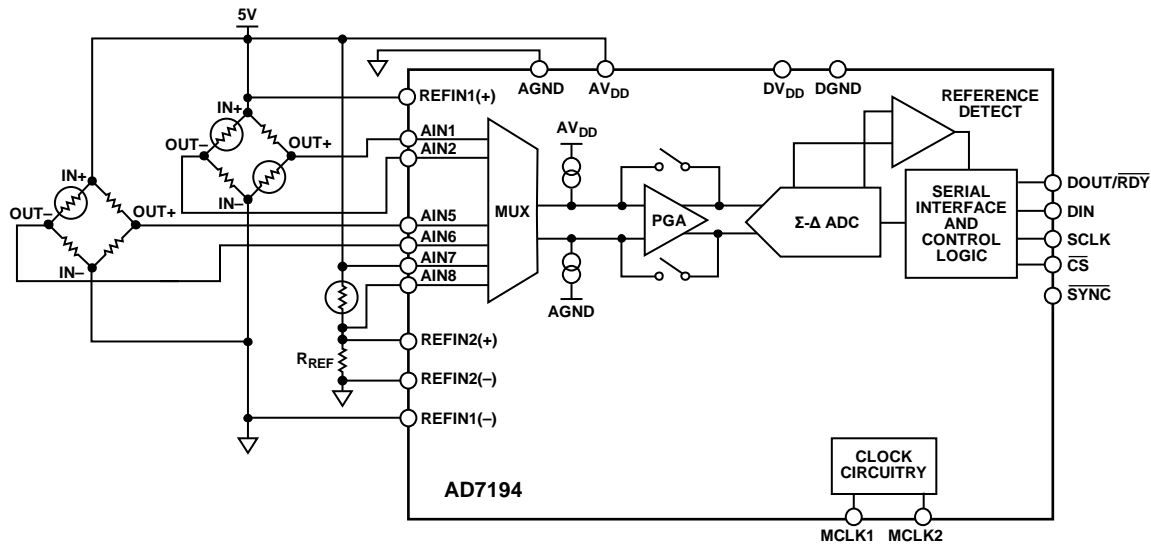
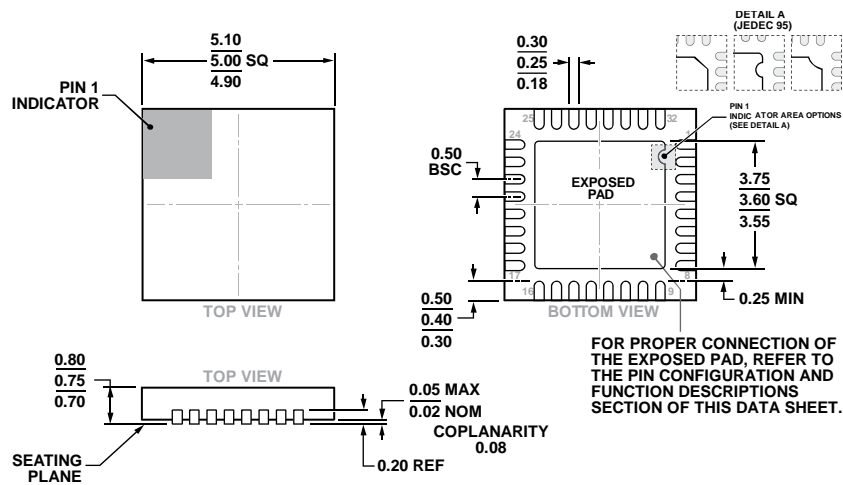

Figure 67. Typical Application (Flowmeter)

01556-086

OUTLINE DIMENSIONS



COMPLIANT TO JEDEC STANDARDS MO-220-WHHD-5.

Figure 68. 32-Lead Lead Frame Chip Scale Package [LFCSP]
 5 mm × 5 mm Body and 0.75 mm Package Height
 (CP-32-12)
 Dimensions shown in millimeters

ORDERING GUIDE

Model ¹	Temperature Range	Package Description	Package Option
AD7194BCPZ	−40°C to +105°C	32-Lead LFCSP	CP-32-12
AD7194BCPZ-REEL	−40°C to +105°C	32-Lead LFCSP	CP-32-12
AD7194BCPZ-REEL7	−40°C to +105°C	32-Lead LFCSP	CP-32-12
EVAL-AD7194EBZ		Evaluation Board	

¹ Z = RoHS Compliant Part.

X-ON Electronics

Largest Supplier of Electrical and Electronic Components

Click to view similar products for [Analog to Digital Converters - ADC category](#):

Click to view products by [Analog Devices manufacturer](#):

Other Similar products are found below :

[ADC0804LCD](#) [ADC0808](#) [MCP37211-200I/TE](#) [MAX15511TGTL+](#) [MCP33141-10T-E/MS](#) [MCP33141D-05T-E/MS](#) [MCP33151D-05T-E/MS](#)
[MCP3202T-CI/MS](#) [MCP33141-05T-E/MS](#) [MCP33141D-10T-E/MS](#) [MCP33151-10T-E/MS](#) [ADE1201ACCZ](#) [ADE1202ACCZ](#) [LTC1090CN](#)
[LTC1605IG](#) [LTC1605AIG](#) [LTC2208IUP](#) [ADS1282HPW](#) [LTC1297DCN8](#) [LTC1741CFW](#) [MCP3422A0-E/MS](#) [MCP3426A2-E/MC](#)
[MCP3427-E/MF](#) [TLC0820ACN](#) [TLC2543IN](#) [TLV2543IDW](#) [NCD9830DBR2G](#) [ADS5231IPAG](#) [ADS7807U](#) [ADS7891IPFBT](#)
[ADS8328IBPW](#) [AMC1204BDWR](#) [ADS7959QDBTRQ1](#) [ADS7807UB](#) [ADS7805UB](#) [ADS1220IPWR](#) [MCP3426A0-E/MS](#) [MCP3423-E/UN](#)
[MCP3422A0-E/MC](#) [AD9220AR](#) [MAX11123ATI+](#) [MAX11212AEUB+](#) [MAX11207EEE+](#) [MAX11135ATI+](#) [TLV1570CDW](#)
[TLC3574IDWR](#) [TLC0838CDWR](#) [AD7714ARZ-5REEL](#) [AD7914BRUZ-REEL7](#) [AD977ABRZ](#)