

FEATURES

Fast throughput rate: 200 kSPS

Specified for AV_{DD} of 2.7 V to 5.25 V

Low power

3.6 mW max at 200 kSPS with 3 V supply

7.5 mW max at 200 kSPS with 5 V supply

4 (single-ended) inputs with sequencer

Wide input bandwidth

70 dB min SNR at 50 kHz input frequency

Flexible power/serial clock speed management

No pipeline delays

High speed serial interface SPI[®]-/QSPI[™]-/MICROWIRE[™]-/DSP-compatible

Shutdown mode: 0.5 μ A max

16-lead TSSOP package

ENHANCED PRODUCT FEATURES

Supports defense and aerospace applications (AQEC standard)

Military temperature range (-55°C to $+125^{\circ}\text{C}$)

Controlled manufacturing baseline

One assembly/test site

One fabrication site

Product change notification

Qualification data available on request

APPLICATIONS

Aerospace and defense

Milcom

Avionics

Unmanned systems

GENERAL DESCRIPTION

The **AD7923-EP** is a 12-bit, high speed, low power, 4-channel, successive approximation (SAR) ADC. It operates from a single 2.7 V to 5.25 V power supply and features throughput rates up to 200 kSPS. It contains a low noise, wide bandwidth track-and-hold amplifier that can handle input frequencies in excess of 8 MHz.

The conversion process and data acquisition are controlled by $\overline{\text{CS}}$ and the serial clock, allowing the device to easily interface with microprocessors or DSPs. The input signal is sampled on the falling edge of $\overline{\text{CS}}$; the conversion is also initiated at this point.

The **AD7923-EP** uses advanced design techniques to achieve very low power dissipation at maximum throughput rates. At maximum throughput rates, it consumes 1.2 mA maximum with 3 V supplies and 1.5 mA maximum with 5 V supplies.

Through the configuration of the control register, the analog input range can be selected as 0 V to REF_{IN} or 0 V to $2 \times \text{REF}_{\text{IN}}$, with either straight binary or twos complement output coding.

Rev. A

Document Feedback

Information furnished by Analog Devices is believed to be accurate and reliable. However, no responsibility is assumed by Analog Devices for its use, nor for any infringements of patents or other rights of third parties that may result from its use. Specifications subject to change without notice. No license is granted by implication or otherwise under any patent or patent rights of Analog Devices. Trademarks and registered trademarks are the property of their respective owners.

FUNCTIONAL BLOCK DIAGRAM

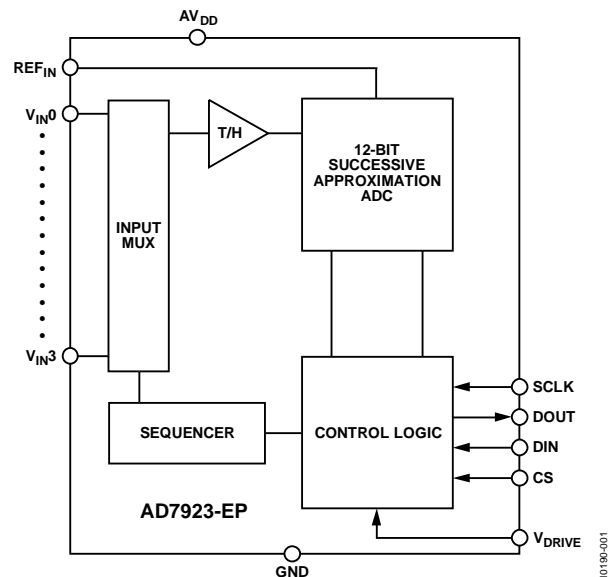

Figure 1.

The **AD7923-EP** features four single-ended analog inputs with a channel sequencer to allow a preprogrammed selection of channels to be converted sequentially.

The serial clock (SCLK) frequency determines the conversion time for the **AD7923-EP** because this is used as the master clock to control the conversion. The conversion time can be as short as 800 ns with a 20 MHz SCLK. Additional application and technical information can be found in the **AD7923** data sheet.

PRODUCT HIGHLIGHTS

1. High Throughput with Low Power Consumption. The **AD7923-EP** offers up to 200 kSPS throughput rates. At the maximum throughput rate with 3 V supplies, the **AD7923-EP** dissipates just 3.6 mW of power.
2. Four Single-Ended Inputs with a Channel Sequencer.
3. Single-Supply Operation with V_{DRIVE} Function. The V_{DRIVE} function allows the serial interface to connect directly to either 3 V or 5 V processor systems independent of AV_{DD} .
4. Flexible Power/Serial Clock Speed Management. The serial clock determines the conversion rate, allowing the conversion time to reduce through the serial clock speed increase. The device also features various shutdown modes to maximize power efficiency at lower throughput rates. Current consumption is 0.5 μ A maximum when in full shutdown.
5. No Pipeline Delay. The device features a SAR ADC with accurate control of the sampling instant via a $\overline{\text{CS}}$ input and once off conversion control.

TABLE OF CONTENTS

Features	1	Absolute Maximum Ratings	6
Enhanced Product Features	1	ESD Caution.....	6
General Description	1	Pin Configuration and Function Description	7
Functional Block Diagram	1	Typical Performance Characteristics	8
Product Highlights	1	Outline Dimensions	9
Specifications.....	3	Ordering Guide	9
Timing Specifications	5		

REVISION HISTORY

4/2018—Rev. 0 to Rev. A

Changes to Features Section.....	1
Added Enhanced Product Features Section.....	1
Changes to Ordering Guide	9

10/2011—Revision 0: Initial Version

SPECIFICATIONS

$AV_{DD} = V_{DRIVE} = 2.7\text{ V to }5.25\text{ V}$, $REF_{IN} = 2.5\text{ V}$, $f_{SCLK} = 20\text{ MHz}$, $T_A = T_{MIN}$ to T_{MAX} , unless otherwise noted. Temperature range (EP version): -55°C to $+125^{\circ}\text{C}$.

Table 1.

Parameter	EP Version ¹	Unit	Test Conditions/Comments
DYNAMIC PERFORMANCE			
Signal-to-(Noise + Distortion) (SINAD)	70	dB min	$f_{IN} = 50\text{ kHz}$ sine wave, $f_{SCLK} = 20\text{ MHz}$ At 5 V , -40°C to $+85^{\circ}\text{C}$
	69	dB min	At 5 V , 85°C to 125°C , typ 70 dB
	69	dB min	At 3 V typ 70 dB , -40°C to $+125^{\circ}\text{C}$
Signal-to-Noise (SNR)	70	dB min	
Total Harmonic Distortion (THD)	-77	dB max	At 5 V typ, -84 dB
	-73	dB max	At 3 V typ, -77 dB
Peak Harmonic or Spurious Noise (SFDR)	-78	dB max	At 5 V typ, -86 dB
	-76	dB max	At 3 V typ, -80 dB
Intermodulation Distortion (IMD)			$f_A = 40.1\text{ kHz}$, $f_B = 41.5\text{ kHz}$
Second Order Terms	-90	dB typ	
Third Order Terms	-90	dB typ	
Aperture Delay	10	ns typ	
Aperture Jitter	50	ps typ	
Channel to Channel Isolation	-85	dB typ	$f_{IN} = 400\text{ kHz}$
Full Power Bandwidth	8.2	MHz typ	at 3 dB
	1.6	MHz typ	At 0.1 dB
DC ACCURACY			
Resolution	12	Bits	
Integral Nonlinearity	± 1	LSB max	
Differential Nonlinearity	$-0.9/+1.5$	LSB max	Guaranteed no missed codes to 12 bits
0 V to REF_{IN} Input Range			Straight binary output coding
Offset Error	± 8	LSB max	Typ $\pm 0.5\text{ LSB}$
Offset Error Match	± 0.5	LSB max	
Gain Error	± 1.5	LSB max	
Gain Error Match	± 0.5	LSB max	
0 V to $2 \times REF_{IN}$ Input Range			$-REF_{IN}$ to $+REF_{IN}$ biased about REF_{IN} with twos complement output coding
Positive Gain Error	± 1.5	LSB max	
Positive Gain Error Match	± 0.5	LSB max	
Zero Code Error	± 8	LSB max	Typ $\pm 0.8\text{ LSB}$
Zero Code Error Match	± 0.5	LSB max	
Negative Gain Error	± 1	LSB max	
Negative Gain Error Match	± 0.5	LSB max	
ANALOG INPUT			
Input Voltage Range	0 to REF_{IN}	V	Range bit set to 1
	0 to $2 \times REF_{IN}$	V	Range bit set to 0, $AV_{DD} = 4.75\text{ V to }5.25\text{ V}$
DC Leakage Current	± 1	μA max	
Input Capacitance	20	pF typ	
REFERENCE INPUT			
REF_{IN} Input Voltage	2.5	V	$\pm 1\%$ specified performance
DC Leakage Current	± 1	μA max	
REF_{IN} Input Impedance	36	k Ω typ	$f_{SAMPLE} = 200\text{ kSPS}$

Parameter	EP Version ¹	Unit	Test Conditions/Comments
LOGIC INPUTS			
Input High Voltage, V_{INH}	$0.7 \times V_{DRIVE}$	V min	Typ 10 nA, $V_{IN} = 0\text{ V}$ or V_{DRIVE}
Input Low Voltage, V_{INL}	$0.3 \times V_{DRIVE}$	V max	
Input Current, I_{IN}	± 1	μA max	
Input Capacitance, C_{IN}^2	10	pF max	
LOGIC OUTPUTS			
Output High Voltage, V_{OH}	$V_{DRIVE} - 0.2$	V min	$I_{SOURCE} = 200\ \mu\text{A}$, $AV_{DD} = 2.7\text{ V}$ to 5.25 V $I_{SINK} = 200\ \mu\text{A}$
Output Low Voltage, V_{OL}	0.4	V max	
Floating State Leakage Current	± 1	μA max	Coding bit set to 0 Coding bit set to 1
Floating State Output Capacitance ²	1	pF max	
Output Coding	Twos Complement Straight (Natural) Binary		
CONVERSION RATE			
Conversion Time	800	ns max	16 SCLK cycles with SCLK at 20 MHz Sinewave input Full-scale step Input
Track-and-Hold Acquisition Time	300	ns max	
	300	ns max	
Throughput Rate	200	kSPS max	
POWER REQUIREMENTS			
AV_{DD}	2.7/5.25	V min/max	Digital I/Ps = 0 V or V_{DRIVE} $AV_{DD} = 4.75\text{ V}$ to 5.25 V , $f_{SCLK} = 20\text{ MHz}$ $AV_{DD} = 2.7\text{ V}$ to 3.6 V , $f_{SCLK} = 20\text{ MHz}$ $AV_{DD} = 2.7\text{ V}$ to 5.25 V , SCLK on or off $AV_{DD} = 4.75\text{ V}$ to 5.25 V , $f_{SCLK} = 20\text{ MHz}$ $AV_{DD} = 2.7\text{ V}$ to 3.6 V , $f_{SCLK} = 20\text{ MHz}$ $AV_{DD} = 4.75\text{ V}$ to 5.25 V , $f_{SAMPLE} = 200\text{ kSPS}$ $AV_{DD} = 2.7\text{ V}$ to 3.6 V , $f_{SAMPLE} = 200\text{ kSPS}$ SCLK on or off (20 nA typ) SCLK on or off (20 nA typ) $AV_{DD} = 5\text{ V}$, $f_{SCLK} = 20\text{ MHz}$ $AV_{DD} = 3\text{ V}$, $f_{SCLK} = 20\text{ MHz}$ $AV_{DD} = 5\text{ V}$ $AV_{DD} = 3\text{ V}$ $AV_{DD} = 5\text{ V}$ $AV_{DD} = 3\text{ V}$
V_{DRIVE}	2.7/5.25	V min/max	
I_{DD}			
During Conversion	2.7	mA max	
	2.0	mA max	
Normal Mode (Static)	600	μA typ	
Normal Mode (Operational) $f_{SAMPLE} = 200\text{ kSPS}$	1.5	mA max	
	1.2	mA max	
Using Auto Shutdown Mode $f_{SAMPLE} = 200\text{ kSPS}$	900	μA typ	
	650	μA typ	
Auto Shutdown (Static)	0.5	μA max	
Full Shutdown Mode	0.5	μA max	
Power Dissipation			
Normal Mode (Operational) $f_{SAMPLE} = 200\text{ kSPS}$	7.5	mW max	
	3.6	mW max	
Auto Shutdown (Static)	2.5	μW max	
	1.5	μW max	
Full Shutdown Mode	2.5	μW max	
	1.5	μW max	

¹ Temperature range: EP Version: -55°C to $+125^{\circ}\text{C}$.² Sample tested at 25°C to ensure compliance.

TIMING SPECIFICATIONS

$AV_{DD} = 2.7\text{ V to }5.25\text{ V}$, $V_{DRIVE} \leq AV_{DD}$, $REF_{IN} = 2.5\text{ V}$, $T_A = T_{MIN}\text{ to }T_{MAX}$, unless otherwise noted.¹

Table 2.

Parameter	Limit at T_{MIN} , T_{MAX}		Unit	Description
	$AV_{DD} = 3\text{ V}$	$AV_{DD} = 5\text{ V}$		
f_{SCLK}^2	10	10	kHz min	
	20	20	MHz max	
$t_{CONVERT}$	$16 \times t_{SCLK}$	$16 \times t_{SCLK}$		
t_{QUIET}	50	50	ns min	Minimum quiet time required between \overline{CS} rising edge and start of next conversion
t_2	10	10	ns min	\overline{CS} to SCLK set up time
t_3^3	35	30	ns max	Delay from \overline{CS} until DOUT three-state disabled
t_4^3	40	40	ns max	Data access time after SCLK falling edge
t_5	$0.4 \times t_{SCLK}$	$0.4 \times t_{SCLK}$	ns min	SCLK low pulse width
t_6	$0.4 \times t_{SCLK}$	$0.4 \times t_{SCLK}$	ns min	SCLK high pulse width
t_7	10	10	ns min	SCLK to DOUT valid hold time
t_8^4	15/45	15/35	ns min/max	SCLK falling edge to DOUT high impedance
t_9	10	10	ns min	DIN set up time prior to SCLK falling edge
t_{10}	5	5	ns min	DIN hold time after SCLK falling edge
t_{11}	20	20	ns min	Sixteenth SCLK falling edge to \overline{CS} high
t_{12}	1	1	$\mu\text{s max}$	Power-Up time from full power-down/auto shutdown mode

¹ Sample tested at 25°C to ensure compliance. All input signals are specified with $t_r = t_f = 5\text{ ns}$ (10% to 90% of AV_{DD}) and timed from a voltage level of 1.6 V. See Figure 2. The 3 V operating range spans from 2.7 V to 3.6 V. The 5 V operating range spans from 4.75 V to 5.25 V.

² The mark/space ratio for the SCLK input is 40/60 to 60/40.

³ Measured with the load circuit of Figure 2 and defined as the time required for the output to cross 0.4 V or $0.7 \times V_{DRIVE}$.

⁴ t_8 is derived from the measured time taken by the data outputs to change 0.5 V when loaded with the circuit of Figure 2. The measured number is then extrapolated back to remove the effects of charging or discharging the 50 pF capacitor. This means that the time, quoted in the timing characteristics t_8 , is the true bus relinquish time of the device and is independent of the bus loading.

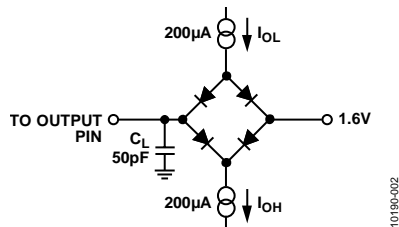

Figure 2. Load Circuit for Digital Output Timing Specification

10190-002

ABSOLUTE MAXIMUM RATINGS

$T_A = 25^\circ\text{C}$, unless otherwise noted.

Table 3.

Parameter	Rating
AVDD to AGND	-0.3 V to +7 V
V _{DRIVE} to AGND	-0.3 V to AV _{DD} + 0.3 V
Analog Input Voltage to AGND	-0.3 V to AV _{DD} + 0.3 V
Digital Input Voltage to AGND	-0.3 V to +7 V
Digital Output Voltage to AGND	-0.3 V to AV _{DD} + 0.3 V
REF _{IN} to AGND	-0.3 V to AV _{DD} + 0.3 V
Input Current to Any Pin Except Supplies ¹	±10 mA
Operating Temperature Range (EP Version)	-55°C to +125°C
Storage Temperature Range	-65°C to +150°C
Junction Temperature	150°C
TSSOP Package, Power Dissipation	450 mW
θ _{JA} Thermal Impedance	150.4°C/W (TSSOP)
θ _{JC} Thermal Impedance	27.6°C/W (TSSOP)
Lead Temperature, Soldering	
Vapor Phase (60 sec)	215°C
Infrared (15 sec)	220°C
Pb-free Temperature, Soldering	
Reflow	260(+0)°C
ESD	1.5 kV

¹ Transient currents of up to 100 mA do not cause SCR latchup.

Stresses at or above those listed under Absolute Maximum Ratings may cause permanent damage to the product. This is a stress rating only; functional operation of the product at these or any other conditions above those indicated in the operational section of this specification is not implied. Operation beyond the maximum operating conditions for extended periods may affect product reliability.

ESD CAUTION



ESD (electrostatic discharge) sensitive device. Charged devices and circuit boards can discharge without detection. Although this product features patented or proprietary protection circuitry, damage may occur on devices subjected to high energy ESD. Therefore, proper ESD precautions should be taken to avoid performance degradation or loss of functionality.

PIN CONFIGURATION AND FUNCTION DESCRIPTION

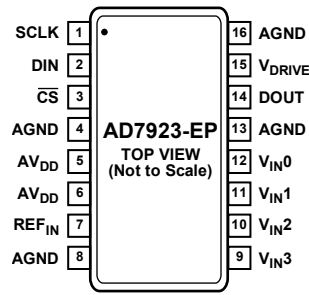

Figure 3. Pin Configuration

10190-003

Table 4. Pin Function Descriptions

Pin No.	Mnemonic	Description
1	SCLK	Serial Clock. Logic Input. SCLK provides the serial clock for accessing data for the device. This clock input is also used as the clock source for the AD7923-EP conversion process.
2	DIN	Data In. Logic Input. Data to be written to the control register is provided on this input and is clocked into the register on the falling edge of SCLK.
3	\overline{CS}	Chip Select. Active low logic input. This input provides the dual function of initiating conversions on the AD7923-EP and framing the serial data transfer.
4, 8, 13, 16	AGND	Analog Ground. Ground reference point for all analog circuitry on the AD7923-EP . All analog input signals and any external reference signal should be referred to this AGND voltage. All AGND pins should be connected together.
5, 6	AV _{DD}	Analog Power Supply Input. The AV _{DD} range for the AD7923-EP is from 2.7 V to 5.25 V. For the 0 V to 2 × REF _{IN} range, AV _{DD} should be from 4.75 V to 5.25 V.
7	REF _{IN}	Reference Input for the AD7923-EP . An external reference must be applied to this input. The voltage range for the external reference is 2.5 V ± 1% for specified performance.
12 to 9	V _{IN0} to V _{IN3}	Analog Input 0 through Analog Input 3. Four single-ended analog input channels that are multiplexed into the on-chip track-and-hold. The analog input channel to be converted is selected by using the Address Bits ADD1 and ADD0 of the control register. The address bits in conjunction with the SEQ1 and SEQ0 bits allow the sequencer to be programmed. The input range for all input channels can extend from 0 V to REF _{IN} or from 0 V to 2 × REF _{IN} as selected via the range bit in the control register. Any unused input channels must be connected to AGND to avoid noise pickup.
14	DOUT	Data Out. Logic Output. The conversion result from the AD7923-EP is provided on this output pin as a serial data stream. The AD7923-EP serial data stream consists of two leading 0s, and two address bits indicating which channel the conversion result corresponds to, followed by 12 bits of conversion data, MSB first. The output coding can be selected as straight binary or twos complement via the coding bit in the control register. The data bits are clocked out of the AD7923-EP on the SCLK falling edge.
15	V _{DRIVE}	Logic Power Supply Input. The voltage supplied at this pin determines at which voltage the serial interface operates.

TYPICAL PERFORMANCE CHARACTERISTICS

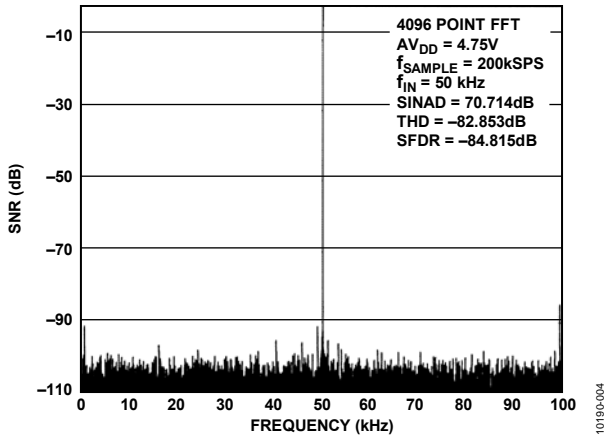

Figure 4. Dynamic Performance at 200 kSPS

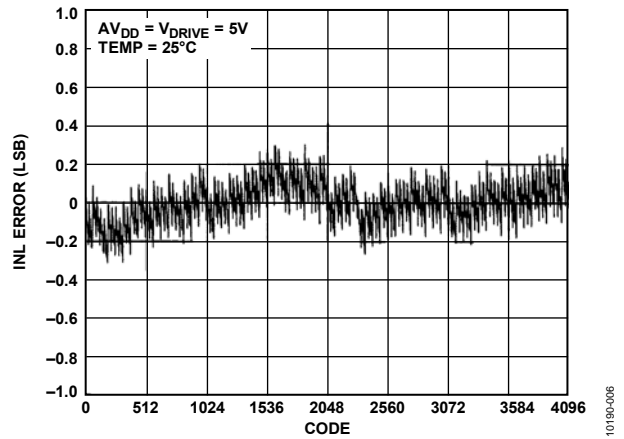

Figure 6. Typical INL

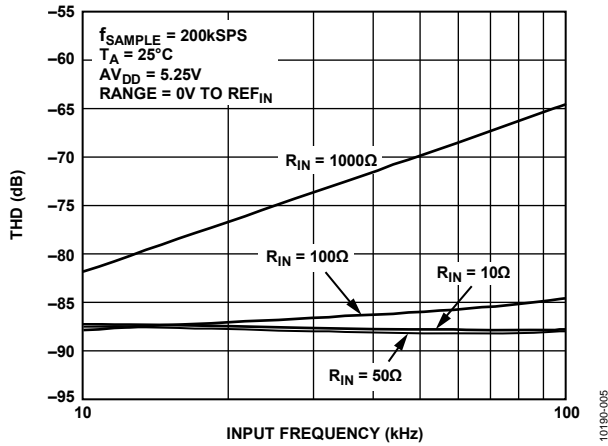

Figure 5. THD vs. Analog Input Frequency for Various Source Impedances

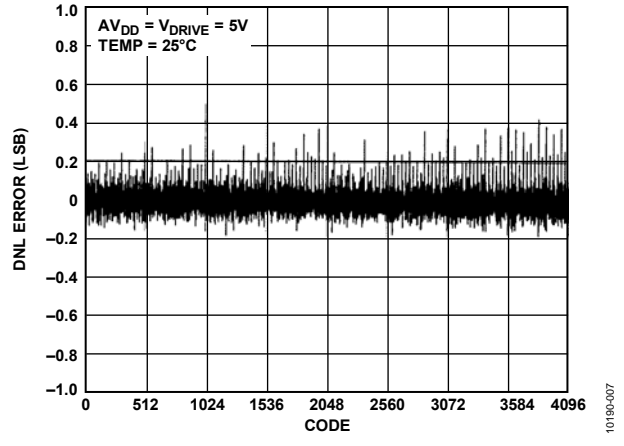
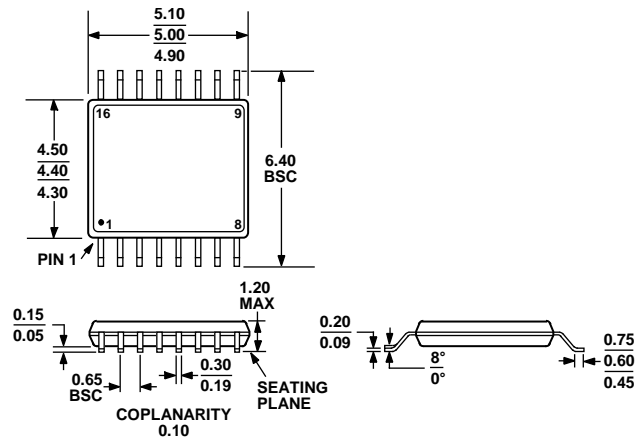

Figure 7. Typical DNL

OUTLINE DIMENSIONS



COMPLIANT TO JEDEC STANDARDS MO-153-AB

Figure 8. 16-Lead Thin Shrink Small Outline Package [TSSOP]
(RU-16)

Dimensions shown in millimeters

ORDERING GUIDE

Model ¹	Temperature Range	Linearity Error (LSB) ²	Package Description	Package Option
AD7923SRU-EP	-55°C to +125°C	±1	16-Lead Thin Shrink Small Outline Package [TSSOP]	RU-16
AD7923SRU-EP-RL7	-55°C to +125°C	±1	16-Lead Thin Shrink Small Outline Package [TSSOP]	RU-16
AD7923SRUZ-EP	-55°C to +125°C	±1	16-Lead Thin Shrink Small Outline Package [TSSOP]	RU-16
AD7923SRUZ-EP-RL7	-55°C to +125°C	±1	16-Lead Thin Shrink Small Outline Package [TSSOP]	RU-16

¹ Z = RoHS Compliant Part² Linearity error refers to integral linearity error.

X-ON Electronics

Largest Supplier of Electrical and Electronic Components

Click to view similar products for [Analog to Digital Converters - ADC category](#):

Click to view products by [Analog Devices manufacturer](#):

Other Similar products are found below :

[ADC0804LCD](#) [ADC0808](#) [MCP37211-200I/TE](#) [MAX15511TGTL+](#) [MCP33141-10T-E/MS](#) [MCP33141D-05T-E/MS](#) [MCP33151D-05T-E/MS](#)
[MCP3202T-CI/MS](#) [MCP33141-05T-E/MS](#) [MCP33141D-10T-E/MS](#) [MCP33151-05T-E/MS](#) [MCP33151-10T-E/MS](#) [ADE1201ACCZ](#)
[ADE1202ACCZ](#) [LTC1090CN](#) [LTC1605IG](#) [LTC1605AIG](#) [LTC2208IUP](#) [ADS1282HPW](#) [LTC1297DCN8](#) [LTC1741CFW](#) [MCP3422A0-](#)
[E/MS](#) [MCP3426A2-E/MC](#) [MCP3426A3-E/MC](#) [MCP3427-E/MF](#) [TLC0820ACN](#) [TLC2543IN](#) [TLV2543IDW](#) [NCD9830DBR2G](#)
[ADS5231IPAG](#) [ADS7807U](#) [ADS7891IPFBT](#) [ADS8328IBPW](#) [AMC1204BDWR](#) [ADS7959QDBTRQ1](#) [ADS7807UB](#) [ADS7805UB](#)
[ADS1220IPWR](#) [MCP3426A0-E/MS](#) [MCP3423-E/UN](#) [MCP3422A0-E/MC](#) [AD9220AR](#) [MAX11123ATI+](#) [MAX11212AEUB+](#)
[MAX11135ATI+](#) [TLV1570CDW](#) [TLC3574IDWR](#) [TLC0838CDWR](#) [AD7714ARZ-5REEL](#) [AD7914BRUZ-REEL7](#)