

## FEATURES

### High speed

- 1.5 GHz,  $-3$  dB bandwidth ( $G = +1$ )
- 650 MHz, full power bandwidth ( $G = +2$ ,  $V_o = 2$  V p-p)
- Slew rate: 4100 V/ $\mu$ s
- 0.1% settling time: 12 ns

### Excellent video specifications

- 0.1 dB flatness: 170 MHz
- Differential gain: 0.02%
- Differential phase: 0.01°

### Output overdrive recovery: 22 ns

### Low noise: 1.6 nV/ $\sqrt{\text{Hz}}$ input voltage noise

### Low distortion over wide bandwidth

- 75 dBc SFDR at 20 MHz
- 62 dBc SFDR at 50 MHz

### Input offset voltage: 1 mV typical

### High output current: 100 mA

### Wide supply voltage range: 4.5 V to 12 V

### Supply current: 13.5 mA

### Power-down mode

## APPLICATIONS

- Professional video
- High speed instrumentation
- Video switching
- IF/RF gain stage
- CCD imaging

## GENERAL DESCRIPTION

The **AD8000** is an ultrahigh speed, high performance, current feedback amplifier. Using Analog Devices, Inc., proprietary eXtra Fast Complementary Bipolar (XFCB) process, the amplifier can achieve a small signal bandwidth of 1.5 GHz and a slew rate of 4100 V/ $\mu$ s.

The **AD8000** has low spurious-free dynamic range (SFDR) of 75 dBc at 20 MHz and input voltage noise of 1.6 nV/ $\sqrt{\text{Hz}}$ . The **AD8000** can drive over 100 mA of load current with minimal distortion. The amplifier can operate on +5 V to  $\pm 6$  V. These specifications make the **AD8000** ideal for a variety of applications, including high speed instrumentation.

With a differential gain of 0.02%, differential phase of 0.01°, and 0.1 dB flatness out to 170 MHz, the **AD8000** has excellent video specifications, which ensure that even the most demanding video systems maintain excellent fidelity.

## CONNECTION DIAGRAMS

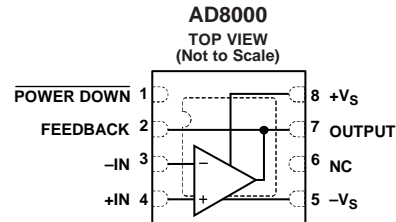

- NOTES
1. NC = NO CONNECT.
  2. THE EXPOSED PADDLE IS CONNECTED TO GROUND.

Figure 1. 8-Lead **AD8000**, 3 mm  $\times$  3 mm LFCSP (CP-8-13)

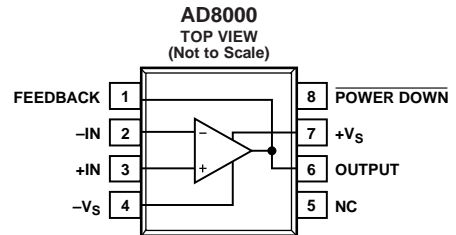

- NOTES
1. NC = NO CONNECT.
  2. THE EXPOSED PADDLE IS CONNECTED TO GROUND.

Figure 2. 8-Lead **AD8000** SOIC\_N\_EP (RD-8-1)

The **AD8000** power-down mode reduces the supply current to 1.3 mA. The amplifier is available in a tiny 8-lead LFCSP package, as well as in an 8-lead SOIC package. The **AD8000** is rated to work over the extended industrial temperature range ( $-40^\circ\text{C}$  to  $+125^\circ\text{C}$ ). A triple version of the **AD8000** (**AD8003**) is underdevelopment.

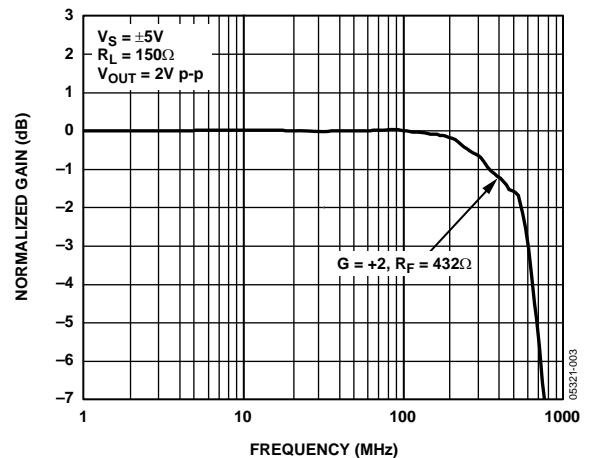

Figure 3. Large Signal Frequency Response

### Rev. C

### Document Feedback

Information furnished by Analog Devices is believed to be accurate and reliable. However, no responsibility is assumed by Analog Devices for its use, nor for any infringements of patents or other rights of third parties that may result from its use. Specifications subject to change without notice. No license is granted by implication or otherwise under any patent or patent rights of Analog Devices. Trademarks and registered trademarks are the property of their respective owners.

## TABLE OF CONTENTS

Features .....	1	Applications Information .....	14
Applications.....	1	Circuit Configurations .....	14
General Description .....	1	Video Line Driver .....	14
Connection Diagrams .....	1	Low Distortion Pinout .....	15
Revision History .....	2	Exposed Paddle.....	15
Specifications with $\pm 5$ V Supply .....	3	Printed Circuit Board Layout .....	15
Specifications with +5 V Supply .....	4	Signal Routing.....	15
Absolute Maximum Ratings.....	5	Power Supply Bypassing.....	15
Thermal Resistance .....	5	Grounding .....	16
Maximum Power Dissipation .....	5	Outline Dimensions .....	17
ESD Caution.....	5	Ordering Guide .....	17
Typical Performance Characteristics .....	6		
Test Circuits.....	13		

## REVISION HISTORY

### 5/16—Rev. B to Rev. C

Changed CP-8-2 to CP-8-13 .....	Throughout
Updated Outline Dimensions .....	17
Changes to Ordering Guide .....	17

### 3/13—Rev. A to Rev. B

Changes to Figure 1 and Figure 2 .....	1
Change to Table 1 .....	3
Changes to Table 2.....	4
Updated Outline Dimensions .....	17
Changes to Ordering Guide .....	17

### 3/10—Rev. 0 to Rev. A

Changes to Figure 1 and Figure 2 .....	1
Changes to Table 3.....	5
Updated Outline Dimensions .....	17
Changes to Ordering Guide .....	17

### 1/05—Rev. 0: Initial Version

## SPECIFICATIONS WITH $\pm 5$ V SUPPLY

At  $T_A = 25^\circ\text{C}$ ,  $V_S = \pm 5$  V,  $R_L = 150$   $\Omega$ , Gain = +2,  $R_F = R_G = 432$   $\Omega$ , unless otherwise noted. Connect the exposed paddle to ground.

Table 1.

Parameter	Test Conditions/Comments	Min	Typ	Max	Unit
<b>DYNAMIC PERFORMANCE</b>					
-3 dB Bandwidth	$G = +1$ , $V_O = 0.2$ V p-p, SOIC/LFCSP		1580/1350		MHz
	$G = +2$ , $V_O = 2$ V p-p, SOIC/LFCSP		650/610		MHz
Bandwidth for 0.1 dB Flatness	$V_O = 2$ V p-p, SOIC/LFCSP		190/170		MHz
Slew Rate	$G = +2$ , $V_O = 4$ V step		4100		V/ $\mu$ s
Settling Time to 0.1%	$G = +2$ , $V_O = 2$ V step		12		ns
<b>NOISE/HARMONIC PERFORMANCE</b>					
Second/Third Harmonic	$V_O = 2$ V p-p, $f = 5$ MHz, LFCSP only		86/89		dBc
Second/Third Harmonic	$V_O = 2$ V p-p, $f = 20$ MHz, LFCSP only		75/79		dBc
Input Voltage Noise	$f = 100$ kHz		1.6		nV/ $\sqrt{\text{Hz}}$
Input Current Noise	$f = 100$ kHz, -IN		26		pA/ $\sqrt{\text{Hz}}$
	$f = 100$ kHz, +IN		3.4		pA/ $\sqrt{\text{Hz}}$
Differential Gain Error	NTSC, $G = +2$		0.02		%
Differential Phase Error	NTSC, $G = +2$		0.01		Degree
<b>DC PERFORMANCE</b>					
Input Offset Voltage			1	10	mV
Input Offset Voltage Drift			11		$\mu\text{V}/^\circ\text{C}$
Input Bias Current (Enabled)	+IB		-5	+4	$\mu\text{A}$
	-IB		-3	+45	$\mu\text{A}$
Transimpedance		570	890	1600	k $\Omega$
<b>INPUT CHARACTERISTICS</b>					
Noninverting Input Impedance			2/3.6		M $\Omega$ /pF
Input Common-Mode Voltage Range			-3.5 to +3.5		V
Common-Mode Rejection Ratio	$V_{CM} = \pm 2.5$ V	-52	-54	-56	dB
Overdrive Recovery	$G = +1$ , $f = 1$ MHz, triangle wave		30		ns
<b>POWER DOWN PIN</b>					
Power-Down Input Voltage	Power-down		< + $V_S - 3.1$		V
	Enabled		> + $V_S - 1.9$		V
Turn-Off Time	50% of power-down voltage to 10% of $V_{OUT}$ final, $V_{IN} = 0.3$ V p-p		150		ns
Turn-On Time	50% of power-down voltage to 90% of $V_{OUT}$ final, $V_{IN} = 0.3$ V p-p		300		ns
Input Bias Current					
Enabled		-1.1	+0.17	+1.4	$\mu\text{A}$
Power-Down		-300	-235	-160	$\mu\text{A}$
<b>OUTPUT CHARACTERISTICS</b>					
Output Voltage Swing	$R_L = 100$ $\Omega$	$\pm 3.7$	$\pm 3.9$		V
Output Voltage Swing	$R_L = 1$ k $\Omega$	$\pm 3.9$	$\pm 4.1$		V
Linear Output Current	$V_O = 2$ V p-p, second HD < -50 dBc		100		mA
Overdrive Recovery	$G = +2$ , $f = 1$ MHz, triangle wave		45		ns
	$G = +2$ , $V_{IN} = 2.5$ V to 0 V step		22		ns
<b>POWER SUPPLY</b>					
Operating Range		4.5		12	V
Quiescent Current		12.7	13.5	14.3	mA
Quiescent Current (Power-Down)		1.1	1.3	1.65	mA
Power Supply Rejection Ratio	-PSRR/+PSRR	-56/-61	-59/-63		dB

## SPECIFICATIONS WITH +5 V SUPPLY

At  $T_A = 25^\circ\text{C}$ ,  $V_S = 5\text{ V}$ ,  $R_L = 150\ \Omega$ , Gain = +2,  $R_F = R_G = 432\ \Omega$ , unless otherwise noted. Connect the exposed paddle to ground.

Table 2.

Parameter	Test Conditions/Comments	Min	Typ	Max	Unit
<b>DYNAMIC PERFORMANCE</b>					
-3 dB Bandwidth	$G = +1, V_O = 0.2\text{ V p-p}$		980		MHz
	$G = +2, V_O = 2\text{ V p-p}$		477		MHz
	$G = +10, V_O = 0.2\text{ V p-p}$		328		MHz
Bandwidth for 0.1 dB Flatness	$V_O = 0.2\text{ V p-p}$		136		MHz
	$V_O = 2\text{ V p-p}$		136		MHz
Slew Rate	$G = +2, V_O = 2\text{ V step}$		2700		V/ $\mu\text{s}$
Settling Time to 0.1%	$G = +2, V_O = 2\text{ V step}$		16		ns
<b>NOISE/HARMONIC PERFORMANCE</b>					
Second/Third Harmonic	$V_O = 2\text{ V p-p}, 5\text{ MHz}, \text{LFCSP only}$		71/71		dBc
Second/Third Harmonic	$V_O = 2\text{ V p-p}, 20\text{ MHz}, \text{LFCSP only}$		60/62		dBc
Input Voltage Noise	$f = 100\text{ kHz}$		1.6		nV/ $\sqrt{\text{Hz}}$
Input Current Noise	$f = 100\text{ kHz}, -\text{IN}$		26		pA/ $\sqrt{\text{Hz}}$
	$f = 100\text{ kHz}, +\text{IN}$		3.4		pA/ $\sqrt{\text{Hz}}$
Differential Gain Error	NTSC, $G = +2$		0.01		%
Differential Phase Error	NTSC, $G = +2$		0.06		Degree
<b>DC PERFORMANCE</b>					
Input Offset Voltage			1.3	10	mV
Input Offset Voltage Drift			18		$\mu\text{V}/^\circ\text{C}$
Input Bias Current (Enabled)	+ $I_B$		-5	+3	$\mu\text{A}$
	- $I_B$		-1	+45	$\mu\text{A}$
Transimpedance		440	800	1500	k $\Omega$
<b>INPUT CHARACTERISTICS</b>					
Noninverting Input Impedance			2/3.6		M $\Omega$ /pF
Input Common-Mode Voltage Range			1.5 to 3.6		V
Common-Mode Rejection Ratio	$V_{CM} = \pm 2.5\text{ V}$	-51	-52	-54	dB
Overdrive Recovery	$G = +1, f = 1\text{ MHz}, \text{triangle wave}$		60		ns
<b>POWER DOWN PIN</b>					
Power-Down Input Voltage	Power-down		< $+V_S - 3.1$		V
	Enable		> $+V_S - 1.9$		V
Turn-Off Time	50% of power-down voltage to 10% of $V_{OUT}$ final, $V_{IN} = 0.3\text{ V p-p}$		200		ns
Turn-On Time	50% of power-down voltage to 90% of $V_{OUT}$ final, $V_{IN} = 0.3\text{ V p-p}$		300		ns
Input Current	Enabled	-1.1	+0.17	+1.4	$\mu\text{A}$
	Power-Down	-50	-40	-30	$\mu\text{A}$
<b>OUTPUT CHARACTERISTICS</b>					
Output Voltage Swing	$R_L = 100\ \Omega$	1.1 to 3.9	1.05 to 4.1		V
	$R_L = 1\ \text{k}\Omega$	1 to 4.0	0.85 to 4.15		V
Linear Output Current	$V_O = 2\text{ V p-p}, \text{second HD} < -50\text{ dBc}$		70		mA
Overdrive Recovery	$G = +2, f = 100\text{ kHz}, \text{triangle wave}$		65		ns
<b>POWER SUPPLY</b>					
Operating Range		4.5		12	V
Quiescent Current		11	12	13	mA
Quiescent Current (Power-Down)		0.7	0.95	1.25	mA
Power Supply Rejection Ratio	-PSRR/+PSRR	-55/-60	-57/-62		dB

## ABSOLUTE MAXIMUM RATINGS

Table 3.

Parameter	Rating
Supply Voltage	12.6 V
Power Dissipation	See Figure 4
Common-Mode Input Voltage Range	$-V_S - 0.7$ V to $+V_S + 0.7$ V
Differential Input Voltage	$\pm V_S$
Storage Temperature Range	$-65^\circ\text{C}$ to $+125^\circ\text{C}$
Operating Temperature Range	$-40^\circ\text{C}$ to $+125^\circ\text{C}$
Lead Temperature (Soldering, 10 sec)	$300^\circ\text{C}$
Junction Temperature	$150^\circ\text{C}$

Stresses at or above those listed under Absolute Maximum Ratings may cause permanent damage to the product. This is a stress rating only; functional operation of the product at these or any other conditions above those indicated in the operational section of this specification is not implied. Operation beyond the maximum operating conditions for extended periods may affect product reliability.

### THERMAL RESISTANCE

$\theta_{JA}$  is specified for the worst-case conditions, that is,  $\theta_{JA}$  is specified for device soldered in the circuit board for surface-mount packages.

Table 4. Thermal Resistance

Package Type	$\theta_{JA}$	$\theta_{JC}$	Unit
8-Lead SOIC	80	30	$^\circ\text{C}/\text{W}$
3 mm $\times$ 3 mm LFCSP	93	35	$^\circ\text{C}/\text{W}$

### MAXIMUM POWER DISSIPATION

The maximum safe power dissipation for the AD8000 is limited by the associated rise in junction temperature ( $T_J$ ) on the die. At approximately  $150^\circ\text{C}$ , which is the glass transition temperature, the properties of the plastic change. Even temporarily exceeding this temperature limit can change the stresses that the package exerts on the die, permanently shifting the parametric performance of the AD8000. Exceeding a junction temperature of  $175^\circ\text{C}$  for an extended period of time can result in changes in silicon devices, potentially causing degradation or loss of functionality.

The power dissipated in the package ( $P_D$ ) is the sum of the quiescent power dissipation and the power dissipated in the die due to the AD8000 drive at the output. The quiescent power is the voltage between the supply pins ( $V_S$ ) times the quiescent current ( $I_S$ ).

$$P_D = \text{Quiescent Power} + (\text{Total Drive Power} - \text{Load Power})$$

$$P_D = (V_S \times I_S) + \left( \frac{V_S}{2} \times \frac{V_{OUT}}{R_L} \right) - \frac{V_{OUT}^2}{R_L}$$

Consider the RMS output voltages. If  $R_L$  is referenced to  $-V_S$ , as in single-supply operation, the total drive power is  $V_S \times I_{OUT}$ . If the rms signal levels are indeterminate, consider the worst case, when  $V_{OUT} = V_S/4$  for  $R_L$  to midsupply.

$$P_D = (V_S \times I_S) + \frac{(V_S/4)^2}{R_L}$$

In single-supply operation with  $R_L$  referenced to  $-V_S$ , worst case is  $V_{OUT} = V_S/2$ .

Airflow increases heat dissipation, effectively reducing  $\theta_{JA}$ . Also, more metal directly in contact with the package leads and exposed paddle from metal traces, through holes, ground, and power planes reduces  $\theta_{JA}$ .

Figure 4 shows the maximum safe power dissipation in the package vs. the ambient temperature for the exposed paddle SOIC ( $80^\circ\text{C}/\text{W}$ ) and the LFCSP ( $93^\circ\text{C}/\text{W}$ ) package on a JEDEC standard 4-layer board.  $\theta_{JA}$  values are approximations.

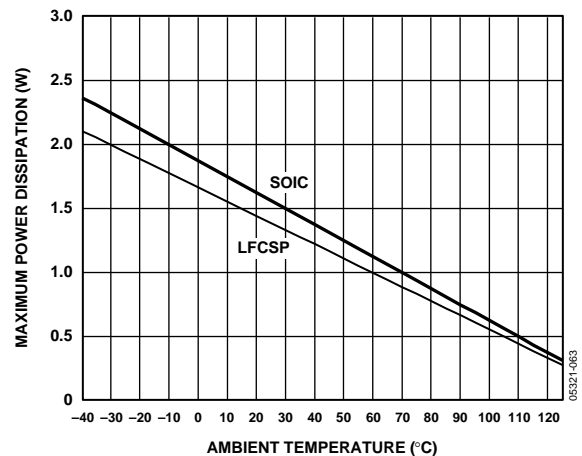

Figure 4. Maximum Power Dissipation vs. Temperature for a 4-Layer Board

### ESD CAUTION



#### ESD (electrostatic discharge) sensitive device.

Charged devices and circuit boards can discharge without detection. Although this product features patented or proprietary protection circuitry, damage may occur on devices subjected to high energy ESD. Therefore, proper ESD precautions should be taken to avoid performance degradation or loss of functionality.

TYPICAL PERFORMANCE CHARACTERISTICS

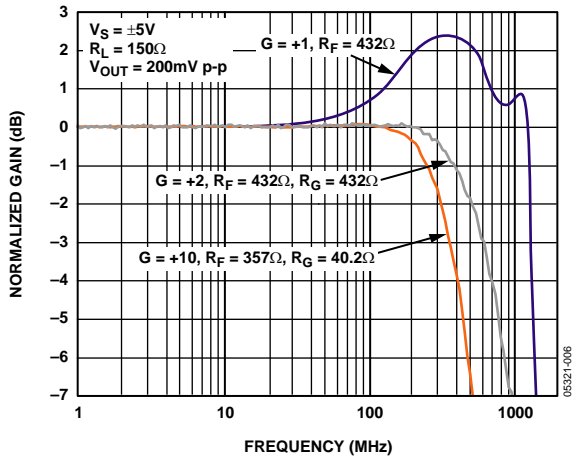

Figure 5. Small Signal Frequency Response vs. Various Gains

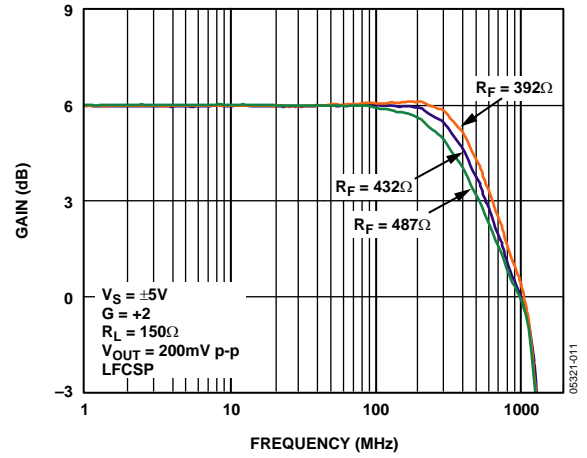

Figure 8. Small Signal Frequency Response vs.  $R_F$

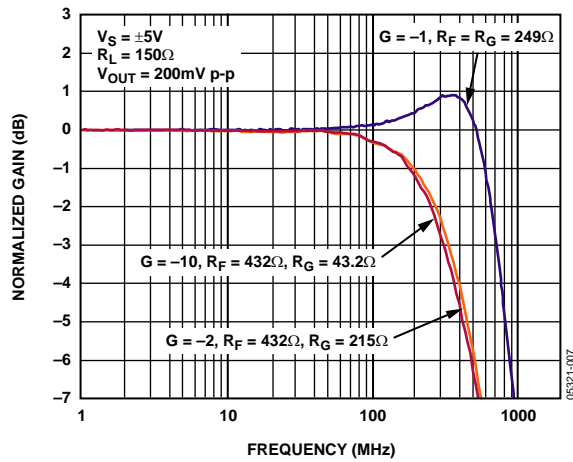

Figure 6. Small Signal Frequency Response vs. Various Gains

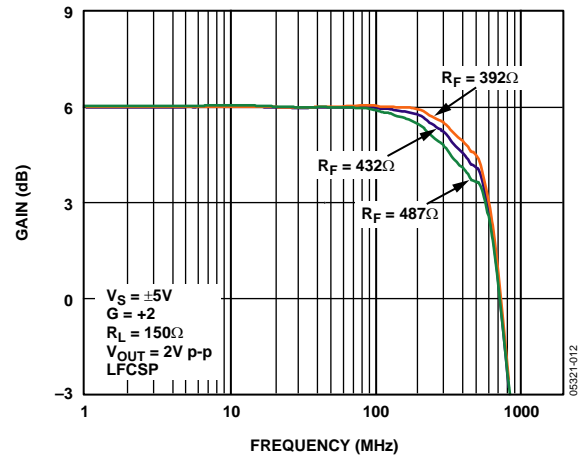

Figure 9. Large Signal Frequency Response vs.  $R_F$

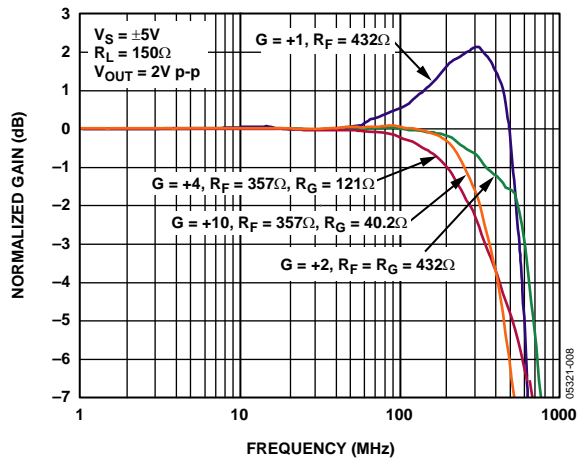

Figure 7. Large Signal Frequency Response vs. Various Gains

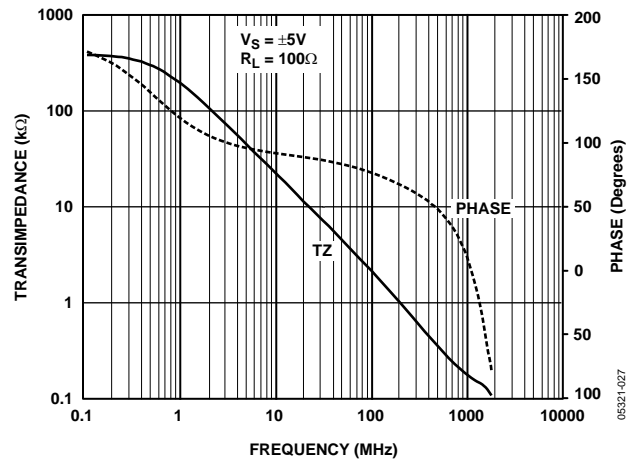

Figure 10. Transimpedance and Phase vs. Frequency

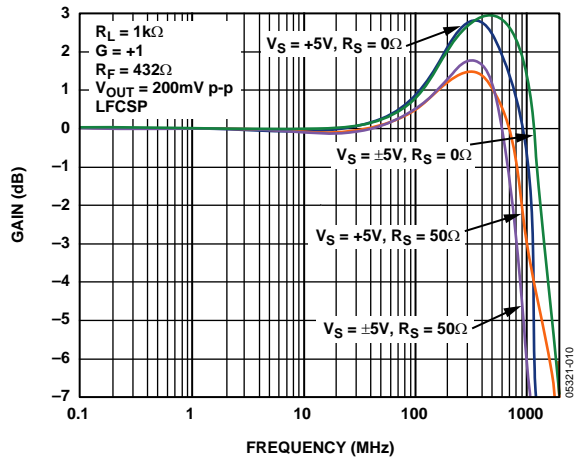

Figure 11. Small Signal Frequency Response vs. Supply Voltage

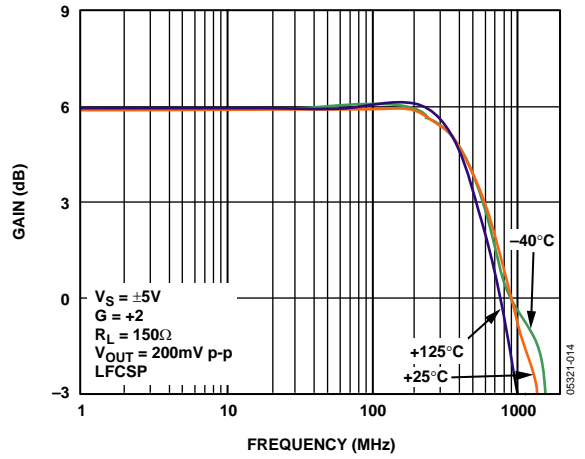

Figure 14. Small Signal Frequency Response vs. Temperature

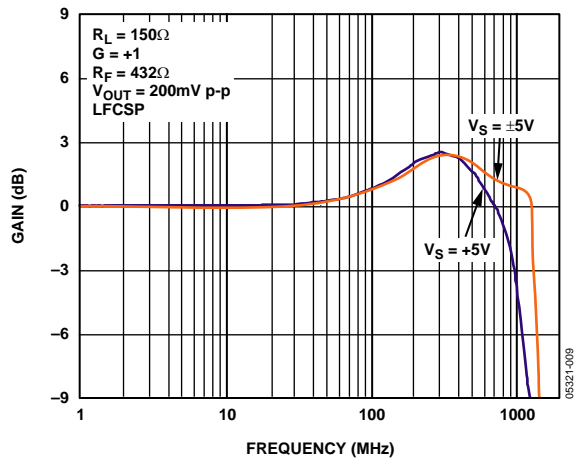

Figure 12. Small Signal Frequency Response vs. Supply Voltage

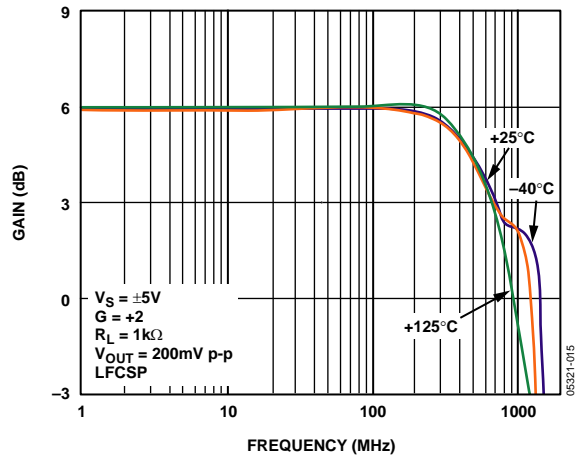

Figure 15. Small Signal Frequency Response vs. Temperature

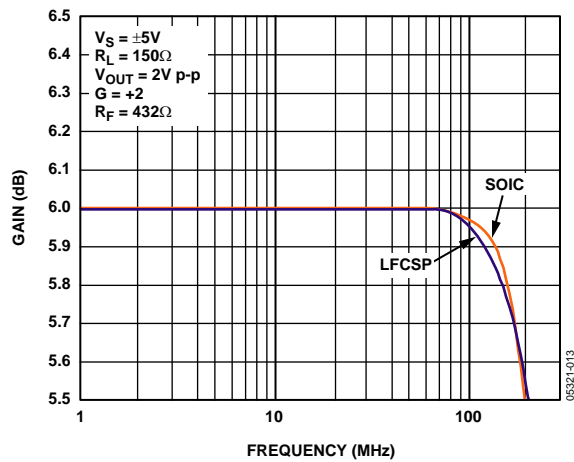

Figure 13. 0.1 dB Flatness

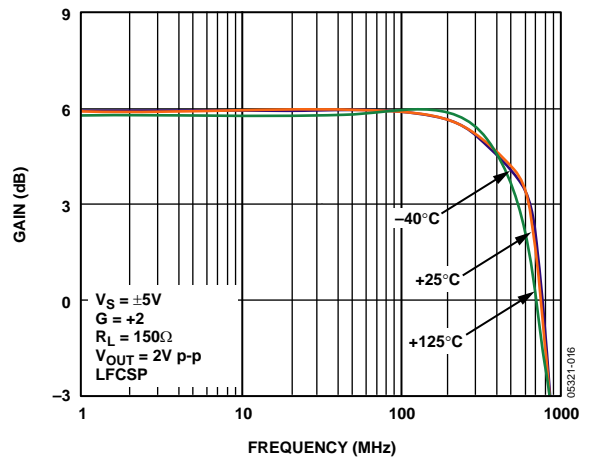

Figure 16. Large Signal Frequency Response vs. Temperature

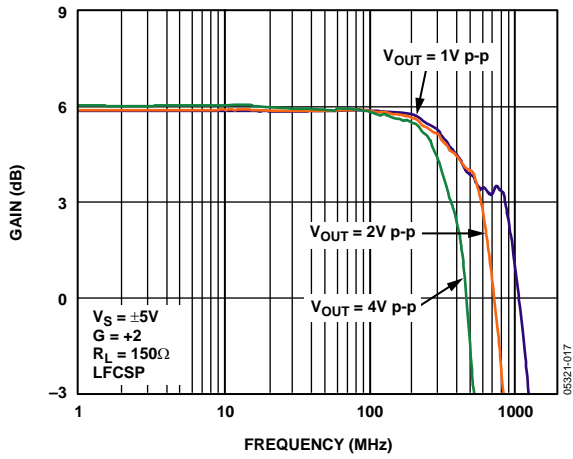

Figure 17. Large Signal Frequency Response vs. Various Outputs

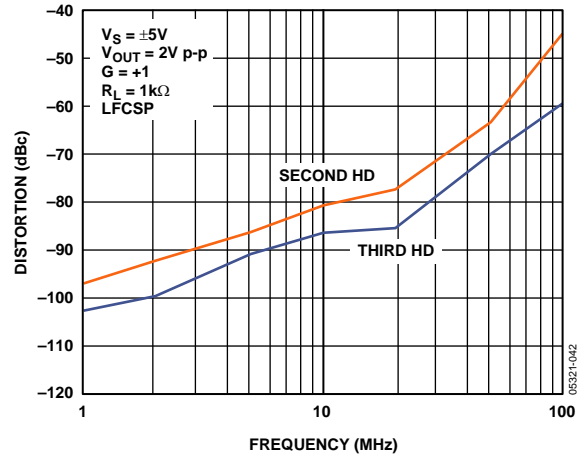

Figure 20. Harmonic Distortion vs. Frequency

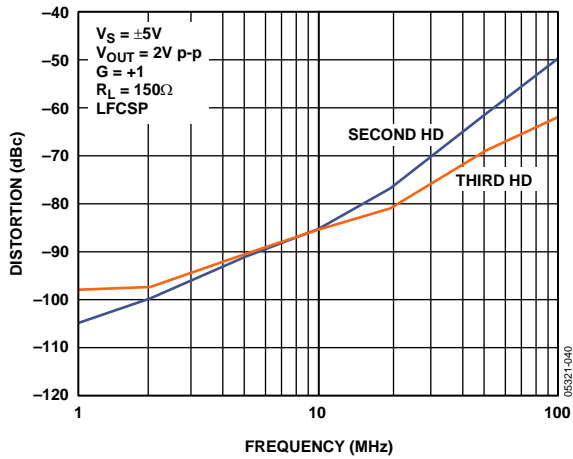

Figure 18. Harmonic Distortion vs. Frequency

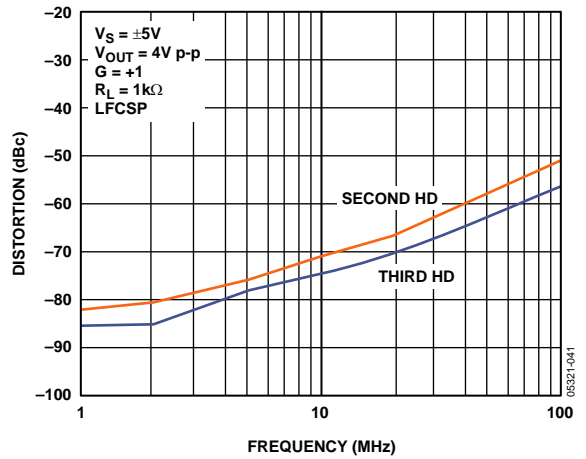

Figure 21. Harmonic Distortion vs. Frequency

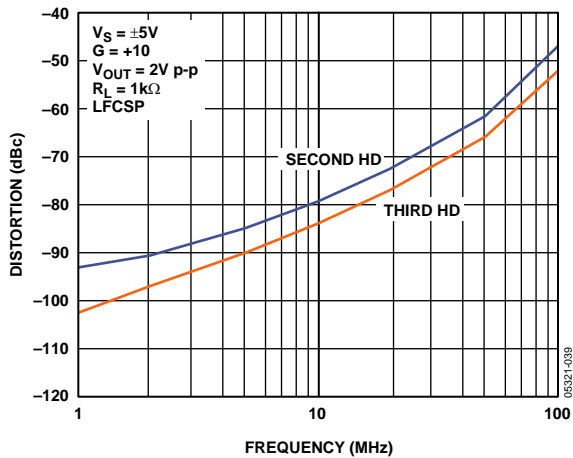

Figure 19. Harmonic Distortion vs. Frequency

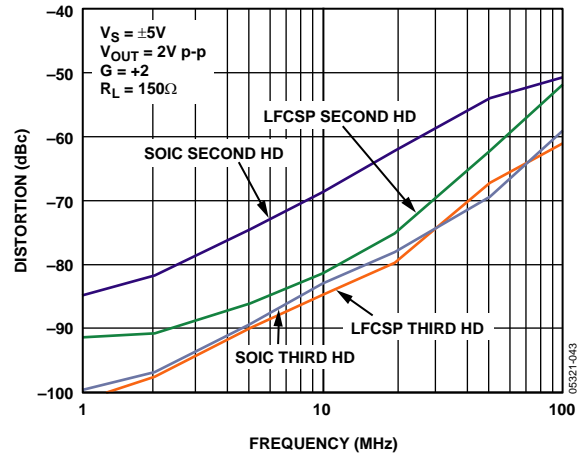

Figure 22. Harmonic Distortion vs. Frequency



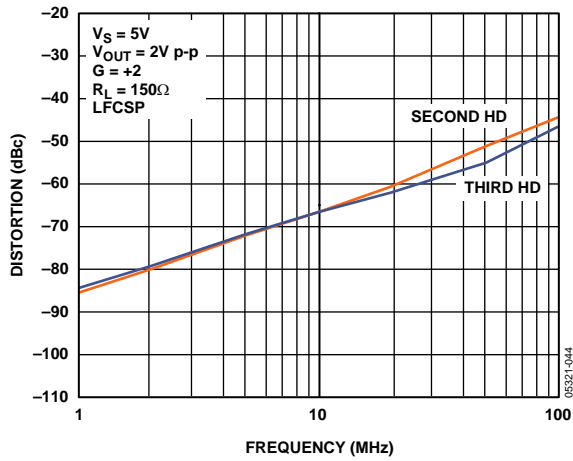

Figure 23. Harmonic Distortion vs. Frequency

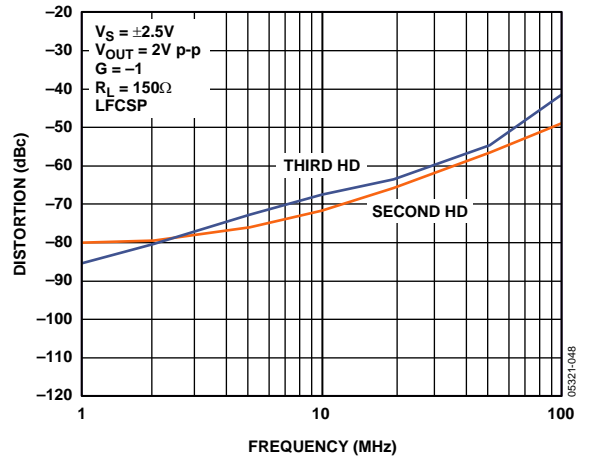

Figure 26. Harmonic Distortion vs. Frequency

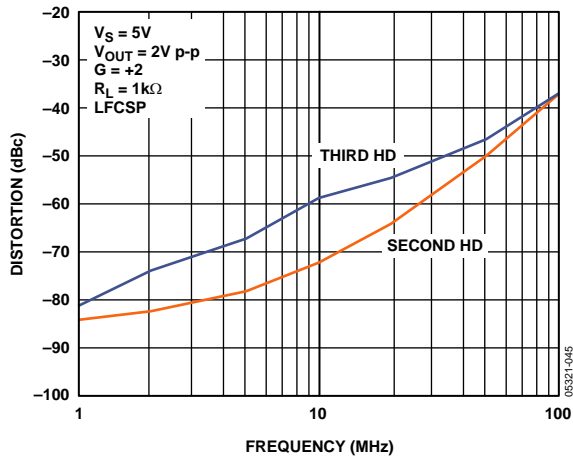

Figure 24. Harmonic Distortion vs. Frequency

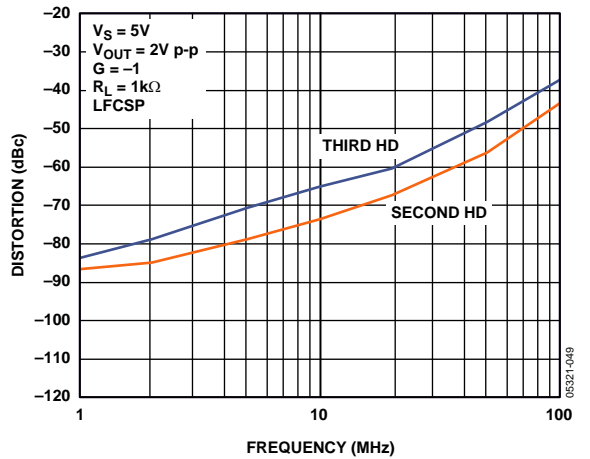

Figure 27. Harmonic Distortion vs. Frequency

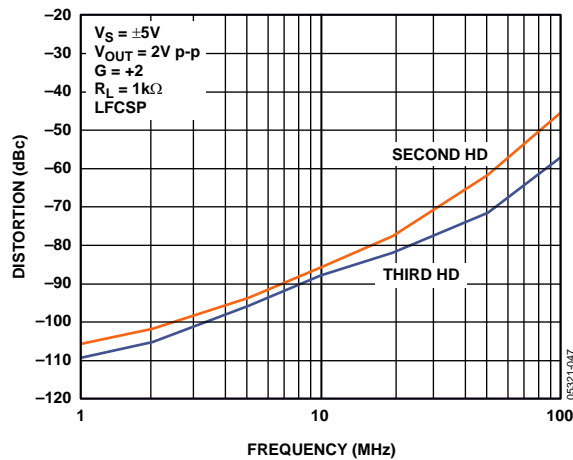

Figure 25. Harmonic Distortion vs. Frequency

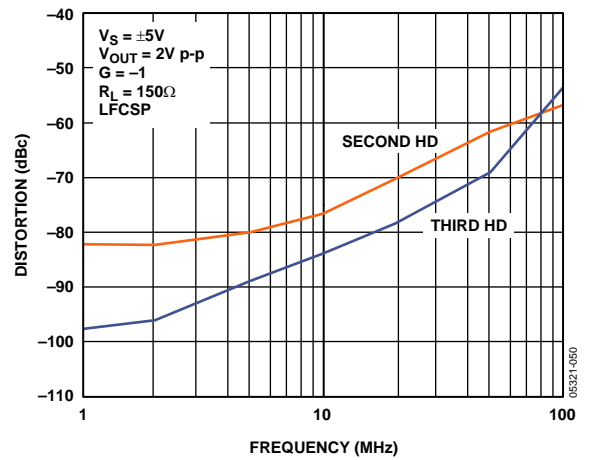

Figure 28. Harmonic Distortion vs. Frequency

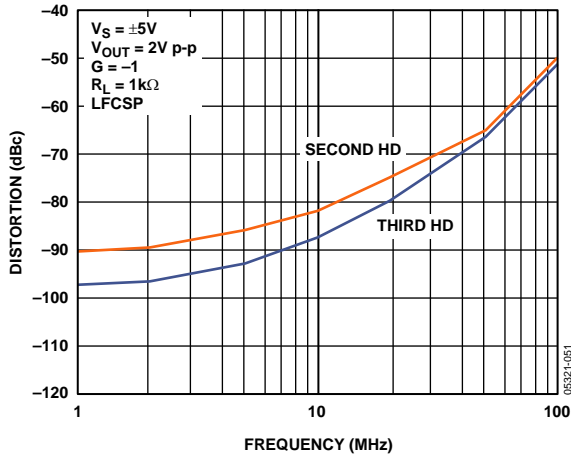

Figure 29. Harmonic Distortion vs. Frequency

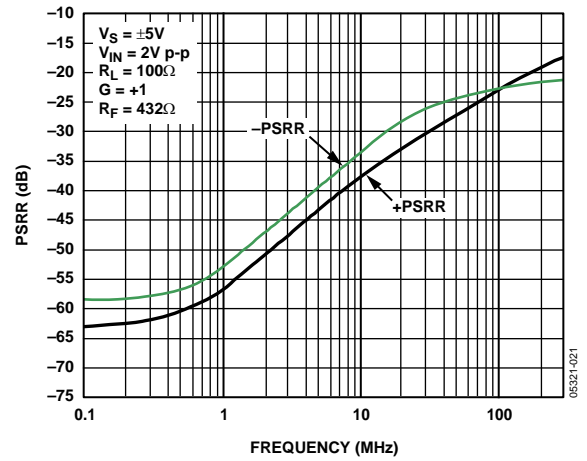

Figure 32. Power Supply Rejection Ratio (PSRR) vs. Frequency

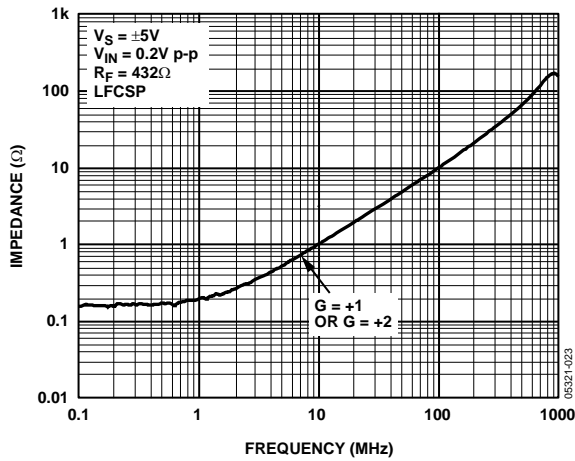

Figure 30. Output Impedance vs. Frequency

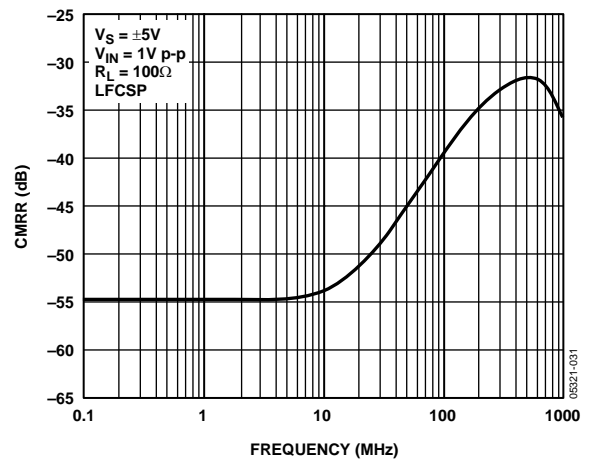

Figure 33. Common-Mode Rejection Ratio vs. Frequency

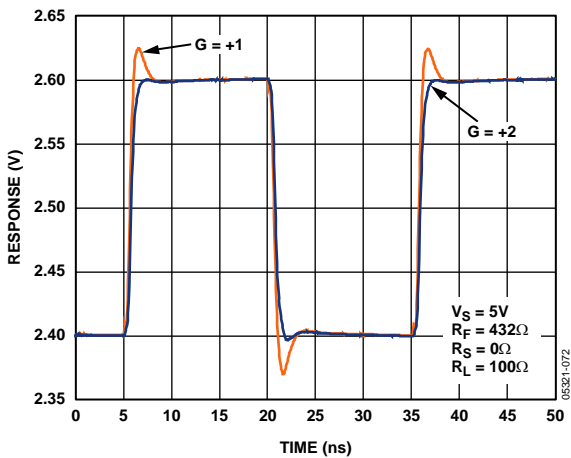

Figure 31. Small Signal Transient Response

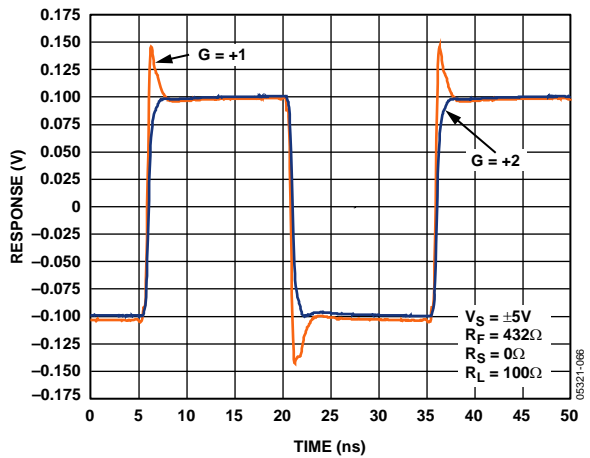

Figure 34. Small Signal Transient Response

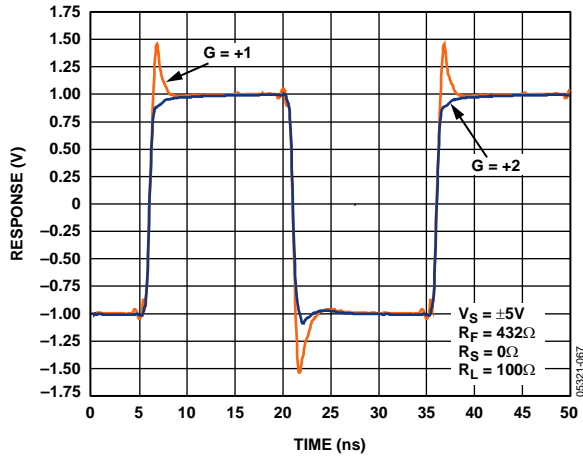

Figure 35. Large Signal Transient Response

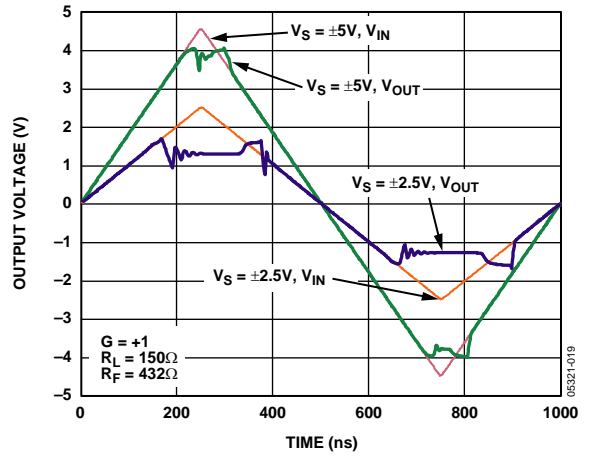

Figure 38. Input Overdrive

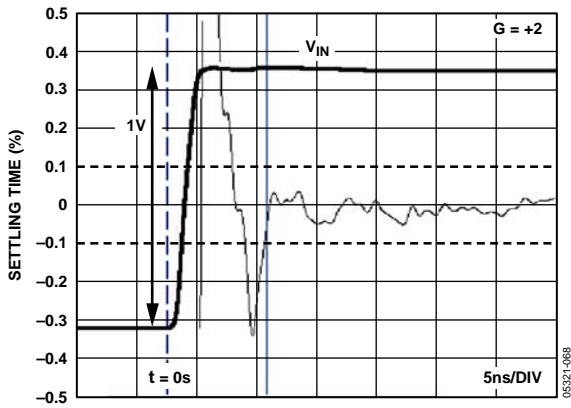

Figure 36. Settling Time

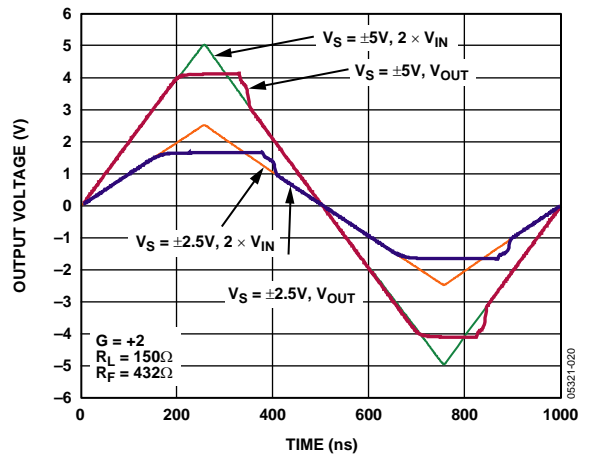

Figure 39. Output Overdrive

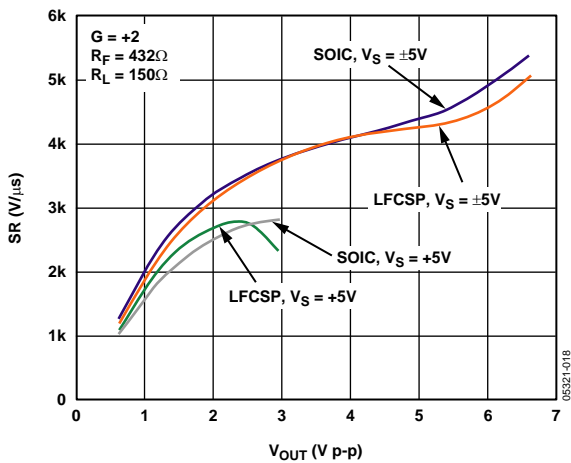

Figure 37. Slew Rate vs. Output Level

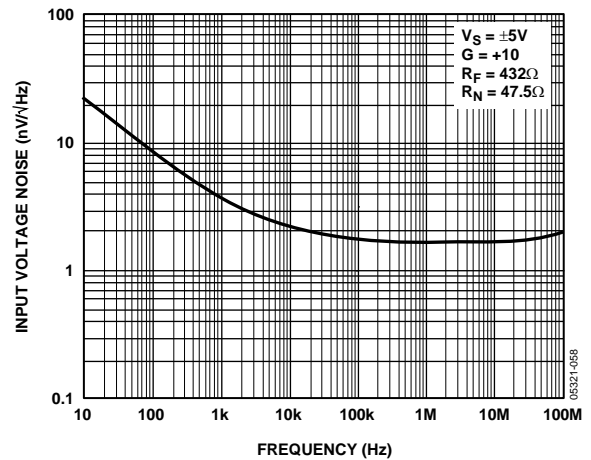

Figure 40. Input Voltage Noise

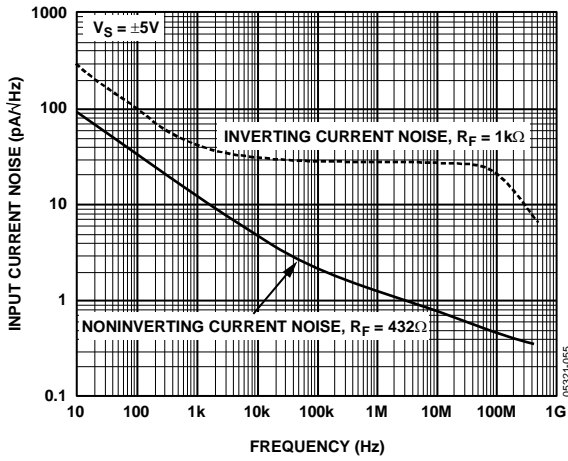

Figure 41. Input Current Noise

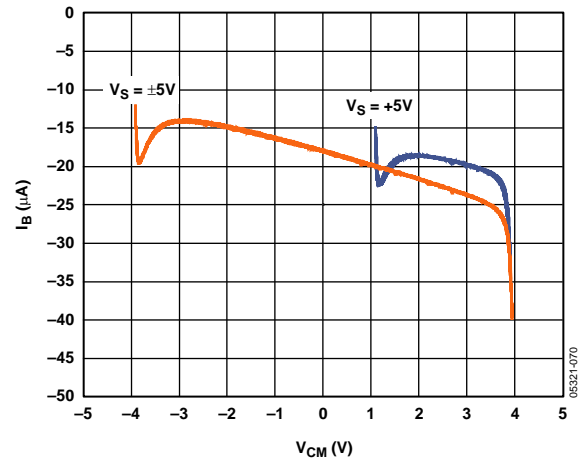

Figure 44. Input Bias Current vs. Common-Mode Voltage

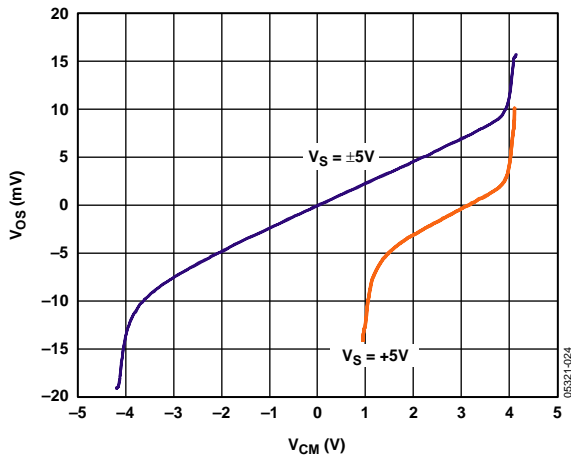

Figure 42. Input  $V_{OS}$  vs. Common-Mode Voltage

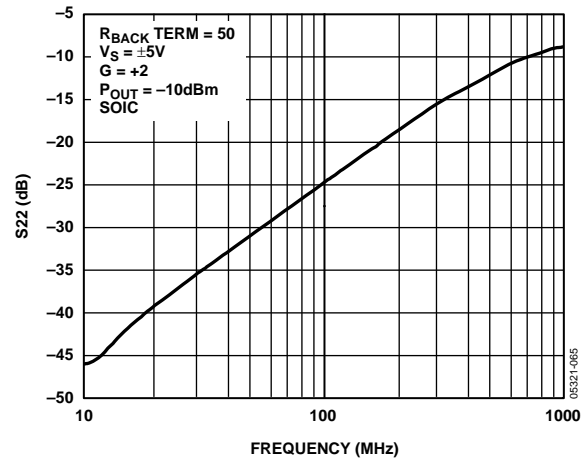

Figure 45. Output Voltage Standing Wave Ratio (S22)

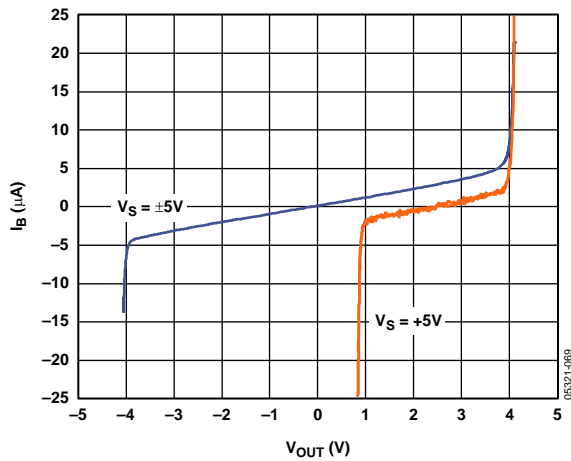

Figure 43. Input Bias Current vs. Output Voltage

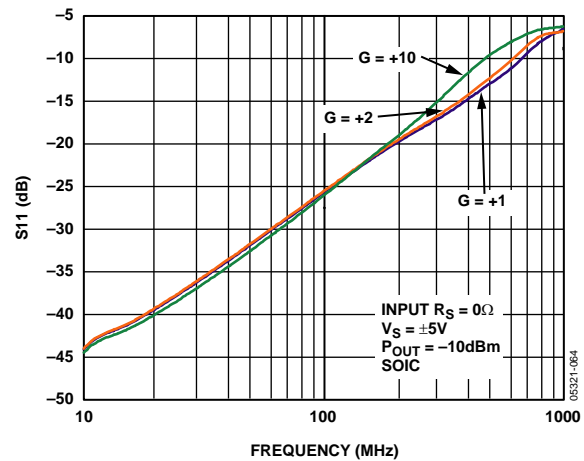

Figure 46. Input Voltage Standing Wave Ratio (S11)

TEST CIRCUITS

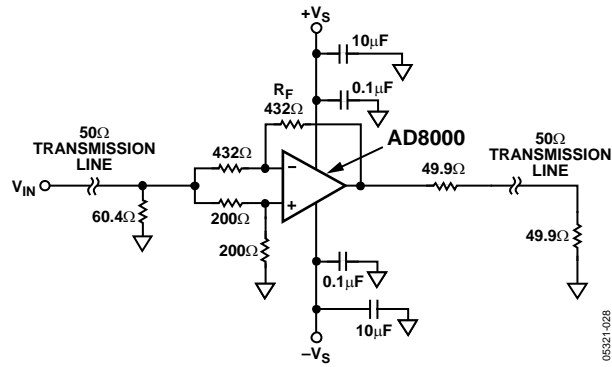

Figure 47. CMRR

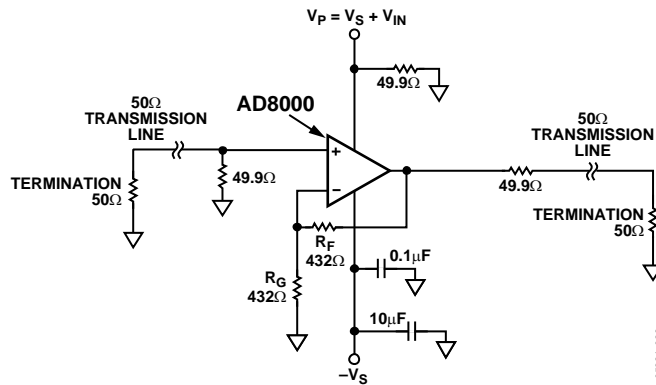

Figure 48. Positive PSRR

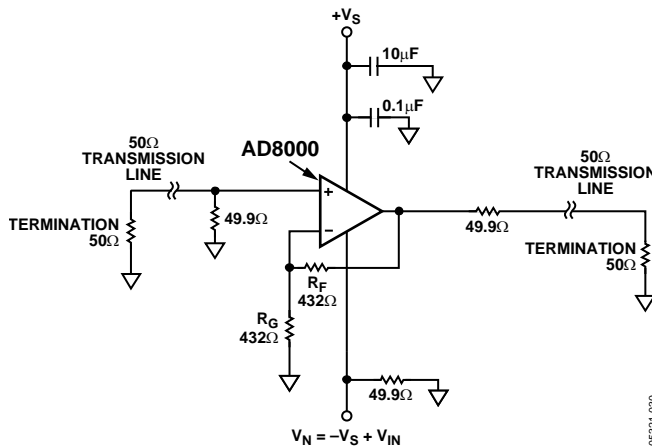

Figure 49. Negative PSRR

## APPLICATIONS INFORMATION

All current feedback amplifier operational amplifiers are affected by stray capacitance at the inverting input pin. As a practical consideration, the higher the stray capacitance on the inverting input to ground, the higher  $R_F$  needs to be to minimize peaking and ringing.

### CIRCUIT CONFIGURATIONS

Figure 50 and Figure 51 show typical schematics for noninverting and inverting configurations. For current feedback amplifiers, the value of feedback resistance determines the stability and bandwidth of the amplifier. The optimum performance values are shown in Table 5 and should not be deviated from by more than  $\pm 10\%$  to ensure stable operation. Figure 8 shows the influence varying  $R_F$  has on bandwidth. In noninverting unity-gain configurations, it is recommended that an  $R_S$  of  $50\ \Omega$  be used, as shown in Figure 50.

Table 5 provides a quick reference for the circuit values, gain, and output voltage noise.

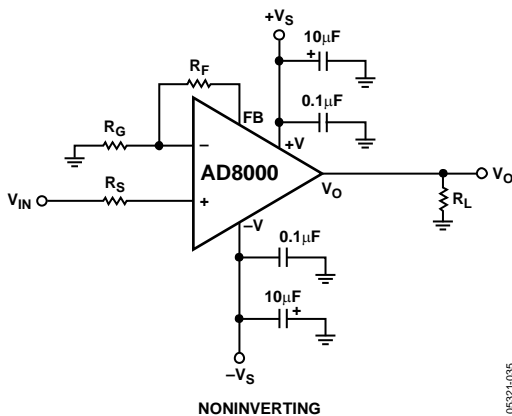

Figure 50. Noninverting Configuration

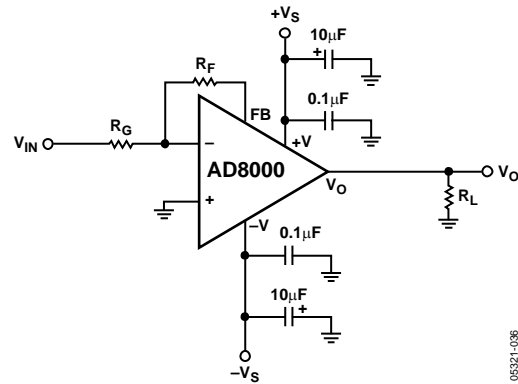

Figure 51. Inverting Configuration

### VIDEO LINE DRIVER

The AD8000 is designed to offer outstanding performance as a video line driver. The important specifications of differential gain (0.02%), differential phase ( $0.01^\circ$ ), and 650 MHz bandwidth at 2 V p-p meet the most exacting video demands. Figure 52 shows a typical noninverting video driver with a gain of +2.

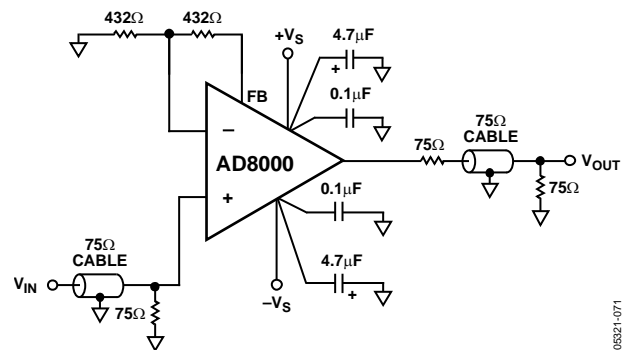

Figure 52. Video Line Driver

Table 5. Typical Values (LFCSP/SOIC)

Gain	Component Values ( $\Omega$ )		-3 dB SS Bandwidth (MHz)		-3 dB LS Bandwidth (MHz)		Slew Rate (V/ $\mu$ s)	Output Noise (nV/ $\sqrt{\text{Hz}}$ )	Total Output Noise Including Resistors (nV/ $\sqrt{\text{Hz}}$ )
	$R_F$	$R_G$	LFCSP	SOIC	LFCSP	SOIC			
1	432		1380	1580	550	600	2200	10.9	11.2
2	432	432	600	650	610	650	3700	11.3	11.9
4	357	120	550	550	350	350	3800	10	12
10	357	40	350	365	370	370	3200	18.4	19.9

## LOW DISTORTION PINOUT

The AD8000 LFCSP features Analog Devices low distortion pinout. The new pinout lowers the second harmonic distortion and simplifies the circuit layout. The close proximity of the non-inverting input and the negative supply pin creates a source of second harmonic distortion. Physical separation of the non-inverting input pin and the negative power supply pin reduces this distortion significantly, as seen in Figure 22.

By providing an additional output pin, the feedback resistor can be connected directly across Pin 2 and Pin 3. This greatly simplifies the routing of the feedback resistor and allows a more compact circuit layout, which reduces its size and helps to minimize parasitics and increase stability.

The SOIC also features a dedicated feedback pin. The feedback pin is brought out on Pin 1, which is typically a no connect on standard SOIC pinouts.

Existing applications that use the standard SOIC pinout can take full advantage of the performance offered by the AD8000. For drop-in replacements, ensure that Pin 1 is not connected to ground or to any other potential because this pin is connected internally to the output of the amplifier. For existing designs, Pin 6 can still be used for the feedback resistor.

## EXPOSED PADDLE

The AD8000 features an exposed paddle, which can lower the thermal resistance by 25% compared to a standard SOIC plastic package. The paddle can be soldered directly to the ground plane of the board. Figure 53 shows a typical pad geometry for the LFCSP, the same type of pad geometry can be applied to the SOIC package.

Thermal vias or heat pipes can also be incorporated into the design of the mounting pad for the exposed paddle. These additional vias improve the thermal transfer from the package to the PCB. Using a heavier weight copper on the surface to which the exposed paddle of the amplifier is soldered also reduces the overall thermal resistance seen by the AD8000.

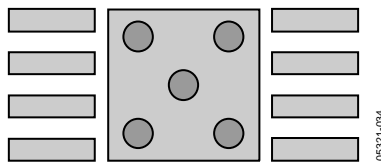

Figure 53. LFCSP Exposed Paddle Layout

## PRINTED CIRCUIT BOARD LAYOUT

Laying out the printed circuit board (PCB) is usually the last step in the design process and often proves to be one of the most critical. A brilliant design can be rendered useless because of a poor or sloppy layout. Because the AD8000 can operate into the  $R_f$  frequency spectrum, high frequency board layout considerations must be taken into account. The PCB layout, signal routing, power supply bypassing, and grounding all must be addressed to ensure optimal performance.

## SIGNAL ROUTING

The AD8000 LFCSP features the new low distortion pinout with a dedicated feedback pin and allows a compact layout. The dedicated feedback pin reduces the distance from the output to the inverting input, which greatly simplifies the routing of the feedback network.

To minimize parasitic inductances, use ground planes under high frequency signal traces. However, remove the ground plane from under the input and output pins to minimize the formation of parasitic capacitors, which degrades phase margin. Run signals that are susceptible to noise pickup on the internal layers of the PCB, which can provide maximum shielding.

## POWER SUPPLY BYPASSING

Power supply bypassing is a critical aspect of the PCB design process. For best performance, the AD8000 power supply pins need to be properly bypassed.

A parallel connection of capacitors from each of the power supply pins to ground works best. Paralleling different values and sizes of capacitors helps to ensure that the power supply pins see a low ac impedance across a wide band of frequencies. This is important for minimizing the coupling of noise into the amplifier. Starting directly at the power supply pins, place the smallest value and sized component on the same side of the board as the amplifier, and as close as possible to the amplifier, and connected to the ground plane. Repeat this process for the next larger value capacitor. It is recommended for the AD8000 that a 0.1  $\mu\text{F}$  ceramic 0508 case be used. The 0508 offers low series inductance and excellent high frequency performance. The 0.1  $\mu\text{F}$  case provides low impedance at high frequencies. Place a 10  $\mu\text{F}$  electrolytic capacitor in parallel with the 0.1  $\mu\text{F}$ . The 10  $\mu\text{F}$  capacitor provides low ac impedance at low frequencies. Smaller values of electrolytic capacitors can be used, depending on the circuit requirements. Additional smaller value capacitors help to provide a low impedance path for unwanted noise out to higher frequencies but are not always necessary.

Placement of the capacitor returns (grounds), where the capacitors enter into the ground plane, is also important. Returning the capacitors grounds close to the amplifier load is critical for distortion performance. Keeping the capacitors distance short, but equal from the load, is optimal for performance.

In some cases, bypassing between the two supplies can help to improve PSRR and to maintain distortion performance in crowded or difficult layouts. This is as another option to improve performance.

Minimizing the trace length and widening the trace from the capacitors to the amplifier reduce the trace inductance. A series inductance with the parallel capacitance can form a tank circuit, which can introduce high frequency ringing at the output. This additional inductance can also contribute to increased distortion due to high frequency compression at the output. Minimize the use of vias in the direct path to the amplifier power supply pins because vias can introduce parasitic inductance, which can lead to instability. When required, use multiple large diameter vias because this lowers the equivalent parasitic inductance.

## GROUNDING

The use of ground and power planes is encouraged as a method of providing low impedance returns for power supply and signal currents. Ground and power planes can also help to reduce stray trace inductance and to provide a low thermal path for the amplifier. Do not use ground and power planes under any of the pins of the [AD8000](#). The mounting pads and the ground or power planes can form a parasitic capacitance at the amplifiers input. Stray capacitance on the inverting input and the feedback resistor form a pole, which degrades the phase margin, leading to instability. Excessive stray capacitance on the output also forms a pole, which degrades phase margin.



OUTLINE DIMENSIONS

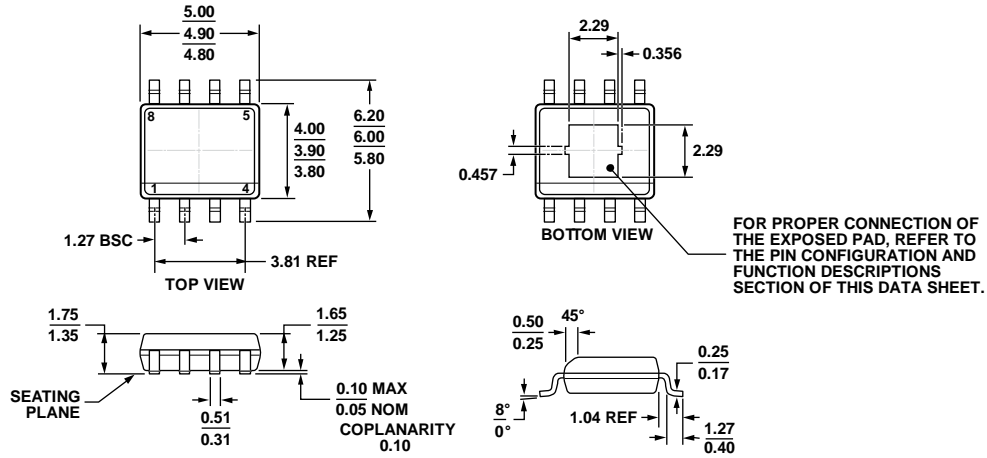

COMPLIANT TO JEDEC STANDARDS MS-012-A-A

Figure 54. 8-Lead Standard Small Outline Package, with Exposed Pad [SOIC\_N\_EP] Narrow Body (RD-8-1)  
Dimensions shown in millimeters

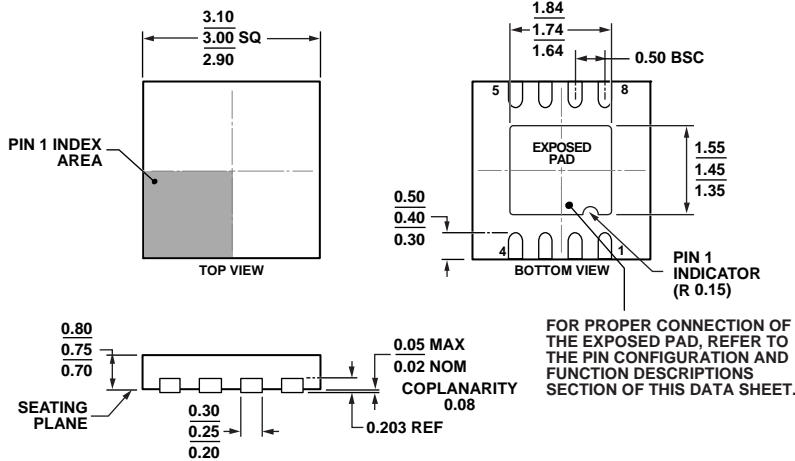

COMPLIANT TO JEDEC STANDARDS MO-229-WEED

Figure 55. 8-Lead Lead Frame Chip Scale Package [LFCSP] 3 mm x 3 mm Body and 0.75 mm Package Height (CP-8-13)  
Dimensions shown in millimeters

ORDERING GUIDE

Model <sup>1</sup>	Temperature Range	Package Description	Package Option	Branding	Ordering Quantity
AD8000YRDZ	-40°C to +125°C	8-Lead SOIC_N_EP	RD-8-1		1
AD8000YRDZ-REEL7	-40°C to +125°C	8-Lead SOIC_N_EP	RD-8-1		1,000
AD8000YCPZ-R2	-40°C to +125°C	8-Lead LFCSP	CP-8-13	HNB	250
AD8000YCPZ-REEL	-40°C to +125°C	8-Lead LFCSP	CP-8-13	HNB	5,000
AD8000YCPZ-REEL7	-40°C to +125°C	8-Lead LFCSP	CP-8-13	HNB	1,500

<sup>1</sup> Z = RoHS Compliant Part.

06-022011-B

12-07-2010-A

## X-ON Electronics

Largest Supplier of Electrical and Electronic Components

*Click to view similar products for [High Speed Operational Amplifiers](#) category:*

*Click to view products by [Analog Devices](#) manufacturer:*

Other Similar products are found below :

[NJU7047RB1-TE2](#) [LTC6226IS8#PBF](#) [LTC6226HS8#PBF](#) [LT1058ACN](#) [LT1206CR](#) [LT1058ISW](#) [THS4222DGNR](#) [OPA2677IDDAR](#)  
[THS6042ID](#) [THS4221DBVR](#) [THS4081CD](#) [ADA4858-3ACPZ-R7](#) [LT6202IS5#TRMPBF](#) [LT1206CR#PBF](#) [LTC6253CMS8#PBF](#)  
[LT1813CDD#PBF](#) [ADA4851-4YRUZ-RL](#) [LT1037IN8#PBF](#) [LTC6401CUD-20#PBF](#) [LT1192CN8#PBF](#) [LTC6401IUD-26#PBF](#)  
[LT1037ACN8#PBF](#) [LTC6253CTS8#TRMPBF](#) [LT1399HVCS#PBF](#) [LT1993CUD-2#PBF](#) [LT1722CS8#PBF](#) [LT1208CN8#PBF](#)  
[LT1222CN8#PBF](#) [LT6203IDD#PBF](#) [LT6411IUD#PBF](#) [LTC6400CUD-26#PBF](#) [LTC6400CUD-8#PBF](#) [LT6211IDD#PBF](#) [OP27EN8#PBF](#)  
[LT1810IMS8#PBF](#) [OP37EN8#PBF](#) [LTC6253IMS8#PBF](#) [LT1360CS8](#) [OPA2132PAG4](#) [OPA2353UA/2K5](#) [OPA2691I-14D](#)  
[OPA4353UA/2K5](#) [OPA690IDRG4](#) [LMH6723MFX/NOPB](#) [ADP5302ACPZ-3-R7](#) [AD8007AKSZ-REEL7](#) [AD8008ARMZ](#) [AD8009JRTZ-](#)  
[REEL7](#) [AD8010ANZ](#) [AD8014ARTZ-REEL7](#)