

FEATURES

Easy to use

Available in space-saving MSOP

Gain set with 1 external resistor (gain range 1 to 1000)

Wide power supply range: ± 2.3 V to ± 18 V

Temperature range for specified performance:

-40°C to $+85^{\circ}\text{C}$

Operational up to 125°C ¹

Excellent AC specifications

80 dB minimum CMRR to 10 kHz ($G = 1$)

825 kHz, -3 dB bandwidth ($G = 1$)

2 V/ μs slew rate

Low noise

8 nV/ $\sqrt{\text{Hz}}$, @ 1 kHz, maximum input voltage noise

0.25 μV p-p input noise (0.1 Hz to 10 Hz)

High accuracy dc performance (AD8221BR)

90 dB minimum CMRR ($G = 1$)

25 μV maximum input offset voltage

0.3 $\mu\text{V}/^{\circ}\text{C}$ maximum input offset drift

0.4 nA maximum input bias current

APPLICATIONS

Weigh scales

Industrial process controls

Bridge amplifiers

Precision data acquisition systems

Medical instrumentation

Strain gages

Transducer interfaces

GENERAL DESCRIPTION

The AD8221 is a gain programmable, high performance instrumentation amplifier that delivers the industry's highest CMRR over frequency in its class. The CMRR of instrumentation amplifiers on the market today falls off at 200 Hz. In contrast, the AD8221 maintains a minimum CMRR of 80 dB to 10 kHz for all grades at $G = 1$. High CMRR over frequency allows the AD8221 to reject wideband interference and line harmonics, greatly simplifying filter requirements. Possible applications include precision data acquisition, biomedical analysis, and aerospace instrumentation.

CONNECTION DIAGRAM

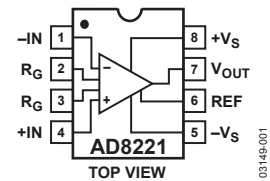

Figure 1.

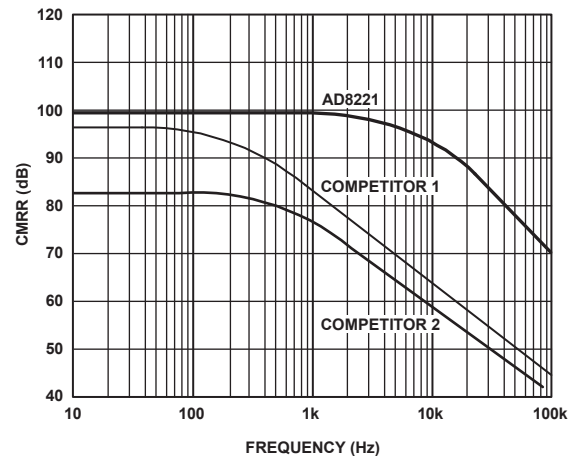

Figure 2. Typical CMRR vs. Frequency for $G = 1$

Low voltage offset, low offset drift, low gain drift, high gain accuracy, and high CMRR make this part an excellent choice in applications that demand the best dc performance possible, such as bridge signal conditioning.

Programmable gain affords the user design flexibility. A single resistor sets the gain from 1 to 1000. The AD8221 operates on both single and dual supplies and is well suited for applications where ± 10 V input voltages are encountered.

The AD8221 is available in a low cost 8-lead SOIC and 8-lead MSOP, both of which offer the industry's best performance. The MSOP requires half the board space of the SOIC, making it ideal for multichannel or space-constrained applications.

Performance is specified over the entire industrial temperature range of -40°C to $+85^{\circ}\text{C}$ for all grades. Furthermore, the AD8221 is operational from -40°C to $+125^{\circ}\text{C}$ ¹.

¹ See Typical Performance Characteristics for expected operation from 85°C to 125°C .

Rev. C

Information furnished by Analog Devices is believed to be accurate and reliable. However, no responsibility is assumed by Analog Devices for its use, nor for any infringements of patents or other rights of third parties that may result from its use. Specifications subject to change without notice. No license is granted by implication or otherwise under any patent or patent rights of Analog Devices. Trademarks and registered trademarks are the property of their respective owners.

TABLE OF CONTENTS

Features	1	Layout	18
Applications.....	1	Reference Terminal	19
General Description	1	Power Supply Regulation and Bypassing	19
Connection Diagram	1	Input Bias Current Return Path	19
Revision History	2	Input Protection	19
Specifications.....	3	RF Interference	20
Absolute Maximum Ratings.....	8	Precision Strain Gage.....	20
Thermal Characteristics	8	Conditioning ± 10 V Signals for a +5 V Differential Input	
ESD Caution.....	8	ADC	20
Pin Configuration and Function Descriptions.....	9	AC-Coupled Instrumentation Amplifier	21
Typical Performance Characteristics	10	Die Information	22
Theory of Operation	17	Outline Dimensions	23
Gain Selection	18	Ordering Guide	24

REVISION HISTORY

3/11—Rev. B to Rev. C

Added Pin Configuration and Function Descriptions Section ..	9
Added Die Information Section	22
Updated Outline Dimensions	23
Changes to Ordering Guide	24

9/07—Rev. A to Rev. B

Changes to Features.....	1
Changes to Table 1 Layout.....	3
Changes to Table 2 Layout.....	5
Changes to Figure 15.....	11
Changes to Figures 32	13
Changes to Figure 33, Figure 34, and Figure 35	14
Updated Outline Dimensions	21
Changes to Ordering Guide	22

11/03—Rev. 0 to Rev. A

Changes to Features.....	1
Changes to Specifications Section	4
Changes to Theory of Operation Section.....	13
Changes to Gain Selection Section.....	14

10/03—Revision 0: Initial Version

SPECIFICATIONS

$V_S = \pm 15\text{ V}$, $V_{REF} = 0\text{ V}$, $T_A = 25^\circ\text{C}$, $G = 1$, $R_L = 2\text{ k}\Omega$, unless otherwise noted.

Table 1.

Parameter	Conditions	AR Grade			BR Grade			Unit
		Min	Typ	Max	Min	Typ	Max	
COMMON-MODE REJECTION RATIO								
CMRR DC to 60 Hz with 1 k Ω Source Imbalance	$V_{CM} = -10\text{ V to }+10\text{ V}$							
G = 1		80			90			dB
G = 10		100			110			dB
G = 100		120			130			dB
G = 1000		130			140			dB
CMRR at 10 kHz	$V_{CM} = -10\text{ V to }+10\text{ V}$							
G = 1		80			80			dB
G = 10		90			100			dB
G = 100		100			110			dB
G = 1000		100			110			dB
NOISE	RTI noise = $\sqrt{e_{NI}^2 + (e_{NO}/G)^2}$							
Voltage Noise, 1 kHz								
Input Voltage Noise, e_{NI}	$V_{IN+}, V_{IN-}, V_{REF} = 0$			8			8	nV/ $\sqrt{\text{Hz}}$
Output Voltage Noise, e_{NO}				75			75	nV/ $\sqrt{\text{Hz}}$
RTI	$f = 0.1\text{ Hz to }10\text{ Hz}$							
G = 1			2			2		$\mu\text{V p-p}$
G = 10			0.5			0.5		$\mu\text{V p-p}$
G = 100 to 1000			0.25			0.25		$\mu\text{V p-p}$
Current Noise	$f = 1\text{ kHz}$ $f = 0.1\text{ Hz to }10\text{ Hz}$		40			40		fA/ $\sqrt{\text{Hz}}$
			6			6		pA p-p
VOLTAGE OFFSET ¹								
Input Offset, V_{OSI}	$V_S = \pm 5\text{ V to } \pm 15\text{ V}$			60			25	μV
Over Temperature	$T = -40^\circ\text{C to }+85^\circ\text{C}$			86			45	μV
Average TC				0.4			0.3	$\mu\text{V}/^\circ\text{C}$
Output Offset, V_{OSO}	$V_S = \pm 5\text{ V to } \pm 15\text{ V}$			300			200	μV
Over Temperature	$T = -40^\circ\text{C to }+85^\circ\text{C}$			0.66			0.45	mV
Average TC				6			5	$\mu\text{V}/^\circ\text{C}$
Offset RTI vs. Supply (PSR)	$V_S = \pm 2.3\text{ V to } \pm 18\text{ V}$							
G = 1		90	110		94	110		dB
G = 10		110	120		114	130		dB
G = 100		124	130		130	140		dB
G = 1000		130	140		140	150		dB
INPUT CURRENT								
Input Bias Current			0.5	1.5		0.2	0.4	nA
Over Temperature	$T = -40^\circ\text{C to }+85^\circ\text{C}$			2.0			1	nA
Average TC			1			1		pA/ $^\circ\text{C}$
Input Offset Current			0.2	0.6		0.1	0.4	nA
Over Temperature	$T = -40^\circ\text{C to }+85^\circ\text{C}$			0.8			0.6	nA
Average TC			1			1		pA/ $^\circ\text{C}$
REFERENCE INPUT								
R_{IN}			20			20		k Ω
I_{IN}	$V_{IN+}, V_{IN-}, V_{REF} = 0$		50	60		50	60	μA
Voltage Range		$-V_S$		$+V_S$	$-V_S$		$+V_S$	V
Gain to Output			1 ± 0.0001			1 ± 0.0001		V/V

AD8221

Parameter	Conditions	AR Grade			BR Grade			Unit
		Min	Typ	Max	Min	Typ	Max	
POWER SUPPLY								
Operating Range	$V_S = \pm 2.3 \text{ V to } \pm 18 \text{ V}$	± 2.3		± 18	± 2.3		± 18	V
Quiescent Current			0.9	1		0.9	1	mA
Over Temperature	$T = -40^\circ\text{C to } +85^\circ\text{C}$		1	1.2		1	1.2	mA
DYNAMIC RESPONSE								
Small Signal –3 dB Bandwidth								
G = 1			825			825		kHz
G = 10			562			562		kHz
G = 100			100			100		kHz
G = 1000			14.7			14.7		kHz
Settling Time 0.01%	10 V step							
G = 1 to 100			10			10		μs
G = 1000			80			80		μs
Settling Time 0.001%	10 V step							
G = 1 to 100			13			13		μs
G = 1000			110			110		μs
Slew Rate	G = 1	1.5	2		1.5	2		V/ μs
	G = 5 to 100	2	2.5		2	2.5		V/ μs
GAIN								
Gain Range	$G = 1 + (49.4 \text{ k}\Omega/R_G)$	1		1000	1		1000	V/V
Gain Error	$V_{\text{OUT}} \pm 10 \text{ V}$							
G = 1				0.03			0.02	%
G = 10				0.3			0.15	%
G = 100				0.3			0.15	%
G = 1000				0.3			0.15	%
Gain Nonlinearity	$V_{\text{OUT}} = -10 \text{ V to } +10 \text{ V}$							
G = 1 to 10	$R_L = 10 \text{ k}\Omega$		3	10		3	10	ppm
G = 100	$R_L = 10 \text{ k}\Omega$		5	15		5	15	ppm
G = 1000	$R_L = 10 \text{ k}\Omega$		10	40		10	40	ppm
G = 1 to 100	$R_L = 2 \text{ k}\Omega$		10	95		10	95	ppm
Gain vs. Temperature								
G = 1			3	10		2	5	ppm/ $^\circ\text{C}$
G > 1 ²				-50			-50	ppm/ $^\circ\text{C}$
INPUT								
Input Impedance								
Differential			100 2			100 2		$\text{G}\Omega \text{pF}$
Common Mode			100 2			100 2		$\text{G}\Omega \text{pF}$
Input Operating Voltage Range ³	$V_S = \pm 2.3 \text{ V to } \pm 5 \text{ V}$	$-V_S + 1.9$		$+V_S - 1.1$	$-V_S + 1.9$		$+V_S - 1.1$	V
Over Temperature	$T = -40^\circ\text{C to } +85^\circ\text{C}$	$-V_S + 2.0$		$+V_S - 1.2$	$-V_S + 2.0$		$+V_S - 1.2$	V
Input Operating Voltage Range	$V_S = \pm 5 \text{ V to } \pm 18 \text{ V}$	$-V_S + 1.9$		$+V_S - 1.2$	$-V_S + 1.9$		$+V_S - 1.2$	V
Over Temperature	$T = -40^\circ\text{C to } +85^\circ\text{C}$	$-V_S + 2.0$		$+V_S - 1.2$	$-V_S + 2.0$		$+V_S - 1.2$	V
OUTPUT								
Output Swing	$R_L = 10 \text{ k}\Omega$							
Over Temperature	$V_S = \pm 2.3 \text{ V to } \pm 5 \text{ V}$	$-V_S + 1.1$		$+V_S - 1.2$	$-V_S + 1.1$		$+V_S - 1.2$	V
Over Temperature	$T = -40^\circ\text{C to } +85^\circ\text{C}$	$-V_S + 1.4$		$+V_S - 1.3$	$-V_S + 1.4$		$+V_S - 1.3$	V
Output Swing	$V_S = \pm 5 \text{ V to } \pm 18 \text{ V}$	$-V_S + 1.2$		$+V_S - 1.4$	$-V_S + 1.2$		$+V_S - 1.4$	V
Over Temperature	$T = -40^\circ\text{C to } +85^\circ\text{C}$	$-V_S + 1.6$		$+V_S - 1.5$	$-V_S + 1.6$		$+V_S - 1.5$	V
Short-Circuit Current			18			18		mA

Parameter	Conditions	AR Grade		BR Grade		Unit		
		Min	Typ	Max	Min		Typ	Max
TEMPERATURE RANGE								
Specified Performance		-40		+85	-40		+85	°C
Operating Range ⁴		-40		+125	-40		+125	°C

¹ Total RTI $V_{OS} = (V_{OSI}) + (V_{OSO}/G)$.

² Does not include the effects of external resistor R_G .

³ One input grounded. $G = 1$.

⁴ See Typical Performance Characteristics for expected operation between 85°C to 125°C.

Table 2.

Parameter	Conditions	ARM Grade		Unit
		Min	Typ	
COMMON-MODE REJECTION RATIO (CMRR)				
CMRR DC to 60 Hz with 1 k Ω Source Imbalance	$V_{CM} = -10V$ to $+10V$			
$G = 1$		80		dB
$G = 10$		100		dB
$G = 100$		120		dB
$G = 1000$		130		dB
CMRR at 10 kHz	$V_{CM} = -10V$ to $+10V$			
$G = 1$		80		dB
$G = 10$		90		dB
$G = 100$		100		dB
$G = 1000$		100		dB
NOISE				
Voltage Noise, 1 kHz	RTI noise = $\sqrt{e_{NI}^2 + (e_{NO}/G)^2}$			
Input Voltage Noise, e_{NI}	$V_{IN+}, V_{IN-}, V_{REF} = 0$			8
Output Voltage Noise, e_{NO}				75
RTI	$f = 0.1$ Hz to 10 Hz			
$G = 1$			2	μV p-p
$G = 10$			0.5	μV p-p
$G = 100$ to 1000			0.25	μV p-p
Current Noise	$f = 1$ kHz		40	fA/ \sqrt{Hz}
	$f = 0.1$ Hz to 10 Hz		6	pA p-p
VOLTAGE OFFSET ¹				
Input Offset, V_{OSI}	$V_S = \pm 5V$ to $\pm 15V$			70
Over Temperature	$T = -40^\circ C$ to $+85^\circ C$			135
Average TC				0.9
Output Offset, V_{OSO}	$V_S = \pm 5V$ to $\pm 15V$			600
Over Temperature	$T = -40^\circ C$ to $+85^\circ C$			1.00
Average TC				9
Offset RTI vs. Supply (PSR)	$V_S = \pm 2.3V$ to $\pm 18V$			
$G = 1$		90	100	dB
$G = 10$		100	120	dB
$G = 100$		120	140	dB
$G = 1000$		120	140	dB
INPUT CURRENT				
Input Bias Current			0.5	2
Over Temperature	$T = -40^\circ C$ to $+85^\circ C$			3
Average TC			3	pA/ $^\circ C$
Input Offset Current			0.3	1
Over Temperature	$T = -40^\circ C$ to $+85^\circ C$			1.5
Average TC			3	pA/ $^\circ C$

AD8221

Parameter	Conditions	ARM Grade			Unit
		Min	Typ	Max	
REFERENCE INPUT					
R_{IN}	$V_{IN+}, V_{IN-}, V_{REF} = 0$		20		k Ω
I_{IN}			50	60	μ A
Voltage Range		$-V_S$		$+V_S$	V
Gain to Output				1 ± 0.0001	V/V
POWER SUPPLY					
Operating Range	$V_S = \pm 2.3 \text{ V to } \pm 18 \text{ V}$	± 2.3		± 18	V
Quiescent Current	$T = -40^\circ\text{C to } +85^\circ\text{C}$		0.9	1	mA
Over Temperature			1	1.2	mA
DYNAMIC RESPONSE					
Small Signal –3 dB Bandwidth					
$G = 1$			825		kHz
$G = 10$			562		kHz
$G = 100$			100		kHz
$G = 1000$			14.7		kHz
Settling Time 0.01%					
$G = 1$ to 100	10 V step		10		μ s
$G = 1000$			80		μ s
Settling Time 0.001%					
$G = 1$ to 100	10 V step		13		μ s
$G = 1000$			110		μ s
Slew Rate					
$G = 1$	$G = 1$	1.5	2		V/ μ s
$G = 5$ to 100	$G = 5$ to 100	2	2.5		V/ μ s
GAIN					
Gain Range	$G = 1 + (49.4 \text{ k}\Omega/R_G)$	1		1000	V/V
Gain Error					
$G = 1$	$V_{OUT} \pm 10 \text{ V}$			0.1	%
$G = 10$				0.3	%
$G = 100$				0.3	%
$G = 1000$				0.3	%
Gain Nonlinearity					
$G = 1$ to 10	$V_{OUT} = -10 \text{ V to } +10 \text{ V}$		5	15	ppm
$G = 100$	$R_L = 10 \text{ k}\Omega$		7	20	ppm
$G = 1000$	$R_L = 10 \text{ k}\Omega$		10	50	ppm
$G = 1$ to 100	$R_L = 2 \text{ k}\Omega$		15	100	ppm
Gain vs. Temperature					
$G = 1$			3	10	ppm/ $^\circ\text{C}$
$G > 1^2$				-50	ppm/ $^\circ\text{C}$
INPUT					
Input Impedance					
Differential			100 2		G Ω /pF
Common Mode			100 2		G Ω /pF
Input Operating Voltage Range ³					
Over Temperature	$V_S = \pm 2.3 \text{ V to } \pm 5 \text{ V}$	$-V_S + 1.9$		$+V_S - 1.1$	V
	$T = -40^\circ\text{C to } +85^\circ\text{C}$	$-V_S + 2.0$		$+V_S - 1.2$	V
Input Operating Voltage Range					
Over Temperature	$V_S = \pm 5 \text{ V to } \pm 18 \text{ V}$	$-V_S + 1.9$		$+V_S - 1.2$	V
	$T = -40^\circ\text{C to } +85^\circ\text{C}$	$-V_S + 2.0$		$+V_S - 1.2$	V
OUTPUT					
$R_L = 10 \text{ k}\Omega$					
Output Swing					
Over Temperature	$V_S = \pm 2.3 \text{ V to } \pm 5 \text{ V}$	$-V_S + 1.1$		$+V_S - 1.2$	V
	$T = -40^\circ\text{C to } +85^\circ\text{C}$	$-V_S + 1.4$		$+V_S - 1.3$	V
Output Swing					
Over Temperature	$V_S = \pm 5 \text{ V to } \pm 18 \text{ V}$	$-V_S + 1.2$		$+V_S - 1.4$	V
	$T = -40^\circ\text{C to } +85^\circ\text{C}$	$-V_S + 1.6$		$+V_S - 1.5$	V
Short-Circuit Current			18		mA

Parameter	Conditions	ARM Grade			Unit
		Min	Typ	Max	
TEMPERATURE RANGE					
Specified Performance		-40		+85	°C
Operating Range ⁴		-40		+125	°C

¹ Total RTI $V_{OS} = (V_{OSI}) + (V_{OSO}/G)$.

² Does not include the effects of external resistor R_G .

³ One input grounded. $G = 1$.

⁴ See Typical Performance Characteristics for expected operation between 85°C to 125°C.

ABSOLUTE MAXIMUM RATINGS

Table 3.

Parameter	Rating
Supply Voltage	±18 V
Internal Power Dissipation	200 mW
Output Short-Circuit Current	Indefinite
Input Voltage (Common-Mode)	±V _S
Differential Input Voltage	±V _S
Storage Temperature Range	−65°C to +150°C
Operating Temperature Range ¹	−40°C to +125°C

¹ Temperature range for specified performance is −40°C to +85°C. See Typical Performance Characteristics for expected operation from 85°C to 125°C.

Stresses above those listed under Absolute Maximum Ratings may cause permanent damage to the device. This is a stress rating only; functional operation of the device at these or any other conditions above those indicated in the operational section of this specification is not implied. Exposure to absolute maximum rating conditions for extended periods may affect device reliability.

THERMAL CHARACTERISTICS

Specification for a device in free air.

Table 4.

Package	θ _{JA}	Unit
8-Lead SOIC, 4-Layer JEDEC Board	121	°C/W
8-Lead MSOP, 4-Layer JEDEC Board	135	°C/W

ESD CAUTION



ESD (electrostatic discharge) sensitive device. Charged devices and circuit boards can discharge without detection. Although this product features patented or proprietary protection circuitry, damage may occur on devices subjected to high energy ESD. Therefore, proper ESD precautions should be taken to avoid performance degradation or loss of functionality.

PIN CONFIGURATION AND FUNCTION DESCRIPTIONS

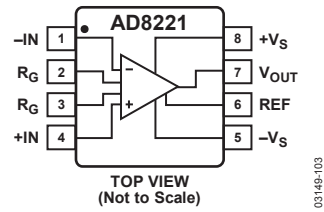

Figure 3. Pin Configuration

Table 5. Pin Function Descriptions

Pin No.	Mnemonic	Description
1	-IN	Negative Input Terminal.
2	R_G	Gain Setting Terminal. Place resistor across the R_G pins to set the gain. $G = 1 + (49.4 \text{ k}\Omega/R_G)$.
3	R_G	Gain Setting Terminal. Place resistor across the R_G pins to set the gain. $G = 1 + (49.4 \text{ k}\Omega/R_G)$.
4	+IN	Positive Input Terminal.
5	$-V_S$	Negative Power Supply Terminal.
6	REF	Reference Voltage Terminal. Drive this terminal with a low impedance voltage source to level-shift the output.
7	V_{OUT}	Output Terminal.
8	$+V_S$	Positive Power Supply Terminal.

TYPICAL PERFORMANCE CHARACTERISTICS

T = 25°C, $V_S = \pm 15\text{ V}$, $R_L = 10\text{ k}\Omega$, unless otherwise noted.

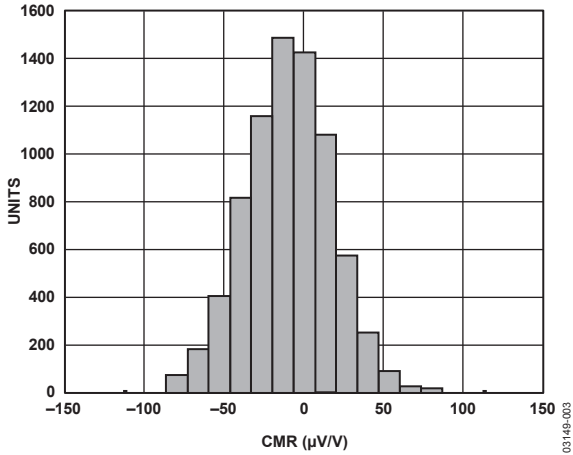

Figure 4. Typical Distribution for CMR ($G = 1$)

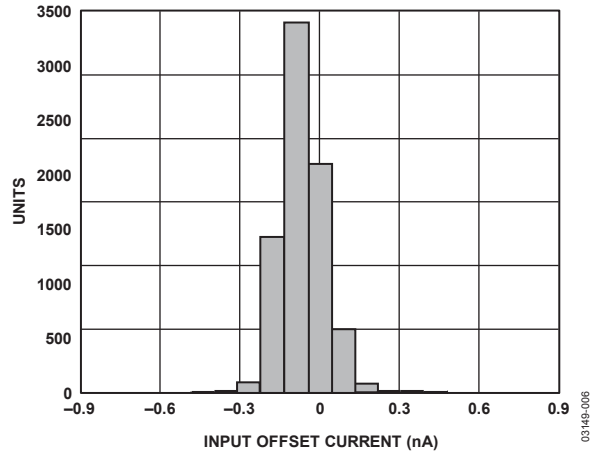

Figure 7. Typical Distribution of Input Offset Current

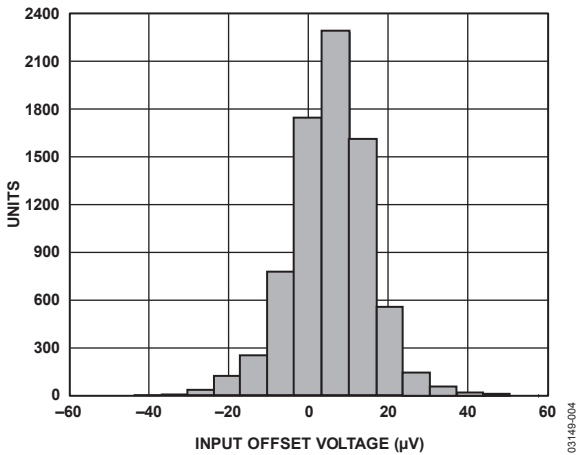

Figure 5. Typical Distribution of Input Offset Voltage

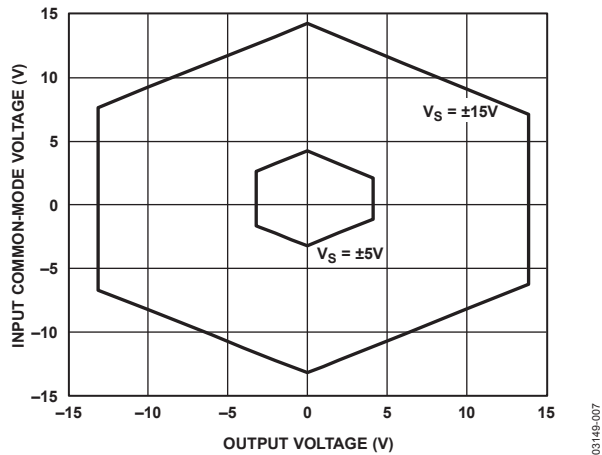

Figure 8. Input Common-Mode Range vs. Output Voltage, $G = 1$

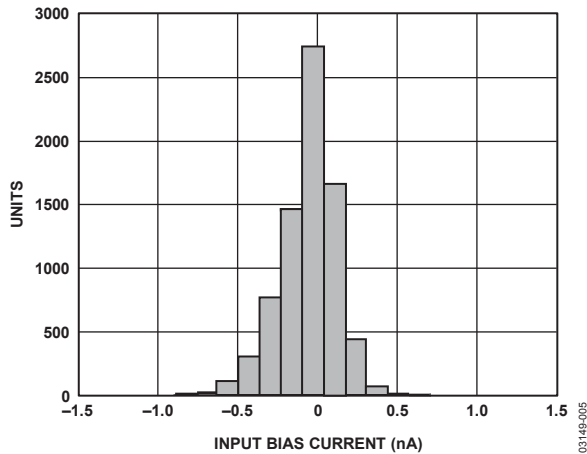

Figure 6. Typical Distribution of Input Bias Current

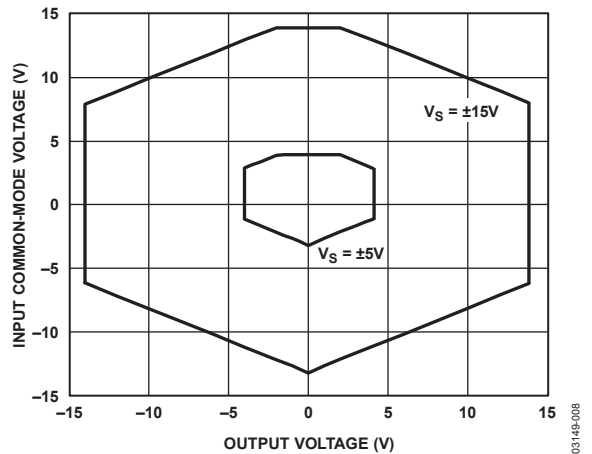

Figure 9. Input Common-Mode Range vs. Output Voltage, $G = 100$

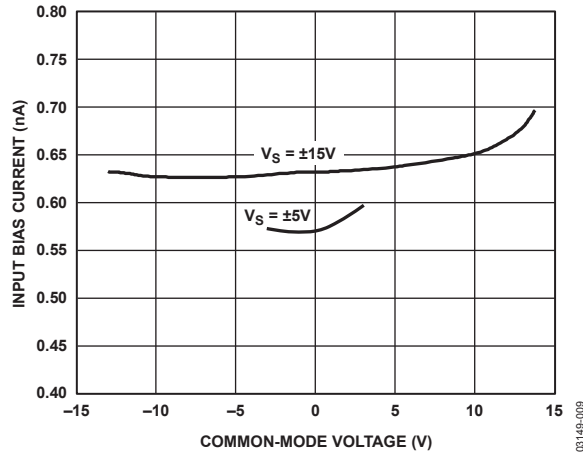

Figure 10. I_{BIAS} vs. CMV

03149-009

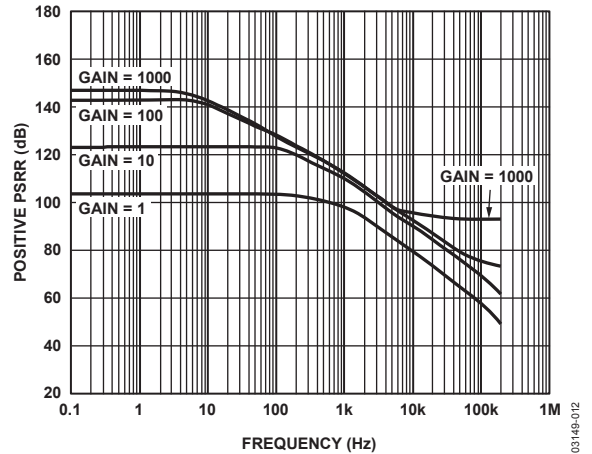

Figure 13. Positive PSRR vs. Frequency, RTI ($G = 1$ to 1000)

03149-012

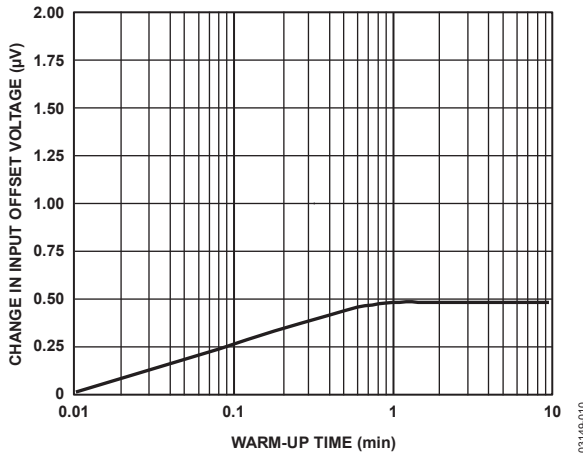

Figure 11. Change in Input Offset Voltage vs. Warm-Up Time

03149-010

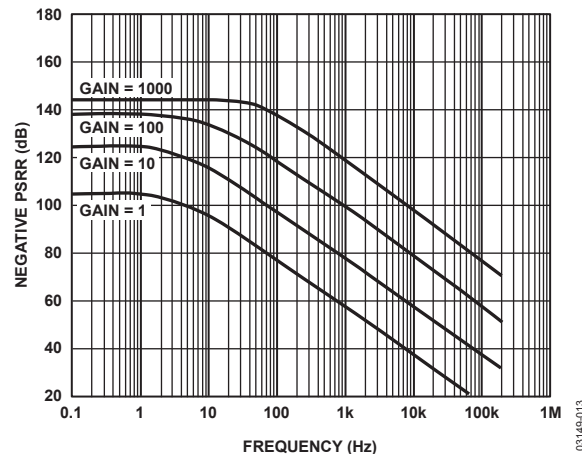

Figure 14. Negative PSRR vs. Frequency, RTI ($G = 1$ to 1000)

03149-013

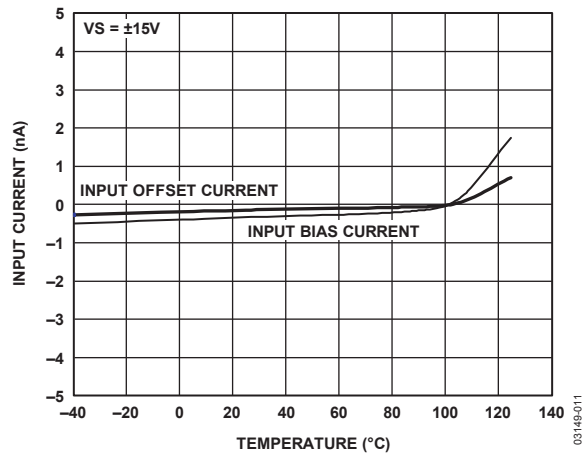

Figure 12. Input Bias Current and Offset Current vs. Temperature

03149-011

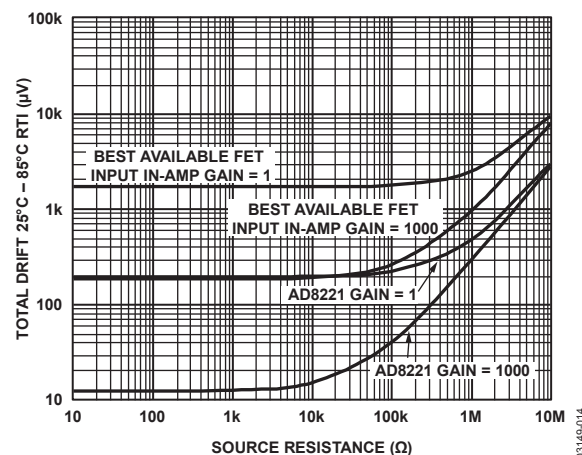

Figure 15. Total Drift vs. Source Resistance

03149-014

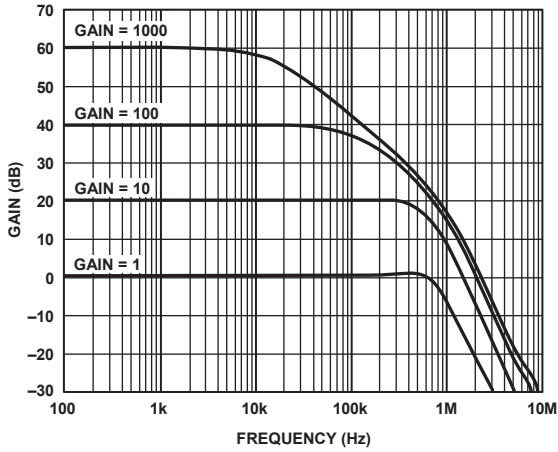

Figure 16. Gain vs. Frequency

03149-015

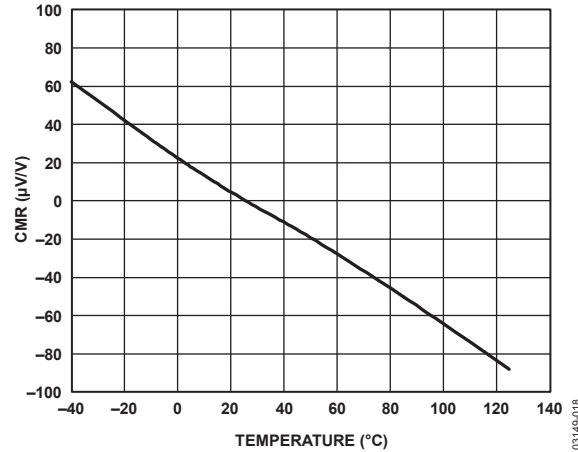

Figure 19. CMR vs. Temperature

03149-018

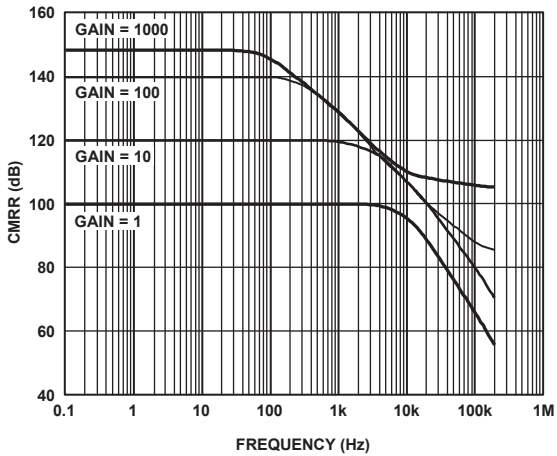

Figure 17. CMRR vs. Frequency, RTI

03149-016

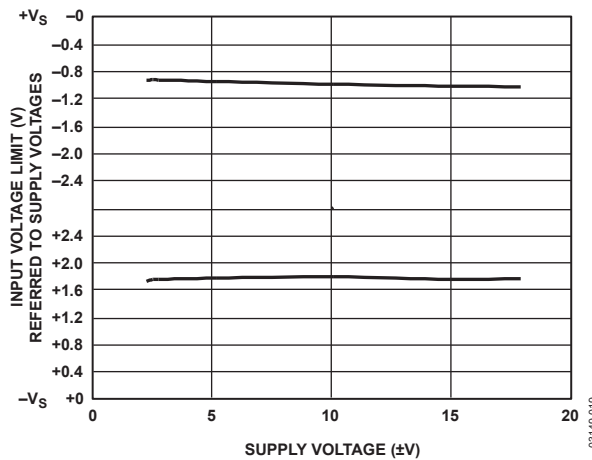

Figure 20. Input Voltage Limit vs. Supply Voltage, $G = 1$

03149-019

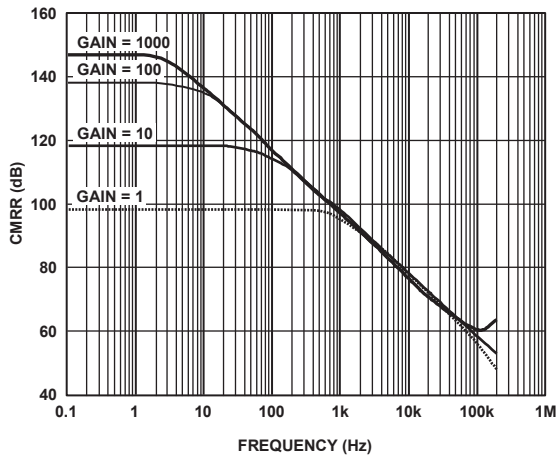

Figure 18. CMRR vs. Frequency, RTI, 1 kΩ Source Imbalance

03149-017

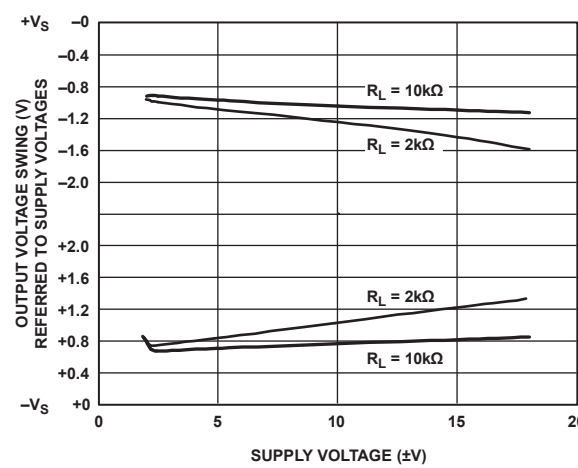

Figure 21. Output Voltage Swing vs. Supply Voltage, $G = 1$

03149-020

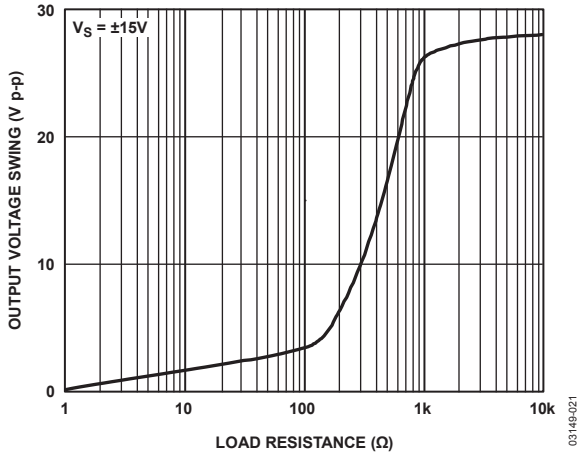

Figure 22. Output Voltage Swing vs. Load Resistance

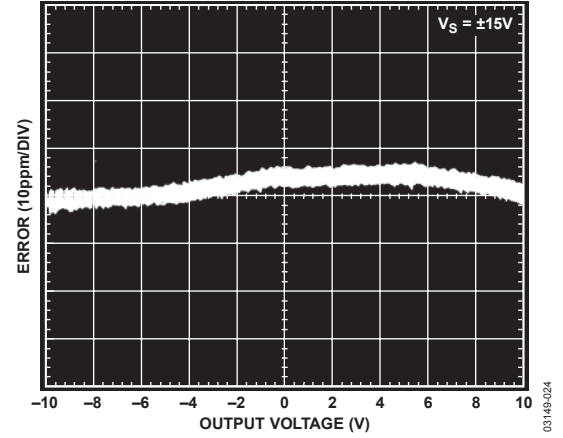

Figure 25. Gain Nonlinearity, $G = 100$, $R_L = 10 \text{ k}\Omega$

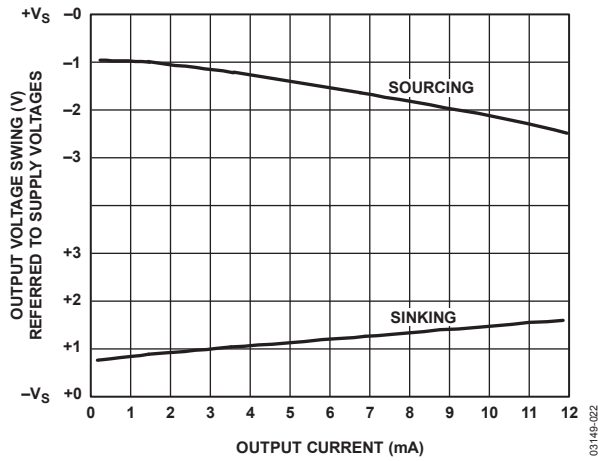

Figure 23. Output Voltage Swing vs. Output Current, $G = 1$

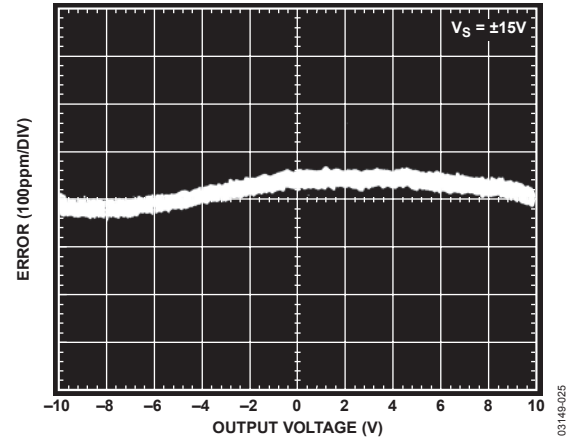

Figure 26. Gain Nonlinearity, $G = 1000$, $R_L = 10 \text{ k}\Omega$

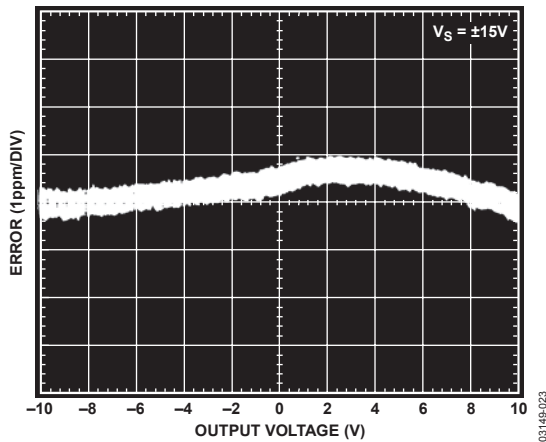

Figure 24. Gain Nonlinearity, $G = 1$, $R_L = 10 \text{ k}\Omega$

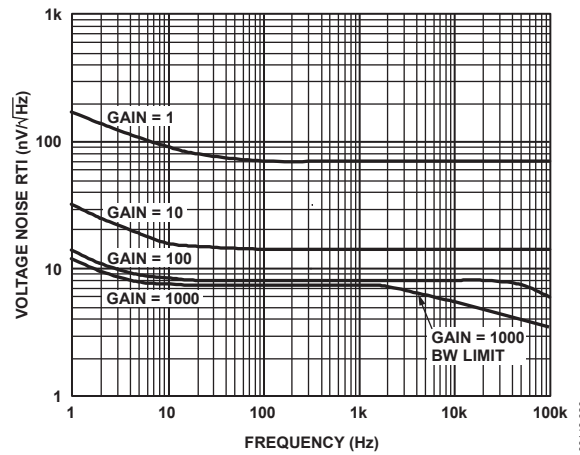

Figure 27. Voltage Noise Spectral Density vs. Frequency ($G = 1$ to 1000)

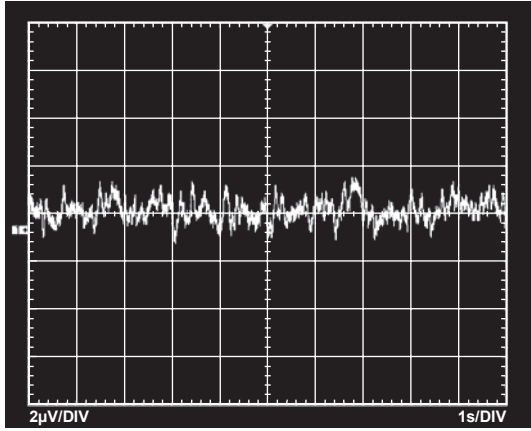

Figure 28. 0.1 Hz to 10 Hz RTI Voltage Noise (G = 1)

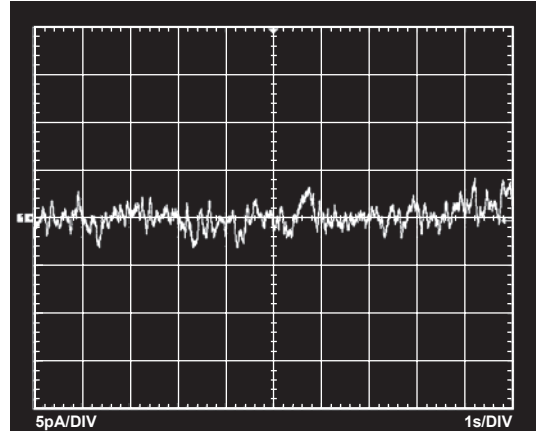

Figure 31. 0.1 Hz to 10 Hz Current Noise

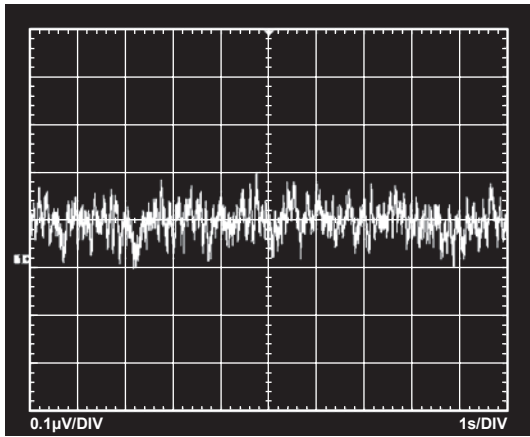

Figure 29. 0.1 Hz to 10 Hz RTI Voltage Noise (G = 1000)

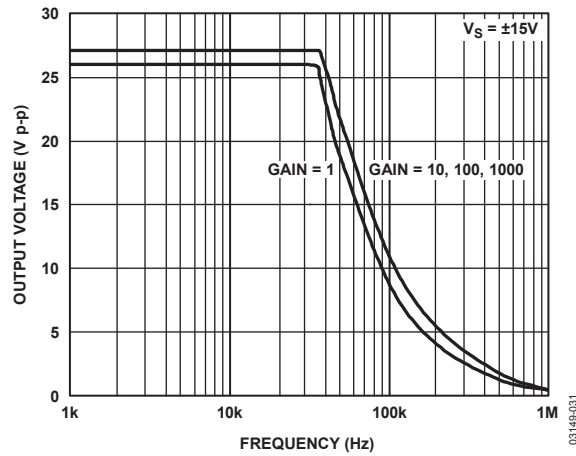

Figure 32. Large Signal Frequency Response

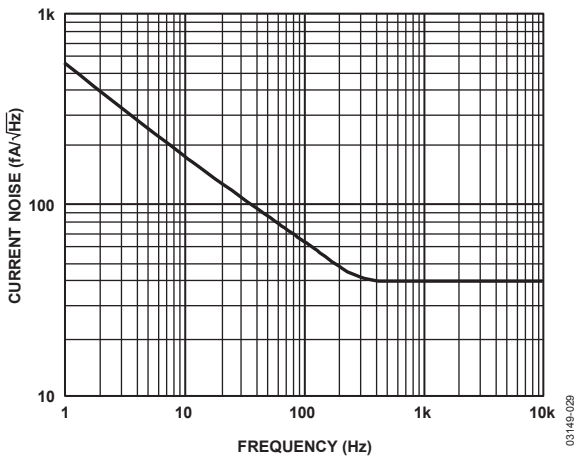

Figure 30. Current Noise Spectral Density vs. Frequency

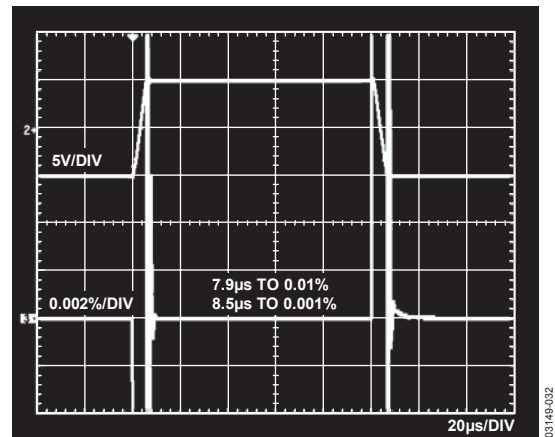

Figure 33. Large Signal Pulse Response and Settling Time (G = 1), 0.002%/DIV

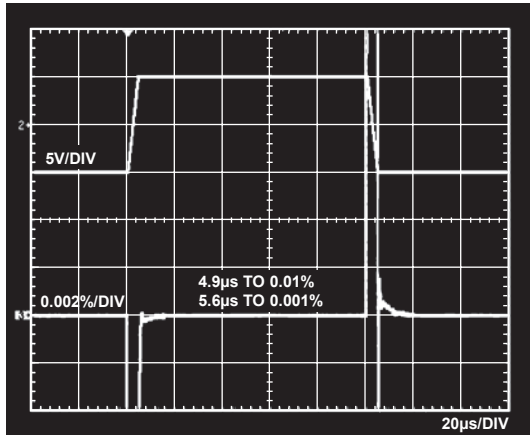

Figure 34. Large Signal Pulse Response and Settling Time ($G = 10$), 0.002%/DIV

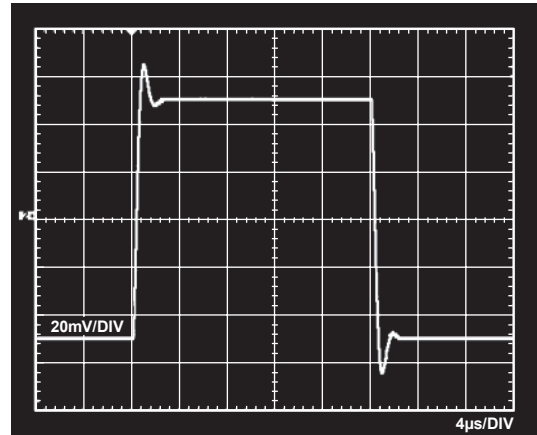

Figure 37. Small Signal Response, $G = 1$, $R_L = 2\text{ k}\Omega$, $C_L = 100\text{ pF}$

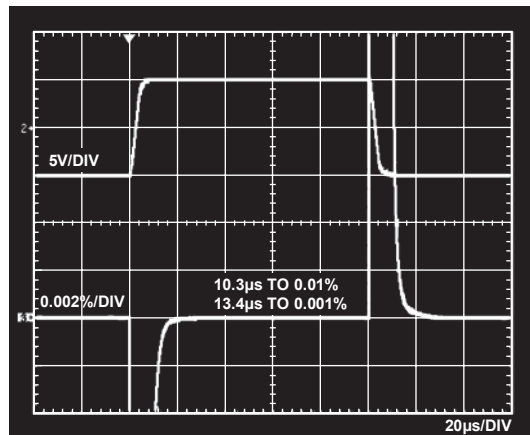

Figure 35. Large Signal Pulse Response and Settling Time ($G = 100$), 0.002%/DIV

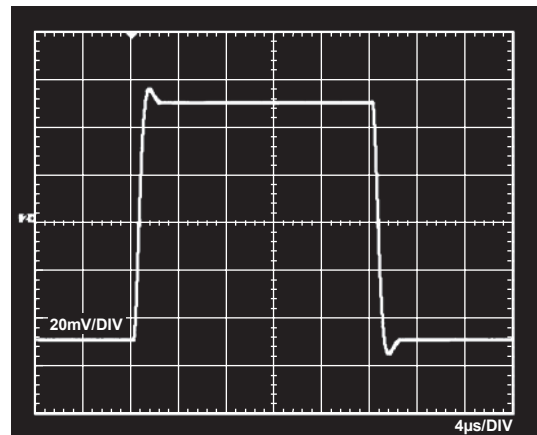

Figure 38. Small Signal Response, $G = 10$, $R_L = 2\text{ k}\Omega$, $C_L = 100\text{ pF}$

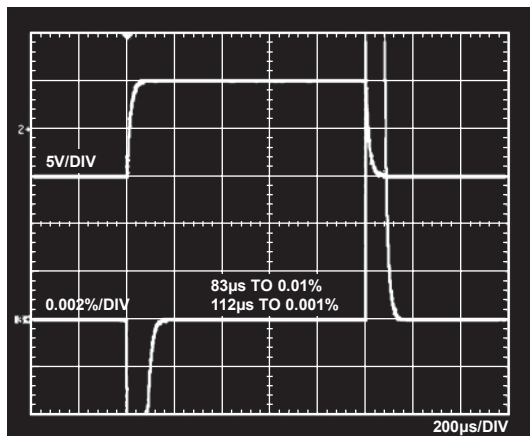

Figure 36. Large Signal Pulse Response and Settling Time ($G = 1000$), 0.002%/DIV

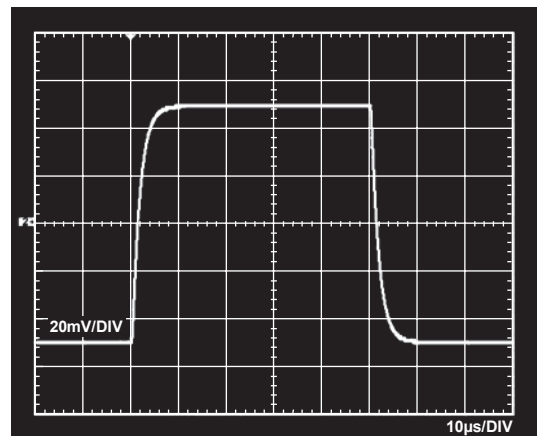

Figure 39. Small Signal Response, $G = 100$, $R_L = 2\text{ k}\Omega$, $C_L = 100\text{ pF}$

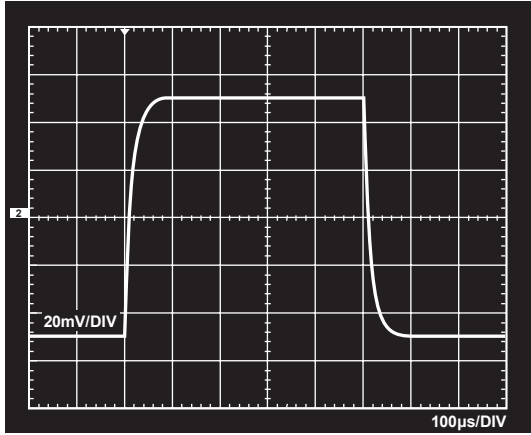

Figure 40. Small Signal Response, $G = 1000$, $R_L = 2\text{ k}\Omega$, $C_L = 100\text{ pF}$

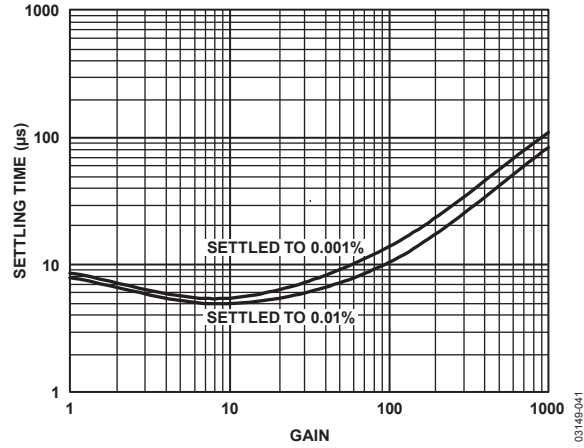

Figure 42. Settling Time vs. Gain for a 10 V Step

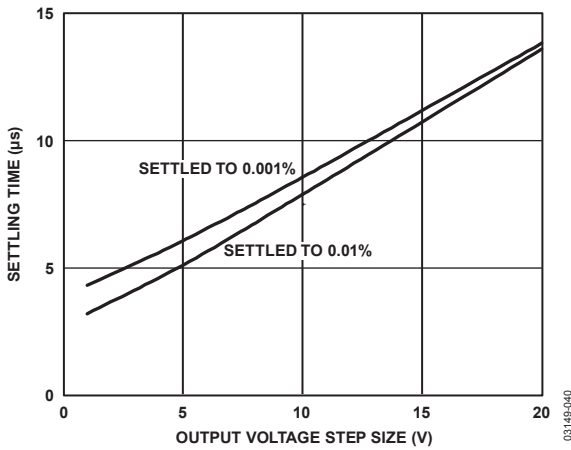

Figure 41. Settling Time vs. Step Size ($G = 1$)

THEORY OF OPERATION

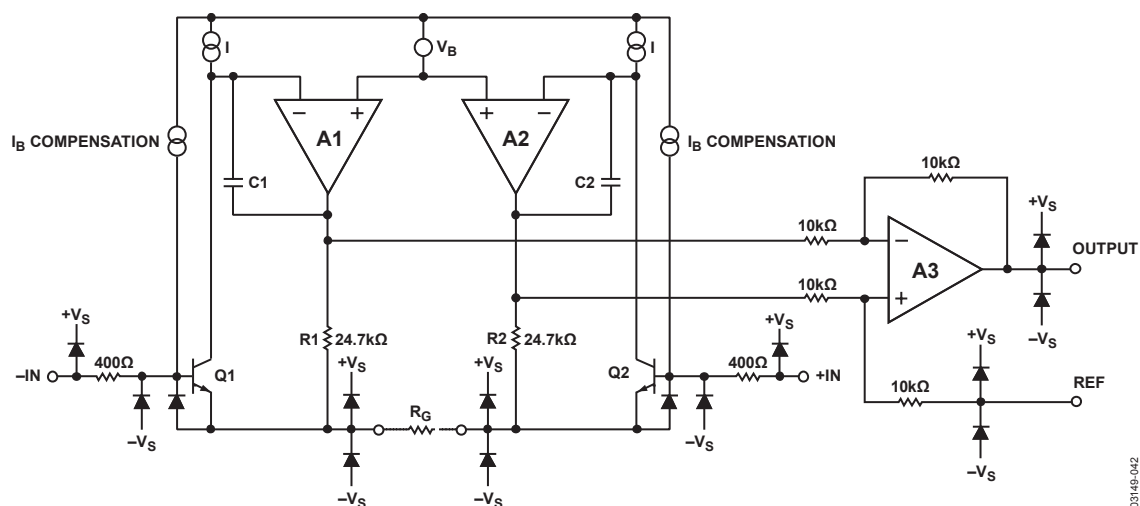

Figure 43. Simplified Schematic

The AD8221 is a monolithic instrumentation amplifier based on the classic 3-op amp topology. Input transistors Q1 and Q2 are biased at a fixed current so that any differential input signal forces the output voltages of A1 and A2 to change accordingly. A signal applied to the input creates a current through R_G , R1, and R2, such that the outputs of A1 and A2 deliver the correct voltage. Topologically, Q1, A1, R1 and Q2, A2, R2 can be viewed as precision current feedback amplifiers. The amplified differential and common-mode signals are applied to a difference amplifier that rejects the common-mode voltage but amplifies the differential voltage. The difference amplifier employs innovations that result in low output offset voltage as well as low output offset voltage drift. Laser-trimmed resistors allow for a highly accurate in-amp with gain error typically less than 20 ppm and CMRR that exceeds 90 dB ($G = 1$).

Using superbeta input transistors and an I_B compensation scheme, the AD8221 offers extremely high input impedance, low I_B , low I_B drift, low I_{OS} , low input bias current noise, and extremely low voltage noise of $8 \text{ nV}/\sqrt{\text{Hz}}$.

The transfer function of the AD8221 is

$$G = 1 + \frac{49.4 \text{ k}\Omega}{R_G}$$

Users can easily and accurately set the gain using a single standard resistor.

Because the input amplifiers employ a current feedback architecture, the gain-bandwidth product of the AD8221 increases with gain, resulting in a system that does not suffer from the expected bandwidth loss of voltage feedback architectures at higher gains.

To maintain precision even at low input levels, special attention was given to the design and layout of the AD8221, resulting in an in-amp whose performance satisfies the most demanding applications.

A unique pinout enables the AD8221 to meet a CMRR specification of 80 dB at 10 kHz ($G = 1$) and 110 dB at 1 kHz ($G = 1000$). The balanced pinout, shown in Figure 44, reduces the parasitics that had, in the past, adversely affected CMRR performance. In addition, the new pinout simplifies board layout because associated traces are grouped together. For example, the gain setting resistor pins are adjacent to the inputs, and the reference pin is next to the output.

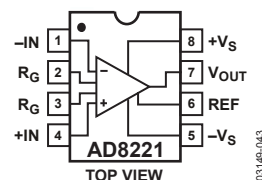

Figure 44. Pinout Diagram

AD8221

GAIN SELECTION

Placing a resistor across the R_G terminals set the gain of AD8221, which can be calculated by referring to Table 6 or by using the gain equation.

$$R_G = \frac{49.4 \text{ k}\Omega}{G - 1}$$

Table 6. Gains Achieved Using 1% Resistors

1% Standard Table Value of R_G (Ω)	Calculated Gain
49.9 k	1.990
12.4 k	4.984
5.49 k	9.998
2.61 k	19.93
1.00 k	50.40
499	100.0
249	199.4
100	495.0
49.9	991.0

The AD8221 defaults to $G = 1$ when no gain resistor is used. Gain accuracy is determined by the absolute tolerance of R_G . The TC of the external gain resistor increases the gain drift of the instrumentation amplifier. Gain error and gain drift are kept to a minimum when the gain resistor is not used.

LAYOUT

Careful board layout maximizes system performance. Traces from the gain setting resistor to the R_G pins should be kept as short as possible to minimize parasitic inductance. To ensure the most accurate output, the trace from the REF pin should either be connected to the local ground of the AD8221, as shown in Figure 47, or connected to a voltage that is referenced to the local ground of the AD8221.

Common-Mode Rejection

One benefit of the high CMRR over frequency of the AD8221 is that it has greater immunity to disturbances, such as line noise and its associated harmonics, than do typical instrumentation amplifiers. Typically, these amplifiers have CMRR fall-off at 200 Hz; common-mode filters are often used to compensate for this shortcoming. The AD8221 is able to reject CMRR over a greater frequency range, reducing the need for filtering.

A well implemented layout helps to maintain the high CMRR over frequency of the AD8221. Input source impedance and capacitance should be closely matched. In addition, source resistance and capacitance should be placed as close to the inputs as permissible.

Grounding

The output voltage of the AD8221 is developed with respect to the potential on the reference terminal. Care should be taken to tie REF to the appropriate local ground.

In mixed-signal environments, low level analog signals need to be isolated from the noisy digital environment. Many ADCs have separate analog and digital ground pins. Although it is convenient to tie both grounds to a single ground plane, the current traveling through the ground wires and PC board may cause hundreds of millivolts of error. Therefore, separate analog and digital ground returns should be used to minimize the current flow from sensitive points to the system ground. An example layout is shown in Figure 45 and Figure 46.

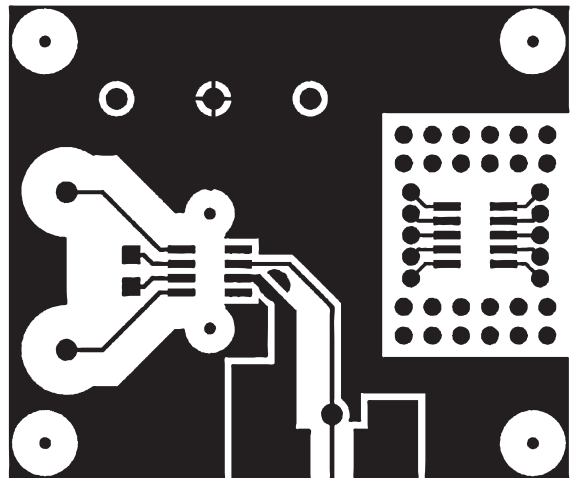

Figure 45. Top Layer of the AD8221-EVAL

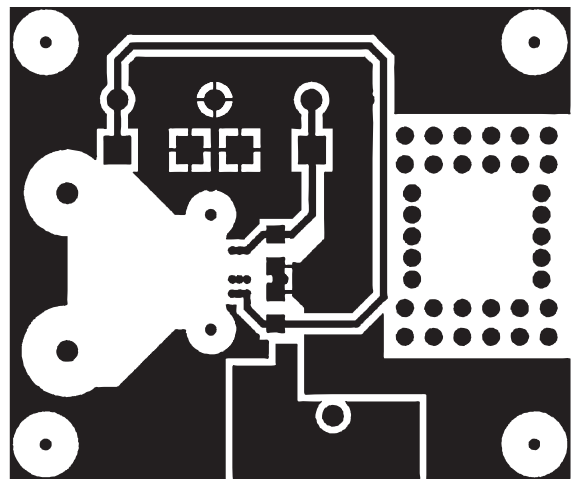

Figure 46. Bottom Layer of the AD8221-EVAL

REFERENCE TERMINAL

As shown in Figure 43, the reference terminal, REF, is at one end of a 10 k Ω resistor. The output of the instrumentation amplifier is referenced to the voltage on the REF terminal; this is useful when the output signal needs to be offset to a precise midsupply level. For example, a voltage source can be tied to the REF pin to level-shift the output so that the AD8221 can interface with an ADC. The allowable reference voltage range is a function of the gain, input, and supply voltage. The REF pin should not exceed either +V_S or -V_S by more than 0.5 V.

For best performance, source impedance to the REF terminal should be kept low, because parasitic resistance can adversely affect CMRR and gain accuracy.

POWER SUPPLY REGULATION AND BYPASSING

A stable dc voltage should be used to power the instrumentation amplifier. Noise on the supply pins can adversely affect performance. Bypass capacitors should be used to decouple the amplifier.

A 0.1 μ F capacitor should be placed close to each supply pin. As shown in Figure 47, a 10 μ F tantalum capacitor can be used further away from the part. In most cases, it can be shared by other precision integrated circuits.

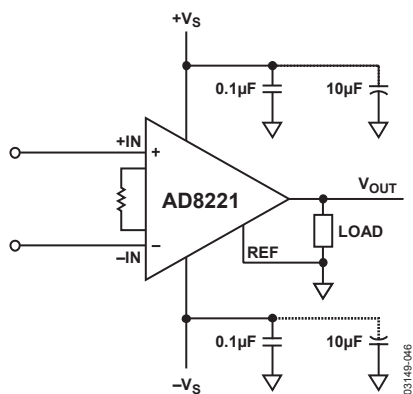
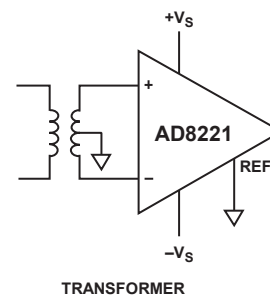

Figure 47. Supply Decoupling, REF, and Output Referred to Local Ground

INPUT BIAS CURRENT RETURN PATH

The input bias current of the AD8221 must have a return path to common. When the source, such as a thermocouple, cannot provide a return current path, one should be created, as shown in Figure 48.



TRANSFORMER

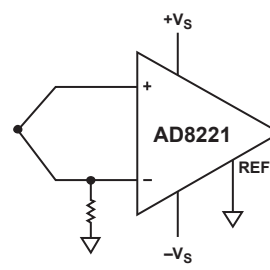

THERMOCOUPLE

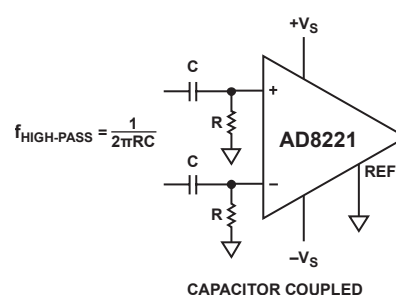

CAPACITOR COUPLED

03149-047

Figure 48. Creating an I_{BIAS} Path

INPUT PROTECTION

All terminals of the AD8221 are protected against ESD, 1 kV Human Body Model. In addition, the input structure allows for dc overload conditions below the negative supply, -V_S. The internal 400 Ω resistors limit current in the event of a negative fault condition. However, in the case of a dc overload voltage above the positive supply, +V_S, a large current flows directly through the ESD diode to the positive rail. Therefore, an external resistor should be used in series with the input to limit current for voltages above +V_S. In either scenario, the AD8221 can safely handle a continuous 6 mA current, $I = V_{IN}/R_{EXT}$ for positive overvoltage and $I = V_{IN}/(400 \Omega + R_{EXT})$ for negative overvoltage.

For applications where the AD8221 encounters extreme overload voltages, as in cardiac defibrillators, external series resistors, and low leakage diode clamps, such as BAV199Ls, FJH1100s, or SP720s should be used.

AD8221

RF INTERFERENCE

RF rectification is often a problem when amplifiers are used in applications where there are strong RF signals. The disturbance can appear as a small dc offset voltage. High frequency signals can be filtered with a low-pass RC network placed at the input of the instrumentation amplifier, as shown in Figure 49. The filter limits the input signal bandwidth according to the following relationship:

$$FilterFreq_{diff} = \frac{1}{2\pi R(2C_D + C_C)}$$

$$FilterFreq_{CM} = \frac{1}{2\pi R C_C}$$

where $C_D \geq 10C_C$.

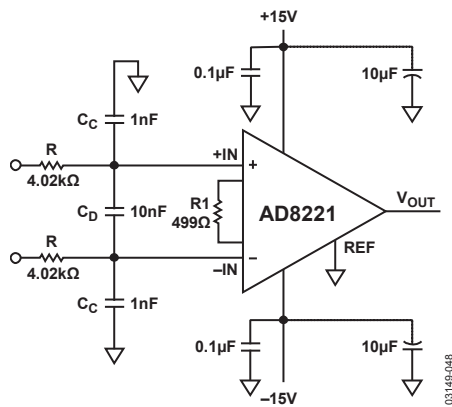

Figure 49. RFI Suppression

C_D affects the difference signal, and C_C affects the common-mode signal. Values of R and C_C should be chosen to minimize RFI. Mismatch between the $R \times C_C$ at the positive input and the $R \times C_C$ at the negative input degrades the CMRR of the AD8221. By using a value of C_D one magnitude larger than C_C , the effect of the mismatch is reduced, and therefore, performance is improved.

PRECISION STRAIN GAGE

The low offset and high CMRR over frequency of the AD8221 make it an excellent candidate for bridge measurements. As shown in Figure 50, the bridge can be directly connected to the inputs of the amplifier.

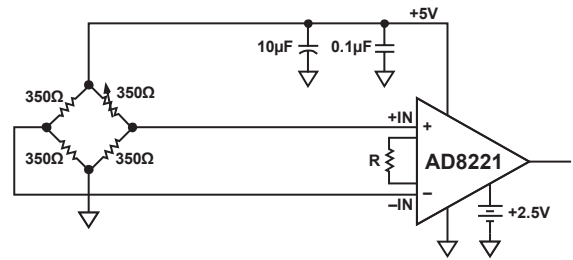

Figure 50. Precision Strain Gage

CONDITIONING ±10 V SIGNALS FOR A +5 V DIFFERENTIAL INPUT ADC

There is a need in many applications to condition ±10 V signals. However, many of today's ADCs and digital ICs operate on much lower, single-supply voltages. Furthermore, new ADCs have differential inputs because they provide better common-mode rejection, noise immunity, and performance at low supply voltages. Interfacing a ±10 V, single-ended instrumentation amplifier to a +5 V, differential ADC can be a challenge. Interfacing the instrumentation amplifier to the ADC requires attenuation and a level shift. A solution is shown in Figure 51.

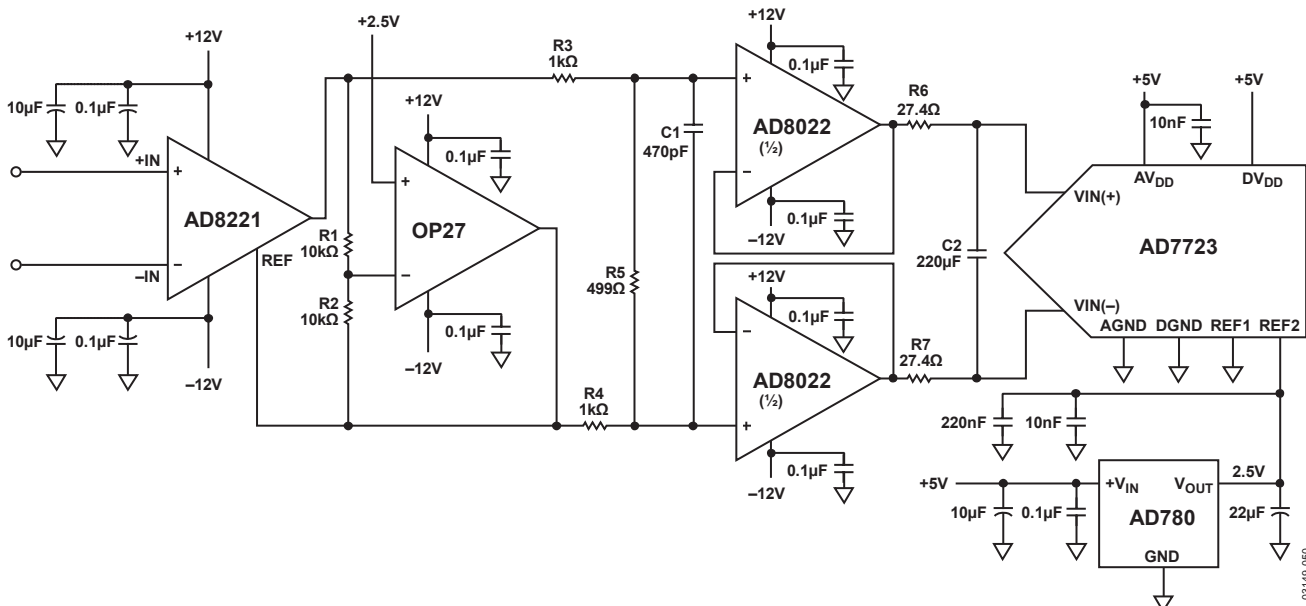

Figure 51. Interfacing to a Differential Input ADC

In this topology, an OP27 sets the reference voltage of the AD8221. The output signal of the instrumentation amplifier is taken across the OUT pin and the REF pin. Two 1 k Ω resistors and a 499 Ω resistor attenuate the ± 10 V signal to +4 V. An optional capacitor, C1, can serve as an antialiasing filter. An AD8022 is used to drive the ADC.

This topology has five benefits. In addition to level-shifting and attenuation, very little noise is contributed to the system. Noise from R1 and R2 is common to both of the inputs of the ADC and is easily rejected. R5 adds a third of the dominant noise and therefore makes a negligible contribution to the noise of the system. The attenuator divides the noise from R3 and R4. Likewise, its noise contribution is negligible. The fourth benefit of this interface circuit is that the acquisition time of the AD8221 is reduced by a factor of 2. With the help of the OP27, the AD8221 only needs to deliver one-half of the full swing; therefore, signals can settle more quickly. Lastly, the AD8022 settles quickly, which is helpful because the shorter the settling time, the more bits that can be resolved when the ADC acquires data. This configuration provides attenuation, a level-shift, and a convenient interface with a differential input ADC while maintaining performance.

AC-COUPLED INSTRUMENTATION AMPLIFIER

Measuring small signals that are in the noise or offset of the amplifier can be a challenge. Figure 52 shows a circuit that can improve the resolution of small ac signals. The large gain

reduces the referred input noise of the amplifier to $8 \text{ nV}/\sqrt{\text{Hz}}$. Thus, smaller signals can be measured because the noise floor is lower. DC offsets that would have been gained by 100 are eliminated from the output of the AD8221 by the integrator feedback network.

At low frequencies, the OP1177 forces the output of the AD8221 to 0 V. Once a signal exceeds $f_{\text{HIGH-PASS}}$, the AD8221 outputs the amplified input signal.

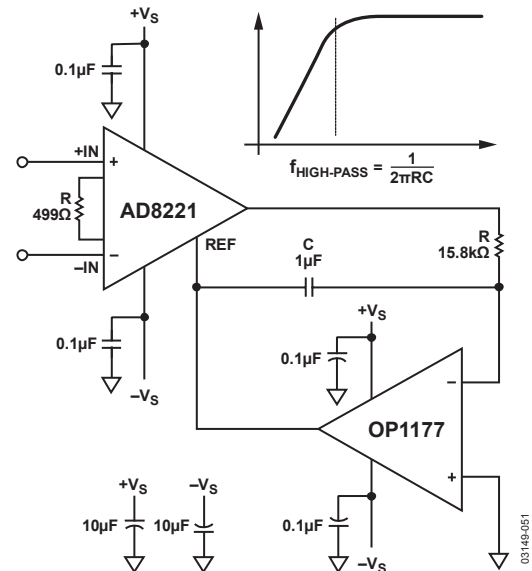

Figure 52. AC-Coupled Circuit

AD8221

DIE INFORMATION

Die size: 1575 μm \times 2230 μm

Die thickness: 381 μm

To minimize gain errors introduced by the bond wires, use Kelvin connections between the chip and the gain resistor, R_G , by connecting Pad 2A and Pad 2B in parallel to one end of R_G and Pad 3A and Pad 3B in parallel to the other end of R_G . For unity gain applications where R_G is not required, Pad 2A and Pad 2B must be bonded together as well as the Pad 3A and Pad 3B.

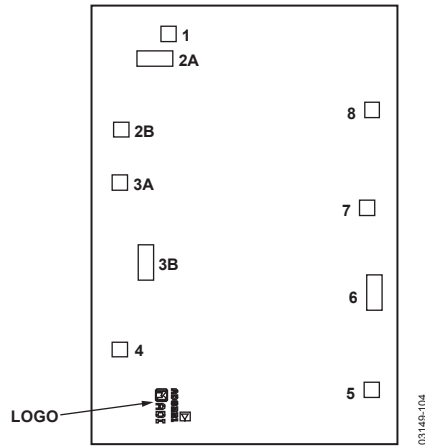

Figure 53. Bond Pad Diagram

Table 7. Bond Pad Information

Pad No.	Mnemonic	Pad Coordinates ¹	
		X (μm)	Y (μm)
1	-IN	-379	+951
2A	R_G	-446	+826
2B	R_G	-615	+474
3A	R_G	-619	+211
3B	R_G	-490	-190
4	+IN	-621	-622
5	$-V_S$	+635	-823
6	REF	+649	-339
7	V_{OUT}	+612	+84
8	$+V_S$	+636	+570

¹ The pad coordinates indicate the center of each pad, referenced to the center of the die. The die orientation is indicated by the logo, as shown in Figure 53.

OUTLINE DIMENSIONS

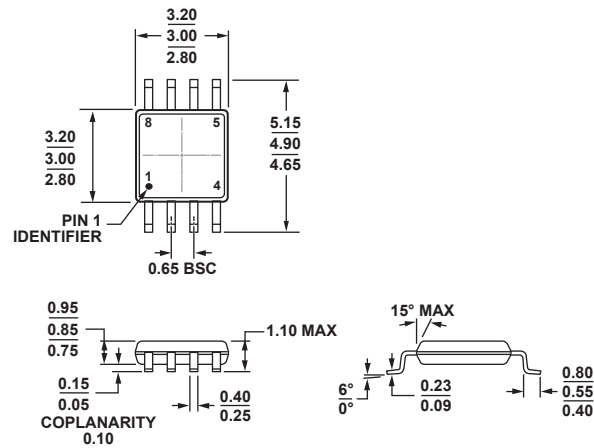

COMPLIANT TO JEDEC STANDARDS MO-187-AA

Figure 54. 8-Lead Mini Small Outline Package [MSOP] (RM-8)

Dimensions shown in millimeters

10-07-2009-B

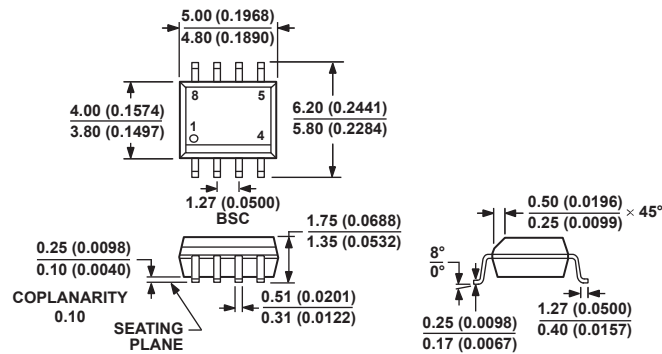

COMPLIANT TO JEDEC STANDARDS MS-012-AA

CONTROLLING DIMENSIONS ARE IN MILLIMETERS; INCH DIMENSIONS (IN PARENTHESES) ARE ROUNDED-OFF MILLIMETER EQUIVALENTS FOR REFERENCE ONLY AND ARE NOT APPROPRIATE FOR USE IN DESIGN.

Figure 55. 8-Lead Standard Small Outline Package [SOIC_N]

Narrow Body

(R-8)

Dimensions shown in millimeters and (inches)

012A07-A

AD8221

ORDERING GUIDE

Model ¹	Temperature Range for Specified Performance	Operating ² Temperature Range	Package Description	Package Option	Branding
AD8221AR	-40°C to +85°C	-40°C to +125°C	8-Lead SOIC_N	R-8	
AD8221AR-REEL	-40°C to +85°C	-40°C to +125°C	8-Lead SOIC_N, 13" Tape and Reel	R-8	
AD8221AR-REEL7	-40°C to +85°C	-40°C to +125°C	8-Lead SOIC_N, 7" Tape and Reel	R-8	
AD8221ARZ	-40°C to +85°C	-40°C to +125°C	8-Lead SOIC_N	R-8	
AD8221ARZ-R7	-40°C to +85°C	-40°C to +125°C	8-Lead SOIC_N, 7" Tape and Reel	R-8	
AD8221ARZ-RL	-40°C to +85°C	-40°C to +125°C	8-Lead SOIC_N, 13" Tape and Reel	R-8	
AD8221ARM	-40°C to +85°C	-40°C to +125°C	8-Lead MSOP	RM-8	JLA
AD8221ARM-REEL	-40°C to +85°C	-40°C to +125°C	8-Lead MSOP, 13" Tape and Reel	RM-8	JLA
AD8221ARM REEL7	-40°C to +85°C	-40°C to +125°C	8-Lead MSOP, 7" Tape and Reel	RM-8	JLA
AD8221ARMZ	-40°C to +85°C	-40°C to +125°C	8-Lead MSOP	RM-8	JLA#
AD8221ARMZ-R7	-40°C to +85°C	-40°C to +125°C	8-Lead MSOP, 7" Tape and Reel	RM-8	JLA#
AD8221ARMZ-RL	-40°C to +85°C	-40°C to +125°C	8-Lead MSOP, 13" Tape and Reel	RM-8	JLA#
AD8221BR	-40°C to +85°C	-40°C to +125°C	8-Lead SOIC_N	R-8	
AD8221BR-REEL	-40°C to +85°C	-40°C to +125°C	8-Lead SOIC_N, 13" Tape and Reel	R-8	
AD8221BR-REEL7	-40°C to +85°C	-40°C to +125°C	8-Lead SOIC_N, 7" Tape and Reel	R-8	
AD8221BRZ	-40°C to +85°C	-40°C to +125°C	8-Lead SOIC_N	R-8	
AD8221BRZ-R7	-40°C to +85°C	-40°C to +125°C	8-Lead SOIC_N, 7" Tape and Reel	R-8	
AD8221BRZ-RL	-40°C to +85°C	-40°C to +125°C	8-Lead SOIC_N, 13" Tape and Reel	R-8	
AD8221AC-P7	-40°C to +85°C	-40°C to +125°C	Die		

¹ Z = RoHS Compliant Part, # denotes RoHS compliant product may be top or bottom marked.

² See Typical Performance Characteristics for expected operation from 85°C to 125°C.

X-ON Electronics

Largest Supplier of Electrical and Electronic Components

Click to view similar products for [Instrumentation Amplifiers](#) category:

Click to view products by [Analog Devices](#) manufacturer:

Other Similar products are found below :

[ADA4254RU-EBZ](#) [JM38510/13501BGA](#) [MCP6N16-001E/MF](#) [LT1102IN8#PBF](#) [AD694BRZ-REEL7](#) [LT1101ISW](#) [JM38510/13502BGA](#)
[AD521JDZ](#) [AD521KDZ](#) [AD521LDZ](#) [AD524ADZ](#) [AD524BDZ](#) [AD524CDZ](#) [AD620ANZ](#) [AD621BNZ](#) [AD621BR](#) [AD622ANZ](#) [AD623ANZ](#)
[AD623BNZ](#) [AD624ADZ](#) [AD624CDZ](#) [AD624SD/883B](#) [AD625ADZ](#) [AD625BDZ](#) [AD625JNZ](#) [AD625KNZ](#) [AD625SD](#) [AD627BNZ](#)
[AD693AD](#) [AD693AE](#) [AD693AQ](#) [AD694AQ](#) [AD694ARZ-REEL](#) [AD694BRZ-REEL](#) [AD694JNZ](#) [AD8221ARMZ-R7](#) [AD8222HBCPZ-WP](#)
[AD8224ACPZ-R7](#) [AD8224BCPZ-WP](#) [AD8224HBCPZ-WP](#) [AD8226ARMZ-R7](#) [AD8228ARMZ](#) [AD8228ARMZ-R7](#) [AD8229HDZ](#)
[AD8236ARMZ-R7](#) [AD8237ARMZ-R7](#) [AD8253ARMZ](#) [AD8293G160BRJZ-R7](#) [AD8293G80BRJZ-R2](#) [AD8553ARMZ](#)