

### FEATURES

No External Components Required  
 Highly Stable, Factory Trimmed Gain of 5  
 Low Power, 1.2 mA Max Supply Current  
 Wide Power Supply Range ( $\pm 1.7$  V to  $\pm 18$  V)  
 Single- and Dual-Supply Operation  
 Excellent Dynamic Performance

#### High CMRR

86 dB Min @ DC  
 80 dB Min to 10 kHz

#### Wide Bandwidth

900 kHz

4 V to 36 V Single Supply

#### High Slew Rate

5 V/ $\mu$ s Min

#### Outstanding DC Precision

##### Low Gain Drift

5 ppm/ $^{\circ}$ C Max

##### Low Input Offset Voltage

150  $\mu$ V Max

##### Low Offset Drift

2  $\mu$ V/ $^{\circ}$ C Max

##### Low Input Bias Current

1.2 nA Max

### APPLICATIONS

Patient Monitors  
 Current Transmitters  
 Multiplexed Systems  
 4 to 20 mA Converters  
 Bridge Transducers  
 Sensor Signal Conditioning

### GENERAL DESCRIPTION

The AD8225 is an instrumentation amplifier with a fixed gain of 5, which sets new standards of performance. The superior CMRR of the AD8225 enables rejection of high frequency common-mode voltage (80 dB Min @ 10 kHz). As a result, higher ambient levels of noise from utility lines, industrial equipment, and other radiating sources are rejected. Extended CMV range enables the AD8225 to extract low level differential signals in the presence of high common-mode dc voltage levels even at low supply voltages.

Ambient electrical noise from utility lines is present at 60 Hz and harmonic frequencies. Power systems operating at 400 Hz create high noise environments in aircraft instrument clusters. Good CMRR performance over frequency is necessary if power system generated noise is to be rejected. The dc to 10 kHz

### FUNCTIONAL BLOCK DIAGRAM

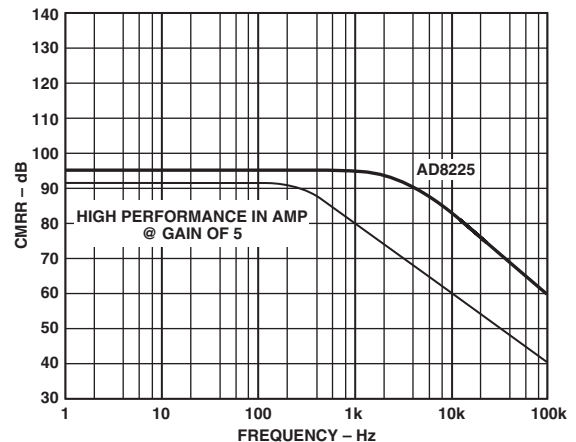
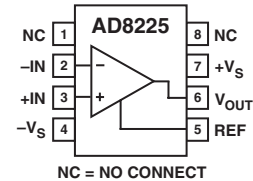

Figure 1. Typical CMRR vs. Frequency

CMRR performance of the AD8225 rejects noise from utility systems, motors, and repair equipment on factory floors, switching power supplies, and medical equipment.

Low input bias currents combined with a high slew rate of 5 V/ $\mu$ s make the AD8225 ideally suited for multiplexed applications.

The AD8225 provides excellent dc precision, with maximum input offset voltage of 150  $\mu$ V and drift of 2  $\mu$ V/ $^{\circ}$ C. Gain drift is 5 ppm/ $^{\circ}$ C or less.

Operating on either single or dual supplies, the fixed gain of 5 and wide input common-mode voltage range make the AD8225 well suited for patient monitoring applications.

The AD8225 is packaged in an 8-lead SOIC package and is specified over the standard industrial temperature range,  $-40^{\circ}$ C to  $+85^{\circ}$ C.

### REV. A

Information furnished by Analog Devices is believed to be accurate and reliable. However, no responsibility is assumed by Analog Devices for its use, nor for any infringements of patents or other rights of third parties that may result from its use. No license is granted by implication or otherwise under any patent or patent rights of Analog Devices. Trademarks and registered trademarks are the property of their respective companies.

# AD8225—SPECIFICATIONS ( $T_A = 25^\circ\text{C}$ , $V_S = \pm 15\text{ V}$ , $R_L = 2\text{ k}\Omega$ , unless otherwise noted.)

Parameter	Conditions	Min	Typ	Max	Unit
<b>GAIN</b>					
Gain			5		V/V
Gain Error		-0.1	+0.05	+0.1	%
Nonlinearity			2	10	$\pm$ ppm
vs. Temperature			1	5	$\pm$ ppm/ $^\circ\text{C}$
<b>OFFSET VOLTAGE (RTI)</b>					
Offset Voltage			50	150	$\pm\mu\text{V}$
vs. Temperature			0.3	2	$\pm\mu\text{V}/^\circ\text{C}$
vs. Supply (PSRR)		90	100		dB
<b>INPUT</b>					
Input Operating Impedance					
Differential			10  2		$\text{G}\Omega  \text{pF}$
Common Mode			10  2		$\text{G}\Omega  \text{pF}$
Input Voltage Range		$-V_S + 1.6$		$+V_S - 1.0$	V
(Common-Mode)					
vs. Temperature		$-V_S + 2.2$		$+V_S - 1.2$	V
Input Bias Current			0.5	1.2	nA
vs. Temperature			3		$\text{pA}/^\circ\text{C}$
Input Offset Current			0.15	0.5	nA
vs. Temperature			1.5		$\text{pA}/^\circ\text{C}$
Common-Mode Rejection Ratio		86	94		dB
	$T_A = T_{\text{MIN}}$ to $T_{\text{MAX}}$	83			dB
	$f = 10\text{ kHz}^*$	80			dB
<b>OUTPUT</b>					
Operating Voltage Range	$R_L = 2\text{ k}\Omega$	$-V_S + 1.4$		$+V_S - 1.4$	V
vs. Temperature		$-V_S + 1.5$		$+V_S - 1.6$	V
Operating Voltage Range	$R_L = 10\text{ k}\Omega$	$-V_S + 1.0$		$+V_S - 1.1$	V
vs. Temperature		$-V_S + 1.2$		$+V_S - 1.0$	V
Short Circuit Current			18		mA
<b>DYNAMIC RESPONSE</b>					
Small Signal -3 dB Bandwidth			900		kHz
Full Power Bandwidth	$V_{\text{OUT}} = 20\text{ V p-p}$		75		kHz
Settling Time (0.01%)	10 V Step		3.4		$\mu\text{s}$
Settling Time (0.001%)	10 V Step		4.8		$\mu\text{s}$
Slew Rate		5			V/ $\mu\text{s}$
<b>NOISE (RTI)</b>					
Voltage	0.1 Hz to 10 Hz		1.5		$\mu\text{V p-p}$
	Spectral Density, 1 kHz		45		$\text{nV}/\sqrt{\text{Hz}}$
Current	0.1 Hz to 10 Hz		4		$\text{pA p-p}$
	Spectral Density, 1 kHz		50		$\text{fA}/\sqrt{\text{Hz}}$
<b>REFERENCE INPUT</b>					
$R_{\text{IN}}$	$V_{\text{IN+}}, V_{\text{REF}} = 0$		18		k $\Omega$
$I_{\text{IN}}$			60		$\mu\text{A}$
Voltage Range		$-V_S + 1.4$		$+V_S - 1.4$	V
Gain to Output		0.999	1	1.001	
<b>POWER SUPPLY</b>					
Operating Range		1.7		18	$\pm\text{V}$
Quiescent Current			1.05	1.2	mA
<b>TEMPERATURE RANGE</b>					
For Specified Performance		-40		+85	$^\circ\text{C}$

\*Pin 1 connected to Pin 4. See Applications section.

Specifications subject to change without notice.

# SPECIFICATIONS

( $T_A = 25^\circ\text{C}$ ,  $V_S = \pm 5\text{ V}$ ,  $R_L = 2\text{ k}\Omega$ , unless otherwise noted.)

Parameter	Conditions	Min	Typ	Max	Unit
GAIN					
Gain			5		V/V
Gain Error		-0.1	+0.05	+0.1	%
Nonlinearity			2	10	$\pm$ ppm
vs. Temperature			1	5	$\pm$ ppm/ $^\circ\text{C}$
VOLTAGE OFFSET (RTI)					
Offset Voltage			125	325	$\pm$ $\mu\text{V}$
vs. Temperature				2	$\pm$ $\mu\text{V}/^\circ\text{C}$
vs. Supply		90	100		dB
INPUT					
Input Operating Impedance					
Differential			10  2		$\text{G}\Omega  \text{pF}$
Common-Mode			10  2		$\text{G}\Omega  \text{pF}$
Input Operating Voltage Range		$-V_S + 1.6$		$+V_S - 1.0$	V
vs. Temperature		$-V_S + 2.1$		$+V_S - 1.5$	V
Input Bias Current			0.5	1.2	nA
vs. Temperature			3		$\text{pA}/^\circ\text{C}$
Input Offset Current			0.15	0.5	nA
vs. Temperature			1.5		$\text{pA}/^\circ\text{C}$
Common-Mode Rejection Ratio		86	94		dB
	$T_A = T_{\text{MIN}}$ to $T_{\text{MAX}}$	83			dB
	$f = 10\text{ kHz}^*$	80			dB
OUTPUT					
Operating Voltage Range	$R_L = 2\text{ k}\Omega$	$-V_S + 0.9$		$+V_S - 1.0$	V
vs. Temperature		$-V_S + 1.0$		$+V_S - 1.2$	V
Operating Voltage Range	$R_L = 10\text{ k}\Omega$	$-V_S + 0.8$		$+V_S - 1.0$	V
vs. Temperature		$-V_S + 0.9$		$+V_S - 1.0$	V
Short Circuit Current			18		mA
DYNAMIC RESPONSE					
Small Signal -3 dB Bandwidth			900		kHz
Full Power Bandwidth	$V_{\text{OUT}} = 7.8\text{ V p-p}$		170		kHz
Settling Time (0.01%)	7 V Step		3		$\mu\text{s}$
Settling Time (0.001%)	7 V Step		4.3		$\mu\text{s}$
Slew Rate		5			V/ $\mu\text{s}$
NOISE (RTI)					
Voltage	0.1 Hz to 10 Hz		1.5		$\mu\text{V p-p}$
	Spectral Density, 1 kHz		45		$\text{nV}/\sqrt{\text{Hz}}$
Current	0.1 Hz to 10 Hz		4		$\text{pA p-p}$
	Spectral Density, 1 kHz		50		$\text{fA}/\sqrt{\text{Hz}}$
REFERENCE INPUT					
$R_{\text{IN}}$			18		k $\Omega$
$I_{\text{IN}}$	$V_{\text{INT}}, V_{\text{REF}} = 0$		60		$\mu\text{A}$
Voltage Range		$-V_S + 0.9$		$+V_S - 1.0$	V
Gain to Output		0.999	1	1.001	
POWER SUPPLY					
Operating Range		1.7		18	$\pm$ V
Quiescent Current			1.05	1.2	mA
TEMPERATURE RANGE					
For Specified Performance		-40		+85	$^\circ\text{C}$

\*Pin 1 connected to Pin 4. See Applications section.

Specifications subject to change without notice.

# AD8225

## SPECIFICATIONS ( $T_A = 25^\circ\text{C}$ , $V_S = 5\text{ V}$ , $R_L = 2\text{ k}\Omega$ , unless otherwise noted.)

Parameter	Conditions	Min	Typ	Max	Unit
<b>GAIN</b>					
Gain			5		V/V
Gain Error		-0.1	+0.05	+0.1	%
Nonlinearity			2	10	$\pm$ ppm
vs. Temperature			1	5	$\pm$ ppm/ $^\circ\text{C}$
<b>OFFSET VOLTAGE (RTI)</b>					
Offset Voltage			150	375	$\pm\mu\text{V}$
vs. Temperature				2	$\pm\mu\text{V}/^\circ\text{C}$
vs. Supply		90	100		dB
<b>INPUT</b>					
Input Operating Impedance					
Differential			10  2		$\text{G}\Omega  \text{pF}$
Common Mode			10  2		$\text{G}\Omega  \text{pF}$
Input Voltage Range (Common-Mode)		1.6		$V_S - 1.05$	V
vs. Temperature		1.7		$V_S - 1.0$	V
Input Bias Current			0.5	1.2	nA
vs. Temperature			3		pA/ $^\circ\text{C}$
Input Offset Current			0.15	0.5	nA
vs. Temperature			1.5		pA/ $^\circ\text{C}$
Common-Mode Rejection Ratio		86	94		dB
	$T_A = T_{\text{MIN}}$ to $T_{\text{MAX}}$	83			dB
	$f = 10\text{ kHz}^*$	80			dB
<b>OUTPUT</b>					
Operating Voltage Range	$R_L = 2\text{ k}\Omega$	0.8		$V_S - 1.05$	V
vs. Temperature		0.9		$V_S - 1.2$	V
Operating Voltage Range	$R_L = 10\text{ k}\Omega$	0.8		$V_S - 1.0$	V
vs. Temperature		0.9		$V_S - 1.0$	V
Short Circuit Current			18		mA
<b>DYNAMIC RESPONSE</b>					
Small Signal -3 dB Bandwidth			900		kHz
Full Power Bandwidth	$V_{\text{OUT}} = 3.2\text{ V p-p}$		420		kHz
Settling Time (0.01%)	2 V Step		3.3		$\mu\text{s}$
Settling Time (0.001%)	2 V Step		5.1		$\mu\text{s}$
Slew Rate		5			V/ $\mu\text{s}$
<b>NOISE (RTI)</b>					
Voltage	0.1 Hz to 10 Hz		1.5		$\mu\text{V p-p}$
	Spectral Density, 1 kHz		45		nV/ $\sqrt{\text{Hz}}$
Current	0.1 Hz to 10 Hz		4		pA p-p
	Spectral Density, 1 kHz		50		fA/ $\sqrt{\text{Hz}}$
<b>REFERENCE INPUT</b>					
$R_{\text{IN}}$			18		k $\Omega$
$I_{\text{IN}}$			60		$\mu\text{A}$
Voltage Range		0.4		$V_S - 0.9$	V
Gain to Output		0.999	1	1.001	
<b>POWER SUPPLY</b>					
Operating Range		3.4		36	V
Quiescent Current			1.05	1.2	mA
<b>TEMPERATURE RANGE</b>					
For Specified Performance		-40		+85	$^\circ\text{C}$

\*Pin 1 connected to Pin 4. See Applications section.

Specifications subject to change without notice.

### ABSOLUTE MAXIMUM RATINGS\*

Supply Voltage	±18 V
Internal Power Dissipation	650 mW
Input Voltage (Common-Mode)	±V <sub>S</sub>
Differential Input Voltage	±25 V
Output Short Circuit Duration	Indefinite
Storage Temperature	−65°C to +125°C
Operating Temperature Range	−40°C to +85°C
Lead Temperature Range (10 sec Soldering)	300°C

\*Stresses above those listed under Absolute Maximum Ratings may cause permanent damage to the device. This is a stress rating only and functional operation of the device at these or any other conditions above those indicated in the operational section of this specification is not implied. Exposure to absolute maximum rating conditions for extended periods may affect device reliability.

### PIN FUNCTION DESCRIPTIONS

Pin Number	Mnemonic	Function
1	NC	May be Connected to Pin 4 to Balance C <sub>IN</sub>
2	−IN	Inverting Input
3	+IN	Noninverting Input
4	−V <sub>S</sub>	Negative Supply Voltage
5	REF	Connect to Desired Output CMV
6	V <sub>OUT</sub>	Output
7	+V <sub>S</sub>	Positive Supply Voltage
8	NC	

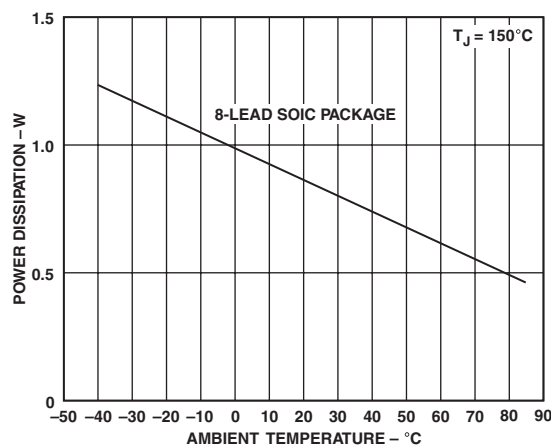

Figure 2. Maximum Power Dissipation vs. Temperature

### ORDERING GUIDE

Model	Temperature Range	Package Description	Package Options
AD8225AR	−40°C to +85°C	8-Lead SOIC	RN-8
AD8225AR-REEL	−40°C to +85°C	8-Lead SOIC	13" REEL
AD8225AR-REEL7	−40°C to +85°C	8-Lead SOIC	7" REEL
AD8225-EVAL		Evaluation Board	RN-8

### CAUTION

ESD (electrostatic discharge) sensitive device. Electrostatic charges as high as 4000 V readily accumulate on the human body and test equipment and can discharge without detection. Although the AD8225 features proprietary ESD protection circuitry, permanent damage may occur on devices subjected to high energy electrostatic discharges. Therefore, proper ESD precautions are recommended to avoid performance degradation or loss of functionality.



# AD8225—Typical Performance Characteristics ( $T_A = 25^\circ\text{C}$ , $R_L = 2\text{ k}\Omega$ , $V_S = \pm 15\text{ V}$ , unless otherwise noted.)

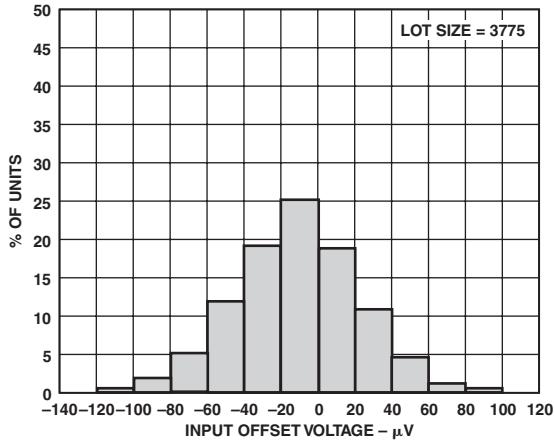

TPC 1. Typical Distribution of Input Offset Voltage,  $V_S = \pm 15\text{ V}$

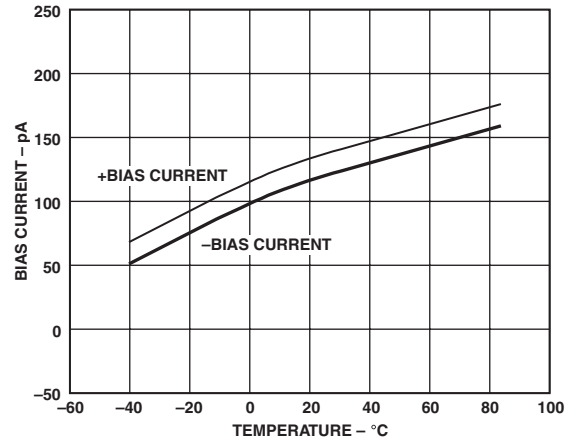

TPC 4. Bias Current vs. Temperature

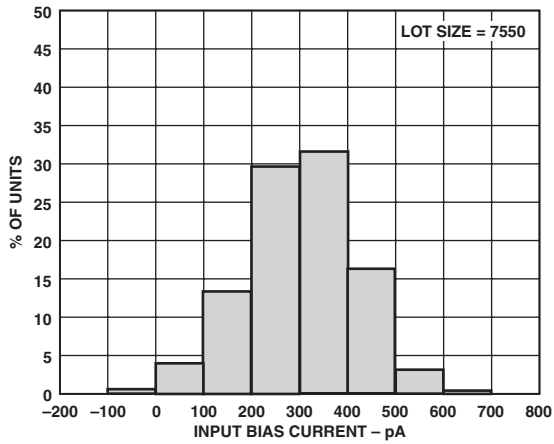

TPC 2. Typical Distribution of Input Bias Current,  $V_S = \pm 15\text{ V}$

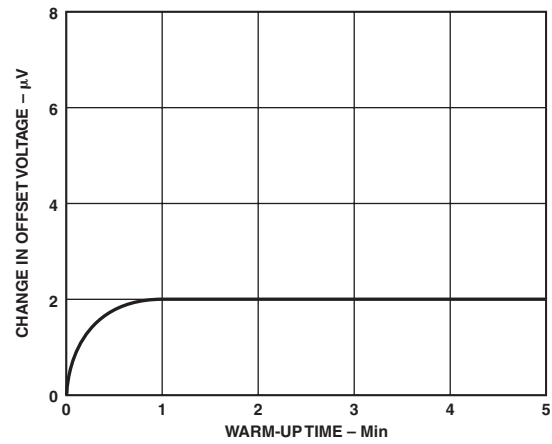

TPC 5. Offset Voltage vs. Warm-Up Time

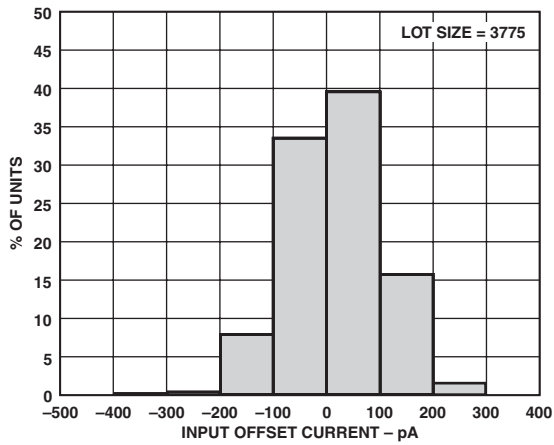

TPC 3. Typical Distribution of Input Offset Current,  $V_S = \pm 15\text{ V}$

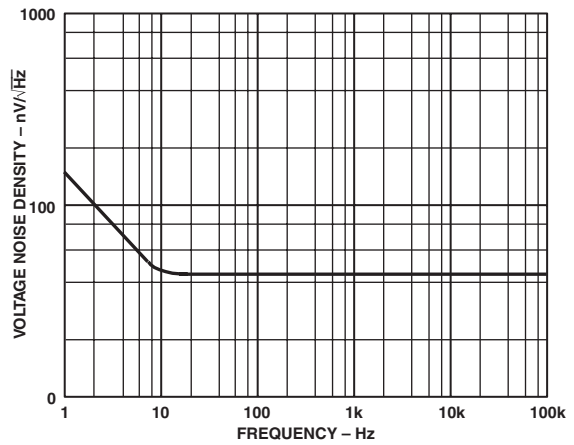

TPC 6. Voltage Noise Spectral Density vs. Frequency (RTI)

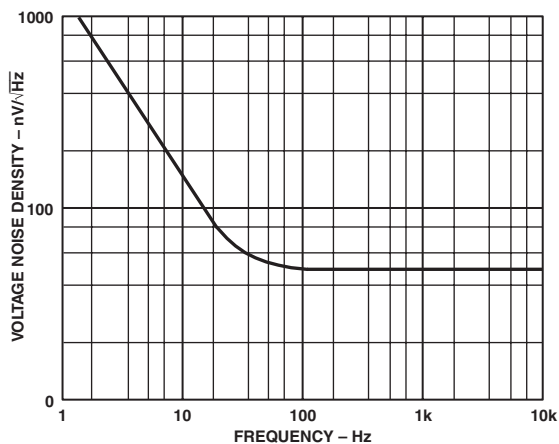

TPC 7. Input Current Noise Spectral Density vs. Frequency

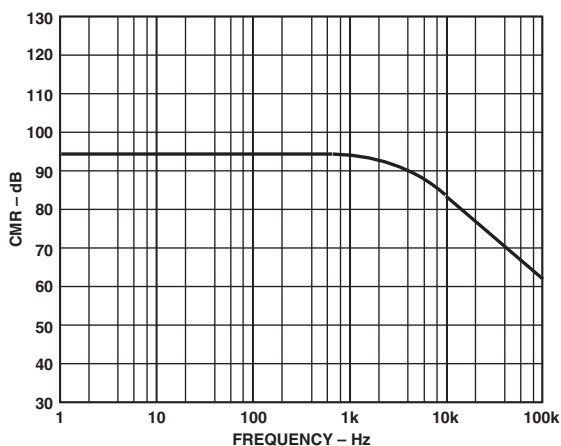

TPC 10. CMR vs. Frequency, RTI

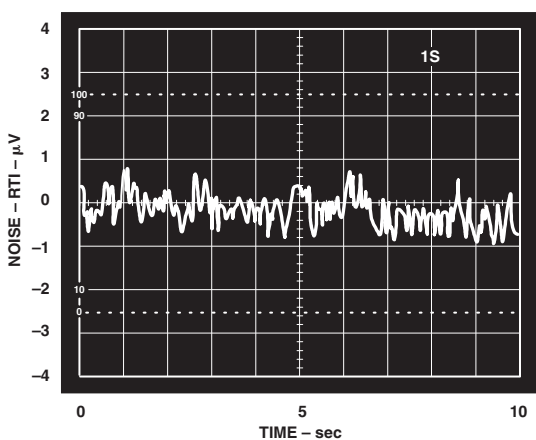

TPC 8. 0.1 Hz to 10 Hz Voltage Noise, RTI

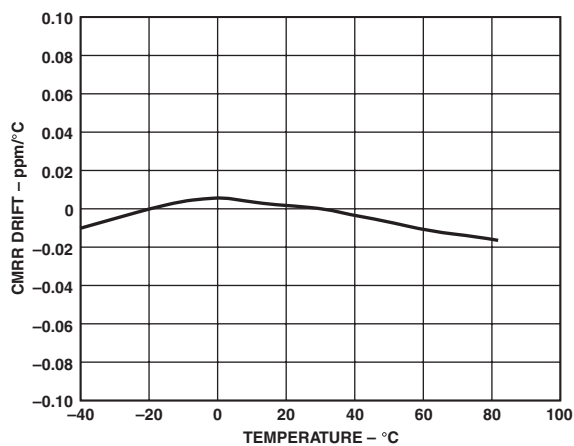

TPC 11. CMRR vs. Temperature

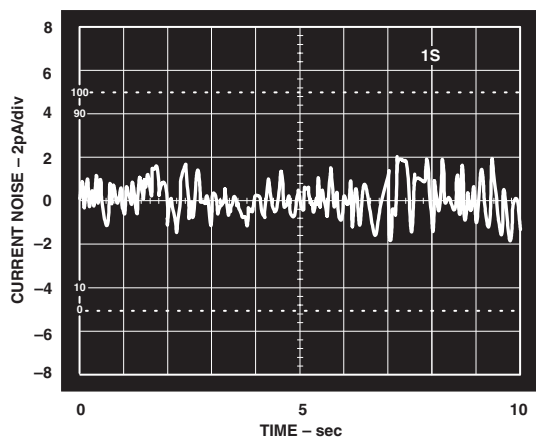

TPC 9. 0.1 Hz to 10 Hz Current Noise

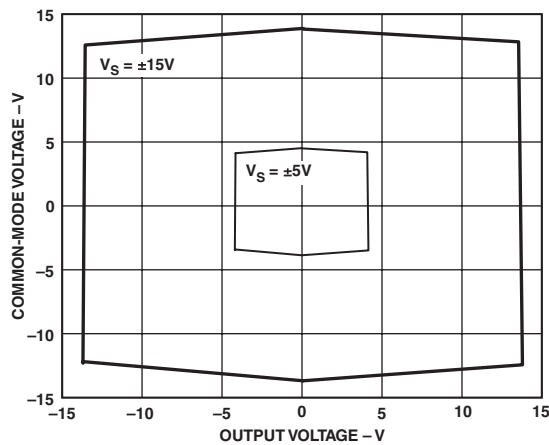

TPC 12. CMV Range vs.  $V_{OUT}$ , Dual Supplies

# AD8225

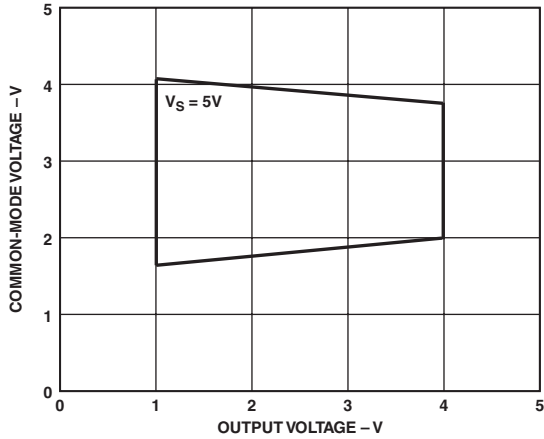

TPC 13. CMV vs.  $V_{OUT}$ , Single Supply

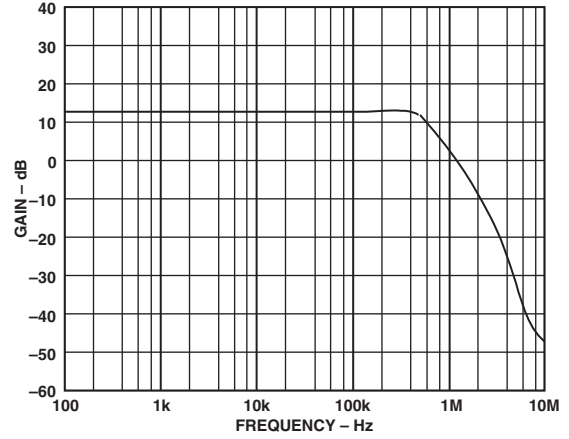

TPC 16. Large Signal Frequency Response,  $V_{OUT} = 4 V p-p$

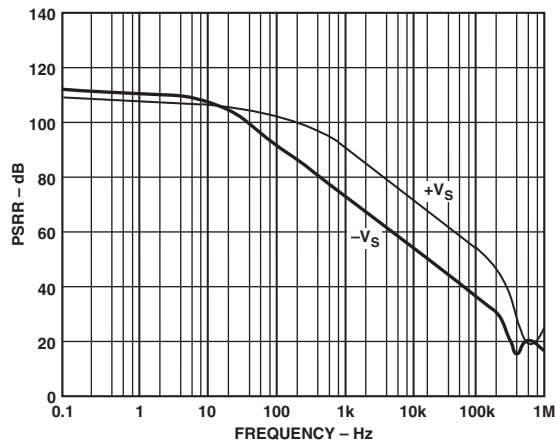

TPC 14. PSRR vs. Frequency, RTI

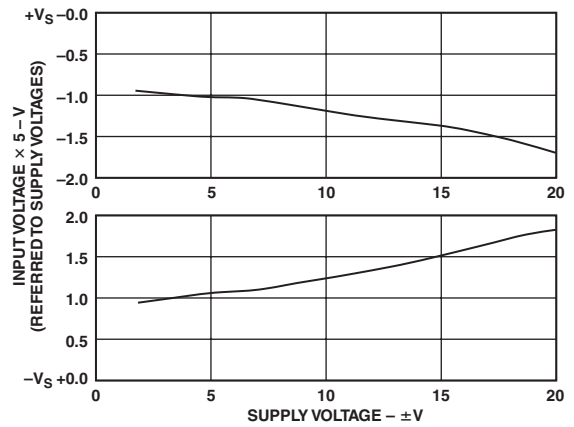

TPC 17. Input Common Mode Voltage Range vs. Supply Voltage

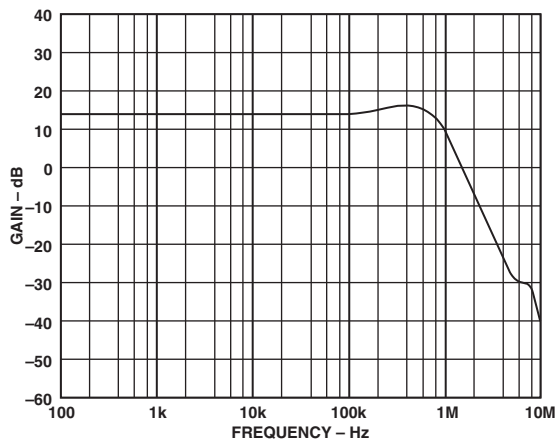

TPC 15. Small Signal Frequency Response,  $V_{OUT} = 200 mV p-p$

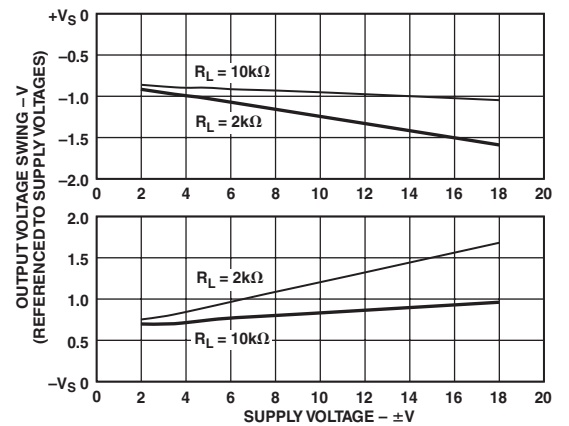

TPC 18. Output Voltage Swing vs. Supply Voltage and Load Resistance



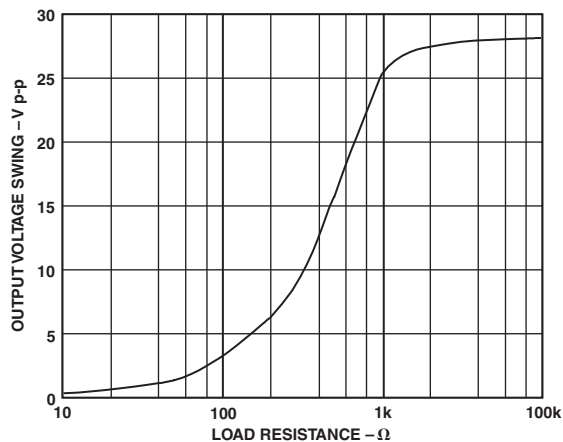

TPC 19. Output Voltage Swing vs. Load Resistance

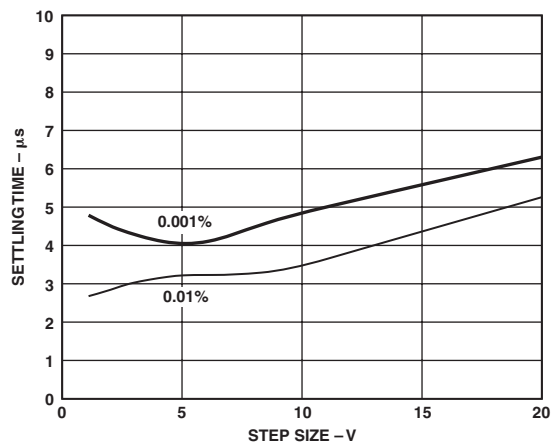

TPC 22. Settling Time vs. Step Size

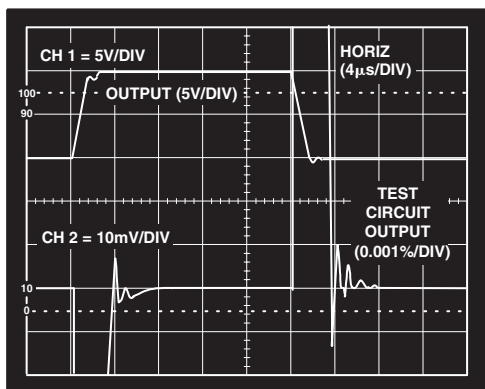

TPC 20. Large Signal Pulse Response and Settling Time to 0.001%

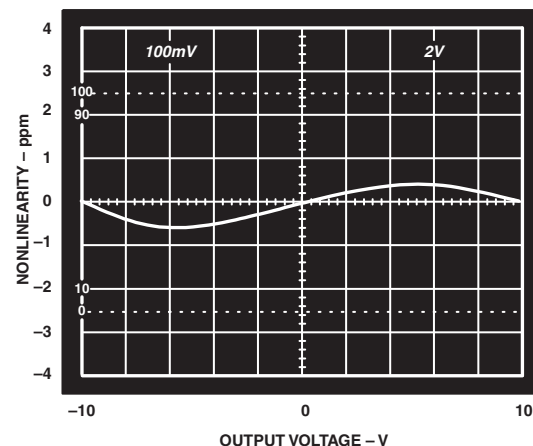

TPC 23. Gain Nonlinearity

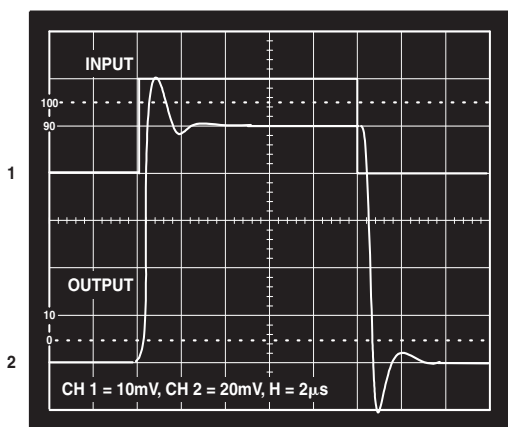

TPC 21. Small Signal Pulse Response,  $C_L = 100$  pF

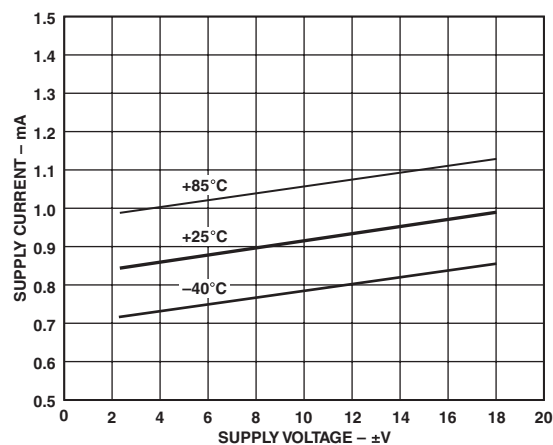

TPC 24.  $I_{SUPPLY}$  vs.  $V_{SUPPLY}$  and Temperature

# AD8225

## Test Circuits

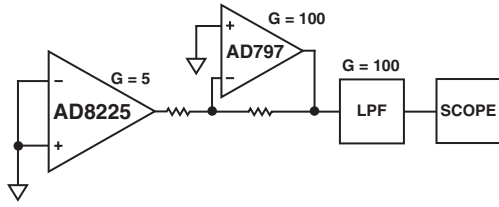

*Test Circuit 1. 1 Hz to 10 Hz Voltage Noise Test*

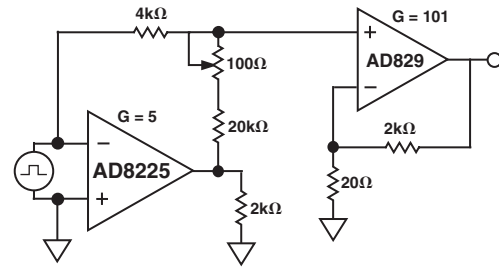

*Test Circuit 2. Settling Time to 0.01%*

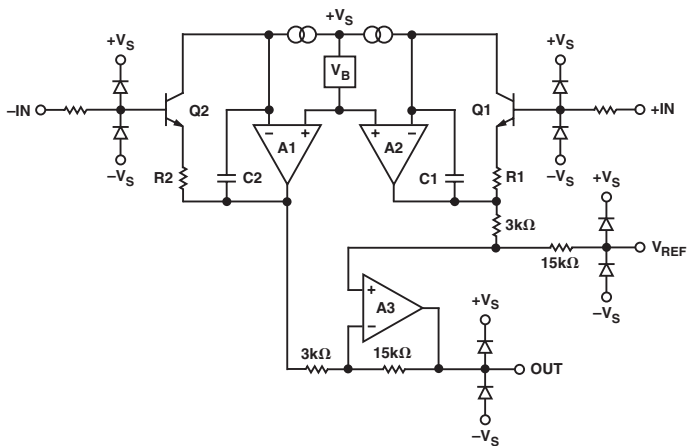

Figure 3. Simplified Schematic

**THEORY OF OPERATION**

The AD8225 is a monolithic, three op amp instrumentation amplifier. Laser wafer trimming and proprietary circuit techniques enable the AD8225 to boast the lowest output offset voltage and drift of any currently available in amp (150  $\mu$ V RTI), as well as a higher common-mode voltage range.

Referring to Figure 3, the input buffers consist of super-beta NPN transistors Q1 and Q2, and op amps A1 and A2. The transistors are compensated so that the bias currents are extremely low, typically 100 pA or less. As a result, current noise is also low, at 50 fA/ $\sqrt{\text{Hz}}$ . The unity gain input buffers drive a gain-of-five difference amplifier. Because the 3 k $\Omega$  and 15 k $\Omega$  resistors are ratio matched, gain stability is better than 5 ppm/ $^{\circ}\text{C}$  over the rated temperature range.

The AD8225 also has five times the gain bandwidth of a typical in amp. This wider GBW results from compensation at a fixed gain of 5, which can be one fifth of that required if the amplifier were compensated for unity gain.

High frequency performance is also enhanced by the innovative pinout of the AD8225. Since Pins 1 and 8 are uncommitted, Pin 1 may be connected to Pin 4. Since Pin 4 is also ac common, the stray capacitance at Pins 2 and 3 is balanced.

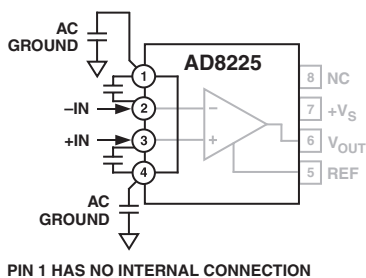

PIN 1 HAS NO INTERNAL CONNECTION

Figure 4. Pinout for Symmetrical Input Stray Capacitance

**APPLICATIONS**

**Precision V-to-I Converter**

When small analog voltages are transmitted across significant distances, errors may develop due to ambient electrical noise, stray capacitance, or series impedance effects. If the desired voltage is converted to a current, however, the effects of ambient noise are mitigated. All that is required is a voltage to current conversion at the source, and an I-to-V conversion at the other end to reverse the process.

Figure 5 illustrates how the AD8225 may be used as the transmitter and receiver in a current loop system. The full-scale output is 5 mA.

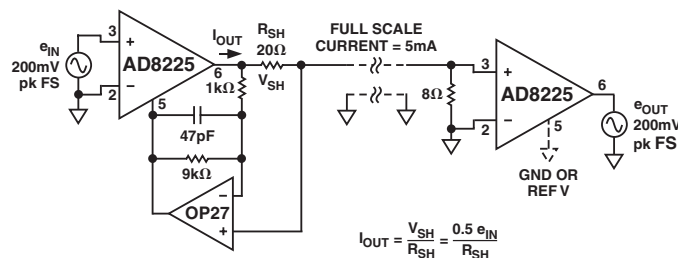

Figure 5. Precision Voltage-to-Current Converter

As noted in Figure 5, an additional op amp and four resistors are required to complete the converter. The precision gain of 5 in the AD8225s, used in the transmit and receive sections, preserves the integrity of the desired signal, while the high frequency common-mode performance at the receiver rejects noise on the transmission line. The reference of the receiver may be connected to local ground or the reference pin of an A/D converter (ADC).

Figure 6 shows bench measurements of the input and output voltages, and output current of the circuit of Figure 5. The transmission media is 10 feet of insulated hook-up wire for the current drive and return lines.

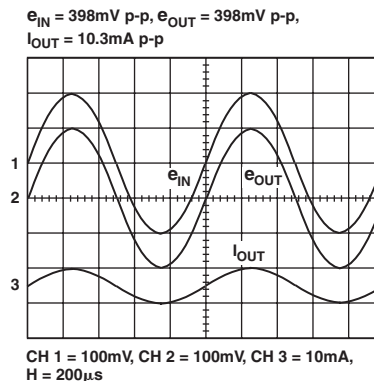

Figure 6. V-to-I Converter Waveforms (CH1:  $V_{IN}$ , CH2:  $V_{OUT}$ , CH3:  $I_{OUT}$ )

# AD8225

## Driving a High Resolution ADC

Most high precision ADCs feature differential analog inputs. Differential inputs offer an inherent 6 dB improvement in S/N ratio and resultant bit resolution. These advantages are easy to realize using a pair of AD8225s.

AD8225s can be configured to drive an ADC with differential inputs by using either single-ended or differential inputs to the AD8225s. Figure 7 shows the circuit connections for a differential input. A single-ended input may be configured by connecting the negative input terminal to ground.

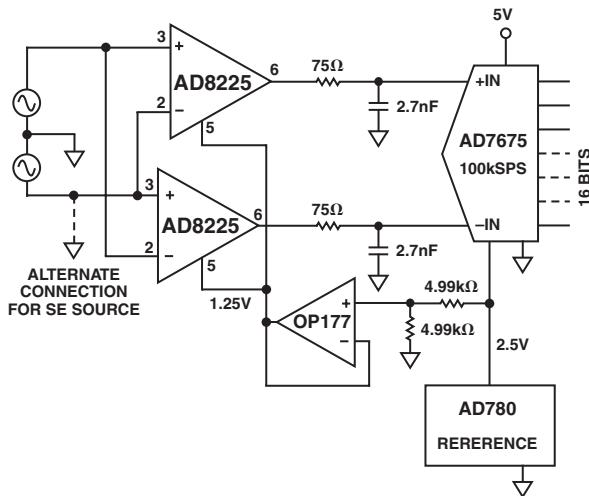

Figure 7. Driver for Differential ADC

The AD7675 ADC illustrated in Figure 7 is a SAR type converter. When the input is sampled, the internal sample-and-hold capacitor is charged to the input voltage level. Since the output of the AD8225 cannot track the instantaneous current surge, a voltage glitch develops. To source the momentary current surge, a capacitor is connected from the A/D input terminal to ground. Since the AD8225 cannot tolerate greater than approximately

100 pF of capacitance at its output, a 75 Ω series resistor is required at each in amp output to prevent oscillation.

## Using the Reference Input

Note in the example in Figure 7 that Pin 5, the reference input, is driven by a voltage source. This is because the reference pin is internally connected to a 15 kΩ resistor, which is carefully trimmed to optimize common-mode rejection. Any additional resistance connected to this node will unbalance the bridge network formed by the two 3 kΩ and two 15 kΩ resistors, resulting in an error voltage generated by common-mode voltages at the input pins.

## AD8225 Used as an EKG Front End

The topology of the instrumentation amplifier has made it the circuit configuration of choice for designers of EKG and other low level biomedical amplifiers. CMRR and common-mode voltage advantages of the instrumentation amplifier are tailor made to meet the challenges of detecting minuscule cardiac generated voltage levels in the presence of overwhelming levels of noise and dc offset voltage. The subtracter circuit of the in amp will extract and amplify low level signals that are virtually obscured by the presence of high common-mode dc and ac potentials.

A typical circuit block diagram of an EKG amplifier is shown in Figure 8. Using discrete op amps in the in amp and gain stages, the signal chain usually includes several filters, high voltage protection, lead-select circuitry, patient lead buffering, and an ADC. Designers who roll their own instrumentation amplifiers must provide precision custom trimmed resistor networks and well matched op amps.

The AD8225 instrumentation amplifier not only replaces all the components shown in the highlighted block in Figure 8, but also provides a solution to many of the difficult design problems encountered in EKG front ends. Among these are patient generated errors from ac noise sources and errors generated by unequal electrode potentials. Alone, these error voltages can exceed the desired QRS complex by orders of magnitude.

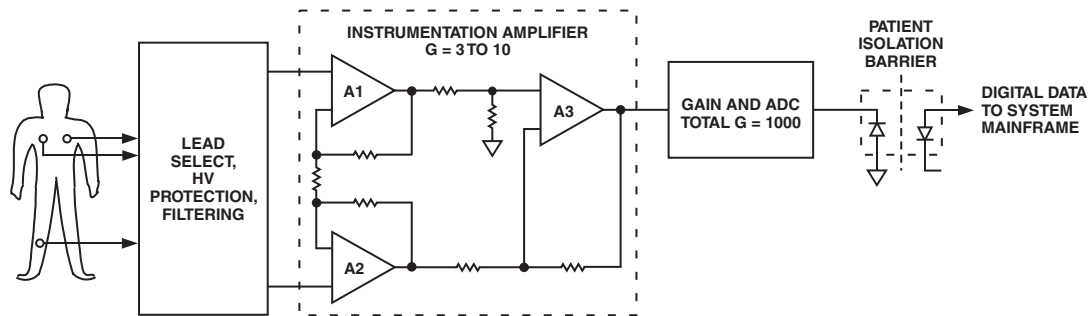

Figure 8. Block Diagram, EKG Monitor Front End Using Discrete Components

In the classical three op amp in amp topology shown in Figure 8, gain is developed differentially between the two input amplifiers A1 and A2, sacrificing CMV (common-mode voltage) range. The gain of the in amp is typically 10 or less, and an additional gain stage increases the overall gain to approximately 1000.

Gain developed in the input stage results in a trade-off in common-mode voltage range, constraining the ability of the amplifier to tolerate high dc electrode errors. Although the AD8225 is also a three amplifier design, its gain of 5 is developed at the *output* amplifier, improving the CMV range at the input. Using  $\pm 5$  V supplies, the CMV range of the AD8225 is from  $-3.4$  V to  $+4$  V, compared to  $-3.1$  V to  $+3.8$  V, a 7% improvement in input headroom over conventional in amps with the same gain.

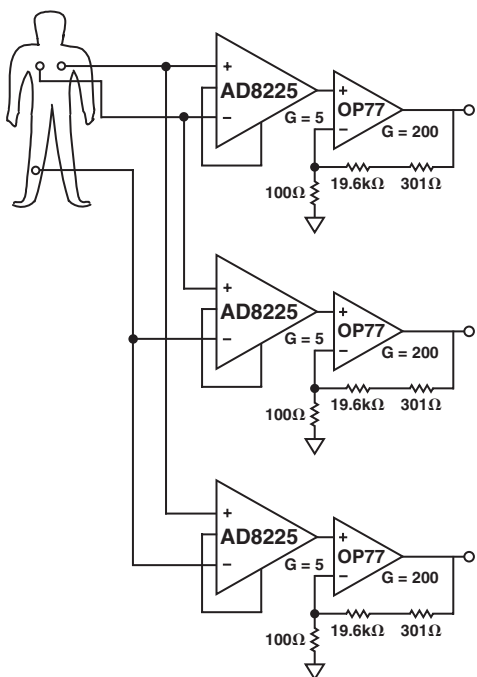

Figure 9. EKG Monitor Front End

Figure 9 illustrates how an AD8225 may be used in an EKG front end. In a low cost system, the AD8225 can be connected to the patient. If buffers are required, the AD8225 can replace the expensive precision resistor network and op amp.

Figure 10 shows test waveforms observed from the circuit of Figure 9.

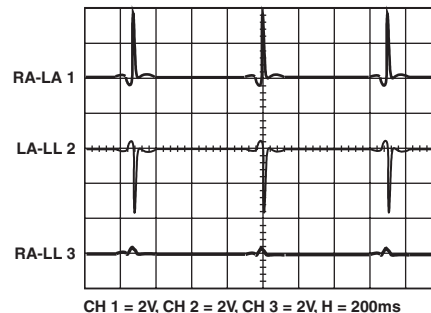

Figure 10. EKG Waveform Using Circuit of Figure 9

### Benefits of Fast Slew Rates

At  $5$  V/ $\mu$ s, the slew rate of the AD8225 is as fast as many op amp circuits. This is an advantage in systems applications using multiple sensors. For example, an analog multiplexer (see Figure 11) may be used to select pairs of leads connected to several sensors. If the AD8225 drives an ADC, the acquisition time is constrained by the ability of the in amp to settle to a stable level after a new set of leads is selected. Fast slew rates contribute greatly to this function, especially if the difference in input levels is large.

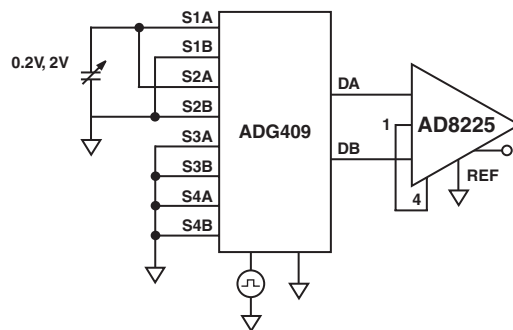

Figure 11. Connection to an ADG409 Analog MUX

Figure 12 illustrates the response of an AD8225 connected to an ADG409 analog multiplexer in the circuit shown in Figure 11 at two signal levels. Two of the four MUX inputs are connected to test dc levels. The remaining two are at ground potential so that the output slews as the inputs A0 and A1 are addressed. As can be seen, the output response settles well within  $4$   $\mu$ s of the applied level.

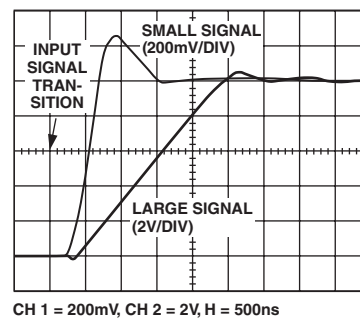

Figure 12. Slew Responses After MUX Selection



OUTLINE DIMENSIONS

8-Lead Standard Small Outline Package (SOIC)  
(RN-8)

Dimensions shown in millimeters and (inches)

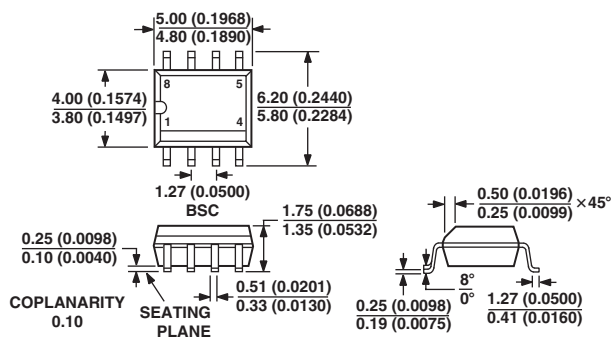

COMPLIANT TO JEDEC STANDARDS MS-012AA  
CONTROLLING DIMENSIONS ARE IN MILLIMETERS; INCH DIMENSIONS  
(IN PARENTHESES) ARE ROUNDED-OFF MILLIMETER EQUIVALENTS FOR  
REFERENCE ONLY AND ARE NOT APPROPRIATE FOR USE IN DESIGN

# AD8225

## Revision History

Location	Page
<b>2/03—Data Sheet changed from REV. 0 to REV. A.</b>	
Updated ORDERING GUIDE .....	5
Change to TPC 10 .....	7
Change to TPC 20 caption .....	9
Edit to Precision V-to-I Converter section .....	11
OUTLINE DIMENSIONS updated .....	15

C02771-0-2/03(A)

PRINTED IN U.S.A.



## X-ON Electronics

Largest Supplier of Electrical and Electronic Components

*Click to view similar products for [Instrumentation Amplifiers](#) category:*

*Click to view products by [Analog Devices](#) manufacturer:*

Other Similar products are found below :

[ADA4254RU-EBZ](#) [MCP6N16-001E/MF](#) [LT1102IN8#PBF](#) [AD694BRZ-REEL7](#) [LT1101ISW](#) [AD521JDZ](#) [AD521KDZ](#) [AD521LDZ](#)  
[AD524ADZ](#) [AD524BDZ](#) [AD524CDZ](#) [AD620ANZ](#) [AD621BNZ](#) [AD621BR](#) [AD622ANZ](#) [AD623ANZ](#) [AD623BNZ](#) [AD624ADZ](#)  
[AD624CDZ](#) [AD624SD/883B](#) [AD625ADZ](#) [AD625BDZ](#) [AD625JNZ](#) [AD625KNZ](#) [AD625SD](#) [AD627BNZ](#) [AD693AD](#) [AD693AE](#) [AD693AQ](#)  
[AD694AQ](#) [AD694ARZ-REEL](#) [AD694BRZ-REEL](#) [AD694JNZ](#) [AD8221ARMZ-R7](#) [AD8224BCPZ-WP](#) [AD8224HBCPZ-WP](#)  
[AD8226ARMZ-R7](#) [AD8228ARMZ](#) [AD8228ARMZ-R7](#) [AD8229HDZ](#) [AD8236ARMZ-R7](#) [AD8237ARMZ-R7](#) [AD8253ARMZ](#)  
[AD8293G160BRJZ-R7](#) [AD8293G80BRJZ-R2](#) [AD8553ARMZ](#) [AD8553ARMZ-REEL](#) [AD8555ACPZ-REEL7](#) [AD8556ACPZ-R2](#)  
[AD8556ACPZ-REEL7](#)