

FEATURES

- Offset voltage: 2.2 mV maximum**
- Low input bias current: 1 pA maximum**
- Single-supply operation: 1.8 V to 5.5 V**
- Low noise: 22 nV/ $\sqrt{\text{Hz}}$**
- Micropower: 50 μA /amplifier maximum over temperature**
- No phase reversal**
- Unity gain stable**
- Qualified for automotive applications**

APPLICATIONS

- Battery-powered instrumentation**
- Multipole filters**
- Current shunt sense**
- Sensors**
- ADC predrivers**
- DAC drivers/level shifters**
- Low power ASIC input or output amplifiers**

GENERAL DESCRIPTION

The [AD8613/AD8617/AD8619](#) are single, dual, and quad micro-power, rail-to-rail input and output amplifiers that feature low supply current, as well as low input voltage and current noise.

The parts are fully specified to operate from 1.8 V to 5 V single supply, or ± 0.9 V and ± 2.5 V dual supply. The combination of low noise, very low input bias currents, and low power consumption make the [AD8613/AD8617/AD8619](#) especially useful in portable and loop-powered instrumentation.

The ability to swing rail-to-rail at both the input and output enables designers to buffer CMOS ADCs, DACs, ASICs, and other wide output swing devices in low power, single-supply systems.

The [AD8613](#) is available in a 5-lead SC70 package and a 5-lead TSOT-23 package. The [AD8617](#) is available in 8-lead MSOP, 8-lead SOIC, and 8-lead LFCSP packages. The [AD8619](#) is available in 14-lead TSSOP and 14-lead SOIC packages. The [AD8617W](#) is qualified for automotive applications and is available in 8-lead MSOP and 8-lead SOIC packages. The [AD8619W](#) is qualified for automotive applications and is available in 14-lead SOIC and 14-lead TSSOP packages.

PIN CONFIGURATIONS

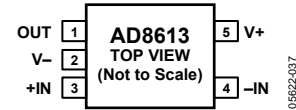

Figure 1. 5-Lead SC70 and 5-Lead TSOT-23

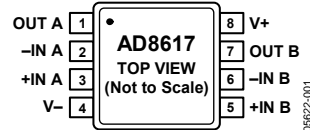
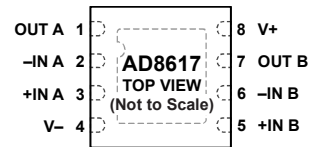

Figure 2. 8-Lead MSOP and 8-Lead SOIC_N



NOTES

1. PIN 4 AND THE EXPOSED PAD MUST BE CONNECTED TO V-.

Figure 3. 8-Lead LFCSP

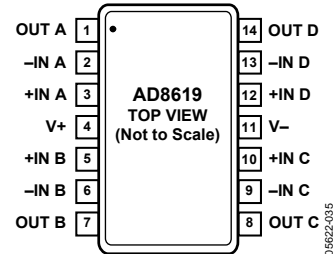

Figure 4. 14-Lead TSSOP and 14-Lead SOIC

TABLE OF CONTENTS

Features	1
Applications.....	1
General Description	1
Pin Configurations	1
Revision History	2
Specifications.....	3
Absolute Maximum Ratings.....	5

REVISION HISTORY

5/2016—Rev. G to Rev. H

Changed CP-8-9 to CP-8-21	Throughout
Changed LFCSP_VD to LFCSP.....	Throughout
Changes to Figure 3.....	1
Changes to Table 4.....	5
Changes to Figure 43.....	15
Updated Outline Dimensions.....	15
Changes to Ordering Guide	15

12/2014—Rev. F to Rev. G

Changes to General Description Section	1
Changes to Ordering Guide	15

4/2014—Rev. E to Rev. F

Changes to General Description Section	1
Changes to Table 3.....	5
Changes to Ordering Guide	15
Added Automotive Products Section	15

3/2010—Rev. D to Rev. E

Changes to General Description	1
Changes to Ordering Guide	15

3/2010—Rev. C to Rev. D

Changes to General Description	1
Changes to Ordering Guide	15

10/2009—Rev. B to Rev. C

Added 8-Lead LFCSP Package.....	Universal
Changes to Features Section, Figure 2 Caption, General Description Section, and Figure 3.....	1
Changed V_S to V_{SY} Throughout.....	3

Thermal Resistance	5
ESD Caution.....	5
Typical Performance Characteristics	6
Outline Dimensions	12
Ordering Guide	15
Automotive Products.....	16

Changes to Input Characteristics, Input Voltage Range Parameter; Dynamic Performance, Settling Time to 0.1% and Phase Margin Parameters; and Noise Performance, Peak-to-Peak Noise Parameter, Table 1	3
Changes to Input Characteristics, Input Voltage Range Parameter; Dynamic Performance, Settling Time to 0.1% and Phase Margin Parameters; and Noise Performance, Peak-to-Peak Noise Parameter, Table 2	4
Changes to Table 3 and Table 4	5
Changes to Figure 12 to Figure 15	7
Changes to Figure 18 Caption	8
Changes to Figure 30 and Figure 31	10
Updated Outline Dimensions.....	12
Added Figure 44; Renumbered Sequentially	14
Changes to Ordering Guide	15

1/2006—Rev. A to Rev. B

Added AD8613.....	Universal
Changes to Features	1
Changes to Table 1.....	3
Changes to Table 2.....	4
Updated Outline Dimensions.....	12
Changes to Ordering Guide	13

10/2005—Rev. 0 to Rev. A

Added AD8619.....	Universal
Change to Specifications Section	3
Updated Outline Dimensions.....	12
Changes to Ordering Guide	13

9/2005—Revision 0: Initial Version

SPECIFICATIONS

Electrical characteristics at $V_{SY} = 5\text{ V}$, $V_{CM} = V_{SY}/2$, $T_A = 25^\circ\text{C}$, unless otherwise noted.

Table 1.

Parameter	Symbol	Conditions	Min	Typ	Max	Unit	
INPUT CHARACTERISTICS							
Offset Voltage	V_{OS}	$-0.3\text{ V} < V_{CM} < +5.3\text{ V}$ $-40^\circ\text{C} < T_A < +125^\circ\text{C}$, $-0.3\text{ V} < V_{CM} < +5.2\text{ V}$		0.4	2.2	mV	
Offset Voltage Drift	$\Delta V_{OS}/\Delta T$	$-40^\circ\text{C} < T_A < +125^\circ\text{C}$		1	4.5	$\mu\text{V}/^\circ\text{C}$	
AD8613 Input Bias Current	I_B	$-40^\circ\text{C} < T_A < +85^\circ\text{C}$ $-40^\circ\text{C} < T_A < +125^\circ\text{C}$		2.5	7.0	$\mu\text{V}/^\circ\text{C}$	
Input Offset Current	I_{OS}	$-40^\circ\text{C} < T_A < +85^\circ\text{C}$ $-40^\circ\text{C} < T_A < +125^\circ\text{C}$		0.2	1	pA	
						110	pA
						780	pA
Input Voltage Range Common-Mode Rejection Ratio	IVR	$0\text{ V} < V_{CM} < 5\text{ V}$ $-40^\circ\text{C} < T_A < +125^\circ\text{C}$	0		5	V	
	CMRR			95		dB	
			68			dB	
Large Signal Voltage Gain	A_{VO}	$R_L = 10\text{ k}\Omega$, $0.5\text{ V} < V_O < 4.5\text{ V}$	235	500		V/mV	
Input Capacitance	C_{DIFF}			1.9		pF	
	C_{CM}			2.5		pF	
OUTPUT CHARACTERISTICS							
Output Voltage High	V_{OH}	$I_L = 1\text{ mA}$ -40°C to $+125^\circ\text{C}$	4.95	4.98		V	
			4.9			V	
				4.7		V	
Output Voltage Low	V_{OL}	$I_L = 10\text{ mA}$ -40°C to $+125^\circ\text{C}$	4.50			V	
				$I_L = 1\text{ mA}$ -40°C to $+125^\circ\text{C}$	20	30	mV
				$I_L = 10\text{ mA}$ -40°C to $+125^\circ\text{C}$		50	mV
				$I_L = 10\text{ mA}$ -40°C to $+125^\circ\text{C}$	190	275	mV
Short-Circuit Current	I_{SC}				335	mV	
Closed-Loop Output Impedance	Z_{OUT}	$f = 10\text{ kHz}$, $A_V = 1$		± 80		mA	
				15		Ω	
POWER SUPPLY							
Power Supply Rejection Ratio	PSRR	$1.8\text{ V} < V_{SY} < 5\text{ V}$ $-40^\circ\text{C} < T_A < +125^\circ\text{C}$	67	94		dB	
			64			dB	
Supply Current/Amplifier	I_{SY}	$V_O = V_{SY}/2$ $-40^\circ\text{C} < T_A < +125^\circ\text{C}$		38		μA	
					50	μA	
DYNAMIC PERFORMANCE							
Slew Rate	SR	$R_L = 10\text{ k}\Omega$		0.1		V/ μs	
Settling Time to 0.1%	t_s	$G = \pm 1$, $V_{IN} = 2\text{ V}$ step, $C_L = 20\text{ pF}$, $R_L = 1\text{ k}\Omega$		23		μs	
Gain Bandwidth Product	GBP	$R_L = 100\text{ k}\Omega$		400		kHz	
					350		kHz
Phase Margin	ϕ_M	$R_L = 10\text{ k}\Omega$, $R_L = 100\text{ k}\Omega$, $C_L = 20\text{ pF}$		70		Degrees	
NOISE PERFORMANCE							
Peak-to-Peak Noise	e_n p-p	0.1 Hz to 10 Hz		2.3	3.5	μV	
Voltage Noise Density	e_n	$f = 1\text{ kHz}$		25		nV/ $\sqrt{\text{Hz}}$	
		$f = 10\text{ kHz}$		22		nV/ $\sqrt{\text{Hz}}$	
Current Noise Density	i_n	$f = 1\text{ kHz}$		0.05		pA/ $\sqrt{\text{Hz}}$	

Electrical characteristics at $V_{SY} = 1.8\text{ V}$, $V_{CM} = V_{SY}/2$, $T_A = 25^\circ\text{C}$, unless otherwise noted.

Table 2.

Parameter	Symbol	Conditions	Min	Typ	Max	Unit
INPUT CHARACTERISTICS						
Offset Voltage	V_{OS}	$-0.3\text{ V} < V_{CM} < +1.9\text{ V}$ $-0.3\text{ V} < V_{CM} < +1.8\text{ V}; -40^\circ\text{C} < T_A < +125^\circ\text{C}$		0.4	2.2	mV
Offset Voltage Drift	$\Delta V_{OS}/\Delta T$	$-40^\circ\text{C} < T_A < +125^\circ\text{C}$		1	8.5	$\mu\text{V}/^\circ\text{C}$
Input Bias Current	I_B	$-40^\circ\text{C} < T_A < +85^\circ\text{C}$ $-40^\circ\text{C} < T_A < +125^\circ\text{C}$		0.2	1	pA
Input Offset Current	I_{OS}	$-40^\circ\text{C} < T_A < +85^\circ\text{C}$ $-40^\circ\text{C} < T_A < +125^\circ\text{C}$		0.1	0.5	pA
Input Voltage Range	IVR		0		1.8	V
Common-Mode Rejection Ratio	CMRR	$0\text{ V} < V_{CM} < 1.8\text{ V}$ $-40^\circ\text{C} < T_A < +125^\circ\text{C}$	58	86		dB
Large Signal Voltage Gain	A_{VO}	$R_L = 10\text{ k}\Omega$, $0.5\text{ V} < V_O < 1.3\text{ V}$	85	1000		V/mV
Input Capacitance	C_{DIFF} C_{CM}			2.1		pF
				3.8		pF
OUTPUT CHARACTERISTICS						
Output Voltage High	V_{OH}	$I_L = 1\text{ mA}$ -40°C to $+125^\circ\text{C}$	1.65	1.73		V
Output Voltage Low	V_{OL}	$I_L = 1\text{ mA}$ -40°C to $+125^\circ\text{C}$		44	60	mV
Short-Circuit Current	I_{SC}			± 7	80	mV
Closed-Loop Output Impedance	Z_{OUT}	$f = 10\text{ kHz}$, $A_V = 1$		15		Ω
POWER SUPPLY						
Power Supply Rejection Ratio	PSRR	$1.8\text{ V} < V_S < 5\text{ V}$	67	94		dB
Supply Current/Amplifier	I_{SY}	$V_O = V_{SY}/2$ $-40^\circ\text{C} < T_A < +125^\circ\text{C}$		38		μA
					50	μA
DYNAMIC PERFORMANCE						
Slew Rate	SR	$R_L = 10\text{ k}\Omega$		0.1		V/ μs
Settling Time to 0.1%	t_s	$G = \pm 1$, $V_{IN} = 1\text{ V}$ step, $C_L = 20\text{ pF}$, $R_L = 1\text{ k}\Omega$		6.5		μs
Gain Bandwidth Product	GBP	$R_L = 100\text{ k}\Omega$		400		kHz
Phase Margin	ϕ_M	$R_L = 10\text{ k}\Omega$ $R_L = 10\text{ k}\Omega$, $R_L = 100\text{ k}\Omega$, $C_L = 20\text{ pF}$		350		kHz
				70		Degrees
NOISE PERFORMANCE						
Peak-to-Peak Noise	e_n p-p	0.1 Hz to 10 Hz		2.3	3.5	μV
Voltage Noise Density	e_n	$f = 1\text{ kHz}$ $f = 10\text{ kHz}$		25		nV/ $\sqrt{\text{Hz}}$
Current Noise Density	i_n	$f = 1\text{ kHz}$		0.05		pA/ $\sqrt{\text{Hz}}$

ABSOLUTE MAXIMUM RATINGS

$T_A = 25^\circ\text{C}$, unless otherwise noted.

Table 3.

Parameter	Rating
Supply Voltage	6 V
Input Voltage	$V_{SS} - 0.3\text{ V}$ to $V_{DD} + 0.3\text{ V}$
Input Current	$\pm 10\text{ mA}$
Differential Input Voltage	$\pm 6\text{ V}$
Output Short-Circuit Duration to GND	Indefinite
Storage Temperature Range	-65°C to $+150^\circ\text{C}$
Operating Temperature Range	-40°C to $+125^\circ\text{C}$
Junction Temperature Range	-65°C to $+150^\circ\text{C}$
Lead Temperature (Soldering, 60 sec)	300°C
ESD AD8613	
HBM	$\pm 4000\text{ V}$
FICDM	$\pm 1000\text{ V}$
ESD AD8617	
HBM	$\pm 3000\text{ V}$
FICDM	$\pm 1000\text{ V}$
MM	$\pm 100\text{ V}$
ESD AD8619	
HBM	$\pm 4000\text{ V}$
FICDM	$\pm 1250\text{ V}$
MM	$\pm 200\text{ V}$

Stresses at or above those listed under Absolute Maximum Ratings may cause permanent damage to the product. This is a stress rating only; functional operation of the product at these or any other conditions above those indicated in the operational section of this specification is not implied. Operation beyond the maximum operating conditions for extended periods may affect product reliability.

THERMAL RESISTANCE

θ_{JA} is specified for the worst-case conditions, that is, a device soldered in a circuit board for surface-mount packages.

Table 4. Thermal Characteristics

Package Type	θ_{JA}	θ_{JC}	Unit
5-Lead TSOT-23 (UJ-5)	207	61	$^\circ\text{C}/\text{W}$
5-Lead SC70 (KS-5)	376	126	$^\circ\text{C}/\text{W}$
8-Lead MSOP (RM-8)	210	45	$^\circ\text{C}/\text{W}$
8-Lead SOIC_N (R-8)	158	43	$^\circ\text{C}/\text{W}$
8-Lead LFCSP (CP-8-21)	81	20	$^\circ\text{C}/\text{W}$
14-Lead SOIC_N (R-14)	120	36	$^\circ\text{C}/\text{W}$
14-Lead TSSOP (RU-14)	180	35	$^\circ\text{C}/\text{W}$

ESD CAUTION



ESD (electrostatic discharge) sensitive device. Charged devices and circuit boards can discharge without detection. Although this product features patented or proprietary protection circuitry, damage may occur on devices subjected to high energy ESD. Therefore, proper ESD precautions should be taken to avoid performance degradation or loss of functionality.

TYPICAL PERFORMANCE CHARACTERISTICS

$V_{SY} = 5\text{ V}$ or $\pm 2.5\text{ V}$, unless otherwise noted.

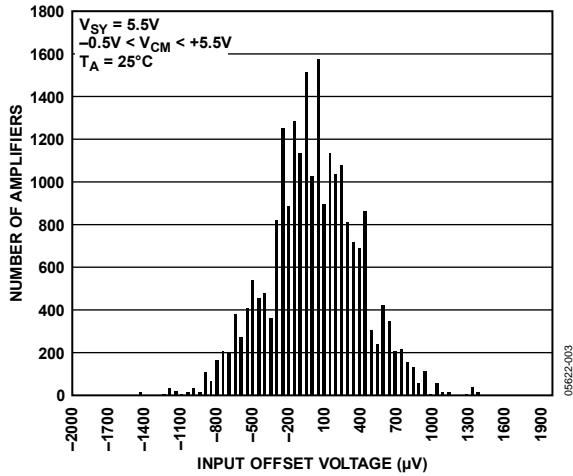

Figure 5. Input Offset Voltage Distribution

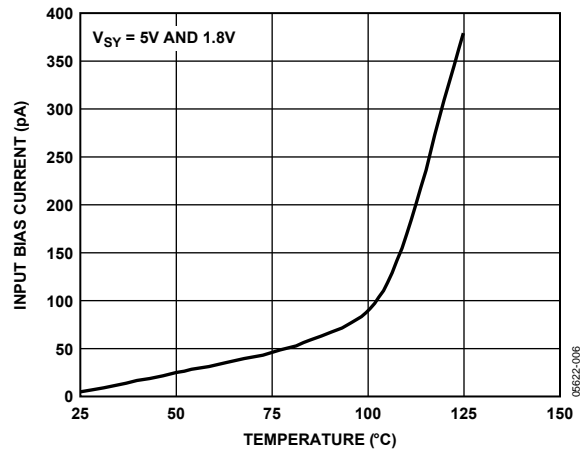

Figure 8. Input Bias Current vs. Temperature

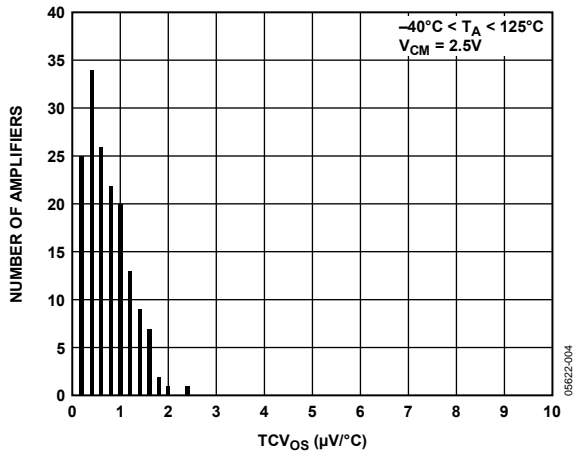

Figure 6. Input Offset Voltage Drift Distribution

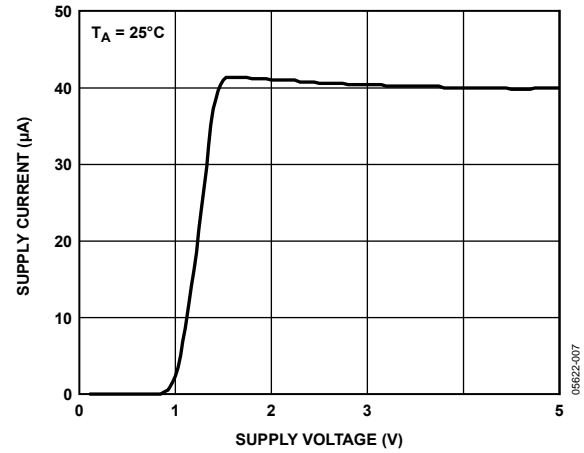

Figure 9. Supply Current vs. Supply Voltage

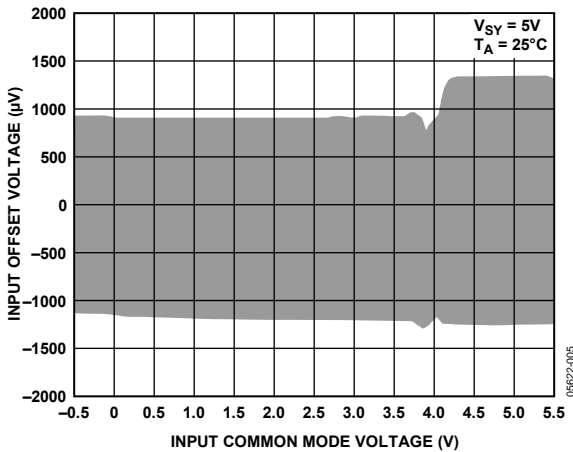

Figure 7. Input Offset Voltage vs. Input Common-Mode Voltage

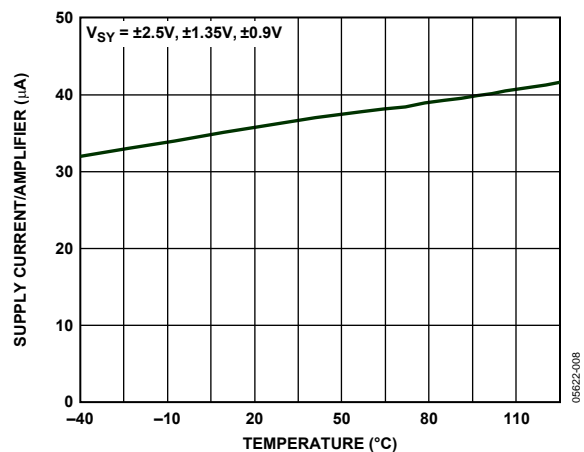

Figure 10. Supply Current vs. Temperature

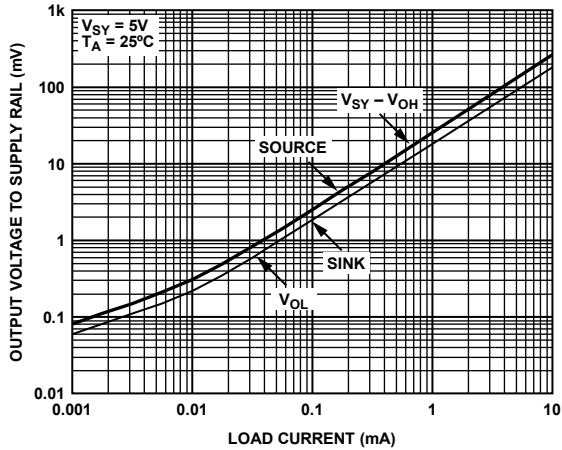

Figure 11. Output Voltage to Supply Rail vs. Load Current

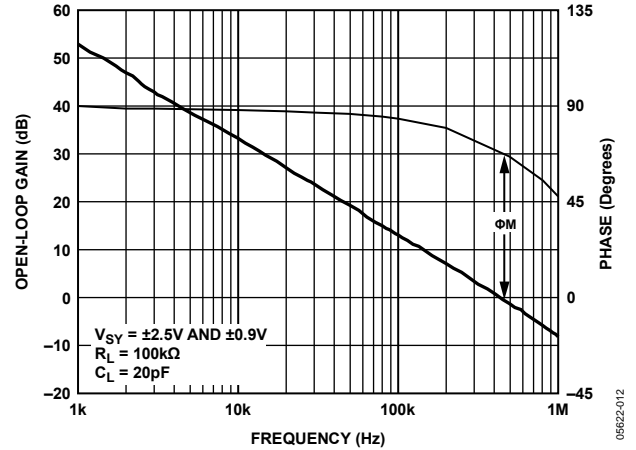

Figure 14. Open-Loop Gain and Phase vs. Frequency

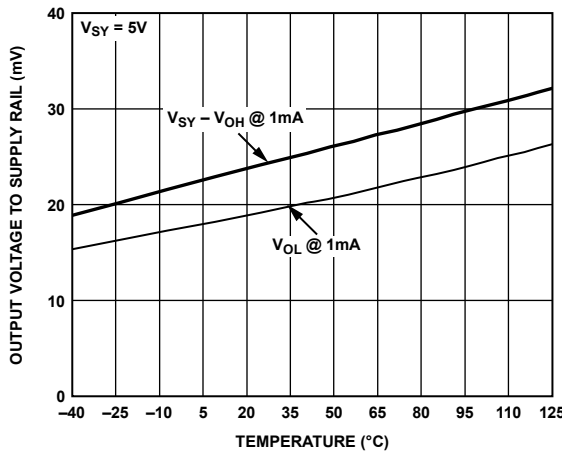

Figure 12. Output Voltage to Supply Rail vs. Temperature ($I_L = 1 \text{ mA}$)

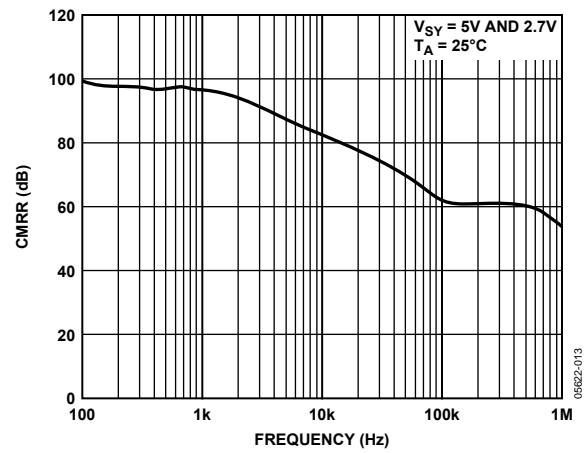

Figure 15. CMRR vs. Frequency

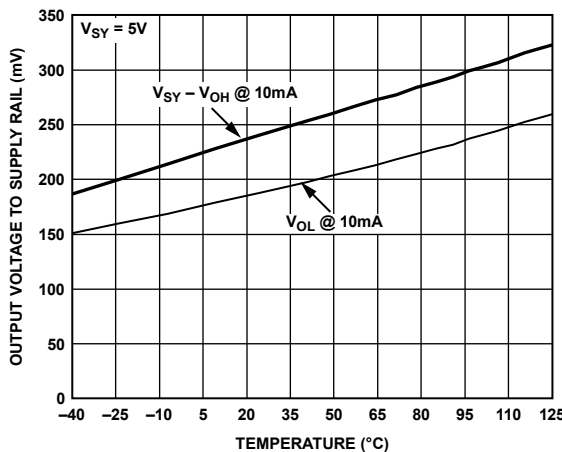

Figure 13. Output Voltage to Supply Rail vs. Temperature ($I_L = 10 \text{ mA}$)

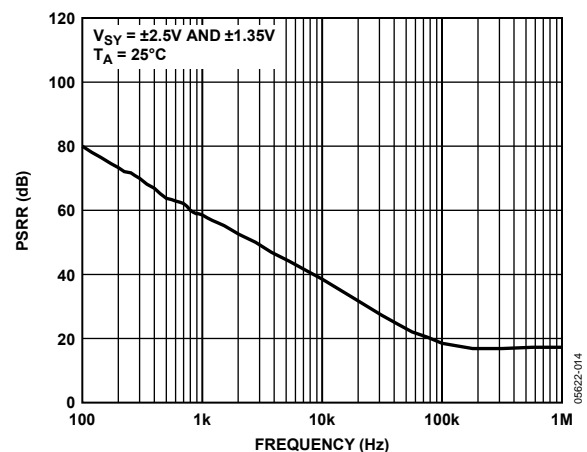

Figure 16. PSRR vs. Frequency

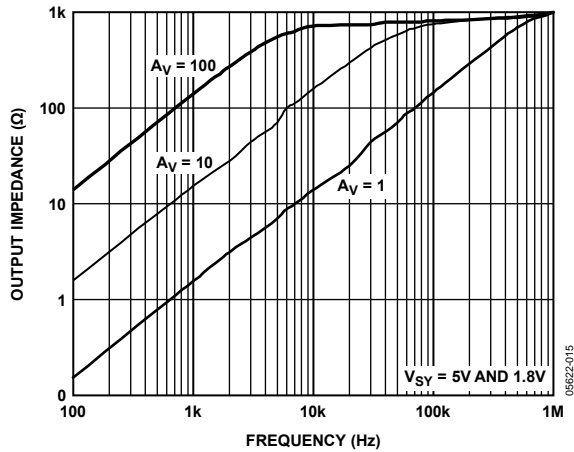

Figure 17. Output Impedance vs. Frequency

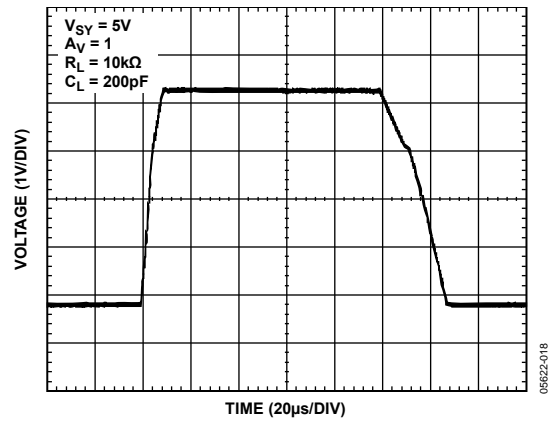

Figure 20. Large Signal Transient Response

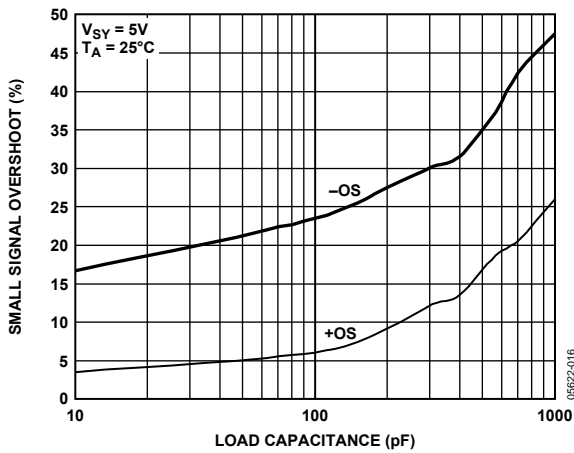

Figure 18. Small Signal Overshoot vs. Load Capacitance

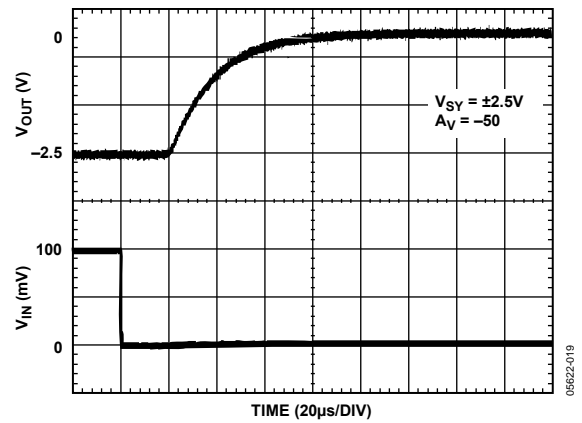

Figure 21. Positive Overload Recovery

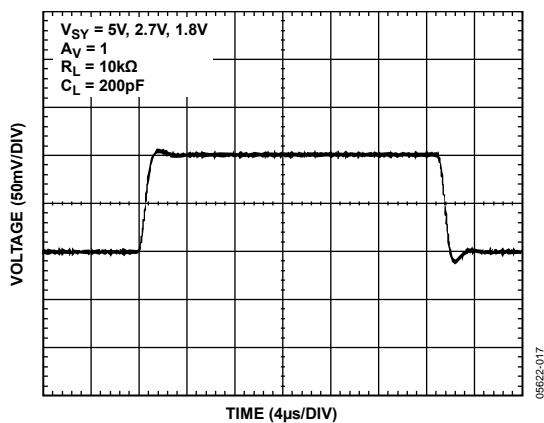

Figure 19. Small Signal Transient Response

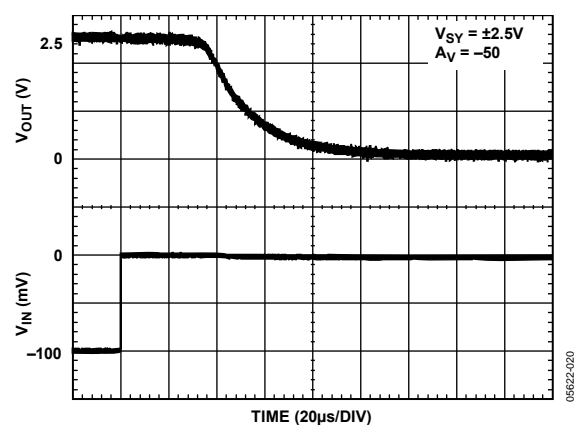

Figure 22. Negative Overload Recovery

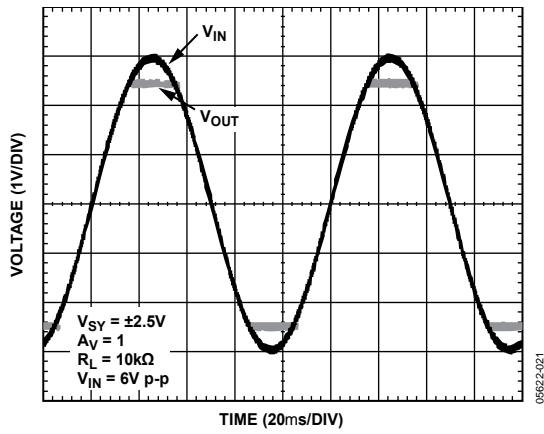

Figure 23. No Phase Reversal

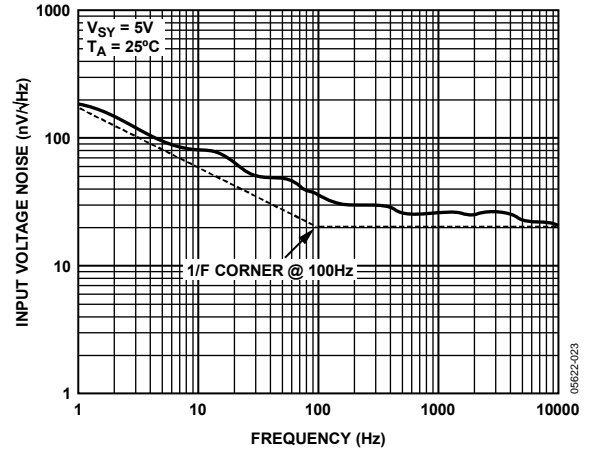

Figure 25. Voltage Noise Density

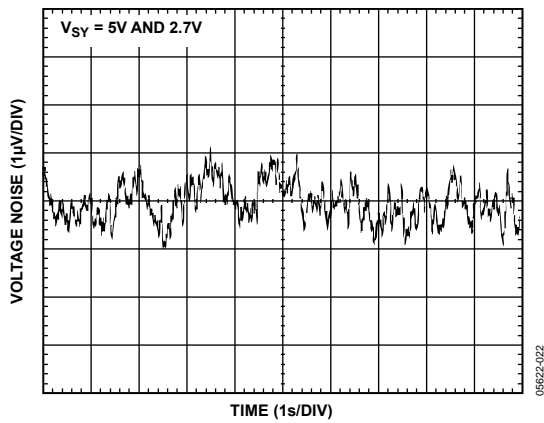

Figure 24. 0.1 Hz to 10 Hz Input Voltage Noise

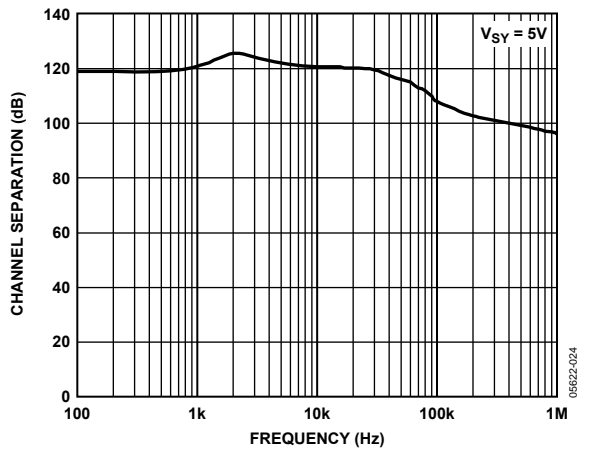

Figure 26. Channel Separation

$V_{SY} = 1.8\text{ V}$ or $\pm 0.9\text{ V}$, unless otherwise noted.

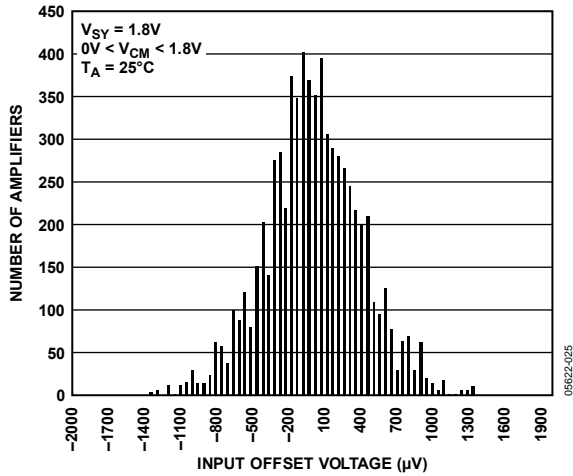

Figure 27. Input Offset Voltage Distribution

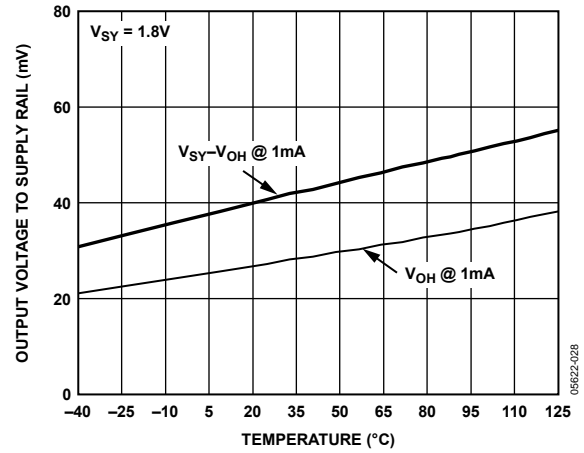

Figure 30. Output Voltage to Supply Rail vs. Temperature ($I_L = 1\text{ mA}$)

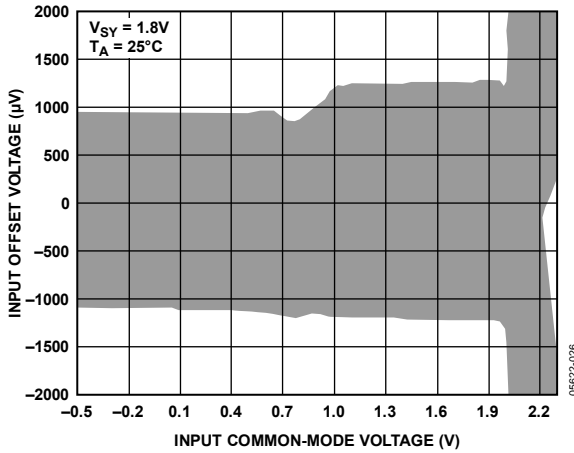

Figure 28. Input Offset Voltage vs. Input Common-Mode Voltage

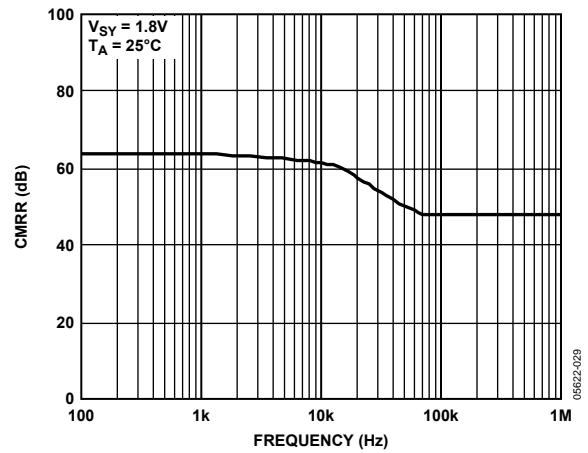

Figure 31. CMRR vs. Frequency

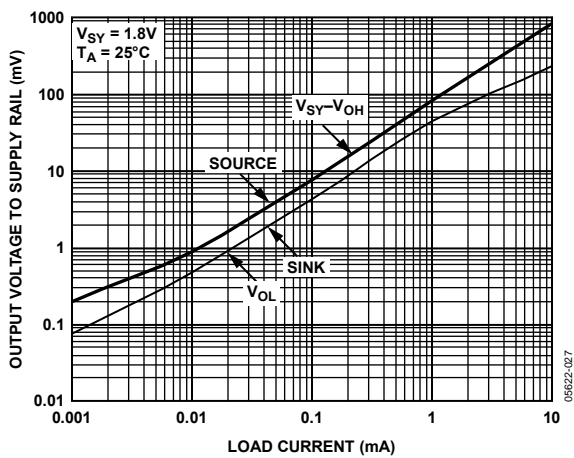

Figure 29. Output Voltage to Supply Rail vs. Load Current

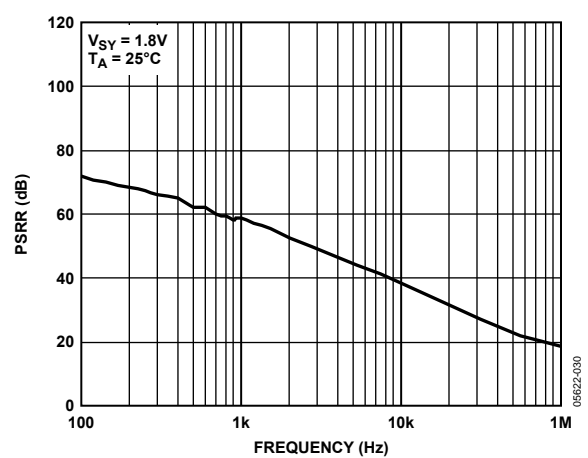

Figure 32. PSRR vs. Frequency

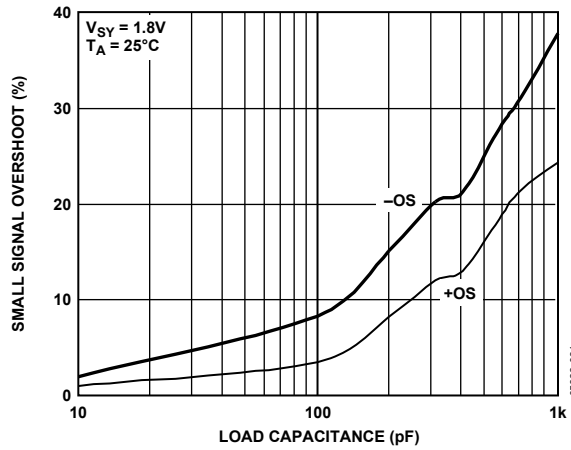

Figure 33. Small Signal Overshoot vs. Load Capacitance

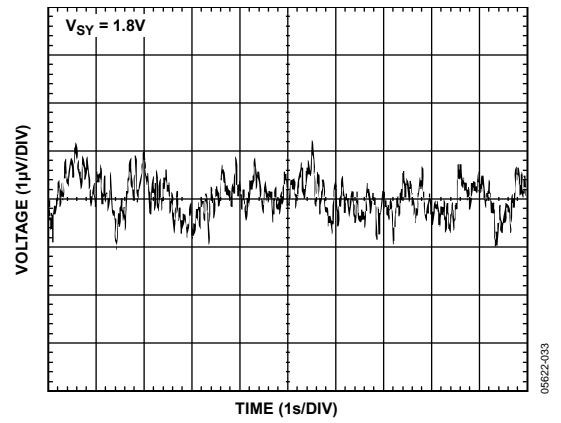

Figure 35. 0.1 Hz to 10 Hz Input Voltage Noise

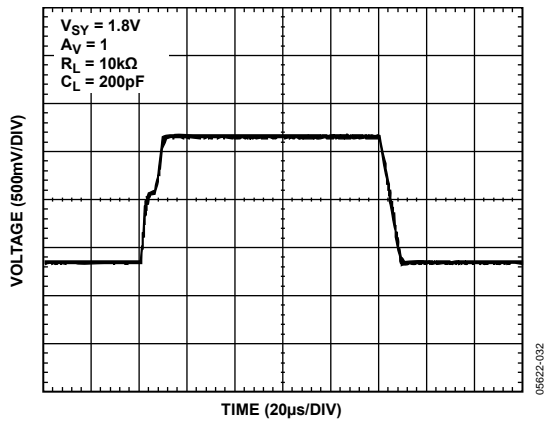

Figure 34. Large Signal Transient Response

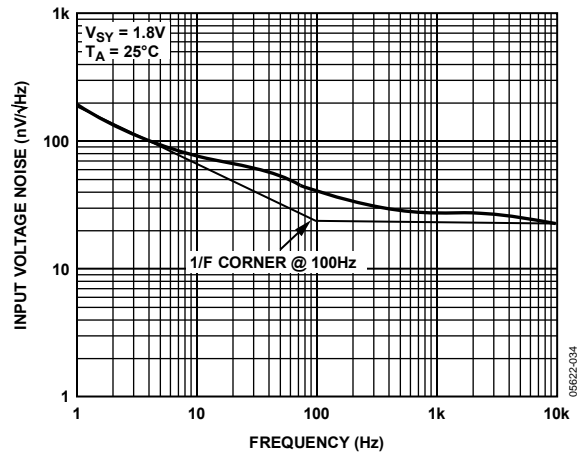
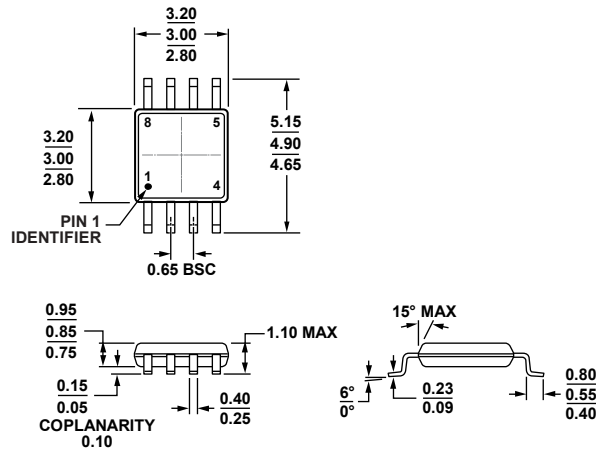

Figure 36. Voltage Noise Density

OUTLINE DIMENSIONS



COMPLIANT TO JEDEC STANDARDS MO-187-AA
 Figure 37. 8-Lead Mini Small Outline Package [MSOP]
 (RM-8)
 Dimensions shown in millimeters

10-07-2009-B

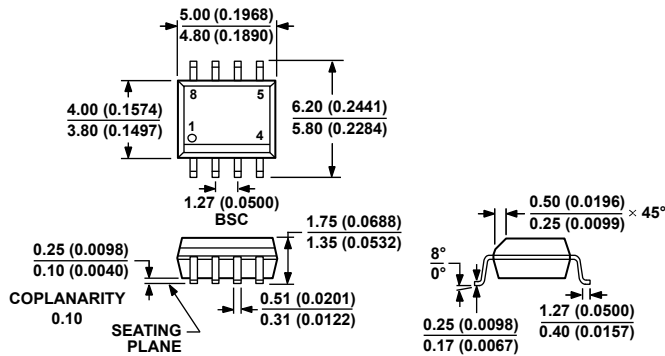

COMPLIANT TO JEDEC STANDARDS MS-012-AA
 CONTROLLING DIMENSIONS ARE IN MILLIMETERS; INCH DIMENSIONS
 (IN PARENTHESES) ARE ROUNDED-OFF MILLIMETER EQUIVALENTS FOR
 REFERENCE ONLY AND ARE NOT APPROPRIATE FOR USE IN DESIGN.
 Figure 38. 8-Lead Standard Small Outline Package [SOIC_N]
 Narrow Body (R-8)
 Dimensions shown in millimeters and (inches)

012407-A

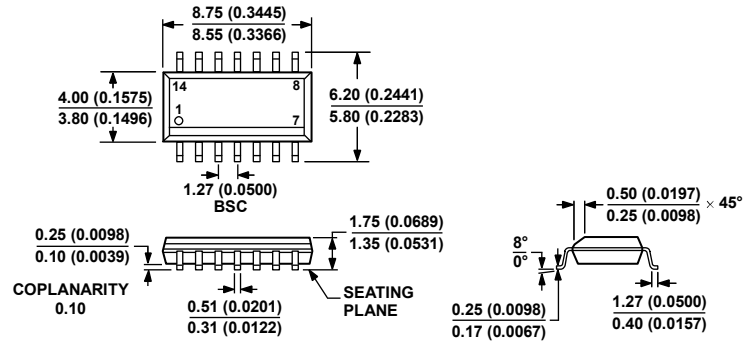

COMPLIANT TO JEDEC STANDARDS MS-012-AB
 CONTROLLING DIMENSIONS ARE IN MILLIMETERS; INCH DIMENSIONS
 (IN PARENTHESES) ARE ROUNDED-OFF MILLIMETER EQUIVALENTS FOR
 REFERENCE ONLY AND ARE NOT APPROPRIATE FOR USE IN DESIGN.

Figure 39. 14-Lead Standard Small Outline Package [SOIC_N]
 Narrow Body (R-14)
 Dimensions shown in millimeters and (inches)

060606-A

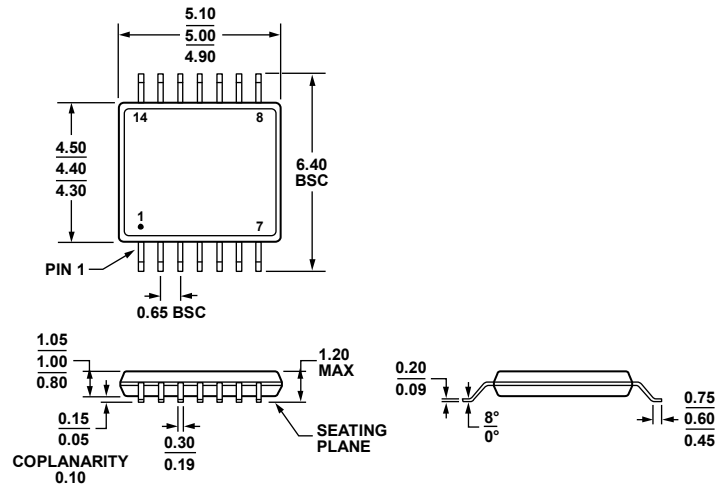

COMPLIANT TO JEDEC STANDARDS MO-153-AB-1

Figure 40. 14-Lead Thin Shrink Small Outline Package [TSSOP]
 (RU-14)
 Dimensions shown in millimeters

06190E-A

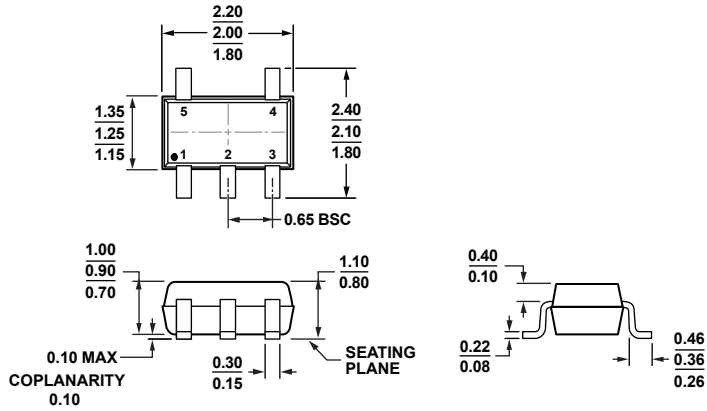

COMPLIANT TO JEDEC STANDARDS MO-203-AA

Figure 41. 5-Lead Thin Shrink Small Outline Transistor Package [SC70] (KS-5)

Dimensions shown in millimeters

072809-A

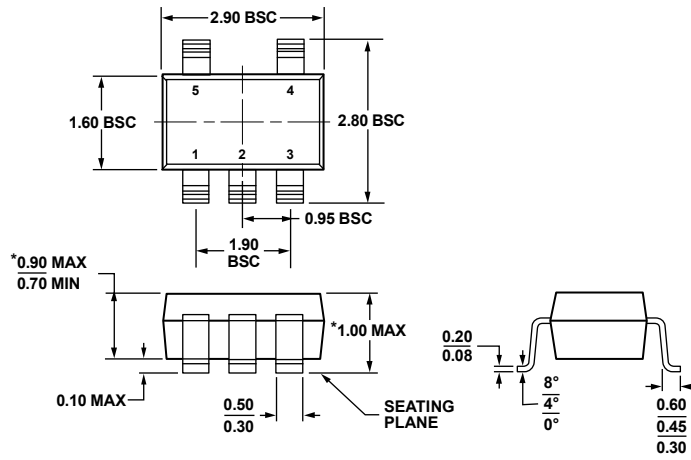

*COMPLIANT TO JEDEC STANDARDS MO-193-AB WITH THE EXCEPTION OF PACKAGE HEIGHT AND THICKNESS.

Figure 42. 5-Lead Thin Small Outline Transistor Package [TSOT-23] (UJ-5)

Dimensions shown in millimeters

100708-A

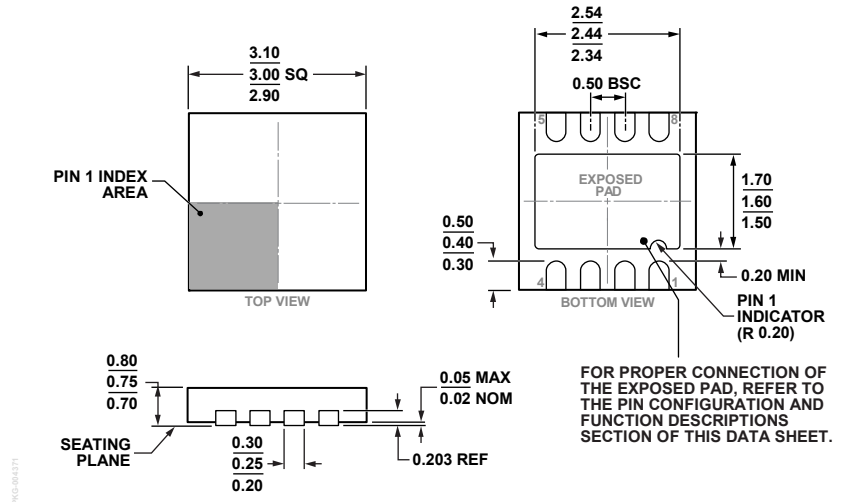

Figure 43. 8-Lead Lead Frame Chip Scale Package [LFCSP]
 3 mm x 3 mm Body and 0.75 mm Package Height
 (CP-8-21)
 Dimensions shown in millimeters

ORDERING GUIDE

Model ^{1,2}	Temperature Range	Package Description	Package Option	Branding
AD8613AKSZ-R2	-40°C to +125°C	5-Lead SC70	KS-5	A0Y
AD8613AKSZ-REEL	-40°C to +125°C	5-Lead SC70	KS-5	A0Y
AD8613AKSZ-REEL7	-40°C to +125°C	5-Lead SC70	KS-5	A0Y
AD8613AUJZ-R2	-40°C to +125°C	5-Lead TSOT-23	UJ-5	A0Y
AD8613AUJZ-REEL	-40°C to +125°C	5-Lead TSOT-23	UJ-5	A0Y
AD8613AUJZ-REEL7	-40°C to +125°C	5-Lead TSOT-23	UJ-5	A0Y
AD8617ACPZ-R2	-40°C to +125°C	8-Lead LFCSP	CP-8-21	A0T
AD8617ACPZ-R7	-40°C to +125°C	8-Lead LFCSP	CP-8-21	A0T
AD8617ARMZ	-40°C to +125°C	8-Lead MSOP	RM-8	A0T
AD8617ARMZ-REEL	-40°C to +125°C	8-Lead MSOP	RM-8	A0T
AD8617ARZ	-40°C to +125°C	8-Lead SOIC_N	R-8	A23
AD8617ARZ-REEL	-40°C to +125°C	8-Lead SOIC_N	R-8	
AD8617ARZ-REEL7	-40°C to +125°C	8-Lead SOIC_N	R-8	
AD8617WARMZ-REEL	-40°C to +125°C	8-Lead MSOP	RM-8	
AD8617WARZ-RL	-40°C to +125°C	8-Lead SOIC_N	R-8	
AD8617WARZ-R7	-40°C to +125°C	8-Lead SOIC_N	R-8	
AD8619ARUZ	-40°C to +125°C	14-Lead TSSOP	RU-14	
AD8619ARUZ-REEL	-40°C to +125°C	14-Lead TSSOP	RU-14	
AD8619ARZ	-40°C to +125°C	14-Lead SOIC_N	R-14	
AD8619ARZ-REEL7	-40°C to +125°C	14-Lead SOIC_N	R-14	
AD8619WARZ-RL	-40°C to +125°C	14-Lead SOIC_N	R-14	
AD8619WARZ-R7	-40°C to +125°C	14-Lead SOIC_N	R-14	
AD8619WARUZ-R7	-40°C to +125°C	14-Lead TSSOP	RU-14	
AD8619WARUZ-RL	-40°C to +125°C	14-Lead TSSOP	RU-14	

¹ Z = RoHS Compliant Part.

² W = Qualified for Automotive Applications.

AUTOMOTIVE PRODUCTS

The [AD8617W](#) and [AD8619W](#) models are available with controlled manufacturing to support the quality and reliability requirements of automotive applications. Note that these automotive models may have specifications that differ from the commercial models; therefore, designers should review the Specifications section of this data sheet carefully. Only the automotive grade products shown are available for use in automotive applications. Contact your local Analog Devices account representative for specific product ordering information and to obtain the specific Automotive Reliability reports for these models.

X-ON Electronics

Largest Supplier of Electrical and Electronic Components

Click to view similar products for [Precision Amplifiers](#) category:

Click to view products by [Analog Devices](#) manufacturer:

Other Similar products are found below :

[561681F](#) [LT6005HGN#PBF](#) [LT6238CGN#PBF](#) [LT6238HGN#PBF](#) [OP05CN8#PBF](#) [OP227GN#PBF](#) [LT6020IDD-1#PBF](#) [LT1124CS8#TR](#)
[NCV20166SN2T1G](#) [NCS20166SN2T1G](#) [NCS21802MUTBG](#) [LT1637MPS8](#) [LT1498IS8](#) [LT1492CS8](#) [TLC27L7CP](#) [TLV2473CDR](#)
[LMP2234AMA/NOPB](#) [LMP7707MA/NOPB](#) [5962-8859301M2A](#) [LMP2231AMAE/NOPB](#) [LMP2234AMTE/NOPB](#) [LMC6022IM/NOPB](#)
[LMC6024IM/NOPB](#) [LMC6081IMX/NOPB](#) [LMP2011MA/NOPB](#) [LMP2231AMFE/NOPB](#) [LMP2232BMA/NOPB](#) [LMP2234AMAE/NOPB](#)
[LMP7717MAE/NOPB](#) [LMV2011MA/NOPB](#) [LT1013DDR](#) [TL034ACDR](#) [TLC2201AMDG4](#) [TLE2024BMDWG4](#) [TS9222IYDT](#)
[TLV2474AQDRG4Q1](#) [TLV2472QDRQ1](#) [TLC4502IDR](#) [TLC27M2ACP](#) [TLC2652Q-8DG4](#) [OPA2107APG4](#) [TL054AIDR](#) [AD8619WARZ-](#)
[R7](#) [TLC272CD](#) [AD8539ARMZ](#) [LTC6084HDD#PBF](#) [LTC1050CN8#PBF](#) [LT1112ACN8#PBF](#) [LT1996AIDD#PBF](#) [LT1112CN8#PBF](#)