

FEATURES

- SNR: 83 dB (85 dBFS) to 10 MHz input**
- SFDR: -87 dBc to 10 MHz input**
- Noise figure: 15 dB**
- Input impedance: 1 k Ω**
- Power: 600 mW**
- 1.8 V analog supply operation**
- 1.8 V to 3.3 V output supply**
- Selectable bandwidth**
 - 2.5 MHz/5 MHz/10 MHz real
 - 5 MHz/10 MHz/20 MHz complex
- Output data rate: 30 MSPS to 160 MSPS**
- Integrated dc and quadrature correction**
- Integrated decimation filters**
- Integrated sample rate converter**
- On-chip PLL clock multiplier**
- On-chip voltage reference**
- Offset binary, Gray code, or twos complement data format**
- Serial control interface (SPI)**

APPLICATIONS

- Baseband quadrature receivers: CDMA2000, W-CDMA, multicarrier GSM/EDGE, 802.16x, and LTE**
- Quadrature sampling instrumentation**
- Medical equipment**
- Radio detection and ranging (RADAR)**

GENERAL DESCRIPTION

The AD9262 is a dual channel, 16-bit analog-to-digital converter (ADC) based on a continuous time (CT) sigma-delta (Σ - Δ) architecture that achieves -87 dBc of dynamic range over a 10 MHz input bandwidth. The integrated features and characteristics unique to the continuous time Σ - Δ architecture significantly simplify its use and minimize the need for external components.

The AD9262 has a resistive input impedance that relaxes the requirements of the driver amplifier. In addition, a 32 \times oversampled fifth-order continuous time loop filter significantly attenuates out-of-band signals and aliases, reducing the need for external filters at the input.

An external clock input or the integrated integer-N PLL provides the 640 MHz internal clock needed for the oversampled continuous time Σ - Δ modulator. On-chip decimation filters and sample rate converters reduce the modulator data rate from 640 MSPS to a user-defined output data rate between 30 MSPS and 160 MSPS, enabling a more efficient and direct interface.

Rev. A

Information furnished by Analog Devices is believed to be accurate and reliable. However, no responsibility is assumed by Analog Devices for its use, nor for any infringements of patents or other rights of third parties that may result from its use. Specifications subject to change without notice. No license is granted by implication or otherwise under any patent or patent rights of Analog Devices. Trademarks and registered trademarks are the property of their respective owners.

FUNCTIONAL BLOCK DIAGRAM

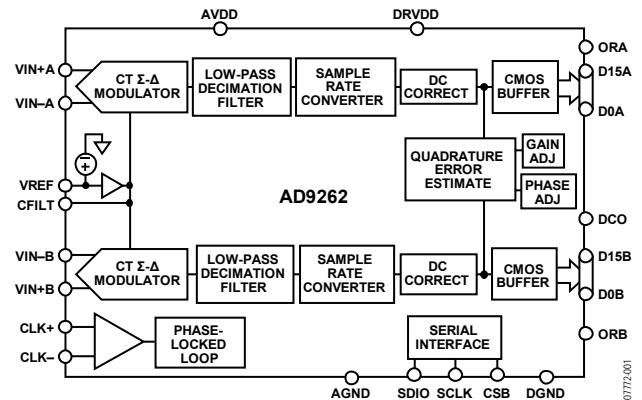

Figure 1

The AD9262 incorporates an integrated dc correction and quadrature estimation block that corrects for gain and phase mismatch between the two channels. This functional block proves invaluable in complex signal processing applications such as direct conversion receivers.

The digital output data is presented in offset binary, Gray code, or twos complement format. A data clock output (DCO) is provided to ensure proper timing with the receiving logic. The AD9262 has the added feature of interleaving Channel A and Channel B data onto one 16-bit bus, simplifying on-board routing.

The ADC is available in three different bandwidth options of 2.5 MHz, 5 MHz, and 10 MHz, and operates on a 1.8 V analog supply and a 1.8 V to 3.3 V digital supply, consuming 600 mW. The AD9262 is available in a 64-lead LFCSP and is specified over the industrial temperature range (-40°C to +85°C).

PRODUCT HIGHLIGHTS

1. Continuous time Σ - Δ architecture efficiently achieves high dynamic range and wide bandwidth.
2. Passive input structure reduces or eliminates the requirements for a driver amplifier.
3. An oversampling ratio of 32 \times and high order loop filter provide excellent alias rejection reducing or eliminating the need for antialiasing filters.
4. An integrated decimation filter, sample rate converter, PLL clock multiplier, and voltage reference provide ease of use.
5. Integrated dc correction and quadrature error correction.
6. Operates from a single 1.8 V analog power supply and 1.8 V to 3.3 V output supply.

TABLE OF CONTENTS

Features	1	AD9262BCPZ-10	12
Applications.....	1	Equivalent Circuits.....	15
General Description	1	Theory of Operation	16
Functional Block Diagram	1	Analog Input Considerations	16
Product Highlights	1	Clock Input Considerations.....	18
Revision History	2	Power Dissipation and Standby Mode	20
Specifications.....	3	Digital Engine	21
DC Specifications	3	DC and Quadrature Error Correction (QEC).....	23
AC Specifications.....	4	Digital Outputs	24
Digital Decimation Filtering Characteristics.....	5	Timing	25
Digital Specifications	6	Serial Port Interface (SPI).....	26
Switching Specifications	7	Configuration Using the SPI.....	26
Absolute Maximum Ratings.....	8	Hardware Interface.....	27
Thermal Resistance	8	Applications Information	28
ESD Caution.....	8	Filtering Requirement.....	28
Pin Configuration and Function Descriptions.....	9	Memory Map	30
Typical Performance Characteristics	10	Memory Map Definitions	30
AD9262BCPZ	10	Outline Dimensions	32
AD9262BCPZ-5.....	11	Ordering Guide	32

REVISION HISTORY

2/10—Rev. 0 to Rev. A

Changes to Figure 61

28

1/10—Revision 0: Initial Version

SPECIFICATIONS

DC SPECIFICATIONS

All power supplies set to 1.8 V, 640 MHz sample rate, 0.5 V internal reference, PLL disabled, 40 MSPS output data rate, $A_{IN}^1 = -2.0$ dBFS, unless otherwise noted.

Table 1.

Parameter	Temp	AD9262BCPZ			AD9262BCPZ-5			AD9262BCPZ-10			Unit
		Min	Typ	Max	Min	Typ	Max	Min	Typ	Max	
RESOLUTION	Full	16			16			16			Bits
ANALOG INPUT BANDWIDTH		2.5			5			10			MHz
ACCURACY		Guaranteed			Guaranteed			Guaranteed			
No Missing Codes	Full	Guaranteed			Guaranteed			Guaranteed			
Offset Error	Full	±0.025	±0.2		±0.025	±0.2		±0.025	±0.2		% FSR
Gain Error	Full	±0.7	±3.0		±0.7	±3.0		±0.7	±3.0		% FSR
Integral Nonlinearity (INL) ²	25°C	±1.5			±1.5			±1.5			LSB
MATCHING CHARACTERISTICS											
Offset Error	Full	±0.035	±0.2		±0.035	±0.2		±0.035	±0.2		% FSR
Gain Error	Full	±0.3	±1.3		±0.3	±1.3		±0.3	±1.3		% FSR
TEMPERATURE DRIFT											
Offset Error	Full	±1.5			±1.5			±1.5			ppm/°C
Gain Error	Full	±50			±50			±50			ppm/°C
INTERNAL VOLTAGE REFERENCE		490	500	510	490	500	510	490	500	510	mV
ANALOG INPUT											
Input Span, $V_{REF} = 0.5$ V	Full	2			2			2			V p-p diff
Common-Mode Voltage	Full	1.7	1.8	1.9	1.7	1.8	1.9	1.7	1.8	1.9	V
Input Resistance	Full	1			1			1			kΩ
POWER SUPPLIES											
Supply Voltage											
AVDD	Full	1.7	1.8	1.9	1.7	1.8	1.9	1.7	1.8	1.9	V
CVDD	Full	1.7	1.8	1.9	1.7	1.8	1.9	1.7	1.8	1.9	V
DVDD	Full	1.7	1.8	1.9	1.7	1.8	1.9	1.7	1.8	1.9	V
DRVDD	Full	1.7	1.8	3.6	1.7	1.8	3.6	1.7	1.8	3.6	V
Supply Current											
I_{AVDD}^2	Full	146		165	146		165	146		165	mA
I_{CVDD}^2 PLL Enabled	Full	57		65	57		65	57		65	mA
I_{CVDD}^2 PLL Disabled	Full	8.1		8.8	8.1		8.8	8.1		8.8	mA
I_{DVDD}^2	Full	108		117	141		152	169		182	mA
I_{DRVDD}^2 (1.8 V)	Full	8.3		8.6	8.7		9.1	10		12.7	mA
I_{DRVDD}^2 (3.3 V)	Full	17			18			22			mA
POWER CONSUMPTION											
Sine Wave Input ² PLL Disabled	Full	487		538.5	547		601.5	600		660	mW
Sine Wave Input ² PLL Enabled	Full	576		640	636		703	688		762	mW
Power-Down Power	Full	23			23			23			mW
Standby Power ²	Full	10			10			10			mW
Sleep Power	Full	3		4	3		4	3		4	mW

¹ Input power is referenced to full scale. Therefore, all measurements were taken with a 2 dB signal below full scale, unless otherwise noted.

² Measured with a low input frequency, full-scale sine wave.

AD9262

AC SPECIFICATIONS

All power supplies set to 1.8 V, 640 MHz sample rate, 0.5 V internal reference, PLL disabled, 40 MSPS output data rate, AIN = -2.0 dBFS, unless otherwise noted.

Table 2.

Parameter ¹	Temp	AD9262BCPZ			AD9262BCPZ-5			AD9262BCPZ-10			Unit
		Min	Typ	Max	Min	Typ	Max	Min	Typ	Max	
SIGNAL-TO-NOISE RATIO (SNR)											
$f_{IN} = 600 \text{ kHz}^2$	Full	86	89								dB
$f_{IN} = 1.2 \text{ MHz}^3$	Full		89		83	86					dB
$f_{IN} = 2.4 \text{ MHz}^4$	Full		89			86		81	83		dB
$f_{IN} = 4.2 \text{ MHz}$	25°C					86			83		dB
$f_{IN} = 8.4 \text{ MHz}$	25°C								83		dB
EFFECTIVE NUMBER OF BITS (ENOB)											
$f_{IN} = 600 \text{ kHz}$	25°C										Bits
$f_{IN} = 1.2 \text{ MHz}$	25°C		14.5								Bits
$f_{IN} = 2.4 \text{ MHz}$	25°C		14.5		14						Bits
$f_{IN} = 4.2 \text{ MHz}$	25°C				14			13.5			Bits
$f_{IN} = 8.4 \text{ MHz}$	25°C							13.5			Bits
SPURIOUS-FREE DYNAMIC RANGE (SFDR)											
$f_{IN} = 600 \text{ kHz}^2$	Full		-87	-80							dBc
$f_{IN} = 1.2 \text{ MHz}^3$	Full		-87		-87	-80					dBc
$f_{IN} = 2.4 \text{ MHz}^4$	Full		<-120		-87			-87	-80		dBc
$f_{IN} = 4.2 \text{ MHz}$	25°C				<-120			-87			dBc
$f_{IN} = 8.4 \text{ MHz}$	25°C							<-120			dBc
NOISE SPECTRAL DENSITY (NSD)											
AIN = -2 dBFS	Full		-154.3	-152	-155	-152		-155	-153		dBFS/Hz
AIN = -40 dBFS	Full		-155.4	-154	-156	-154.5		-156	-154.5		dBFS/Hz
NOISE FIGURE ⁵	25°C		15.6		15			15			dB
TWO-TONE SFDR											
$f_{IN1} = 1.8 \text{ MHz @ -8 dBFS}, f_{IN2} = 2.1 \text{ MHz @ -8 dBFS}$	25°C		-92								dBc
$f_{IN1} = 2.1 \text{ MHz @ -8 dBFS}, f_{IN2} = 2.4 \text{ MHz @ -8 dBFS}$	25°C				-93			-93			dBc
$f_{IN1} = 3.7 \text{ MHz @ -8 dBFS}, f_{IN2} = 4.2 \text{ MHz @ -8 dBFS}$	25°C							-92.5			dBc
$f_{IN1} = 7.2 \text{ MHz @ -8 dBFS}, f_{IN2} = 8.4 \text{ MHz @ -8 dBFS}$	25°C							-92.5			dBc
CROSSTALK ⁶	25°C		-110		-110			-110			dB
ANALOG INPUT BANDWIDTH	25°C			2.5		5			10		MHz
APERTURE JITTER	25°C			1		1			1		ps rms

¹ See the AN-835 Application Note, *Understanding High Speed ADC Testing and Evaluation*, for a complete set of definitions.

² Data guaranteed over the full temperature range for the AD9262BCPZ only.

³ Data guaranteed over the full temperature range for the AD9262BCPZ-5 only.

⁴ Data guaranteed over the full temperature range for the AD9262BCPZ-10 only.

⁵ Noise figure with respect to 50 Ω. AD9262 internal impedance is 1000 Ω differential. See the AN-835 Application Note for a definition.

⁶ Crosstalk measured with an input signal on both channels at different frequencies and the leakage of one on to the other.

DIGITAL DECIMATION FILTERING CHARACTERISTICS

All power supplies set to 1.8 V, 640 MHz sample rate, 0.5 V internal reference, PLL disabled, 40 MSPS output data rate, AIN = -2.0 dBFS, unless otherwise noted.

Table 3.

Parameter ¹	AD9262BCPZ			AD9262BCPZ-5			AD9262BCPZ-10			Unit
	Min	Typ	Max	Min	Typ	Max	Min	Typ	Max	
Pass-Band Transition	2.5		3.75	5		6.5	10		13	MHz
Pass-Band Ripple		<0.1			<0.1			<0.1		dB
Stop Band		3.75 MHz – $f_s/2$			6.5 MHz – $f_s/2$			13 MHz – $f_s/2$		MHz
Stop Band Attenuation		>85			>85			>85		dB

¹ See the AN-835 Application Note, *Understanding High Speed ADC Testing and Evaluation*, for a complete set of definitions.

AD9262

DIGITAL SPECIFICATIONS

All power supplies set to 1.8 V, 640 MHz sample rate, 0.5 V internal reference, PLL disabled, 40 MSPS output data rate, AIN = -2.0 dBFS, unless otherwise noted.

Table 4.

Parameter ¹	Temp	Min	Typ	Max	Unit
DIFFERENTIAL CLOCK INPUTS (CLK+, CLK-)					
Logic Compliance			CMOS/LVPECL		
Differential Input Voltage	Full	0.4	0.8	2	V p-p
Input Common-Mode Range	Full	0.3	0.450	0.5	V
High Level Input Current	Full	-60		+60	μA
Low Level Input Current	Full	-60		+60	μA
Input Resistance	Full		20		kΩ
Input Capacitance	Full		1		pF
LOGIC INPUTS (SCLK)					
High Level Input Voltage	Full	1.2		DRVDD + 0.3	V
Low Level Input Voltage	Full	0		0.8	V
High Level Input Current	Full	-50		-75	μA
Low Level Input Current	Full	-10		+10	μA
Input Resistance	Full		30		kΩ
Input Capacitance	Full		2		pF
LOGIC INPUTS (SDIO, CSB, RESET)					
High Level Input Voltage	Full	1.2		DRVDD + 0.3	V
Low Level Input Voltage	Full	0		0.8	V
High Level Input Current	Full	-10		+10	μA
Low Level Input Current	Full	+40		+135	μA
Input Resistance	Full		26		kΩ
Input Capacitance	Full		5		pF
DIGITAL OUTPUTS					
DRVDD = 3.3 V					
High Level Output Voltage (V _{OH} , I _{OH} = 50 μA)	Full	3.29			V
High Level Output Voltage (V _{OH} , I _{OH} = 0.5 mA)	Full	3.25			V
Low Level Output Voltage (V _{OL} , I _{OL} = 1.6 mA)	Full			0.2	V
Low Level Output Voltage (V _{OL} , I _{OL} = 50 μA)	Full			0.05	V
DRVDD = 1.8 V					
High Level Output Voltage (V _{OH} , I _{OH} = 50 μA)	Full	1.79			V
High Level Output Voltage (V _{OH} , I _{OH} = 0.5 mA)	Full	1.75			V
Low Level Output Voltage (V _{OL} , I _{OL} = 1.6 mA)	Full			0.2	V
Low Level Output Voltage (V _{OL} , I _{OL} = 50 μA)	Full			0.05	V

¹ See the AN-835 Application Note, *Understanding High Speed ADC Testing and Evaluation*, for a complete set of definitions.

SWITCHING SPECIFICATIONS

All power supplies set to 1.8 V, 640 MHz sample rate, 0.5 V internal reference, PLL disabled, 40 MSPS output data rate, AIN = -2.0 dBFS unless otherwise noted.

Table 5.

Parameter ¹	Temp	Min	Typ	Max	Unit
CLOCK INPUT (USING CLOCK MULTIPLIER)					
Conversion Rate	Full	30		160	MSPS
CLK± Period	Full	6.25		33	ns
CLK± Duty Cycle	Full	40	50	60	%
CLOCK INPUT (DIRECT CLOCKING)					
Conversion Rate	Full	608	640	672	MSPS
CLK± Period	Full	1.49	1.5625	1.64	ns
CLK± Duty Cycle	Full	40	50	60	%
DATA OUTPUT PARAMETERS					
Output Data Rate	Full	20		160	MSPS
DCO to Data Skew (t_{SKEW}) ²	Full	3			ns
Sample Latency ³	Full		960		Cycles ⁴
WAKE-UP TIME ⁵					
Power-Down Power	Full		3		μs
Standby Power	Full		9		μs
Sleep Power	Full		15		μs
OUT-OF-RANGE RECOVERY TIME ³					
	Full		960		Cycles ⁴
SERIAL PORT INTERFACE ⁶					
SCLK Period	Full	40			ns
SCLK Pulse Width High Time (t_{SHIGH})	Full	16			ns
SCLK Pulse Width Low Time (t_{SLOW})	Full	16			ns
SDIO to SCLK Setup Time (t_{SDS})	Full	5			ns
SDIO to SCLK Hold Time (t_{SDH})	Full	2			ns
CSB to SCLK Setup Time (t_{SS})	Full	5			ns
CSB to SCLK Hold Time (t_{SH})	Full	2			ns

¹ See the AN-83 5 Application Note, *Understanding High Speed ADC Testing and Evaluation*, for a complete set of definitions.

² Data skew is measured from DCO 50% transition to data (D0x to D15x) 50% transition, with 5 pF load.

³ Typical measured value for the AD9262BCPZ-10. For the AD9262BCPZ-5 and the AD9262BCPZ, typical values double and quadruple the number of cycles, respectively.

⁴ Cycles refers to modulator clock cycles.

⁵ Wake-up time is dependent on the value of the decoupling capacitor, value shown with 10uF capacitor on VREF and CFILT.

⁶ See Figure 60 and the Serial Port Interface (SPI) section.

Timing Diagram

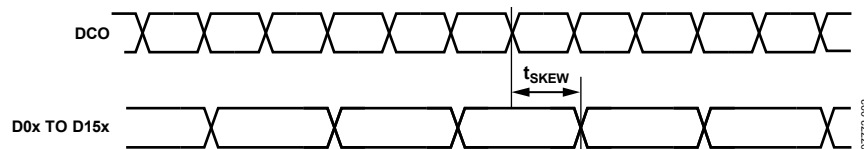

Figure 2. Timing Diagram

ABSOLUTE MAXIMUM RATINGS

Table 6.

Parameter	Rating
Electrical	
AVDD to AGND	−0.3 V to +2.0 V
DVDD to DGND	−0.3 V to +2.0 V
DRVDD to DGND	−0.3 V to +3.9 V
AGND to DGND	−0.3 V to +0.3 V
AVDD to DRVDD	−3.9 V to +2.0 V
CVDD to CGND	−0.3 V to +2.0 V
CGND to DGND	−0.3 V to +0.3 V
D0A to D15A to DGND	−0.3 V to +2.0 V
D0B to D15B to DGND	−0.3 V to +2.0 V
DCO to DGND	−0.3 V to +2.0 V
ORA, ORB to DGND	−0.3 V to +2.0 V
SDIO to DGND	−0.3 V to +3.9 V
CSB to AGND	−0.3 V to +3.9 V
SCLK to AGND	−0.3 V to +3.9 V
VIN+A/VIN−A, VIN+B/VIN−B to AGND	−0.3 V to +2.5 V
CLK+, CLK− to CGND	−0.3 V to +2.0 V
Environmental	
Storage Temperature Range	−65°C to +125°C
Operating Temperature Range	−40°C to +85°C
Lead Temperature (Soldering, 10 Sec)	300°C
Junction Temperature	150°C

Stresses above those listed under Absolute Maximum Ratings may cause permanent damage to the device. This is a stress rating only; functional operation of the device at these or any other conditions above those indicated in the operational section of this specification is not implied. Exposure to absolute maximum rating conditions for extended periods may affect device reliability.

THERMAL RESISTANCE

The exposed paddle must be soldered to the ground plane for the LFCSP package. Soldering the exposed paddle to the PCB increases the reliability of the solder joints, maximizing the thermal capability of the package.

Table 7. Thermal Resistance

Package Type	θ_{JA}	θ_{JC}	Unit
64-Lead LFCSP (CP-64-4)	21.2	1.1	°C/W

Typical θ_{JA} and θ_{JC} are specified for a 4-layer board in still air. Airflow increases heat dissipation, effectively reducing θ_{JA} . In addition, metal in direct contact with the package leads from metal traces, through holes, ground, and power planes reduces the θ_{JA} .

ESD CAUTION



ESD (electrostatic discharge) sensitive device. Charged devices and circuit boards can discharge without detection. Although this product features patented or proprietary protection circuitry, damage may occur on devices subjected to high energy ESD. Therefore, proper ESD precautions should be taken to avoid performance degradation or loss of functionality.

PIN CONFIGURATION AND FUNCTION DESCRIPTIONS

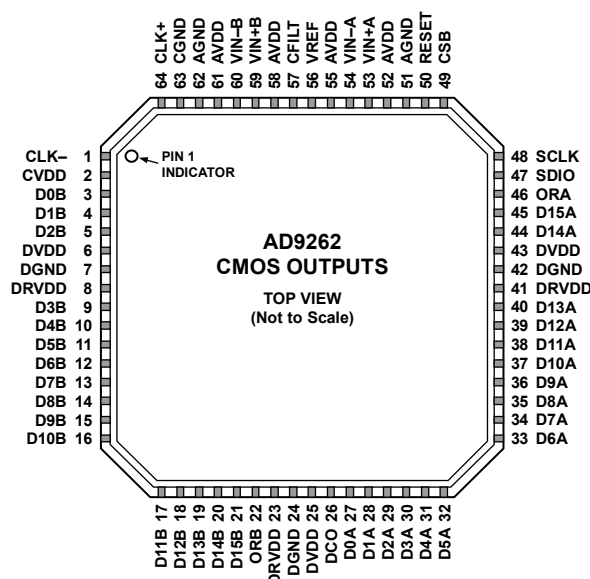

NOTES

1. THE EXPOSED PAD MUST BE SOLDERED TO THE GROUND PLANE FOR THE LFCSP PACKAGE. SOLDERING THE EXPOSED PADDLE TO THE PCB INCREASES THE RELIABILITY OF THE SOLDER JOINTS, MAXIMIZING THE THERMAL CAPACITY OF THE PACKAGE.

07772-003

Figure 3. Pin Configuration

Table 8. Pin Function Descriptions

Pin No.	Mnemonic	Description
1	CLK-	Clock Input (-).
2	CVDD	Clock Supply (1.8 V).
3 to 5, 9 to 21	D0B to D15B	Channel B Data Output Pins. D0B is the LSB and D15B is the MSB.
6, 25, 43	DVDD	Digital Supply (1.8 V).
7, 24, 42	DGND	Digital Ground.
8, 23, 41	DRVDD	Digital Output Driver Supply (1.8 V to 3.3 V).
22	ORB	Channel B Overrange Indicator.
26	DCO	Data Clock Output.
27 to 40, 44, 45	D0A to D15A	Channel A Data Output Pins. D0A is the LSB and D15A is the MSB.
46	ORA	Channel A Overrange Indicator.
47	SDIO	Serial Port Interface Data Input/Output.
48	SCLK	Serial Port Interface Clock.
49	CSB	Serial Port Interface Chip Select Active Low.
50	RESET	Chip Reset.
51, 62	AGND	Analog Ground.
52, 55, 58, 61	AVDD	Analog Supply (1.8 V).
53	VIN+A	Channel A Analog Input (+).
54	VIN-A	Channel A Analog Input (-).
56	VREF	Voltage Reference Input.
57	CFILT	Noise Limiting Filter Capacitor.
59	VIN+B	Channel B Analog Input (+).
60	VIN-B	Channel B Analog Input (-).
63	CGND	Clock Ground.
64	CLK+	Clock Input (+).
65 (EPAD)	Exposed pad (EPAD)	Analog Ground. (Pin 65 is the exposed thermal pad on the bottom of the package.) The exposed pad must be soldered to ground.

TYPICAL PERFORMANCE CHARACTERISTICS

All power supplies set to 1.8 V, 640 MHz sample rate, 2 V p-p differential input, 0.5 V internal reference, PLL disabled, AIN = -2.0 dBFS, $T_A = 25^\circ\text{C}$, output data rate 40 MSPS, unless otherwise noted.

AD9262BCPZ

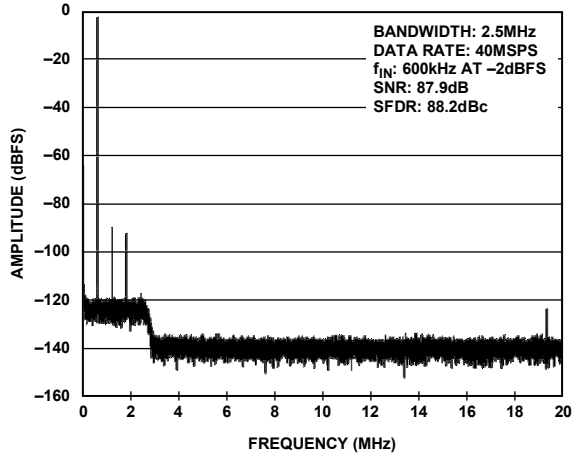

Figure 4. AD9262BCPZ Single-Tone FFT with $f_{IN} = 600 \text{ kHz}$

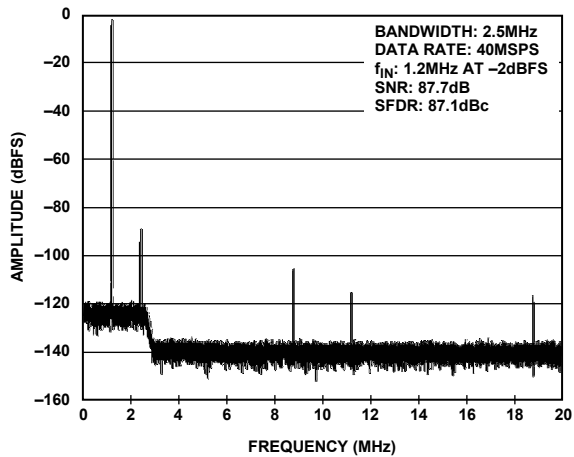

Figure 5. AD9262BCPZ Single-Tone FFT with $f_{IN} = 1.2 \text{ MHz}$

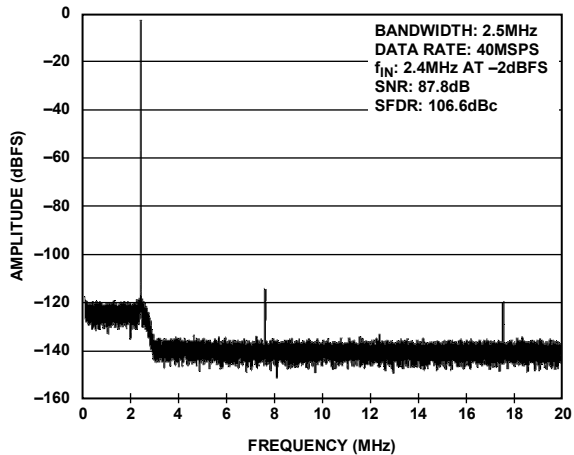

Figure 6. AD9262BCPZ Single-Tone FFT with $f_{IN} = 2.4 \text{ MHz}$

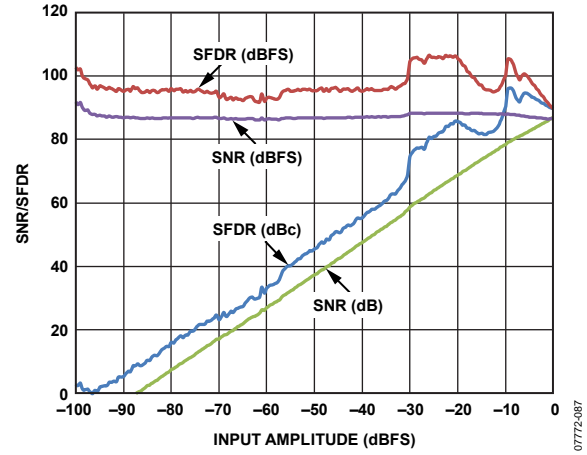

Figure 7. AD9262BCPZ Single-Tone SNR and SFDR vs. Input Amplitude with $f_{IN} = 600 \text{ kHz}$

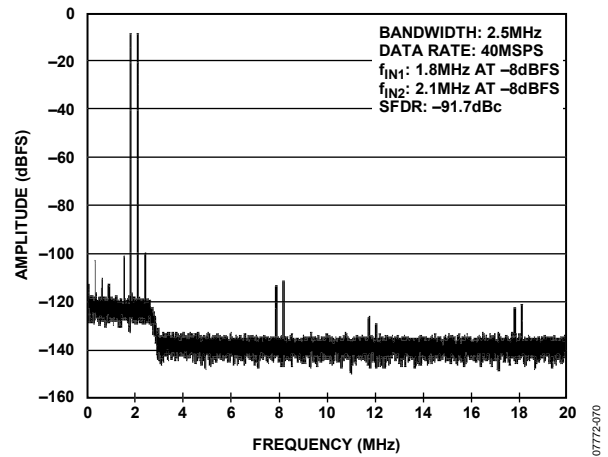

Figure 8. AD9262BCPZ Two-Tone FFT with $f_{IN1} = 1.8 \text{ MHz}$, $f_{IN2} = 2.1 \text{ MHz}$

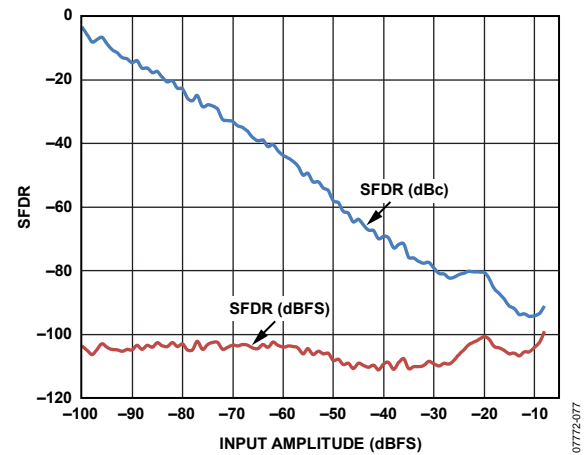

Figure 9. AD9262BCPZ Two-Tone SFDR/IMD3 vs. Input Amplitude with $f_{IN1} = 1.8 \text{ MHz}$, $f_{IN2} = 2.1 \text{ MHz}$

AD9262BCPZ-5

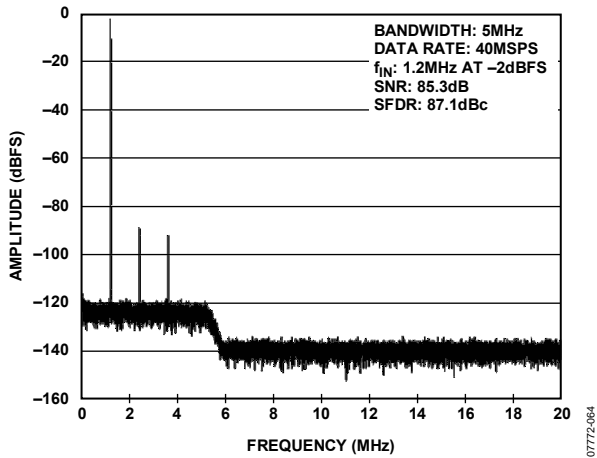

Figure 10. AD9262BCPZ-5 Single-Tone FFT with $f_{IN} = 1.2$ MHz

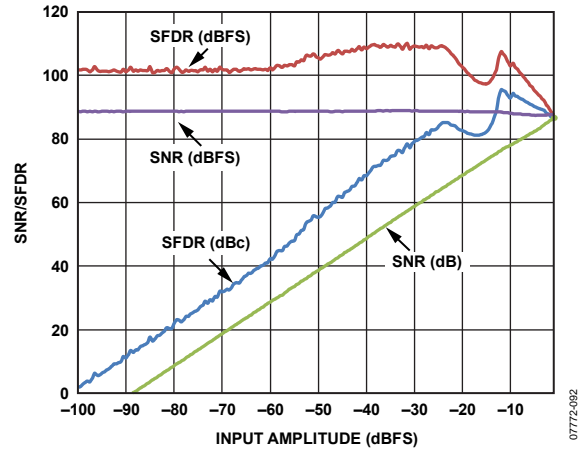

Figure 13. AD9262BCPZ-5 Single-Tone SNR and SFDR vs. Input Amplitude with $f_{IN} = 1.2$ MHz

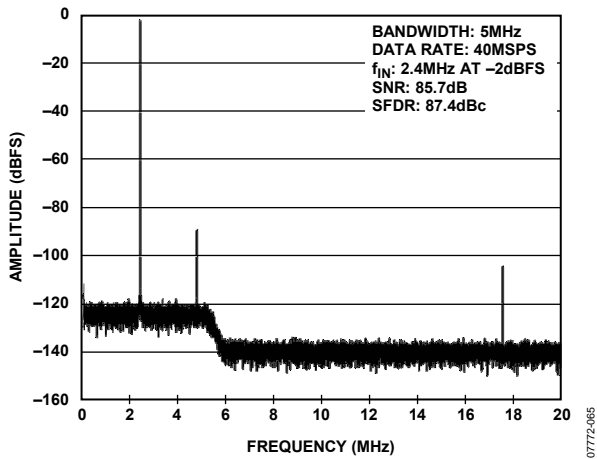

Figure 11. AD9262BCPZ-5 Single-Tone FFT with $f_{IN} = 2.4$ MHz

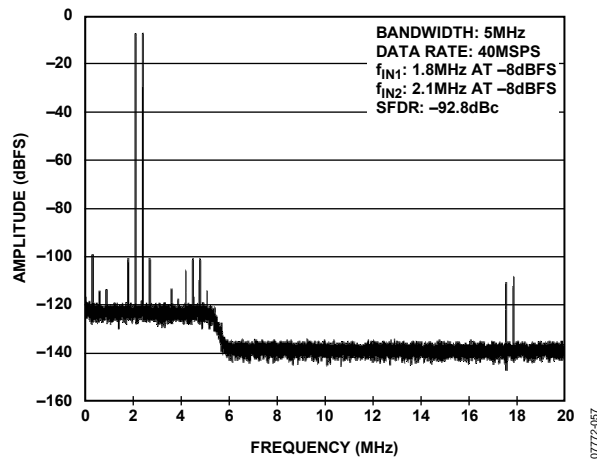

Figure 14. AD9262BCPZ-5 Two-Tone FFT with $f_{IN1} = 1.8$ MHz, $f_{IN2} = 2.1$ MHz

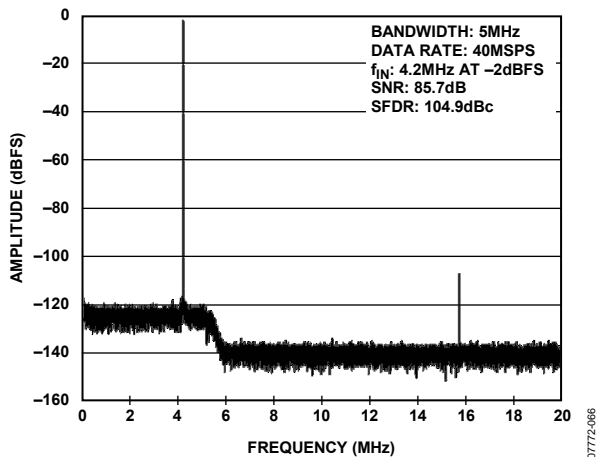

Figure 12. AD9262BCPZ-5 Single-Tone FFT with $f_{IN} = 4.2$ MHz

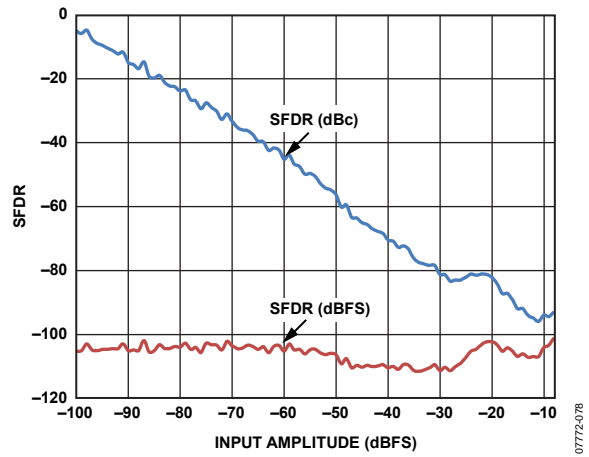

Figure 15. AD9262BCPZ-5 Two-Tone SFDR/IMD3 vs. Input Amplitude with $f_{IN1} = 2.1$ MHz, $f_{IN2} = 2.4$ MHz

AD9262BCPZ-10

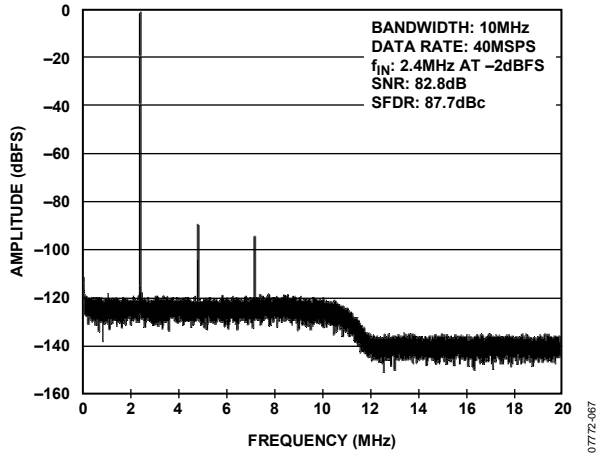

Figure 16. AD9262BCPZ-10 Single-Tone FFT with $f_{IN} = 2.4$ MHz

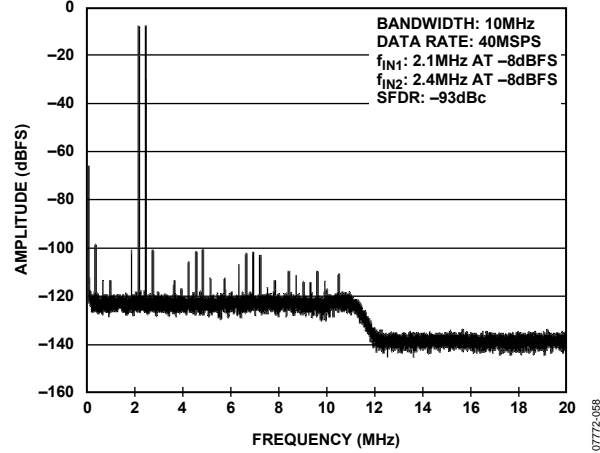

Figure 19. AD9262BCPZ-10 Two-Tone FFT with $f_{IN1} = 2.1$ MHz, $f_{IN2} = 2.4$ MHz

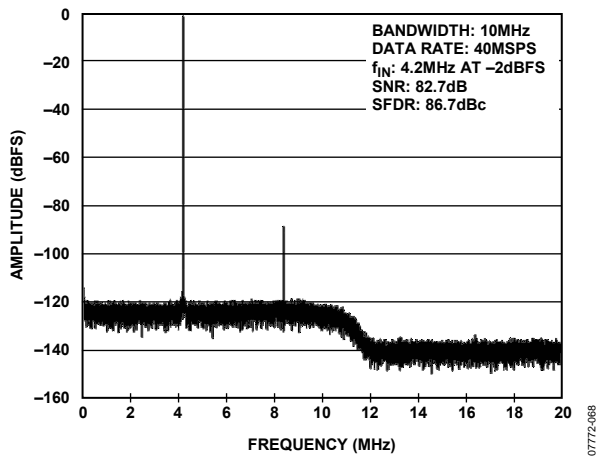

Figure 17. AD9262BCPZ-10 Single-Tone FFT with $f_{IN} = 4.2$ MHz

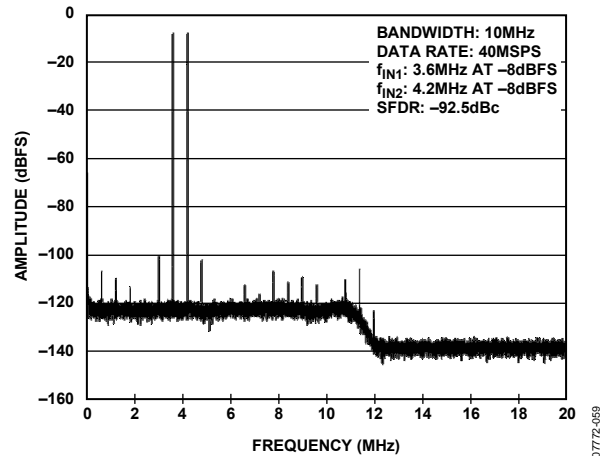

Figure 20. AD9262BCPZ-10 Two-Tone FFT with $f_{IN1} = 3.6$ MHz, $f_{IN2} = 4.2$ MHz

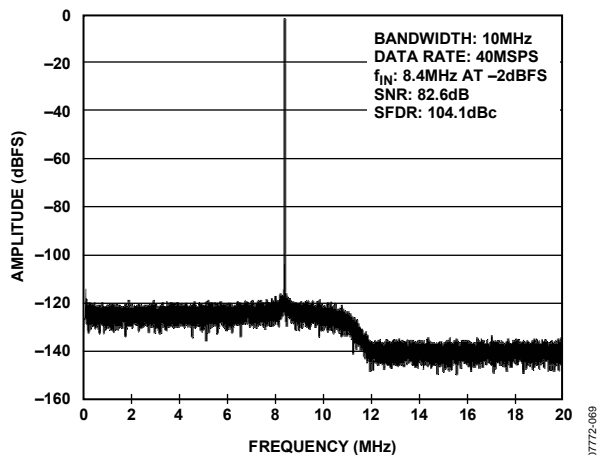

Figure 18. AD9262BCPZ-10 Single-Tone FFT with $f_{IN} = 8.4$ MHz

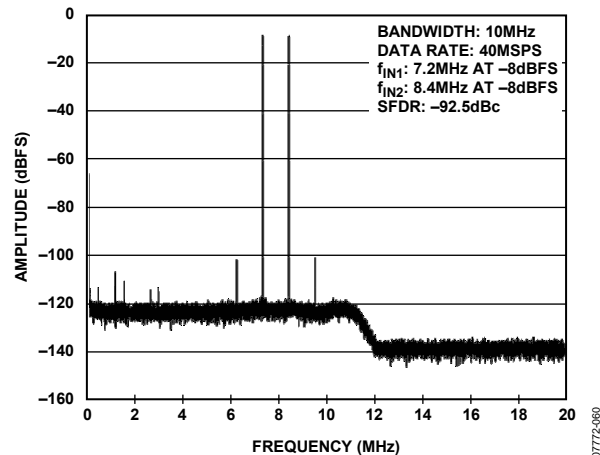

Figure 21. AD9262BCPZ-10 Two-Tone FFT with $f_{IN1} = 7.2$ MHz, $f_{IN2} = 8.4$ MHz

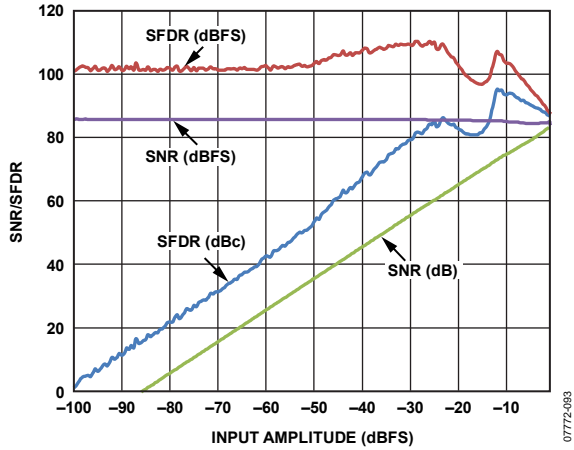

Figure 22. AD9262BCPZ-10 Single-Tone SNR/SFDR vs. Input Amplitude with $f_{IN} = 2.4$ MHz

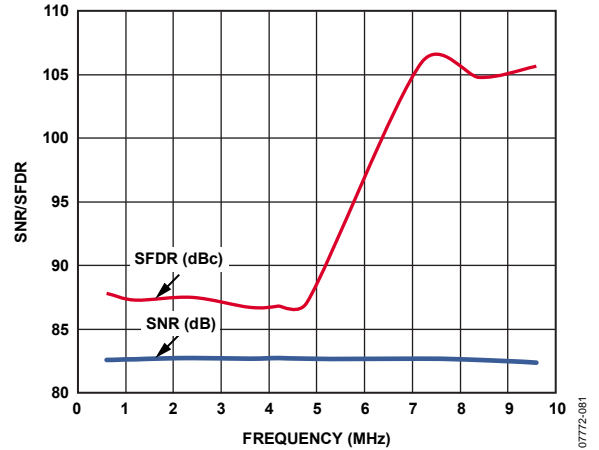

Figure 25. AD9262BCPZ-10 SNR/SFDR vs. Input Frequency

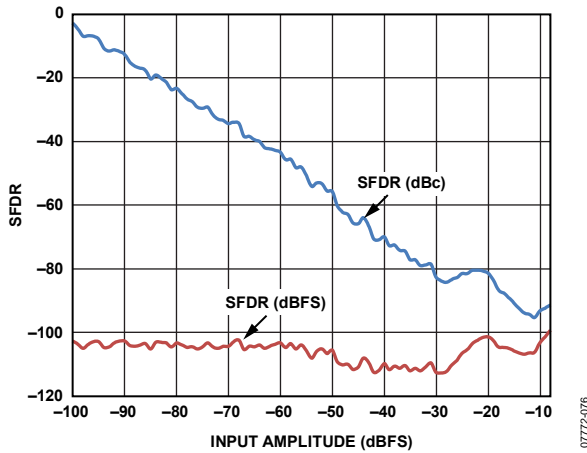

Figure 23. AD9262BCPZ-10 Two-Tone SFDR/IMD3 vs. Input Amplitude with $f_{IN1} = 2.1$ MHz, $f_{IN2} = 2.4$ MHz

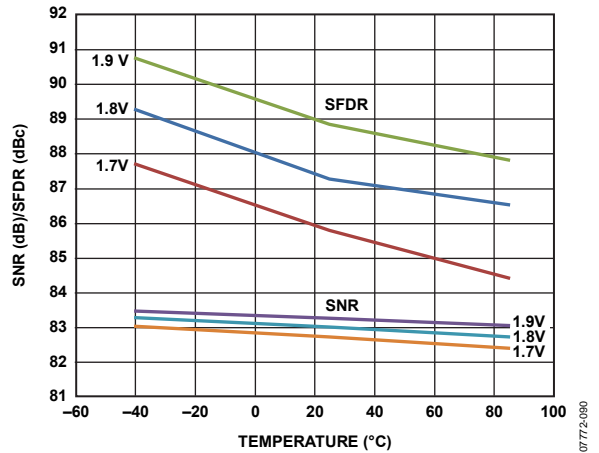

Figure 26. AD9262BCPZ-10 SFDR/SNR vs. Temperature with $f_{IN} = 2.4$ MHz

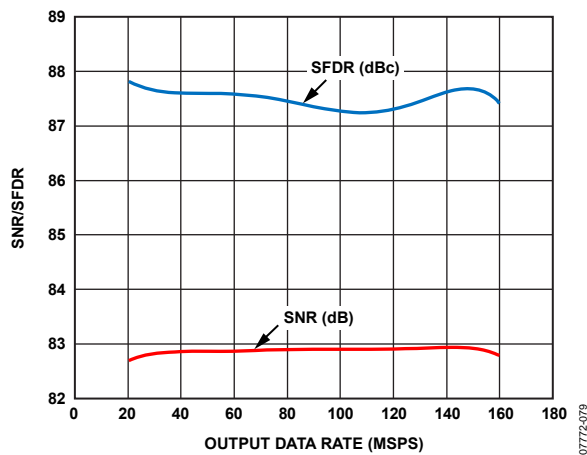

Figure 24. AD9262BCPZ-10 SNR/SFDR vs. Output Data Rate with $f_{IN} = 2.4$ MHz

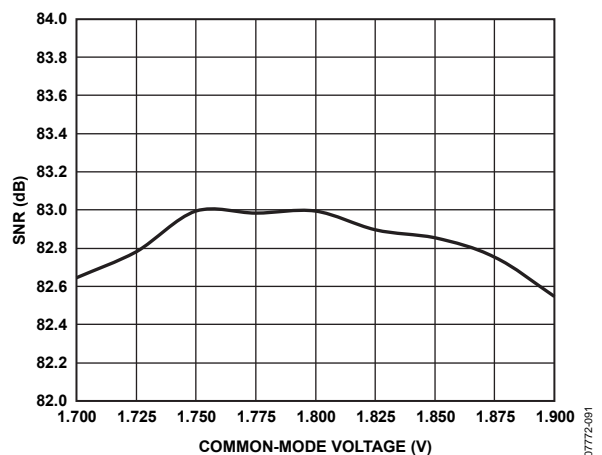

Figure 27. AD9262BCPZ-10 SNR vs. Input Common-Mode Voltage with $f_{IN} = 2.4$ MHz

AD9262

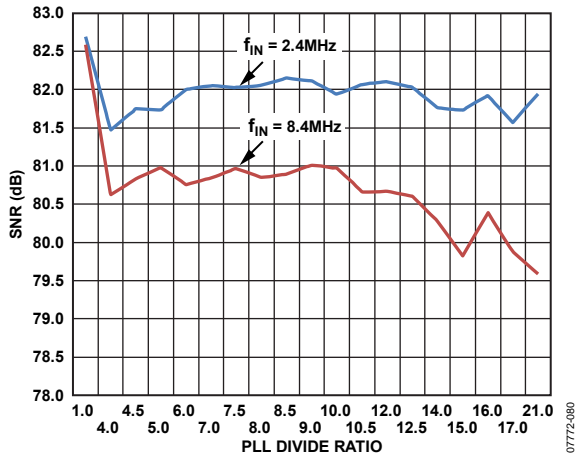

Figure 28. AD9262BCPZ-10 Single-Tone SNR vs. PLL Divide Ratio

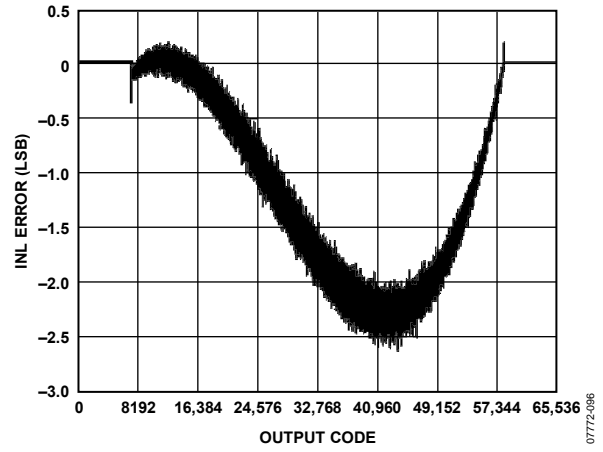

Figure 29. AD9262BCPZ-10 INL

EQUIVALENT CIRCUITS

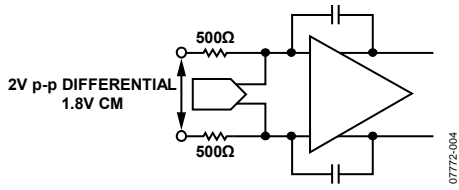

Figure 30. Equivalent Analog Input Circuit

07772-004

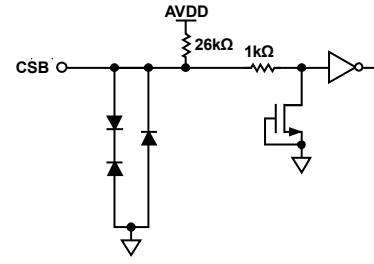

Figure 34. Equivalent CSB Input Circuit

07772-009

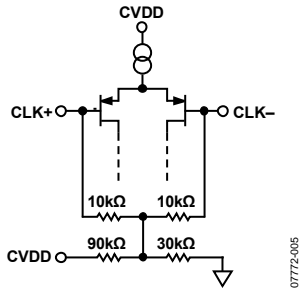

Figure 31. Equivalent Clock Input Circuit

07772-005

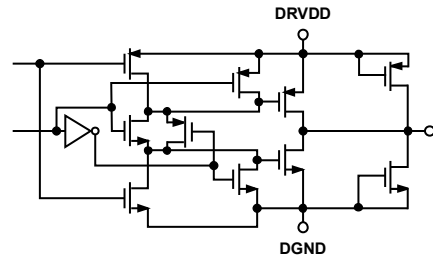

Figure 35. Equivalent Digital Output Circuit

07772-007

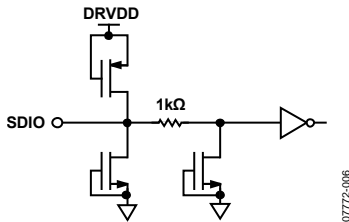

Figure 32. Equivalent SDIO Input Circuit

07772-006

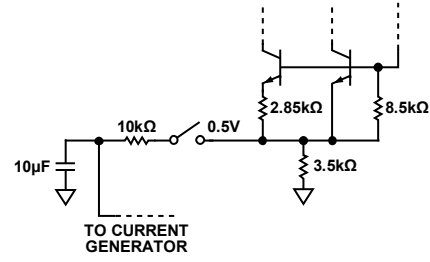

Figure 36. Equivalent VREF Circuit

07772-010

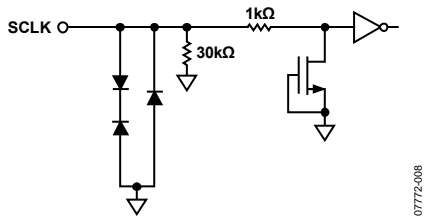

Figure 33. Equivalent SCLK Input Circuit

07772-008

THEORY OF OPERATION

The AD9262 uses a continuous time Σ - Δ modulator to convert the analog input to a digital word. The digital word is processed by the decimation filter and rate-adjusted by the sample rate converter (see Figure 37). The modulator consists of a continuous time loop filter preceding a quantizer that samples at $f_{MOD} = 640$ MSPS. This produces an oversampling ratio (OSR) of 32 for a 10 MHz input bandwidth. The output of the quantizer is fed back to a DAC that ideally cancels the input signal. The incomplete input cancellation residue is filtered by the loop filter and is used to form the next quantizer sample.

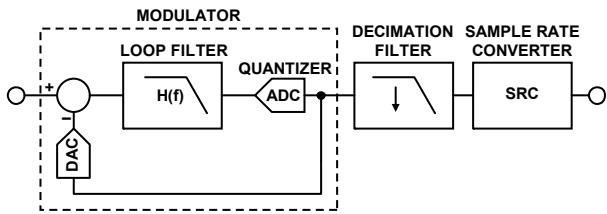

Figure 37. Σ - Δ Modulator Overview

The quantizer produces a nine-level digital word. The quantization noise is spread uniformly over the Nyquist band (see Figure 38), but the feedback loop causes the quantization noise present in the nine-level output to have a nonuniform spectral shape. This noise-shaping technique (see Figure 39) pushes the in-band noise out of band; therefore, the amount of quantization noise in the frequency band of interest is minimal.

The digital decimation filter that follows the modulator removes the large out-of-band quantization noise (see Figure 40), while also reducing the data rate from f_{MOD} to $f_{MOD}/16$. If the internal PLL is enabled, the sample rate converter generates samples at the same frequency as the input clock frequency. If the internal PLL is disabled, the sample rate converter can be programmed to give an output frequency that is a divide ratio of the modulator clock. The sample rate converter is designed to attenuate images outside the band of interest (see Figure 41).

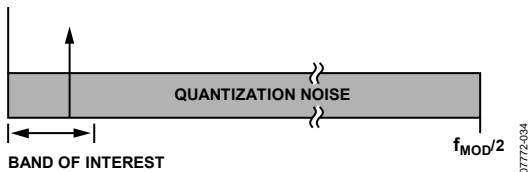

Figure 38. Quantization Noise

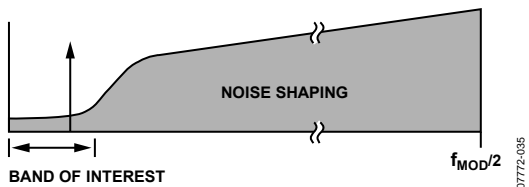

Figure 39. Noise Shaping

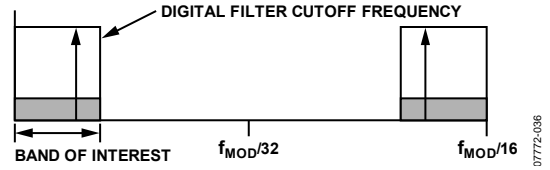

Figure 40. Digital Filter Cutoff Frequency

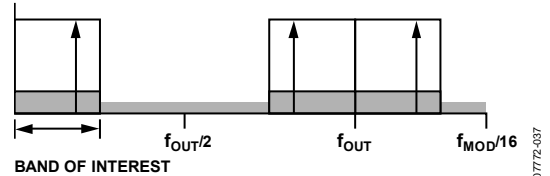

Figure 41. Sample Rate Converter

ANALOG INPUT CONSIDERATIONS

The continuous time modulator removes the need for an anti-alias filter at the input to the AD9262. A discrete time converter aliases signals around the sample clock frequency and its multiples to the band of interest (see Figure 42). Therefore, an external antialias filter is needed to reject these signals.

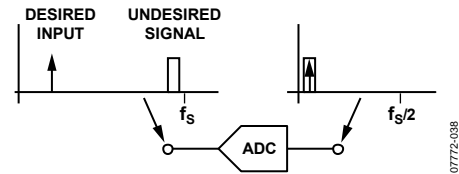

Figure 42. Discrete Time Converter

In contrast, the continuous time Σ - Δ modulator used within the AD9262 has inherent antialiasing. The antialiasing property results from sampling occurring at the output of the loop filter (see Figure 43), and thus aliasing occurs at the same point in the loop as quantization noise is injected; aliases are shaped by the same mechanism as quantization noise. The quantization noise transfer function, $NTF(f)$, has zeros in the band of interest and in all alias bands because $NTF(f)$ is a discrete time transfer function, whereas the loop filter transfer function, $LF(f)$, is a continuous time transfer function, which introduces poles only in the band of interest. The signal transfer function, being the product of $NTF(f)$ and $LF(f)$, only has zeros in alias bands and therefore suppresses all aliases.

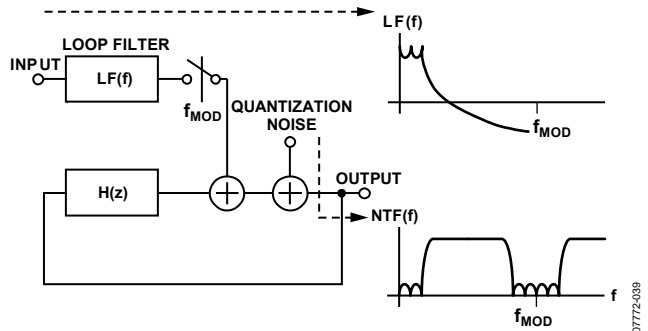

Figure 43. Continuous Time Converter

AD9262

External Reference Operation

If an external reference is desired, the internal reference can be disabled by setting Serial Register 0x18[6] high. Figure 49 shows an application using the ADR130B as a stable external reference.

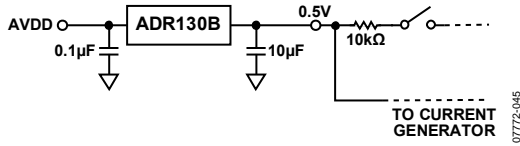

Figure 49. External Reference Configuration

CLOCK INPUT CONSIDERATIONS

The AD9262 offers two modes of sourcing the ADC sample clock (CLK+ and CLK-). The first mode uses an on-chip clock multiplier that accepts a reference clock operating at the lower input frequency. The on-chip phase-locked loop (PLL) then multiplies the reference clock to a higher frequency, which is then used to generate all the internal clocks required by the ADC.

The clock multiplier provides a high quality clock that meets the performance requirements of most applications. Using the on-chip clock multiplier removes the burden of generating and distributing the high speed clock.

The second mode bypasses the clock multiplier circuitry and allows the clock to be directly sourced. This mode enables the user to source a very high quality clock directly to the Σ - Δ modulator. Sourcing the ADC clock directly may be necessary in demanding applications that require the lowest possible ADC output noise. See Figure 28, which shows the degradation in SNR performance for the various PLL settings.

In either case, when using the on-chip clock multiplier or sourcing the high speed clock directly, it is necessary that the clock source have low jitter to maximize the ADC noise performance. High speed, high resolution ADCs are sensitive to the quality of the clock input. As jitter increases, the SNR performance of the AD9262 degrades from that specified in Table 2. The jitter inherent in the part due to the PLL root sum squares with any external clock jitter, thereby degrading performance. To prevent jitter from dominating the performance of the AD9262, the input clock source should be no greater than 1 ps rms of jitter.

The CLK± inputs are self-biased to 450 mV (see Figure 31); if the inputs are dc-coupled, it is important to maintain the specified 450 mV input common-mode voltage. Each input pin can safely swing from 200 mV p-p to 1 V p-p single-ended about the 450 mV common-mode voltage. The recommended clock inputs are CMOS or LVPECL.

The specified clock rate of the Σ - Δ modulator, f_{MOD} , is 640 MHz. The clock rate possesses a direct relationship to the available input bandwidth of the ADC.

$$\text{Bandwidth} = f_{MOD} \div 64$$

In either case, using the on-chip clock multiplier to generate the Σ - Δ modulator clock rate or directly sourcing the clock, any deviation from 640 MHz results in a change in input band-

width. The input range of the clock is limited to 640 MHz \pm 5%. In situations where the AD9262 loses its clock and then later regains it, it is important that the sample rate converter be reset and reprogrammed before the desired output data rate is achieved.

Direct Clocking

The default configuration of the AD9262 is for direct clocking where the PLL is bypassed. Figure 50 shows one preferred method for clocking the AD9262. A low jitter clock source is converted from a single-ended signal to a differential signal using an RF transformer. The back-to-back Schottky diodes across the secondary side of the transformer limits clock excursions into the AD9262 to approximately 0.8 V p-p differential. This helps prevent the large voltage swings of the clock from feeding through to other portions of the AD9262 while preserving the fast rise and fall times of the signal, which are critical to achieving low jitter.

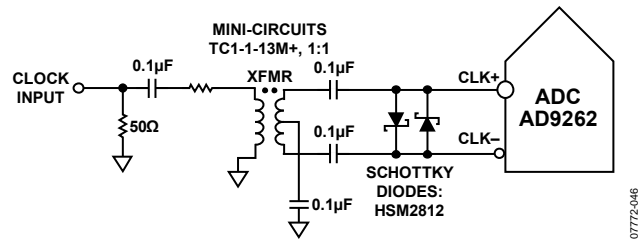

Figure 50. Transformer-Coupled Differential Clock

If a differential clock is not available, the AD9262 can be driven by a single-ended signal into the CLK+ terminal with the CLK- terminal ac-coupled to ground. Figure 51 shows the circuit configuration.

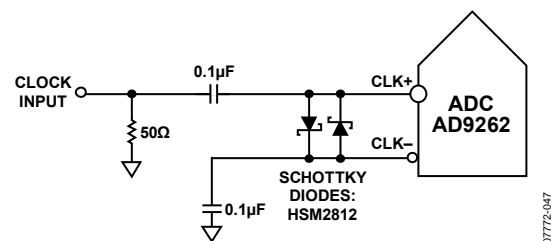
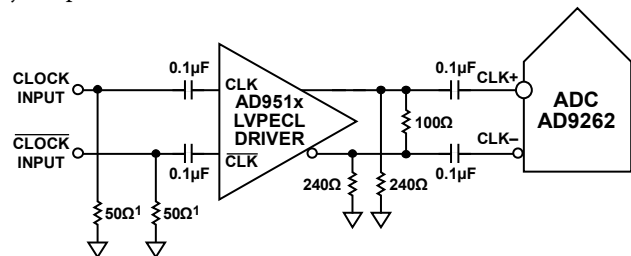

Figure 51. Single-Ended Clock

Another option is to ac couple a differential LVPECL signal to the sample clock input pins, as shown in Figure 52. The AD951x family of clock drivers is recommended because it offers excellent jitter performance.



¹50Ω RESISTORS ARE OPTIONAL.

Figure 52. Differential LVPECL Sample Clock

Internal PLL Clock Distribution

The alternative clocking option available on the AD9262 is to apply a low frequency reference clock and use the on-chip clock multiplier to generate the high frequency f_{MOD} rate. The internal clock architecture is shown in Figure 53.

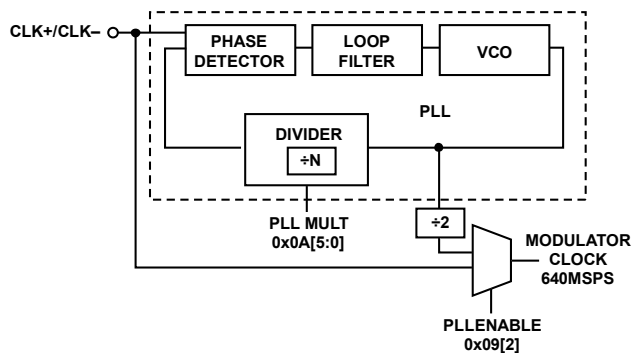

Figure 53. Internal Clock Architecture

The clock multiplication circuit operates such that the VCO outputs a frequency, f_{VCO} , equal to the reference clock input multiplied by N.

$$f_{VCO} = (CLK_{\pm}) \times (N)$$

where N is the PLL multiplication (PLLMULT) factor.

The Σ - Δ modulator clock frequency, f_{MOD} , is equal to

$$f_{MOD} = f_{VCO} \div 2$$

The reference clock, CLK_{\pm} , is limited to 30 MHz to 160 MHz when configured to use the on-chip clock multiplier. Given the input range of the reference clock and the available multiplication factors, the f_{VCO} is approximately 1280 MHz. This results in the desired f_{MOD} rate of 640 MHz with a 50% duty cycle.

Before the PLL enable register bit (PLENABLE) is set, the PLL multiplication factor should be programmed into Register 0x0A[5:0]. After setting the PLENABLE bit, the PLL locks and reports a locked state in Register 0x0A[7]. If the PLL multiplication factor is changed, the PLL enable bit should be reset and set again. Some common clock multiplication factors are shown in Table 11.

The recommended sequence for enabling and programming the on-chip clock multiplier is shown in Table 9.

Table 9. Sequence for Enabling and Programming the PLL

Step	Procedure
1	Apply a reference clock to the CLK_{\pm} pins.
2	Program the PLL multiplication factor in Register 0x0A[5:0]. See Table 10.
3	Enable the PLL; Register 0x09 = 04 (decimal).
4	Enable PLL autoband select.
5	Initiate an SRC reset; Register 0x101[5:0] = 0.
6	Set SRC to desired value via Register 0x101[5:0].

PLL Autoband Select

The PLL VCO has a wide operating range that is covered by overlapping frequency bands. For any desired VCO output frequency, there are multiple valid PLL band select values. The AD9262 possesses an automatic PLL band select feature on chip that determines the optimal PLL band setting. This feature can be enabled by writing to Register 0x0A[6] and is the recommended configuration with the PLL clocking option. When the device is taken out of sleep or standby mode, Register 0x0A[6] must be toggled to reinitiate the autoband detect. See Table 9 for information about enabling the autoband select along with configuring the PLL.

Table 10. PLL Multiplication Factors

0x0A[5:0]	PLLMULT (N)	0x0A[5:0]	PLLMULT (N)
1	8	33	32
2	8	34	34
3	8	35	34
4	8	36	34
5	8	37	34
6	8	38	34
7	8	39	34
8	8	40	34
9	9	41	34
10	10	42	42
11	10	43	42
12	12	44	42
13	12	45	42
14	14	46	42
15	15	47	42
16	16	48	42
17	17	49	42
18	18	50	42
19	18	51	42
20	20	52	42
21	21	53	42
22	21	54	42
23	21	55	42
24	24	56	42
25	25	57	42
26	25	58	42
27	25	59	42
28	28	60	42
29	28	61	42
30	30	62	42
31	30	63	42
32	32	64	42

Table 11. Common Modulator Clock Multiplication Factors

CLK± (MHz)	0x0A[5:0] (PLLMULT)	f _{VCO} (MHz)	f _{MOD} (MHz)	BW (MHz)
30.72	42	1290.24	645.12	10.08
39.3216	32	1258.29	629.15	9.83
52.00	25	1300.00	650.00	10.16
61.44	21	1290.24	645.12	10.08
76.80	17	1305.60	652.80	10.20
78.00	17	1326.00	663.00	10.36
78.6432	16	1258.29	629.15	9.83
89.60	15	1344.00	672.00	10.50
92.16	14	1290.24	645.12	10.08
122.88	10	1228.80	614.40	9.60
134.40	10	1344.00	672.00	10.50
153.60	8	1228.80	614.40	9.60
157.2864	8	1258.29	629.15	9.83

Jitter Considerations

The aperture jitter requirements for continuous time Σ - Δ converters may be more forgiving than Nyquist rate converters. The continuous time Σ - Δ architecture is an oversampled system and to accurately represent the analog input signal to the ADC, a large number of output samples must be averaged together. As a result, the jitter contribution from each sample is root sum squared, resulting in a more subtle impact on noise performance as compared to Nyquist converters where aperture jitter has a direct impact on each sampled output.

In the block diagram of the continuous time Σ - Δ modulator (see Figure 37), the two building blocks most susceptible to jitter are the quantizer and the DAC. The error introduced through the sampling process is reduced by the loop gain and shaped in the same way as the quantization noise and, therefore, its effect can be neglected. On the contrary, the jitter error associated with the DAC directly adds to the input signal, thus increasing the in-band noise power and degrading the modulator performance. The SNR degradation due to jitter can be represented by the following equation.

$$SNR = -20 \log (2\pi f_{analog} t_{jitter_rms}) \text{ dB}$$

where f_{analog} is the analog input frequency and t_{jitter_rms} is the jitter.

The SNR performance of the AD9262 remains constant within the input bandwidth of the converter, from DC to 10 MHz. Therefore, the minimal jitter specification is determined at the highest input frequency. From the calculation, the aperture jitter of the input clock must be no greater than 1 ps to achieve optimal SNR performance.

POWER DISSIPATION AND STANDBY MODE

The AD9262 power consumption can be further reduced by configuring the chip in channel power-down, standby, or sleep mode. The low power modes turn off internal blocks of the chip, including the reference. As a result, the wake-up time is dependent on the amount of circuitry that is turned off. Fewer internal circuits that are powered down result in proportionally shorter wake-up time. The low power modes are shown in Table 12. In the standby mode, all clock related activity and the output channels are disabled. Only the references and CMOS outputs remain powered up to ensure a short recovery and link integrity. During sleep mode, all internal circuits are powered down, putting the device into its lowest power mode, and the CMOS outputs are disabled.

Each ADC channel can be independently powered down or both channels can be set simultaneously by writing to the channel index, Register 0x05[1:0].

Table 12. Low Power Modes

Mode	0x08[1:0]	Analog Circuitry	Clock	Ref
Normal	0x0	On	On	On
Power-Down	0x1	Off	On	On
Standby	0x2	Off	Off	On
Sleep	0x3	Off	Off	Off

DIGITAL ENGINE

Bandwidth Selection

The digital engine (see Figure 54) selects the decimation signal bandwidth by cascading third-order sinc (sinc^3) decimate-by-2 filters. For a 10 MHz signal band, no filters are cascaded; for a 5 MHz signal band, a single filter is used; and for a 2.5 MHz signal band, the 5 MHz filter is cascaded with a second filter. Depending on the signal bandwidth, this drops the data rate into the fixed decimation filter. As a result, lower signal bandwidth options result in lower power. Bandwidth selection is determined by setting Serial Register 0x0F[6:5]. Table 13 summarizes the available bandwidth options.

Table 13. Output Bandwidth Options

BW[1:0]	AD9262BCPZ	AD9262BCPZ-5	AD9262BCPZ-10
0x0	2.5 MHz	5 MHz	10 MHz
0x1	2.5 MHz	5 MHz	5 MHz
0x2	2.5 MHz	2.5 MHz	2.5 MHz
0x3	2.5 MHz	2.5 MHz	2.5 MHz

Decimation Filters

The fixed decimation filters reduce the sample rate from 640 MSPS to 40 MSPS. A fixed frequency low-pass filter is used to define the signal band. This filter incorporates magnitude equalization for the droop of the preceding sinc decimation filters and the sinc filters of the sample rate converter. Table 14 and Table 15 detail the coefficients for the DEC4 and LPF/EQZ filters. Sinc filter implementation for all sinc filters is standard.

Table 14. DEC4 Filter Coefficients

Coefficient Number	Coefficient	Coefficient Number	Coefficient
C0, C22	-21	C6, C16	1121
C1, C21	0	C7, C15	0
C2, C20	122	C8, C14	-2796
C3, C19	0	C9, C13	0
C4, C18	-418	C10, C12	10,184
C5, C17	0	C11	16,384

Table 15. LPF/EQZ Filter Coefficients

Coefficient Number	Coefficient	Coefficient Number	Coefficient
C0, C62	17	C16, C46	694
C1, C61	31	C17, C45	-744
C2, C60	-15	C18, C44	-677
C3, C59	-52	C19, C43	1271
C4, C58	36	C20, C42	450
C5, C57	78	C21, C41	-1909
C6, C56	-84	C22, C40	103
C7, C55	-98	C23, C39	2612
C8, C54	170	C24, C38	-1147
C9, C53	97	C25, C37	-3326
C10, C52	-291	C26, C36	3022
C11, C51	-42	C27, C35	4051
C12, C50	441	C28, C34	-6870
C13, C49	-98	C29, C33	-5305
C14, C48	-592	C30, C32	21,141
C15, C47	353	C31	38,956

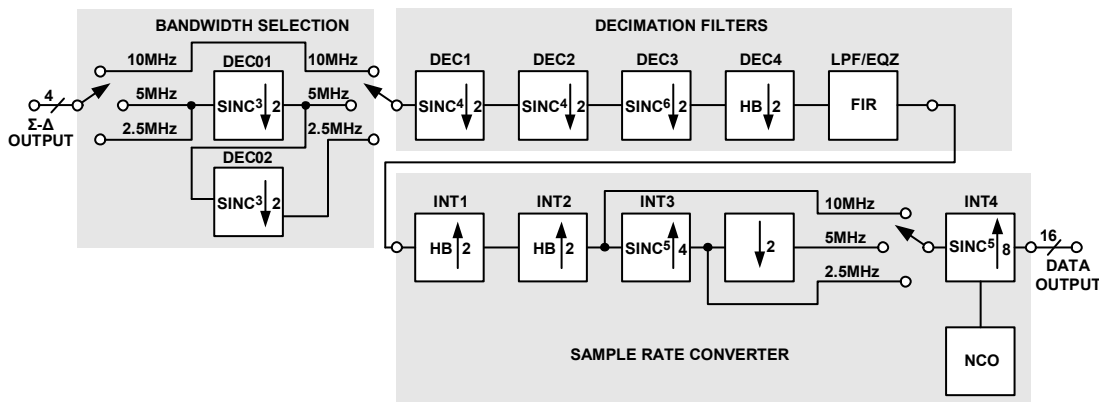

Figure 54. Digital Engine

0772-060

Sample Rate Converter

The sample rate converter (SRC) allows the flexibility of a user-defined output sample rate, enabling a more efficient and direct interface to the digital receiver blocks.

The sample rate converter performs an interpolation and resampling procedure to provide an output data rate of 20 MSPS to 168 MSPS. Table 16 and Table 17 detail the coefficients for the INT1 and INT2 filters. The sinc filters are a standard implementation.

The relationship between the output sample rate and the $\Sigma\text{-}\Delta$ modulator clock rate is expressed as follows:

$$f_{OUT} = f_{MOD} \div K_{OUT}$$

Table 18 shows the available K_{OUT} conversion factors.

Table 16. INT1 Filter Coefficients

Coefficient Number	Coefficient	Coefficient Number	Coefficient
C0, C26	15	C7, C19	0
C1, C25	0	C8, C18	2450
C2, C24	-97	C9, C17	0
C3, C23	0	C10, C16	-5761
C4, C22	361	C11, C15	0
C5, C21	0	C12, C14	20,433
C6, C20	-1017	C13	32,768

Table 17. INT2 Filter Coefficients

Coefficient Number	Coefficient	Coefficient Number	Coefficient
C0, C14	-27	C4, C10	-1032
C1, C13	0	C5, C9	0
C2, C12	227	C6, C8	4928
C3, C11	0	C7	8192

If the main clocking source of the AD9262 is provided by the PLL, it is important, once the PLL has been programmed and locked, to initiate an SRC reset before programming the desired K_{OUT} factor. This is done by first writing $0x101[5:0] = 0$ and then rewriting to the same register with the appropriate K_{OUT} value. In addition, if the AD9262 loses its clock source and then later regains it, an SRC reset should be initiated.

Table 18. SRC Conversion Factors

0x101[5:0]	K_{OUT}	0x101[5:0]	K_{OUT}	0x101[5:0]	K_{OUT}
0	SRC reset	22	11	44	22
1	4	23	11.5	45	22.5
2	4	24	12	46	23
3	4	25	12.5	47	23.5
4	4	26	13	48	24
5	4	27	13.5	49	24.5
6	4	28	14	50	25
7	4	29	14.5	51	25.5
8	4	30	15	52	26
9	4.5	31	15.5	53	26.5
10	5	32	16	54	27
11	5.5	33	16.5	55	27.5
12	6	34	17	56	28
13	6.5	35	17.5	57	28.5
14	7	36	18	58	29
15	7.5	37	18.5	59	29.5
16	8	38	19	60	30
17	8.5	39	19.5	61	30.5
18	9	40	20	62	31
19	9.5	41	20.5	63	31.5
20	10	42	21		
21	10.5	43	21.5		

Cascaded Filter Responses

The cascaded filter responses for the three signal bandwidth settings are for a 160 MSPS output data rate, as shown in Figure 55, Figure 56, and Figure 57.

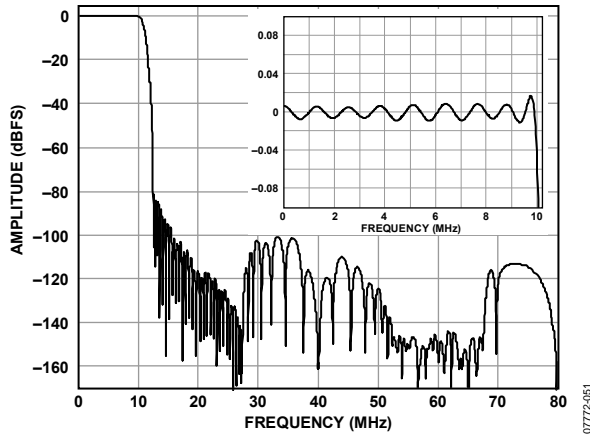

Figure 55. 10 MHz Signal Bandwidth, 160 MSPS

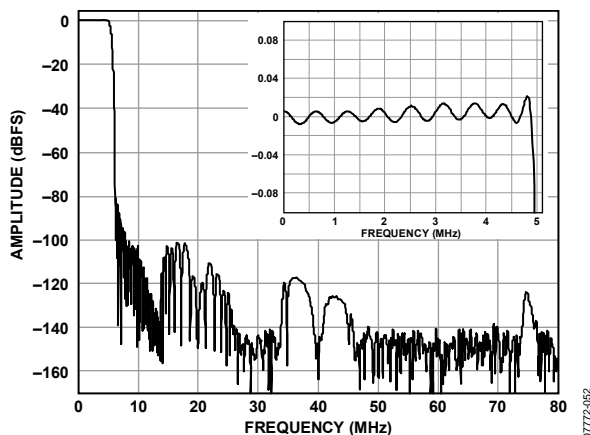

Figure 56. 5 MHz Signal Bandwidth, 160 MSPS

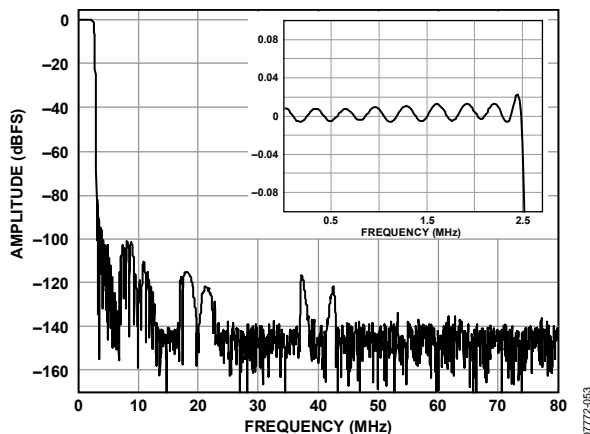

Figure 57. 2.5 MHz Signal Bandwidth, 160 MSPS

DC AND QUADRATURE ERROR CORRECTION (QEC)

In direct conversion or other quadrature systems, mismatches between the real (I) and imaginary (Q) signal paths cause frequencies in the positive spectrum to image into the negative spectrum and vice versa. From an RF point of view, this is equivalent to information above the LO frequency interfering with information below the LO frequency, and vice versa. These mismatches may occur from gain and/or phase mismatches in the analog quadrature demodulator or in any components in the ADC signal chain itself. In a single-carrier zero-IF system where the carrier has been placed symmetrically around dc, this causes self-distortion of the carrier as the two sidebands fold onto one another and degrade the EVM of the signal.

In a multicarrier communication system, this can be even more problematic because carriers of widely different power levels can interfere with one another. For example, a large carrier centered at $+f_1$ can have an image appear at $-f_1$ that can be larger than the desired carrier at this frequency.

The integrated quadrature error correction (QEC) algorithm of the AD9262 attempts to measure and correct the amplitude and phase imbalances of the I and Q signal paths to achieve higher levels of image suppression than is achievable by analog means alone. These errors can be corrected in an adapted manner where the I and Q gain and quadrature phase mismatches are constantly estimated and corrected. This allows changes in the mismatches due to slow supply and temperature changes to be constantly tracked.

The quadrature errors are corrected in a frequency independent manner on the AD9262; therefore, systems with significant mismatch in the baseband chain may have reduced image suppression. The AD9262 QEC still corrects the systematic imbalances.

The convergence time of the QEC algorithm is dependent on the statistics of the input signal. For large signals and large imbalance errors, this convergence time is typically less than two million samples of the AD9262 output data rate.

LO Leakage (DC) Correction

In a direct conversion receiver subsystem, LO to RF leakage of the quadrature modulator shows up as dc offsets at baseband. These offsets are added to dc offsets in the baseband signal paths, and both contribute to a carrier at dc. In a zero-IF receiver, this dc energy can cause problems because it appears in band of a desired channel. As part of the AD9262 QEC function, the dc offset is suppressed by applying a low frequency notch filter to form a null around dc. The 3 dB bandwidth of this notch filter vs. the AD9262 output data rates is shown in Figure 58.

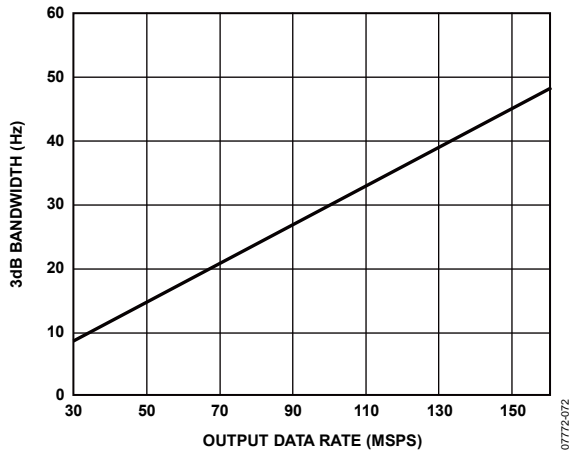

Figure 58. DC Correction Low Frequency Notch Filter 3 dB Bandwidth vs. Output Data Rate

In applications where constant tracking of the dc offsets and quadrature errors are not needed, the algorithms can be independently frozen to save power. When frozen, the image and LO leakage (dc) correction are still performed, but changes are no longer tracked. Register 0x112[5:3] disables the respective correction when frozen.

The quadrature gain, quadrature phase, and dc correction algorithms can also be disabled independently for system debugging or to save power by setting Register 0x112[2:0].

The default configuration on the AD9262 has the QEC and dc correction blocks disabled, and Register 0x101[6] must be pulled high to enable the correction blocks. After the QEC is enabled and a correction value has been calculated, the value remains active as long as any one of the QEC functions (DC, gain, or phase correction) is used.

QEC and DC Correction Range

Table 19 gives the minimum and maximum correction ranges of the algorithms on the AD9262. If the mismatches are greater than these ranges, an imperfect correction results.

Table 19. QEC and DC Correction Range

Parameter	Min	Max
Gain	-1.1 dB	+1.0 dB
Phase	-1.79 degrees	+1.79 degrees
DC	-6 %	+6%

DIGITAL OUTPUTS

Digital Output Format

The AD9262 offers a variety of digital output formats for ease of system integration. The digital output on each channel consists of 16 data bits and an output clock signal (DCO) for data latching. The data bits can be configured for offset binary, twos complement, or Gray code by writing to Register 0x14[1:0]. In addition, the voltage swing of the digital outputs can be configured to 3.3 V TTL levels or a reduced voltage swing of 1.8 V by accessing Register 0x14[7]. When 3.3 V voltage levels are desirable, the DRVDD power supply must be set to 3.3 V.

Interleaved Outputs

The AD9262 has the added feature of interleaving Channel A and Channel B data onto one 16-bit bus. This feature is available for integer values of K_{OUT} greater than 8 and does not apply to half values of K_{OUT} . The interleave function can be accessed by writing to Register 0x14[5]. The data from both Channel A and Channel B are interleaved and presented on the Channel A bus, whereas the Channel B bus is internally grounded. Channel A is sampled on the falling edge of DCO and Channel B on the rising edge. The output of Channel A and Channel B can be interchanged by inverting the DCO clock, Register 0x16[7]. In this case, Channel B is sampled on the falling edge and Channel A on the rising edge.

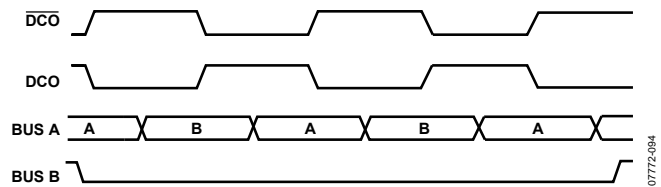

Figure 59. Interleaved Output Mode

Overrange (OR) Condition

The ORA and ORB (ORx) pins serve as indicators for an overrange condition. The ORx pins are triggered by in-band signals that exceed the full-scale range of the ADC. In addition, the AD9262 possesses out-of-band gain above 10 MHz. Therefore, a large out-of-band signal may trip an overrange condition.

The ORx pins are synchronous outputs that are updated at the output data rate. Ideally, ORx should be latched on the falling edge of DCO to ensure proper setup-and-hold time. However, because an overrange condition typically extends well beyond one clock cycle (that is, it does not toggle at the DCO rate) data can usually be successfully detected on the rising edge of DCO or monitored asynchronously.

The AD9262 has two trip points that can trigger an overrange condition: analog and digital. The analog trip point is located in the modulator, and the second trip point is in the digital engine. In normal operation, it is possible for the analog trip point to toggle the ORx pin for a number of clock cycles as the analog input approaches full scale. Because the ORx pin is a pulse-width modulated (PWM) signal, as the analog input increases in amplitude, the duration of overrange pin toggling increases. Eventually, when the ORx pin is high for an extended period of time, the ADC is overloaded, whereby there is little correspondence between analog input and digital output.

The second trip point is in the digital block. If the input signal is large enough to cause the data bits to clip to its maximum full-scale level, an overrange condition occurs. The overrange trip point can be adjusted by specifying a threshold level.

Table 20 shows the corresponding threshold level in dBFS vs. register setting. If the input signal crosses this level, the ORx pin is set. In the case where 0x111[5:0] is set to all 0s, the threshold level is set to the maximum code of 32,767₁₀. This feature provides a means of reporting the instantaneous amplitude as it crosses a user-provided threshold. This gives the user a sense of the signal level without needing to perform a full power measurement.

The user has the ability to select how the overrange conditions are reported, and this is controlled through Register 0x111 via AUTORST, OR_IND, and ORTHRESH (see Table 21). By enabling the AUTORST bit, Register 0x111[7], if an overrange occurs, the ADC automatically resets itself. The ORx pins remain high until the automatic reset has completed. If an analog trip

occurs, the modulator resets itself after 16 consecutive clock cycles of overrange.

If the AD9262 is used in a system that incorporates automatic gain control (AGC), the ORx signal can be used to indicate that the signal amplitude should be reduced. This may be particularly effective for use in maximizing the signal dynamic range if the signal includes high occurrence components that occasionally exceed full scale by a small amount.

TIMING

The AD9262 provides a data clock out (DCO) pin to assist in capturing the data in an external register. The data outputs are valid on the rising edge of DCO, unless changed by setting Serial Register 0x16[7] (see the Serial Port Interface (SPI) section). See Figure 2 for a graphical timing description.

Table 20. OR Threshold Levels

0x111[5:0]	Threshold (dBFS)	0x111[5:0]	Threshold (dBFS)	0x111[5:0]	Threshold (dBFS)
1	-36.12	16	-9.28	2B	-3.45
2	-30.10	17	-8.89	2C	-3.25
3	-26.58	18	-8.52	2D	-3.06
4	-24.08	19	-8.16	2E	-2.87
5	-22.14	1A	-7.82	2F	-2.68
6	-20.56	1B	-7.50	30	-2.50
7	-19.22	1C	-7.18	31	-2.32
8	-18.06	1D	-6.88	32	-2.14
9	-17.04	1E	-6.58	33	-1.97
A	-16.12	1F	-6.30	34	-1.80
B	-15.29	20	-6.02	35	-1.64
C	-14.54	21	-5.75	36	-1.48
D	-13.84	22	-5.49	37	-1.32
E	-13.20	23	-5.24	38	-1.16
F	-12.60	24	-5.00	39	-1.00
10	-12.04	25	-4.76	3A	-0.86
11	-11.51	26	-4.53	3B	-0.71
12	-11.02	27	-4.30	3C	-0.56
13	-10.56	28	-4.08	3D	-0.42
14	-10.10	29	-3.87	3E	-0.28
15	-9.68	2A	-3.66	3F	-0.14

Table 21. ORx Conditions

ORx Conditions	AUTORST	OR_IND	ORTHRESH[5:0]	ORTHRESH[4:0]	Description
Normal, Reset Off	0	0	0	00000	Digital trip: if 16-bit output > 32,767, ORx = 1, else ORx = 0
Digital Threshold, Reset Off	0	0	>0		Digital threshold: if 16-bit output > ORTHRESH, ORx = 1, else ORx = 0
Full Overrange, Reset Off	0	1	0	X	If analog trip or digital trip, ORx = 1, else ORx = 0
Data Valid, No Reset	0	1	1	X	If analog trip or digital trip or calibration, ORx = 0, else ORx = 1
Normal, Reset On	1	0	0	00000	Digital trip: if 16-bit output > 32,767, ORx = 1, else ORx = 0
Digital Threshold, Reset On	1	0	>0		Digital threshold: if 16-bit output > ORTHRESH, ORx = 1, else ORx = 0
Full Overrange, Reset On	1	1	0	X	If analog trip or digital trip ORx = 1 else ORx = 0
Data Valid, Reset On	1	1	1	X	If analog trip or digital trip or calibration, ORx = 0 else ORx = 1

SERIAL PORT INTERFACE (SPI)

The AD9262 serial port interface (SPI) allows the user to configure the converter for specific functions or operations through a structured register space provided inside the ADC. This provides the user added flexibility and customization depending on the application. Addresses are accessed via the serial port and can be written to or read from via the port. Memory is organized into bytes that are further divided into fields, as documented in the Memory Map section. For detailed operational information, see the AN-877 Application Note, *Interfacing to High Speed ADCs via SPI*.

CONFIGURATION USING THE SPI

As summarized in Table 22, three pins define the SPI of this ADC. The SCLK pin synchronizes the read and write data presented to the ADC. The SDIO pin allows data to be sent and read from the internal ADC memory map registers. The CSB pin is an active low control that enables or disables the read and write cycles.

Table 22. Serial Port Interface Pins

Pin Name	Description
SCLK	SCLK (serial clock) is the serial shift clock. SCLK synchronizes serial interface reads and writes.
SDIO	SDIO (serial data input/output) is an input and output depending on the instruction being sent and the relative position in the timing frame.
CSB	CSB (chip select bar) is an active low control that gates the read and write cycles.

The falling edge of CSB in conjunction with the rising edge of SCLK determines the start of the framing. Figure 60 and Table 23 provide an example of the serial timing and its definitions.

Other modes involving CSB are available. CSB can be held low indefinitely to permanently enable the device (this is called streaming). CSB can stall high between bytes to allow for additional external timing. When CSB is tied high, SPI functions are placed in a high impedance mode.

During an instruction phase, a 16-bit instruction is transmitted. Data follows the instruction phase, and the length is determined by the W0 bit and the W1 bit. All data is composed of 8-bit words. The first bit of each individual byte of serial data indicates whether a read or write command is issued. This allows the serial data input/output (SDIO) pin to change direction from an input to an output.

In addition to word length, the instruction phase determines if the serial frame is a read or write operation, allowing the serial port to be used to both program the chip and to read the contents of the on-chip memory. If the instruction is a readback operation, performing a readback causes the serial data input/output (SDIO) pin to change direction from an input to an output at the appropriate point in the serial frame.

Data can be sent in MSB-first or in LSB-first mode. MSB first is the default setting on power-up and can be changed via the configuration register. For more information, see the AN-877 Application Note, *Interfacing to High Speed ADCs via SPI*.

Table 23. SPI Timing Diagram Specifications

Parameter	Description
t_{SDS}	Setup time between data and rising edge of SCLK
t_{SDH}	Hold time between data and rising edge of SCLK
t_{SCLK}	Period of the clock
t_{SS}	Setup time between CSB and SCLK
t_{SH}	Hold time between CSB and SCLK
t_{SHIGH}	Minimum period that SCLK should be in a logic high state
t_{SLOW}	Minimum period that SCLK should be in a logic low state

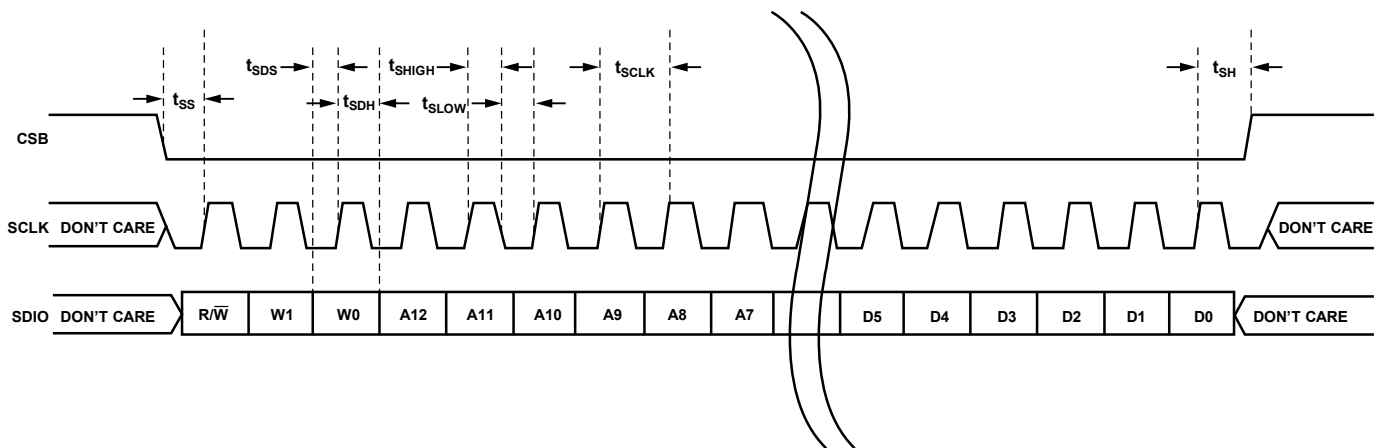

Figure 60. Serial Port Interface Timing Diagram

0772-054

HARDWARE INTERFACE

The pins described in Table 22 comprise the physical interface between the programming device of the user and the serial port of the AD9262. The SCLK and CSB pins function as inputs when using the SPI interface. The SDIO pin is bidirectional, functioning as an input during write phases and as an output during readback.

The SPI interface is flexible enough to be controlled by either PROM or PIC microcontrollers. This provides the user with the ability to use an alternate method to program the ADC. One such method is described in detail in the AN-812 Application Note, *MicroController-Based Serial Port Interface (SPI) Boot Circuit*.

APPLICATIONS INFORMATION

FILTERING REQUIREMENT

The need for antialias protection often requires one or two octaves for a transition band, which reduces the usable bandwidth of a Nyquist converter to between 25% and 50% of the available bandwidth. A CT Σ - Δ converter maximizes the available signal bandwidth by forgoing the need for an anti-aliasing filter because the architecture possesses inherent anti-aliasing. Although a high order, sharp cutoff antialiasing filter may not be necessary because of the unique characteristics of the architecture, a low order filter may still be required to precede the ADC for out-of-band signal handling.

Depending on the application and the system architecture, this low order filter may or may not be necessary. The signal transfer function (STF) of a continuous time feedforward ADC usually contains out-of-band peaks. Because these STF peaks are typically one or two octaves above the pass-band edge, they are not problematic in applications where the bulk of the signal energy is in or near the pass band. However, in applications with large far-out interferers, it is necessary to either add a filter to attenuate these problematic signals or to allocate some of the ADC dynamic range to accommodate them.

Figure 61 shows the normalized STF of the AD9262 CT Σ - Δ converter. The figure shows out-of-band peaking beyond the band edge of the ADC. Within the 10 MHz band of interest, the STF is maximally flat with less than 0.1 dB of gain. Maximum peaking occurs at 60 MHz with 10 dB of gain. To put this into perspective, for a fixed input power, a 5 MHz in-band signal appears at -5 dBFS, a 25 MHz tone appears at -2 dBFS and 60 MHz tone at $+5$ dBFS. Because the maximum input to the ADC is -2 dBFS, large out-of-band signals can quickly saturate the system. This implies that, under these conditions, the digital outputs of the ADC no longer accurately represent the input. See the Overrange (OR) Condition section for details on over-range detection and recovery.

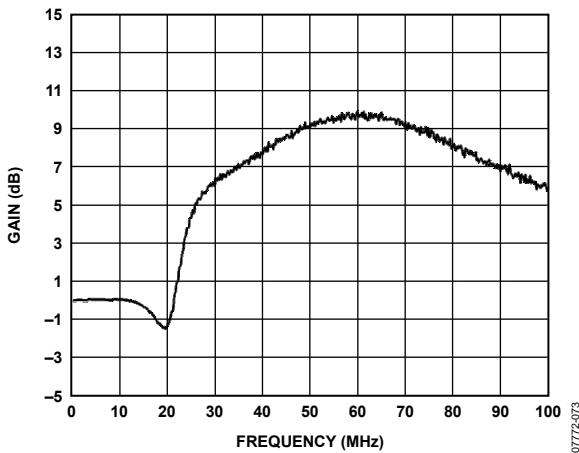

Figure 61. STF

Figure 61 shows the gain profile of the AD9262, and this can be interpreted as the level at which the signal power should be scaled back to prevent an overload condition. This is the ultimate trip point and before this point is reached, the in-band noise (IBN) slowly degrades. As a result, it is recommended that the low-pass filter be designed to match the profile of Figure 62, which shows the maximum input signal for a 3 dB degradation of in-band noise. The input signal is attenuated to allow only 3 dB of noise degradation over frequency.

The noise performance is normalized to a -2 dBFS in-band signal. The AD9262 STF and NTF are flat within the band of interest and should result in almost no change in input level and IBN. Beyond the bandwidth of the AD9262, out-of-band peaking adds gain to the system, therefore requiring the input power to be scaled back to prevent in-band noise degradation. The input power is scaled back to a point where only 3 dB of noise degradation is allowed, therefore resulting in the response shown in Figure 62.

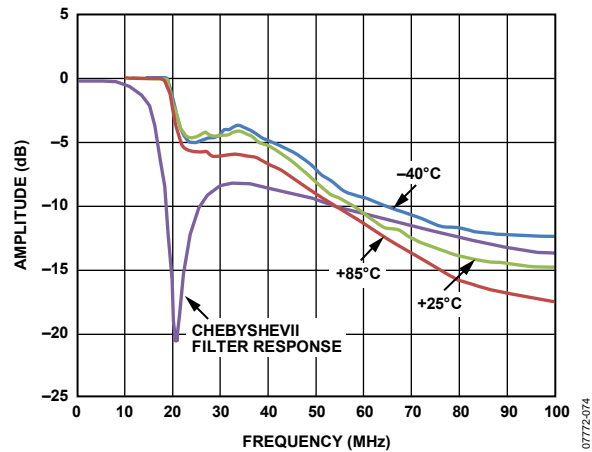

Figure 62. Maximum Input Level for 3 dB Noise Degradation

An example third-order, low-pass Chebyshev II type filter is shown in Figure 63. Table 24 summarizes the components and manufacturers used to build the circuit.

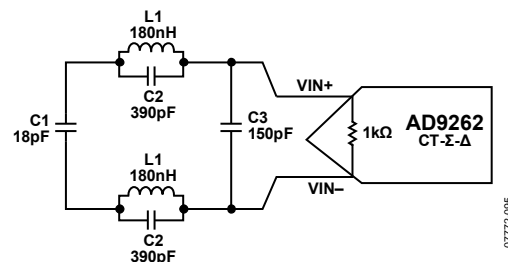

Figure 63. Third-Order, Low-Pass Chebyshev II Filter

Table 24. Chebyshev II Filter Components

Parameter	Value	Unit	Manufacturer
C1	18	pF	Murata GRM188 series, 0603
L1	180	nH	Coil Craft 0603 LS, 2%
C2	390	pF	Murata GRM188 series, 0603
C3	150	pF	Murata GRM188 series, 0603

In addition to matching the profile of Figure 62, group delay and channel matching are important filter design criteria. Low tolerance components are highly recommended for improved channel matching, which translates to minimal degradation in image rejection for quadrature systems.

MEMORY MAP

Table 25. Memory Map

Register Name	Address	Bit 7	Bit 6	Bit 5	Bit 4	Bit 3	Bit 2	Bit 1	Bit 0
SPI Port Config	0x00	0	LSBFIRST	SOFTRESET	1	1	SOFTRESET	LSBFIRST	0
Chip ID	0x01	CHIPID[7:0]							
Chip Grade	0x02		1	CHILDID[2:0]					
Channel Index	0x05							Channel[1:0]	
Power Modes	0x08							PWRDWN[1:0]	
PLLENABLE	0x09						PLLENABLE		
PLL	0x0A	PLLLOCKED	PLLAUTO	PLLMULT[5:0]					
Analog Input	0x0F		BW[1:0]						
Output Modes	0x14	DRVSTD		Interleave	OUTENB		OUTINV	Format[1:0]	
Output Adjust	0x15					DRVSTR33[1:0]		DRVSTR18[1:0]	
Output Clock	0x16	DCOINV							
Reference	0x18		EXTREF						
Output Data	0x101		QEC	KOUT[5:0]					
Overrange	0x111	AUTORST	OR_IND	ORTHRESH[5:0]					
QEC1	0x112			DCFRZ	PHASEFRZ	GAINFRZ	DCENB	PHASEENB	GAINENB
QEC2	0x113						DCFRC	PHASEFRC	GAINFRC

MEMORY MAP DEFINITIONS

Table 26. Memory Map Definitions

Register	Address	Bit(s)	Mnemonic	Default	Description
SPI Port Config	0x00	6, 1	LSBFIRST	0	0: serial interface uses MSB first format
		5, 2	SOFTRESET	0	1: serial interface uses LSB first format
Chip ID	0x01	[7:0]	CHIPID	0x22	0x22: AD9262
Chip Grade	0x02	[5:4]	CHILDID	0	0x00: 10 MHz bandwidth 0x10: 5 MHz bandwidth 0x20: 2.5 MHz bandwidth
Channel Index	0x05	[1:0]	Channel	0	0: both channels addressed simultaneously 1: Channel A only addressed 2: Channel B only addressed 3: both channels addressed simultaneously
Power Modes	0x08	[1:0]	PWRDWN	0	0x0: normal operation 0x1: power-down (local) 0x2: standby (everything except reference circuits) 0x3: sleep
PLLENABLE	0x09	2	PLLENABLE	0	1: enable PLL
PLL	0x0A	7	PLLLOCKED	0	0: PLL is not locked 1: PLL is locked
		6	PLLAUTO	0	1: PLL autoband enabled
		[5:0]	PLLMULT	0	See Table 10
Analog Input	0x0F	[6:5]	BW	0	See Table 13

Register	Address	Bit(s)	Mnemonic	Default	Description
Output Modes	0x14	7	DRVSTD	0	0: 3.3 V 1: 1.8 V
		5	Interleave	0	1: interleave both channels onto D[15:0]A
		4	OUTENB	0	1: data outputs tristated
		2	OUTINV	0	1: data outputs bitwise inverted
		[1:0]	Format	0	0: offset binary 1: twos complement 2: Gray code 3: offset binary
Output Adjust	0x15	[3:2]	DRVSTR33	0	Typical output sink current to DGND 0: 33 mA 1: 63 mA 2: 93 mA 3: 120 mA
		[1:0]	DRVSTR18	2	Typical output sink current to DGND 0: 10 mA 1: 20 mA 2: 30 mA 3: 39 mA
Output Clock	0x16	7	DCOINV	0	1: invert DCO
Reference	0x18	6	EXTREF	0	1: use external reference
Output Data	0x101	6	QEC	0	1: enable quadrature error correction
		[5:0]	KOUT	0	Output data rate, see Table 18
Overrange	0x111	7	AUTORST	0	1: enable loop filter reset indicator on ORx pin
		6	OR_IND	0	Refer to Table 21
		[5:0]	ORTHRESH	0	Refer to Table 20
QEC1	0x112	5	DCFRZ	0	1: freeze dc correction coefficients
		4	PHASEFRZ	0	1: freeze phase correction coefficients
		3	GAINFRZ	0	1: freeze gain correction coefficients
		2	DCENB	0	1: disable dc correction
		1	PHASEENB	0	1: disable phase correction
0	GAINENB	0	1: disable gain correction		
QEC2	0x113	2	DCFRC	0	1: force dc correction coefficients to initial static values
		1	PHASEFRC	0	1: force phase correction coefficients to initial static values
		0	GAINFRC	0	1: force gain correction coefficients to initial static values

OUTLINE DIMENSIONS

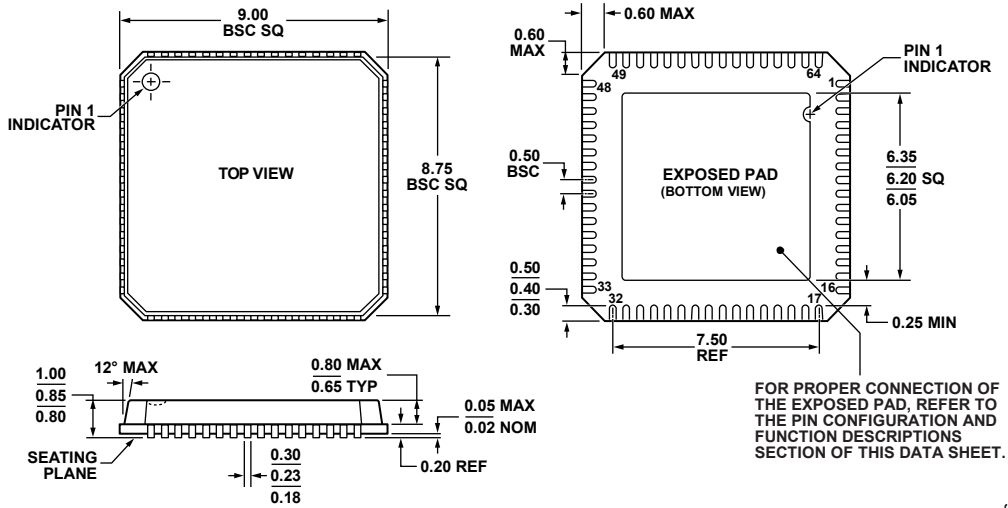

COMPLIANT TO JEDEC STANDARDS MO-220-VMM4

Figure 64. 64-Lead Lead Frame Chip Scale Package [LFCSP_VQ]
 9 mm × 9 mm Body, Very Thin Quad
 (CP-64-4)
 Dimensions shown in millimeters

081707-C

ORDERING GUIDE

Model ¹	Temperature Range	Package Description	Package Option
AD9262BCPZ-10	-40°C to +85°C	64-Lead Lead Frame Chip Scale Package [LFCSP_VQ]	CP-64-4
AD9262BCPZ-5	-40°C to +85°C	64-Lead Lead Frame Chip Scale Package [LFCSP_VQ]	CP-64-4
AD9262BCPZ	-40°C to +85°C	64-Lead Lead Frame Chip Scale Package [LFCSP_VQ]	CP-64-4
AD9262EBZ		Evaluation Board	
AD9262-5EBZ		Evaluation Board	
AD9262-10EBZ		Evaluation Board	

¹ Z = RoHS Compliant Part.

X-ON Electronics

Largest Supplier of Electrical and Electronic Components

Click to view similar products for [Analog to Digital Converters - ADC category](#):

Click to view products by [Analog Devices manufacturer](#):

Other Similar products are found below :

[ADC0804LCD](#) [ADC0808](#) [MCP37211-200I/TE](#) [MAX15511TGTL+](#) [MCP33141-10T-E/MS](#) [MCP33141D-05T-E/MS](#) [MCP33151D-05T-E/MS](#)
[MCP3202T-CI/MS](#) [MCP33141-05T-E/MS](#) [MCP33141D-10T-E/MS](#) [MCP33151-10T-E/MS](#) [ADE1201ACCZ](#) [ADE1202ACCZ](#) [LTC1090CN](#)
[LTC1605IG](#) [LTC1605AIG](#) [LTC2208IUP](#) [ADS1282HPW](#) [LTC1297DCN8](#) [LTC1741CFW](#) [MCP3422A0-E/MS](#) [MCP3426A2-E/MC](#)
[MCP3427-E/MF](#) [TLC0820ACN](#) [TLC2543IN](#) [TLV2543IDW](#) [NCD9830DBR2G](#) [ADS5231IPAG](#) [ADS7807U](#) [ADS7891IPFBT](#)
[ADS8328IBPW](#) [AMC1204BDWR](#) [ADS7959QDBTRQ1](#) [ADS7807UB](#) [ADS7805UB](#) [ADS1220IPWR](#) [MCP3426A0-E/MS](#) [MCP3423-E/UN](#)
[MCP3422A0-E/MC](#) [AD9220AR](#) [MAX11123ATI+](#) [MAX11212AEUB+](#) [MAX11207EEE+](#) [MAX11135ATI+](#) [TLV1570CDW](#)
[TLC3574IDWR](#) [TLC0838CDWR](#) [AD7714ARZ-5REEL](#) [AD7914BRUZ-REEL7](#) [AD977ABRZ](#)