

FEATURES

1.8 V analog supply operation

1.8 V to 3.3 V output supply

SNR

77.6 dBFS at 9.7 MHz input

71.1 dBFS at 200 MHz input

SFDR

93 dBc at 9.7 MHz input

80 dBc at 200 MHz input

Low power

56 mW at 20 MSPS

113 mW at 80 MSPS

Differential input with 700 MHz bandwidth

On-chip voltage reference and sample-and-hold circuit

2 V p-p differential analog input

DNL = $-0.6/+1.1$ LSB

Interleaved data output for reduced pin-count interface

Serial port control options

Offset binary, Gray code, or twos complement data format

Optional clock duty cycle stabilizer

Integer 1-to-8 input clock divider

Built-in selectable digital test pattern generation

Energy-saving power-down modes

Data clock output (DCO) with programmable clock and data alignment

APPLICATIONS

Communications

Diversity radio systems

Multimode digital receivers

GSM, EDGE, W-CDMA, LTE, CDMA2000, WiMAX, TD-SCDMA

Smart antenna systems

Battery-powered instruments

Handheld scope meters

Portable medical imaging

Ultrasound

Radar/LIDAR

PET/SPECT imaging

FUNCTIONAL BLOCK DIAGRAM

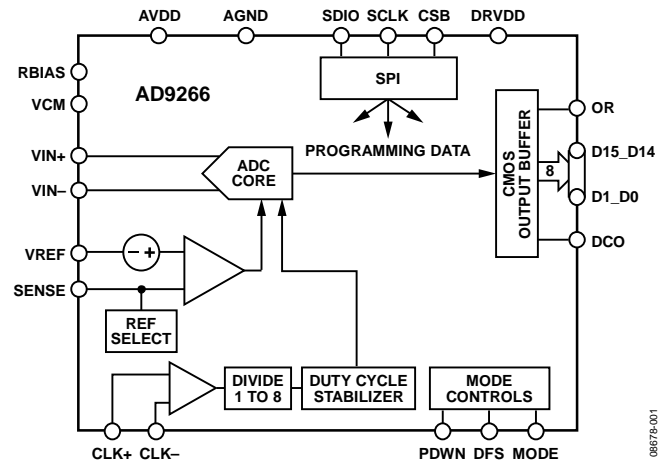

Figure 1.

PRODUCT HIGHLIGHTS

1. The **AD9266** operates from a single 1.8 V analog power supply and features a separate digital output driver supply to accommodate 1.8 V to 3.3 V logic families.
2. The sample-and-hold circuit maintains excellent performance for input frequencies up to 200 MHz and is designed for low cost, low power, and ease of use.
3. A standard serial port interface supports various product features and functions, such as data output formatting, internal clock divider, power-down, DCO and data output (D15_D14 to D1_D0) timing and offset adjustments, and voltage reference modes.
4. The **AD9266** is packaged in a 32-lead RoHS-compliant LFCSP that is pin compatible with the **AD9609** 10-bit ADC, the **AD9629** 12-bit ADC, and the **AD9649** 14-bit ADC, enabling a simple migration path between 10-bit and 16-bit converters sampling from 20 MSPS to 80 MSPS.

Rev. B

[Document Feedback](#)

Information furnished by Analog Devices is believed to be accurate and reliable. However, no responsibility is assumed by Analog Devices for its use, nor for any infringements of patents or other rights of third parties that may result from its use. Specifications subject to change without notice. No license is granted by implication or otherwise under any patent or patent rights of Analog Devices. Trademarks and registered trademarks are the property of their respective owners.

One Technology Way, P.O. Box 9106, Norwood, MA 02062-9106, U.S.A.
Tel: 781.329.4700 ©2010–2016 Analog Devices, Inc. All rights reserved.
[Technical Support](#) www.analog.com

TABLE OF CONTENTS

Features	1	Voltage Reference	19
Applications	1	Clock Input Considerations	20
Functional Block Diagram	1	Power Dissipation and Standby Mode	22
Product Highlights	1	Digital Outputs	22
Revision History	2	Timing	23
General Description	3	Output Test	24
Specifications	4	Output Test Modes	24
DC Specifications	4	Serial Port Interface (SPI)	25
AC Specifications	5	Configuration Using the SPI	25
Digital Specifications	6	Hardware Interface	26
Switching Specifications	7	Configuration Without the SPI	26
Timing Specifications	8	SPI Accessible Features	26
Absolute Maximum Ratings	9	Memory Map	27
Thermal Characteristics	9	Reading the Memory Map Register Table	27
ESD Caution	9	Open Locations	27
Pin Configuration and Function Descriptions	10	Default Values	27
Typical Performance Characteristics	11	Memory Map Register Table	28
AD9266-80	11	Memory Map Register Descriptions	30
AD9266-65	13	Applications Information	31
AD9266-40	14	Design Guidelines	31
AD9266-20	15	Outline Dimensions	32
Equivalent Circuits	16	Ordering Guide	32
Theory of Operation	17		
Analog Input Considerations	17		

REVISION HISTORY

3/16—Rev. A to Rev. B

Change to Product Highlights Section	1
Changes to Pipeline Delay (Latency) Parameter, Table 4	7
Changes to Figure 3 and Table 8	10
Changes to Clock Input Options Section	20
Changes to Data Clock Output Section	23

6/12—Rev. 0 to Rev. A

Changes to Table 1	4
Changes to Table 4	7
Changed Built-In Self-Test (BIST) and Output Test Section to Output Test Section	24
Changes to Output Test Section; Deleted Built-In Self-Test (BIST) Section	24
Changes to Table 16	28

4/10—Revision 0: Initial Version

GENERAL DESCRIPTION

The [AD9266](#) is a monolithic, single-channel 1.8 V supply, 16-bit, 20 MSPS/40 MSPS/65 MSPS/80 MSPS analog-to-digital converter (ADC). It features a high performance sample-and-hold circuit and on-chip voltage reference.

The product uses multistage differential pipeline architecture with output error correction logic to provide 16-bit accuracy at 80 MSPS data rates and to guarantee no missing codes over the full operating temperature range.

The ADC contains several features designed to maximize flexibility and minimize system cost, such as programmable clock and data alignment and programmable digital test pattern generation. The available digital test patterns include built-in deterministic and pseudorandom patterns, along with custom user-defined test patterns entered via the serial port interface (SPI).

A differential clock input with a selectable internal 1-to-8 divide ratio controls all internal conversion cycles. An optional duty cycle stabilizer (DCS) compensates for wide variations in the clock duty cycle while maintaining excellent overall ADC performance.

The interleaved digital output data is presented in offset binary, gray code, or twos complement format. A DCO is provided to ensure proper latch timing with receiving logic. Both 1.8 V and 3.3 V CMOS levels are supported.

The [AD9266](#) is available in a 32-lead RoHS-compliant LFCSP and is specified over the industrial temperature range (-40°C to $+85^{\circ}\text{C}$).

SPECIFICATIONS

DC SPECIFICATIONS

AVDD = 1.8 V; DRVDD = 1.8 V, maximum sample rate, 2 V p-p differential input, 1.0 V internal reference; AIN = -1.0 dBFS, 50% duty cycle clock, DCS disabled, unless otherwise noted.

Table 1.

Parameter	Temp	AD9266-20/AD9266-40			AD9266-65			AD9266-80			Unit
		Min	Typ	Max	Min	Typ	Max	Min	Typ	Max	
RESOLUTION	Full	16			16			16			Bits
ACCURACY		Guaranteed			Guaranteed			Guaranteed			
No Missing Codes	Full	Guaranteed			Guaranteed			Guaranteed			
Offset Error	Full		+0.05	±0.30		+0.05	±0.30		+0.05	±0.30	% FSR
Gain Error ¹	Full		-2.5/-2.0			-1.0			+1.0		% FSR
Differential Nonlinearity (DNL) ²	Full			-0.9/+1.2			-0.9/+1.7			-0.9/+1.7	LSB
	25°C		-0.5/+0.6			-0.5/+1.0			-0.6/+1.1		LSB
Integral Nonlinearity (INL) ²	Full			±5.5			±6.5			±6.2	LSB
	25°C			±1.8			±2.4			±3.5	LSB
TEMPERATURE DRIFT											
Offset Error	Full			±2			±2			±2	ppm/°C
INTERNAL VOLTAGE REFERENCE											
Output Voltage (1 V Mode)	Full	0.983	0.995	1.007	0.983	0.995	1.007	0.983	0.995	1.007	V
Load Regulation Error at 1.0 mA	Full		2			2			2		mV
INPUT-REFERRED NOISE											
VREF = 1.0 V	25°C		2.8			2.8			2.8		LSB rms
ANALOG INPUT											
Input Span, VREF = 1.0 V	Full		2			2			2		V p-p
Input Capacitance ³	Full		6.5			6.5			6.5		pF
Input Common-Mode Voltage	Full		0.9			0.9			0.9		V
Input Common-Mode Range	Full	0.5		1.3	0.5		1.3	0.5		1.3	V
REFERENCE INPUT RESISTANCE	Full		7.5			7.5			7.5		kΩ
POWER SUPPLIES											
Supply Voltage											
AVDD	Full	1.7	1.8	1.9	1.7	1.8	1.9	1.7	1.8	1.9	V
DRVDD	Full	1.7		3.6	1.7		3.6	1.7		3.6	V
Supply Current											
IAVDD ²	Full		31.4/40.7	33.2/42.5		54.5	57.6		62.5	65.7	mA
IDRVDD ² (1.8 V)	Full		1.7/3.3			5.2			6.3		mA
IDRVDD ² (3.3 V)	Full		3.0/5.9			9.3			11.6		mA
POWER CONSUMPTION											
DC Input	Full		57/73			98			113		mW
Sine Wave Input ² (DRVDD = 1.8 V)	Full		60/79	63/82		107	113		124	130	mW
Sine Wave Input ² (DRVDD = 3.3 V)	Full		66/93			129			151		mW
Standby Power ⁴	Full		40			44			44		mW
Power-Down Power	Full		0.5			0.5			0.5		mW

¹ Measured with 1.0 V external reference.

² Measured with a 10 MHz input frequency at rated sample rate, full-scale sine wave, with approximately 5 pF loading on each output bit.

³ Input capacitance refers to the effective capacitance between the differential inputs.

⁴ Standby power is measured with a dc input and the CLK active.

AC SPECIFICATIONS

AVDD = 1.8 V; DRVDD = 1.8 V, maximum sample rate, 2 V p-p differential input, 1.0 V internal reference; AIN = -1.0 dBFS, 50% duty cycle clock, DCS disabled, unless otherwise noted.

Table 2.

Parameter ¹	Temp	AD9266-20/AD9266-40			AD9266-65			AD9266-80			Unit
		Min	Typ	Max	Min	Typ	Max	Min	Typ	Max	
SIGNAL-TO-NOISE RATIO (SNR)	$f_{IN} = 9.7$ MHz	25°C		78.2		77.9		77.6		dBFS	
	$f_{IN} = 30.5$ MHz	25°C		77.6		77.5		77.3		dBFS	
	$f_{IN} = 70$ MHz	Full	76.7			76.6					dBFS
		25°C		75.8/76.4		76.6		76.6			dBFS
		Full						75.5			dBFS
$f_{IN} = 200$ MHz	25°C						72.1			dBFS	
SIGNAL-TO-NOISE-AND-DISTORTION (SINAD)	$f_{IN} = 9.7$ MHz	25°C		78.0		77.7		77.4		dBFS	
	$f_{IN} = 30.5$ MHz	25°C		77.5		77.3		77.1		dBFS	
	$f_{IN} = 70$ MHz	Full	76.2			76.2					dBFS
		25°C		75.7/76.3		76.5		76.6			dBFS
		Full						75.5			dBFS
$f_{IN} = 200$ MHz	25°C						69.4			dBFS	
EFFECTIVE NUMBER OF BITS (ENOB)	$f_{IN} = 9.7$ MHz	25°C		12.7		12.6		12.6		Bits	
	$f_{IN} = 30.5$ MHz	25°C		12.6		12.5		12.5		Bits	
	$f_{IN} = 70$ MHz	25°C		12.3/12.4		12.4		12.4		Bits	
	$f_{IN} = 200$ MHz	25°C						11.2		Bits	
WORST SECOND OR THIRD HARMONIC	$f_{IN} = 9.7$ MHz	25°C		-97		-96		-95		dBc	
	$f_{IN} = 30.5$ MHz	25°C		-96/-93		-94		-93		dBc	
		Full			-80		-80				dBc
		25°C		-97/-95		-98		-95			dBc
	$f_{IN} = 70$ MHz	Full						-80		dBc	
$f_{IN} = 200$ MHz	25°C						-80		dBc		
SPURIOUS-FREE DYNAMIC RANGE (SFDR)	$f_{IN} = 9.7$ MHz	25°C		95		95		94		dBc	
	$f_{IN} = 30.5$ MHz	25°C		93		92		92		dBc	
		Full	80			80					dBc
		25°C		93		95		93			dBc
	$f_{IN} = 200$ MHz	Full						80		dBc	
25°C							80		dBc		
WORST OTHER (HARMONIC OR SPUR)	$f_{IN} = 9.7$ MHz	25°C		-102		-101		-99		dBc	
	$f_{IN} = 30.5$ MHz	25°C		-102		-101		-98		dBc	
		Full			-89		-89				dBc
		25°C		-101		-100		-98			dBc
	$f_{IN} = 70$ MHz	Full						-89		dBc	
$f_{IN} = 200$ MHz	25°C						-86		dBc		
TWO-TONE SFDR											
$f_{IN} = 30.5$ MHz (-7 dBFS), 32.5 MHz (-7 dBFS)	25°C		90		90		90			dBc	
ANALOG INPUT BANDWIDTH	25°C		700		700		700			MHz	

¹ See the [AN-835 Application Note](#), *Understanding High Speed ADC Testing and Evaluation*, for a complete set of definitions.

DIGITAL SPECIFICATIONS

AVDD = 1.8 V; DRVDD = 1.8 V, maximum sample rate, 2 V p-p differential input, 1.0 V internal reference; AIN = -1.0 dBFS, 50% duty cycle clock, DCS disabled, unless otherwise noted.

Table 3.

Parameter	Temp	AD9266-20/AD9266-40/AD9266-65/AD9266-80			Unit
		Min	Typ	Max	
DIFFERENTIAL CLOCK INPUTS (CLK+, CLK-)					
Logic Compliance			CMOS/LVDS/LVPECL		
Internal Common-Mode Bias	Full		0.9		V
Differential Input Voltage	Full	0.2		3.6	V p-p
Input Voltage Range	Full	GND - 0.3		AVDD + 0.2	V
High Level Input Current	Full	-10		+10	μA
Low Level Input Current	Full	-10		+10	μA
Input Resistance	Full	8	10	12	kΩ
Input Capacitance	Full		4		pF
LOGIC INPUTS (SCLK/DFS, MODE, SDIO/PDWN)¹					
High Level Input Voltage	Full	1.2		DRVDD + 0.3	V
Low Level Input Voltage	Full	0		0.8	V
High Level Input Current	Full	-50		-75	μA
Low Level Input Current	Full	-10		+10	μA
Input Resistance	Full		30		kΩ
Input Capacitance	Full		2		pF
LOGIC INPUTS (CSB)²					
High Level Input Voltage	Full	1.2		DRVDD + 0.3	V
Low Level Input Voltage	Full	0		0.8	V
High Level Input Current	Full	-10		+10	μA
Low Level Input Current	Full	40		135	μA
Input Resistance	Full		26		kΩ
Input Capacitance	Full		2		pF
DIGITAL OUTPUTS					
DRVDD = 3.3 V					
High Level Output Voltage, I _{OH} = 50 μA	Full	3.29			V
High Level Output Voltage, I _{OH} = 0.5 mA	Full	3.25			V
Low Level Output Voltage, I _{OL} = 1.6 mA	Full			0.2	V
Low Level Output Voltage, I _{OL} = 50 μA	Full			0.05	V
DRVDD = 1.8 V					
High Level Output Voltage, I _{OH} = 50 μA	Full	1.79			V
High Level Output Voltage, I _{OH} = 0.5 mA	Full	1.75			V
Low Level Output Voltage, I _{OL} = 1.6 mA	Full			0.2	V
Low Level Output Voltage, I _{OL} = 50 μA	Full			0.05	V

¹ Internal 30 kΩ pull-down.

² Internal 30 kΩ pull-up.

SWITCHING SPECIFICATIONS

AVDD = 1.8 V; DRVDD = 1.8 V, maximum sample rate, 2 V p-p differential input, 1.0 V internal reference; AIN = -1.0 dBFS, 50% duty cycle clock, DCS disabled, unless otherwise noted.

Table 4.

Parameter	Temp	AD9266-20/AD9266-40			AD9266-65			AD9266-80			Unit
		Min	Typ	Max	Min	Typ	Max	Min	Typ	Max	
CLOCK INPUT PARAMETERS											
Input Clock Rate	Full			80/320			520			625	MHz
Conversion Rate ¹	Full	3		20/40	3		65	3		80	MSPS
CLK Period—Divide-by-1 Mode (t_{CLK})	Full	50/25			15.38			12.5			ns
CLK Pulse Width High (t_{CH})			25.0/12.5			7.69			6.25		ns
Aperture Delay (t_A)	Full		1.0			1.0			1.0		ns
Aperture Uncertainty (Jitter, t_j)	Full		0.1			0.1			0.1		ps rms
DATA OUTPUT PARAMETERS											
Data Propagation Delay (t_{PD})	Full	1.84	3	3.90	1.84	3	3.90	1.84	3	3.90	ns
DCO Propagation Delay (t_{DCO})	Full	1.86	3	4.04	1.86	3	4.04	1.86	3	4.04	ns
DCO to Data Skew (t_{SKEW})	Full	-0.53	0.1	0.72	-0.53	0.1	0.72	-0.53	0.1	0.72	ns
Pipeline Delay (Latency)	Full		8			8			8		Cycles
Wake-Up Time ²	Full		350			350			350		μ s
Standby	Full		600/400			300			260		ns
OUT-OF-RANGE RECOVERY TIME	Full		2			2			2		Cycles

¹ Conversion rate is the clock rate after the CLK divider.

² Wake-up time is dependent on the value of the decoupling capacitors.

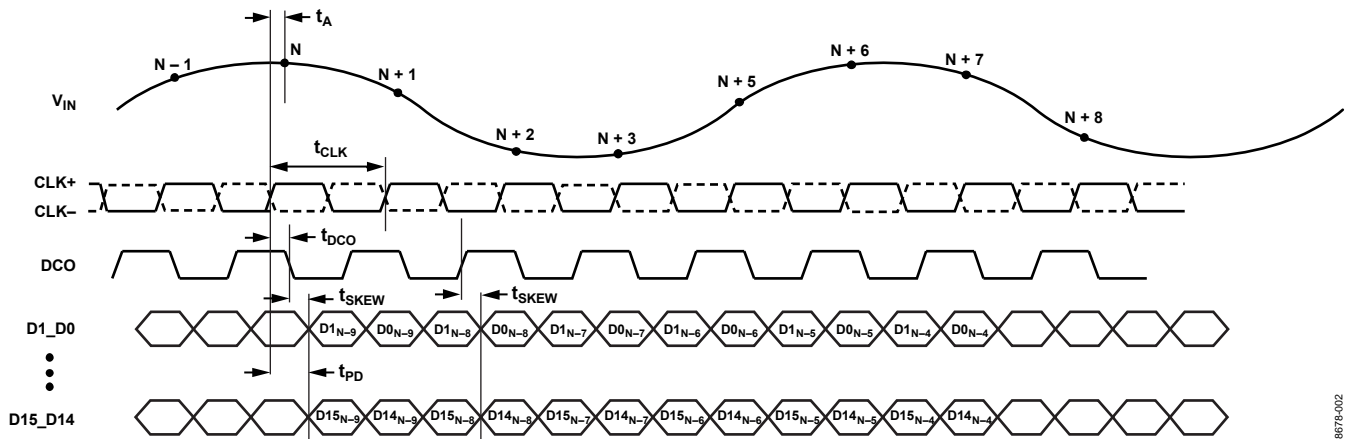

Figure 2. CMOS Output Data Timing

08676-002

TIMING SPECIFICATIONS

Table 5.

Parameter	Test Conditions/Comments	Min	Typ	Max	Unit
SPI TIMING REQUIREMENTS					
t _{DS}	Setup time between the data and the rising edge of SCLK	2			ns
t _{DH}	Hold time between the data and the rising edge of SCLK	2			ns
t _{CLK}	Period of the SCLK	40			ns
t _S	Setup time between CSB and SCLK	2			ns
t _H	Hold time between CSB and SCLK	2			ns
t _{HIGH}	SCLK pulse width high	10			ns
t _{LOW}	SCLK pulse width low	10			ns
t _{EN_SDIO}	Time required for the SDIO pin to switch from an input to an output relative to the SCLK falling edge	10			ns
t _{DIS_SDIO}	Time required for the SDIO pin to switch from an output to an input relative to the SCLK rising edge	10			ns

ABSOLUTE MAXIMUM RATINGS

Table 6.

Parameter	Rating
AVDD to AGND	−0.3 V to +2.0 V
DRVDD to AGND	−0.3 V to +3.9 V
VIN+, VIN− to AGND	−0.3 V to AVDD + 0.2 V
CLK+, CLK− to AGND	−0.3 V to AVDD + 0.2 V
VREF to AGND	−0.3 V to AVDD + 0.2 V
SENSE to AGND	−0.3 V to AVDD + 0.2 V
VCM to AGND	−0.3 V to AVDD + 0.2 V
RBIAS to AGND	−0.3 V to AVDD + 0.2 V
CSB to AGND	−0.3 V to DRVDD + 0.3 V
SCLK/DFS to AGND	−0.3 V to DRVDD + 0.3 V
SDIO/PDWN to AGND	−0.3 V to DRVDD + 0.3 V
MODE/OR to AGND	−0.3 V to DRVDD + 0.3 V
D1_D0 Through D15_D14 to AGND	−0.3 V to DRVDD + 0.3 V
DCO to AGND	−0.3 V to DRVDD + 0.3 V
Operating Temperature Range (Ambient)	−40°C to +85°C
Maximum Junction Temperature Under Bias	150°C
Storage Temperature Range (Ambient)	−65°C to +150°C

Stresses at or above those listed under Absolute Maximum Ratings may cause permanent damage to the product. This is a stress rating only; functional operation of the product at these or any other conditions above those indicated in the operational section of this specification is not implied. Operation beyond the maximum operating conditions for extended periods may affect product reliability.

THERMAL CHARACTERISTICS

The exposed paddle is the only ground connection for the chip. The exposed paddle must be soldered to the AGND plane of the user's circuit board. Soldering the exposed paddle to the user's board also increases the reliability of the solder joints and maximizes the thermal capability of the package.

Table 7. Thermal Resistance

Package Type	Airflow Velocity (m/sec)	$\theta_{JA}^{1,2}$	$\theta_{JC}^{1,3}$	$\theta_{JB}^{1,4}$	$\Psi_{JT}^{1,2}$	Unit
32-Lead LFCSP, 5 mm × 5 mm	0	37.1	3.1	20.7	0.3	°C/W
	1.0	32.4			0.5	°C/W
	2.5	29.1			0.8	°C/W

¹ Per JEDEC 51-7, plus JEDEC 51-5 2S2P test board.

² Per JEDEC JESD51-2 (still air) or JEDEC JESD51-6 (moving air).

³ Per MIL-Std 883, Method 1012.1.

⁴ Per JEDEC JESD51-8 (still air).

Typical θ_{JA} is specified for a 4-layer PCB with a solid ground plane. As shown in Table 7, airflow improves heat dissipation, which reduces θ_{JA} . In addition, metal in direct contact with the package leads from metal traces, through holes, ground, and power planes reduces the θ_{JA} .

ESD CAUTION



ESD (electrostatic discharge) sensitive device. Charged devices and circuit boards can discharge without detection. Although this product features patented or proprietary protection circuitry, damage may occur on devices subjected to high energy ESD. Therefore, proper ESD precautions should be taken to avoid performance degradation or loss of functionality.

PIN CONFIGURATION AND FUNCTION DESCRIPTIONS

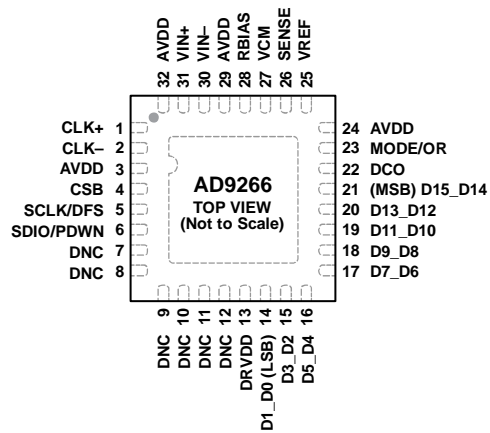

NOTES

1. DNC = DO NOT CONNECT.
2. THE EXPOSED PADDLE IS THE ONLY GROUND CONNECTION ON THE DEVICE. IT MUST BE SOLDERED TO THE ANALOG GROUND OF THE PCB TO ENSURE PROPER FUNCTIONALITY, HEAT DISSIPATION, NOISE, AND MECHANICAL STRENGTH.

08678-003

Figure 3. Pin Configuration

Table 8. Pin Function Descriptions

Pin No.	Mnemonic	Description
0	EPAD	Exposed Paddle. The exposed paddle is the only ground connection on the device. It must be soldered to the analog ground of the PCB to ensure proper functionality, heat dissipation, noise, and mechanical strength.
1, 2	CLK+, CLK-	Differential Encode Clock for PECL, LVDS, or 1.8 V CMOS Inputs.
3, 24, 29, 32	AVDD	1.8 V Supply Pin for ADC Core Domain.
4	CSB	SPI Chip Select. Active low enable, 30 k Ω internal pull-up.
5	SCLK/DFS	SPI Clock Input in SPI Mode (SCLK). 30 k Ω internal pull-down. Data Format Select in Non-SPI Mode (DFS). Static control of data output format. 30 k Ω internal pull-down. DFS high = twos complement output; DFS low = offset binary output.
6	SDIO/PDWN	SPI Data Input/Output (SDIO). Bidirectional SPI data I/O with 30 k Ω internal pull-down. Non-SPI Mode Power-Down (PDWN). Static control of chip power-down with 30 k Ω internal pull-down. See Table 14 for details.
7 to 12	DNC	Do Not Connect.
14 to 21	D1_D0 (LSB) to (MSB) D15_D14	ADC Digital Outputs.
13	DRVDD	1.8 V to 3.3 V Supply Pin for Output Driver Domain.
22	DCO	Data Clock Digital Output.
23	MODE/OR	Chip Mode Select Input (MODE)/Out-of-Range Digital Output in SPI Mode (OR). Default = out-of-range (OR) digital output (SPI Register 0x2A, Bit 0 = 1). Option = chip mode select input (SPI Register 0x2A, Bit 0 = 0). Chip power-down (SPI Register 0x08, Bits[7:5] = 100b). Chip standby (SPI Register 0x08, Bits[7:5] = 101b). Normal operation, output disabled (SPI Register 0x08, Bits[7:5] = 110b). Normal operation, output enabled (SPI Register 0x08, Bits[7:5] = 111b). Out-of-range (OR) digital output only in non-SPI mode.
25	VREF	1.0 V Voltage Reference Input/Output. See Table 10.
26	SENSE	Reference Mode Selection. See Table 10.
27	VCM	Analog Output Voltage at Mid AVDD Supply. Sets common mode of the analog inputs.
28	RBIAS	Set Analog Current Bias. Connect to 10 k Ω (1% tolerance) resistor to ground.
30, 31	VIN-, VIN+	ADC Analog Inputs.

TYPICAL PERFORMANCE CHARACTERISTICS

AD9266-80

AVDD = 1.8 V; DRVDD = 1.8 V, maximum sample rate, 2 V p-p differential input, 1.0 V internal reference; AIN = -1.0 dBFS, 50% duty cycle clock, DCS disabled, unless otherwise noted.

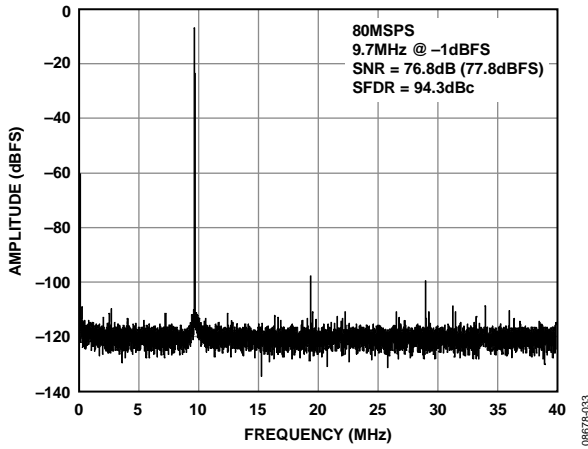

Figure 4. AD9266-80 Single-Tone FFT with $f_{IN} = 9.7$ MHz

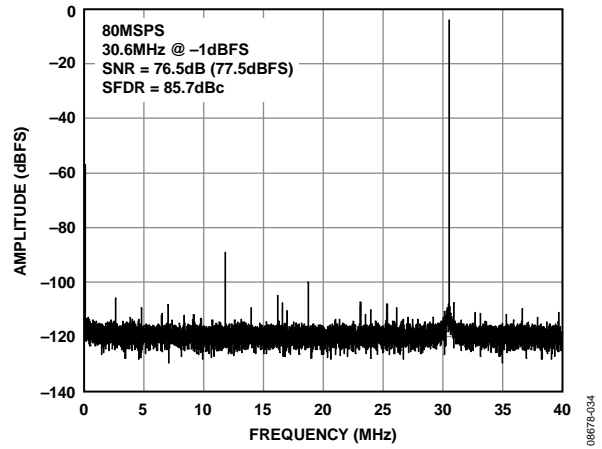

Figure 7. AD9266-80 Single-Tone FFT with $f_{IN} = 30.6$ MHz

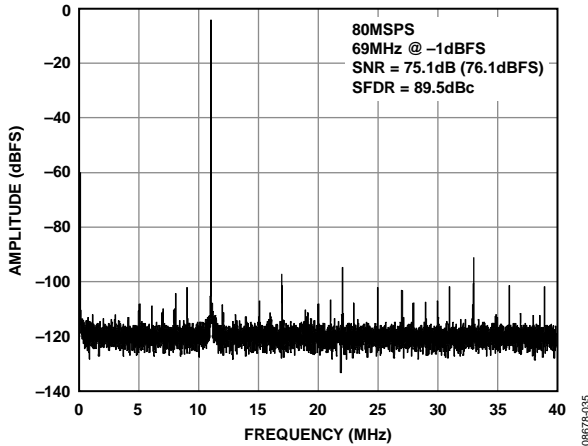

Figure 5. AD9266-80 Single-Tone FFT with $f_{IN} = 69$ MHz

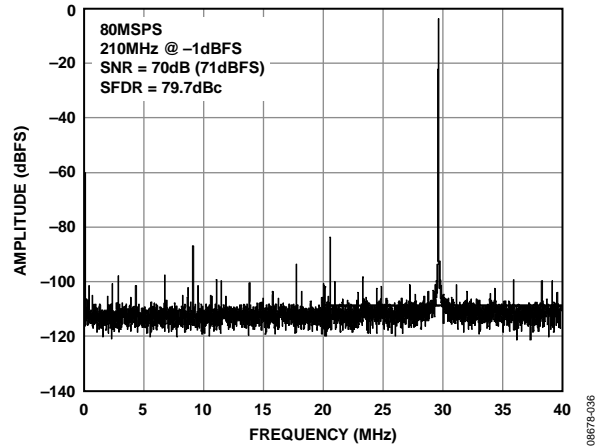

Figure 8. AD9266-80 Single-Tone FFT with $f_{IN} = 210$ MHz

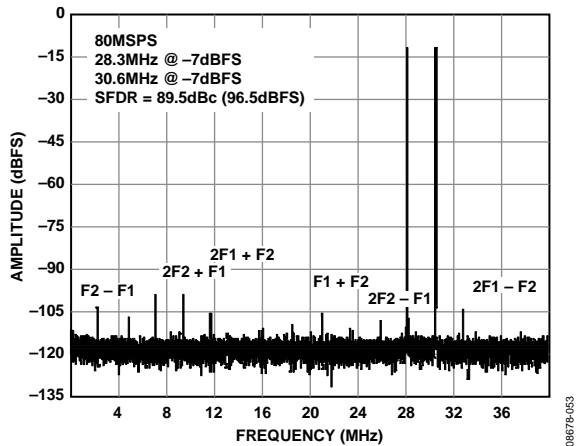

Figure 6. AD9266-80 Two-Tone FFT with $f_{IN1} = 28.3$ MHz and $f_{IN2} = 30.6$ MHz

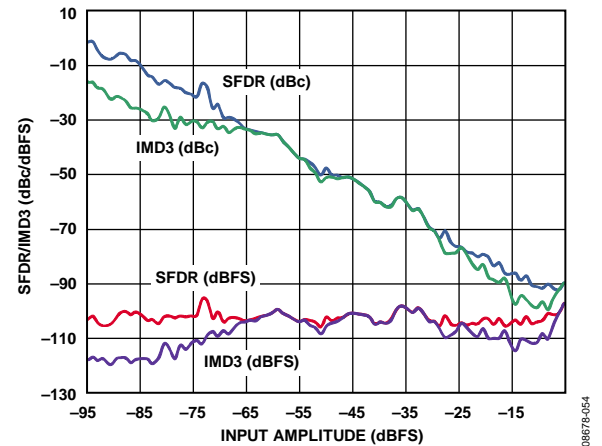

Figure 9. Two-Tone SFDR/IMD3 vs. Input Amplitude (A_{IN}) with $f_{IN1} = 28.3$ MHz and $f_{IN2} = 30.6$ MHz

AVDD = 1.8 V; DRVDD = 1.8 V, maximum sample rate, 2 V p-p differential input, 1.0 V internal reference; AIN = -1.0 dBFS, 50% duty cycle clock, DCS disabled, unless otherwise noted.

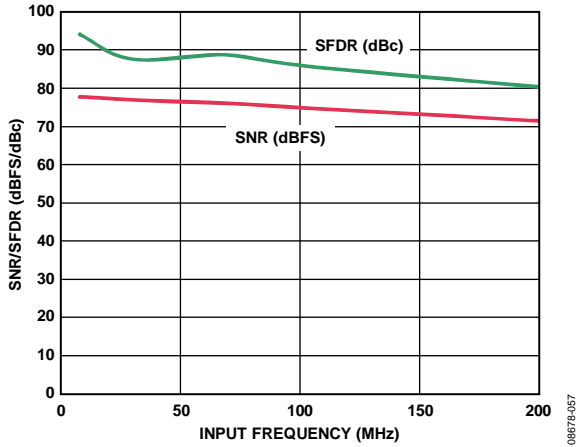

Figure 10. AD9266-80 SNR/SFDR vs. Input Frequency (AIN) with 2 V p-p Full Scale

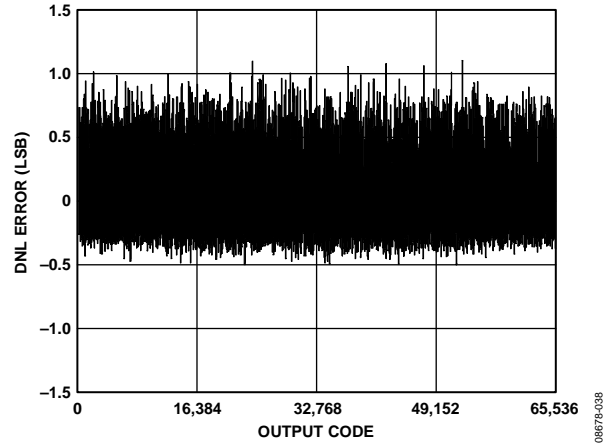

Figure 13. DNL Error with $f_{IN} = 9.7$ MHz

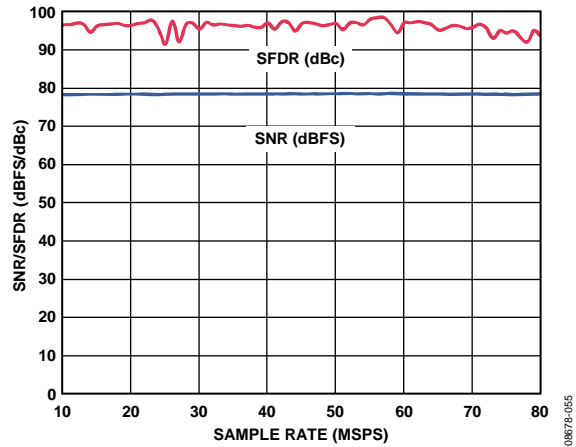

Figure 11. AD9266-80 SNR/SFDR vs. Sample Rate with AIN = 9.7 MHz

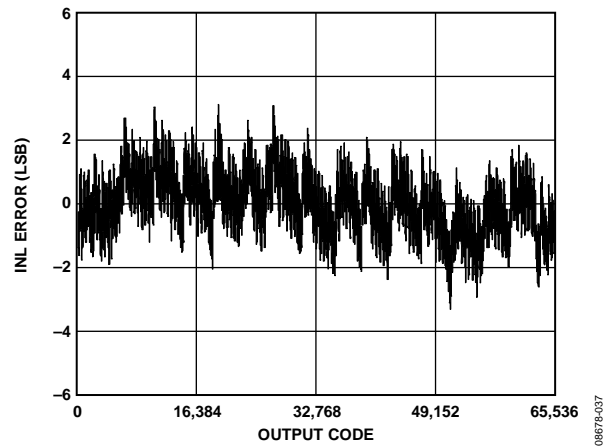

Figure 14. INL with $f_{IN} = 9.7$ MHz

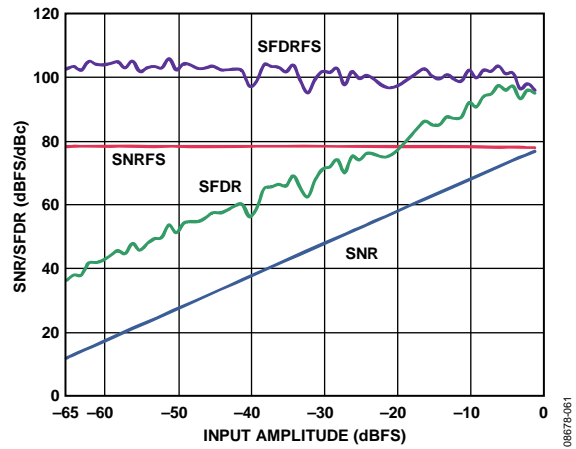

Figure 12. AD9266-80 SNR/SFDR vs. Input Amplitude (AIN) with $f_{IN} = 9.7$ MHz

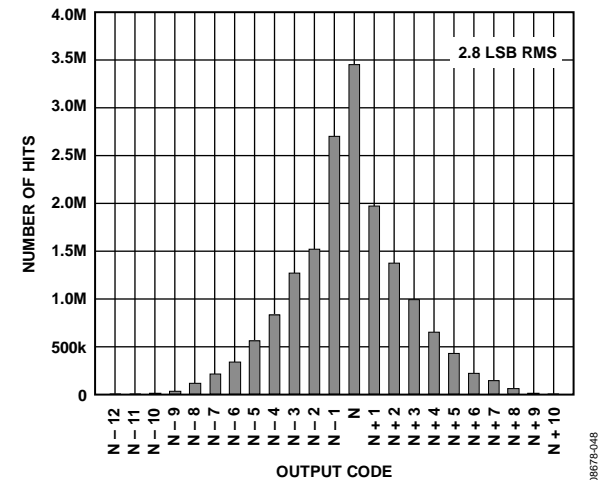

Figure 15. Grounded Input Histogram

AD9266-65

AVDD = 1.8 V; DRVDD = 1.8 V, maximum sample rate, 2 V p-p differential input, 1.0 V internal reference; AIN = -1.0 dBFS, 50% duty cycle clock, DCS disabled, unless otherwise noted.

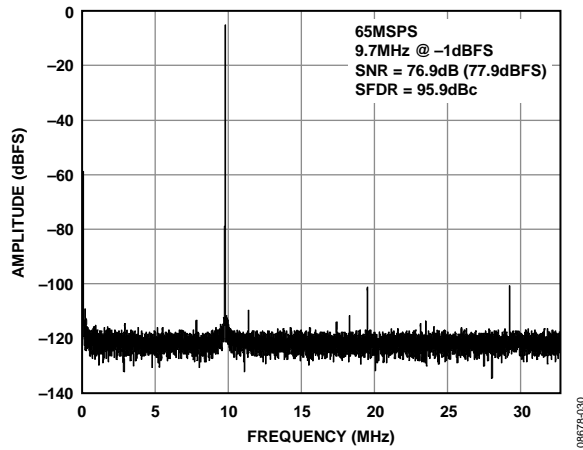

Figure 16. AD9266-65 Single-Tone FFT with $f_{IN} = 9.7$ MHz

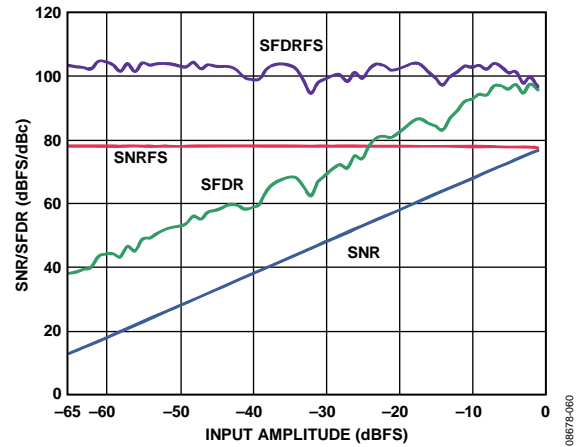

Figure 19. AD9266-65 SNR/SFDR vs. Input Amplitude (AIN) with $f_{IN} = 9.7$ MHz

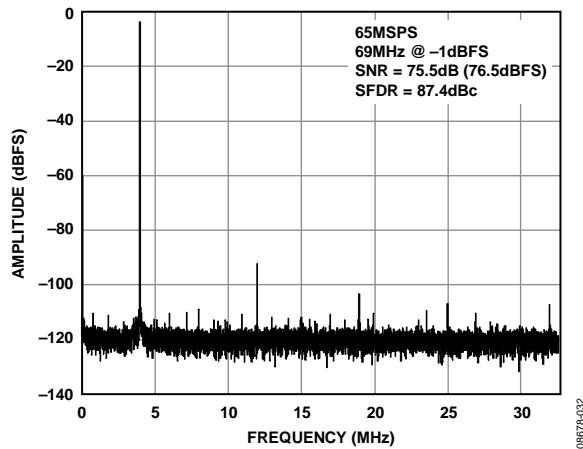

Figure 17. AD9266-65 Single-Tone FFT with $f_{IN} = 69$ MHz

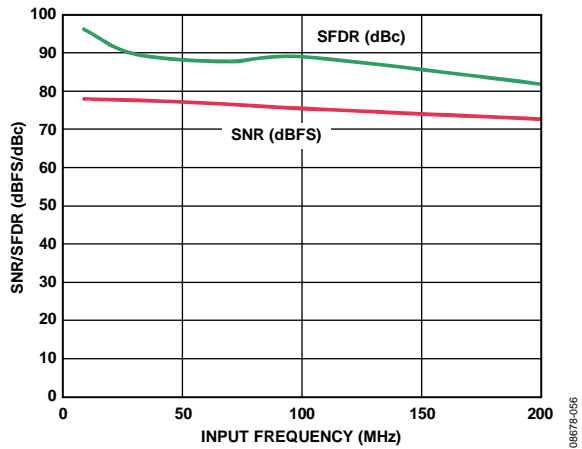

Figure 20. AD9266-65 SNR/SFDR vs. Input Frequency (AIN) with 2 V p-p Full Scale

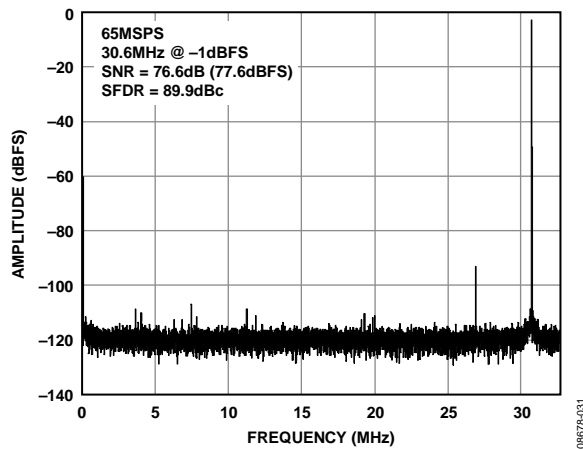

Figure 18. AD9266-65 Single-Tone FFT with $f_{IN} = 30.6$ MHz

AD9266-40

AVDD = 1.8 V; DRVDD = 1.8 V, maximum sample rate, 2 V p-p differential input, 1.0 V internal reference; AIN = -1.0 dBFS, 50% duty cycle clock, DCS disabled, unless otherwise noted.

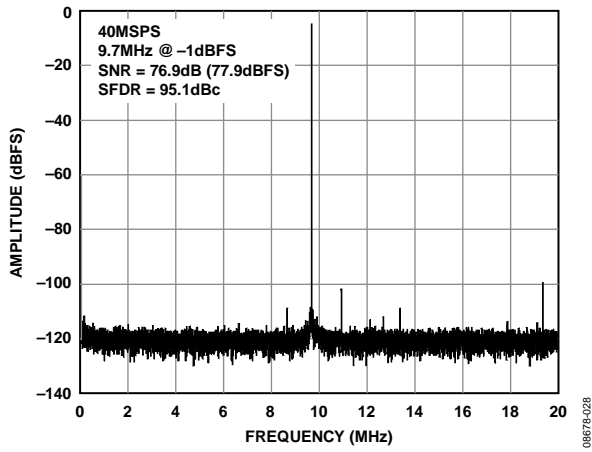

Figure 21. AD9266-40 Single-Tone FFT with $f_{IN} = 9.7$ MHz

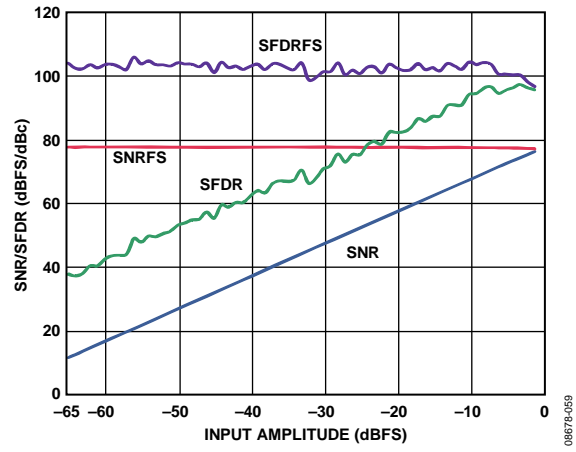

Figure 23. AD9266-40 SNR/SFDR vs. Input Amplitude (AIN) with $f_{IN} = 9.7$ MHz

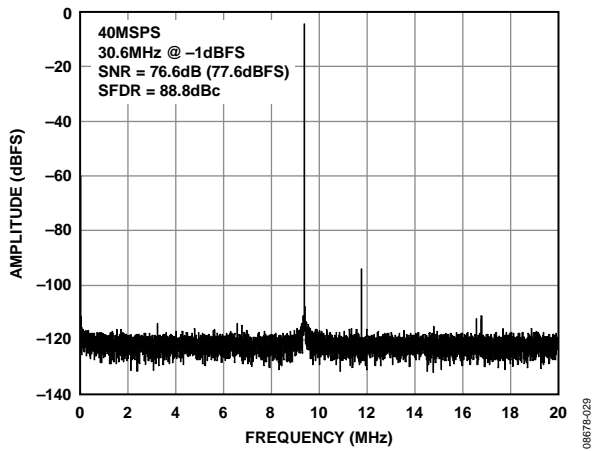

Figure 22. AD9266-40 Single-Tone FFT with $f_{IN} = 30.6$ MHz

AD9266-20

AVDD = 1.8 V; DRVDD = 1.8 V, maximum sample rate, 2 V p-p differential input, 1.0 V internal reference; AIN = -1.0 dBFS, 50% duty cycle clock, DCS disabled, unless otherwise noted.

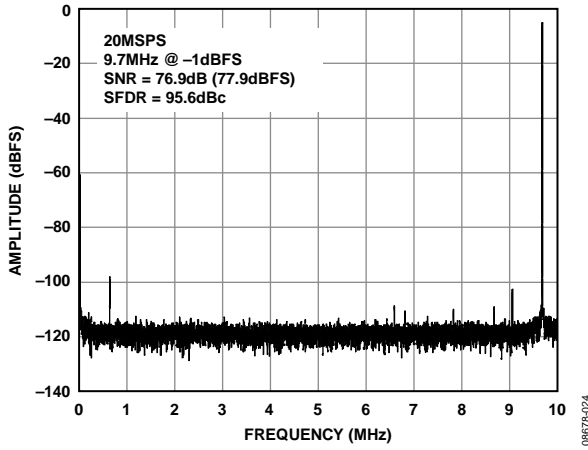

Figure 24. AD9266-20 Single-Tone FFT with $f_{IN} = 9.7$ MHz

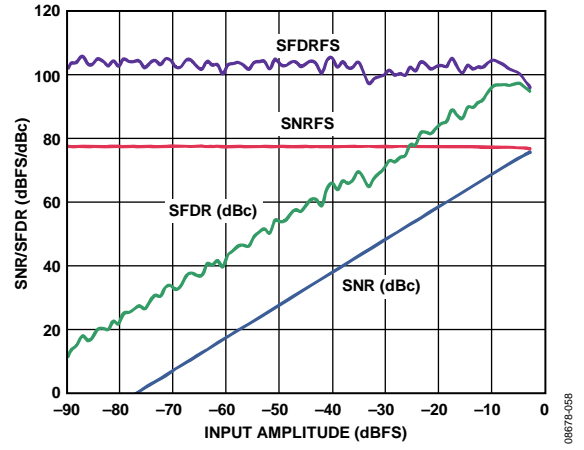

Figure 26. AD9266-20 SNR/SFDR vs. Input Amplitude (AIN) with $f_{IN} = 9.7$ MHz

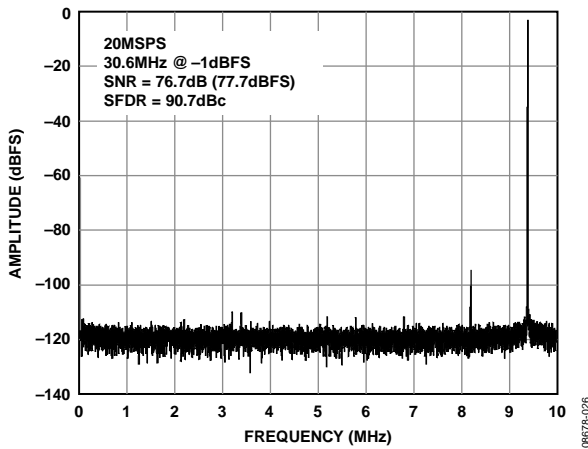

Figure 25. AD9266-20 Single-Tone FFT with $f_{IN} = 30.6$ MHz

EQUIVALENT CIRCUITS

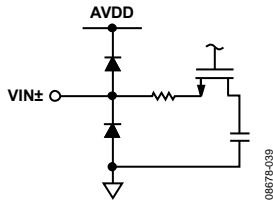

Figure 27. Equivalent Analog Input Circuit

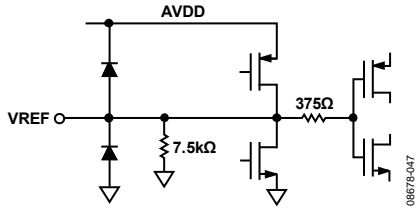

Figure 28. Equivalent VREF Circuit

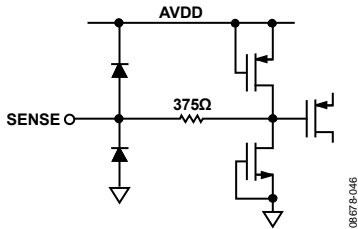

Figure 29. Equivalent SENSE Circuit

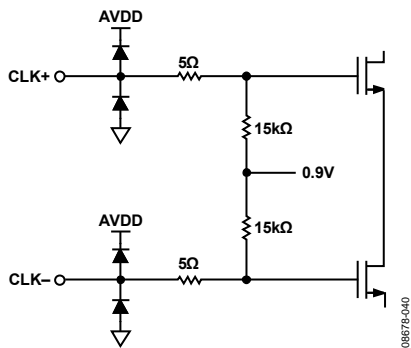

Figure 30. Equivalent Clock Input Circuit

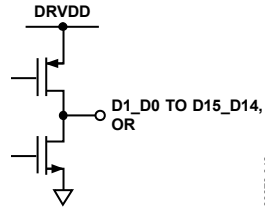

Figure 31. Equivalent D1_D0 to D15_D14 and OR Digital Output Circuit

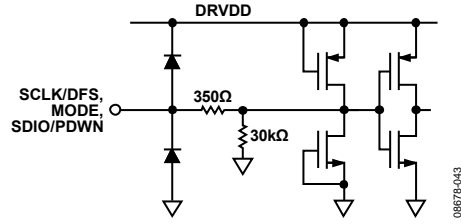

Figure 32. Equivalent SCLK/DFS, MODE, and SDIO/PDWN Input Circuit

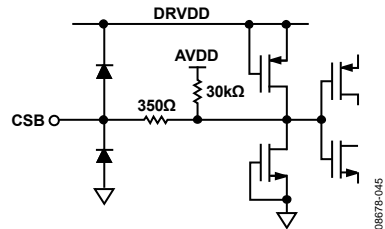

Figure 33. Equivalent CSB Input Circuit

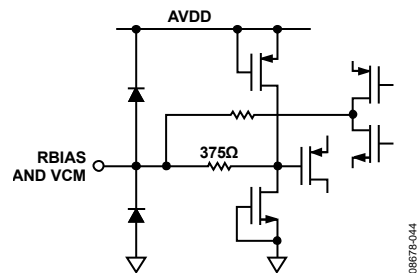

Figure 34. Equivalent RBIAS and VCM Circuit

THEORY OF OPERATION

The AD9266 architecture consists of a multistage, pipelined ADC. Each stage provides sufficient overlap to correct for flash errors in the preceding stage. The quantized outputs from each stage are combined into a final 16-bit result in the digital correction logic. The pipelined architecture permits the first stage to operate with a new input sample, whereas the remaining stages operate with preceding samples. Sampling occurs on the rising edge of the clock.

Each stage of the pipeline, excluding the last, consists of a low resolution flash ADC connected to a switched-capacitor DAC and an interstage residue amplifier (for example, a multiplying digital-to-analog converter (MDAC)). The residue amplifier magnifies the difference between the reconstructed DAC output and the flash input for the next stage in the pipeline. One bit of redundancy is used in each stage to facilitate digital correction of flash errors. The last stage simply consists of a flash ADC.

The output staging block aligns the data, corrects errors, and passes the data to the CMOS output buffers. The output buffers are powered from a separate (DRVDD) supply, allowing adjustment of the output voltage swing. During power-down, the output buffers go into a high impedance state.

ANALOG INPUT CONSIDERATIONS

The analog input to the AD9266 is a differential switched-capacitor circuit designed for processing differential input signals. This circuit can support a wide common-mode range while maintaining excellent performance. By using an input common-mode voltage of midsupply, users can minimize signal-dependent errors and achieve optimum performance.

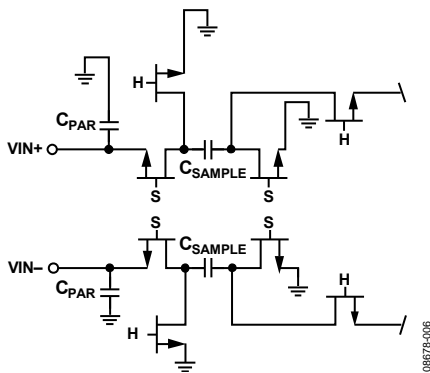

Figure 35. Switched-Capacitor Input Circuit

The clock signal alternately switches the input circuit between sample-and-hold mode (see Figure 35). When the input circuit is switched to sample mode, the signal source must be capable of charging the sample capacitors and settling within one-half of a clock cycle. A small resistor in series with each input can help reduce the peak transient current injected from the output stage of the driving source. In addition, low Q inductors or ferrite beads can be placed on each leg of the input to reduce high differential capacitance at the analog inputs and, therefore, achieve the maximum bandwidth of the ADC. Such use of low Q inductors or ferrite beads is required when driving the converter front end at

high IF frequencies. Either a shunt capacitor or two single-ended capacitors can be placed on the inputs to provide a matching passive network. This ultimately creates a low-pass filter at the input to limit unwanted broadband noise. See the AN-742 Application Note, the AN-827 Application Note, and the Analog Dialogue article “Transformer-Coupled Front-End for Wideband A/D Converters” (Volume 39, April 2005) for more information. In general, the precise values depend on the application.

Input Common Mode

The analog inputs of the AD9266 are not internally dc-biased. Therefore, in ac-coupled applications, the user must provide a dc bias externally. Setting the device so that $V_{CM} = AV_{DD}/2$ is recommended for optimum performance, but the device can function over a wider range with reasonable performance, as shown in Figure 36.

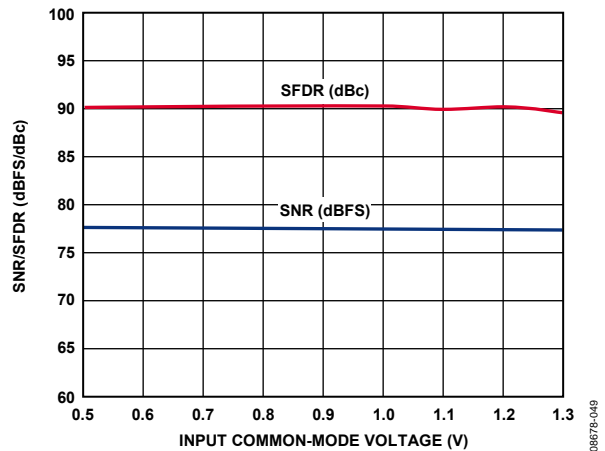

Figure 36. SNR/SFDR vs. Input Common-Mode Voltage, $f_{IN} = 32.5$ MHz, $f_s = 80$ MS/PS

An on-board, common-mode voltage reference is included in the design and is available from the VCM pin. The VCM pin must be decoupled to ground by a 0.1 μ F capacitor, as described in the Applications Information section.

Differential Input Configurations

Optimum performance is achieved while driving the AD9266 in a differential input configuration. For baseband applications, the AD8138, ADA4937-2, and ADA4938-2 differential drivers provide excellent performance and a flexible interface to the ADC.

The output common-mode voltage of the ADA4938-2 is easily set with the VCM pin of the AD9266 (see Figure 37), and the driver can be configured in a Sallen-Key filter topology to provide band limiting of the input signal.

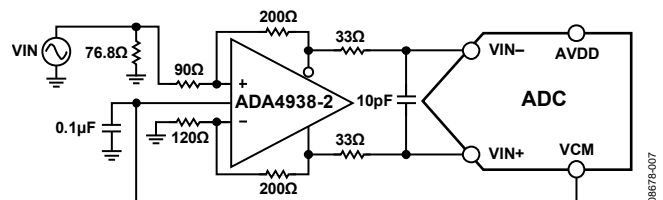

Figure 37. Differential Input Configuration Using the ADA4938-2

For baseband applications less than approximately 10 MHz where SNR is a key parameter, differential transformer coupling is the recommended input configuration. An example is shown in Figure 38. To bias the analog input, the VCM voltage can be connected to the center tap of the secondary winding of the transformer.

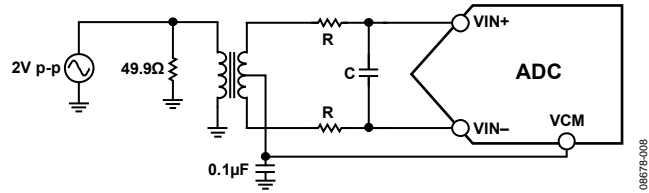

Figure 38. Differential Transformer-Coupled Configuration

The signal characteristics must be considered when selecting a transformer. Most RF transformers saturate at frequencies below a few megahertz (MHz). Excessive signal power can also cause core saturation, which leads to distortion.

At input frequencies in the second Nyquist zone and above, the noise performance of most amplifiers is not adequate to achieve the true SNR performance of the AD9266. For applications greater than approximately 10 MHz where SNR is a key parameter, differential double balun coupling is the recommended input configuration (see Figure 40).

An alternative to using a transformer-coupled input at frequencies in the second Nyquist zone is to use the AD8352 differential driver. An example is shown in Figure 41. See the AD8352 data sheet for more information.

In any configuration, the value of Shunt Capacitor C is dependent on the input frequency and source impedance and may need to be reduced or removed. Table 9 displays the suggested values to set the RC network. However, these values are dependent on the input signal and should be used only as a starting guide.

Table 9. Example RC Network

Frequency Range (MHz)	R Series (Ω Each)	C Differential (pF)
0 to 70	33	22
70 to 200	125	Open

Single-Ended Input Configuration

A single-ended input can provide adequate performance in cost-sensitive applications. In this configuration, SFDR and distortion performance degrade due to the large input common-mode swing. If the source impedances on each input are matched, there should be little effect on SNR performance. Figure 39 shows a typical single-ended input configuration.

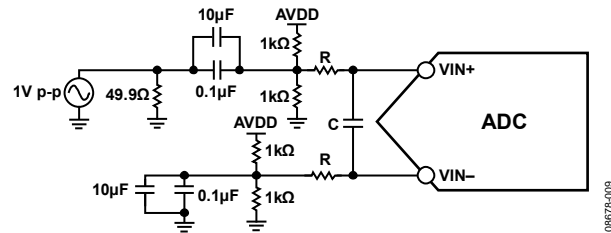

Figure 39. Single-Ended Input Configuration

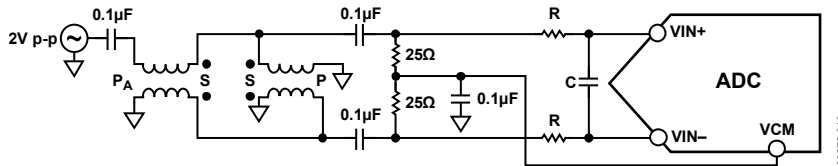

Figure 40. Differential Double Balun Input Configuration

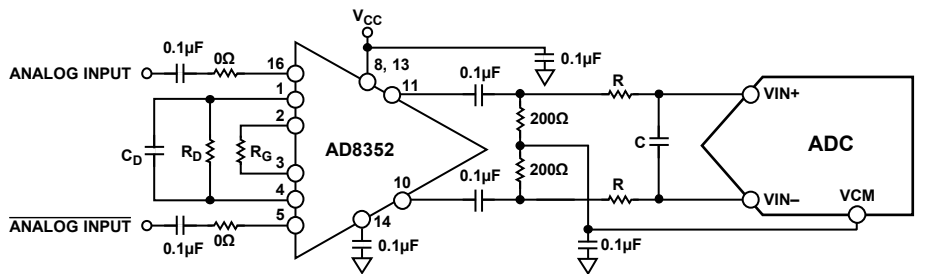

Figure 41. Differential Input Configuration Using the AD8352

VOLTAGE REFERENCE

A stable and accurate 1.0 V voltage reference is built into the AD9266. The VREF can be configured using either the internal 1.0 V reference or an externally applied 1.0 V reference. The various reference modes are summarized in the sections that follow. The Reference Decoupling section describes the best practices for PCB layout of VREF.

Internal Reference Connection

A comparator within the AD9266 detects the potential at the SENSE pin and configures the reference into two possible modes, which are summarized in Table 10. If SENSE is grounded, the reference amplifier switch is connected to the internal resistor divider (see Figure 42), setting VREF to 1.0 V.

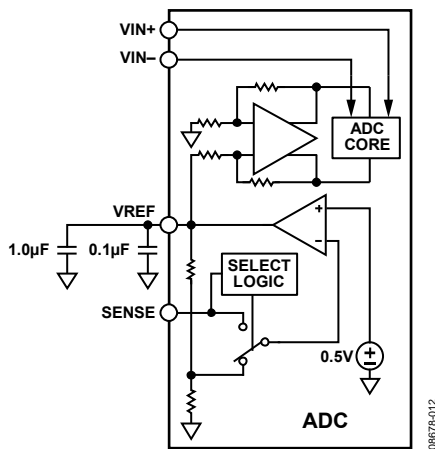

Figure 42. Internal Reference Configuration

If the internal reference of the AD9266 is used to drive multiple converters to improve gain matching, the loading of the reference by the other converters must be considered. Figure 43 shows how the internal reference voltage is affected by loading.

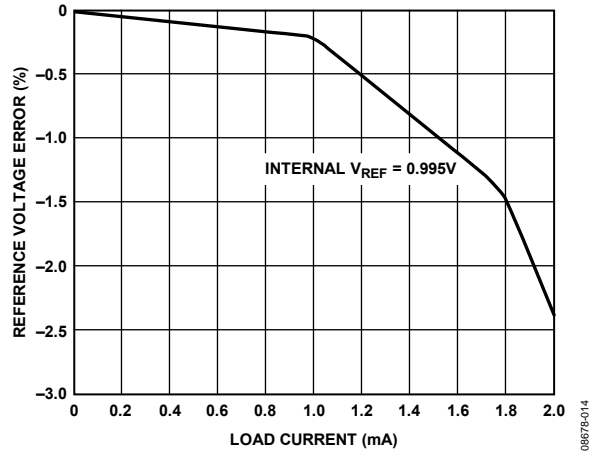

Figure 43. V_{REF} Accuracy vs. Load Current

External Reference Operation

The use of an external reference may be necessary to enhance the gain accuracy of the ADC or improve thermal drift characteristics. Figure 44 shows the typical drift characteristics of the internal reference in 1.0 V mode.

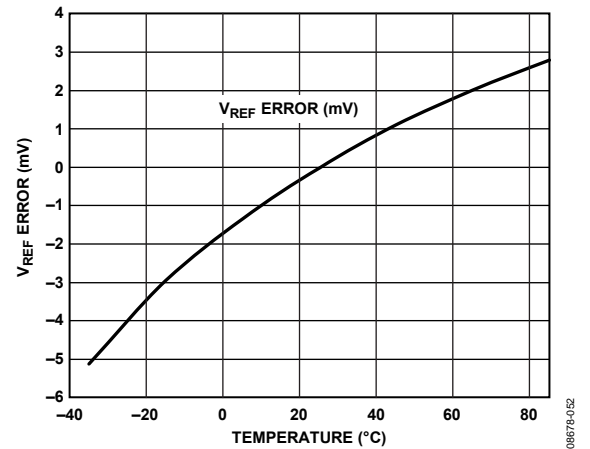

Figure 44. Typical V_{REF} Drift

When the SENSE pin is tied to AVDD, the internal reference is disabled, allowing the use of an external reference. An internal reference buffer loads the external reference with an equivalent 7.5 kΩ load (see Figure 28). The internal buffer generates the positive and negative full-scale references for the ADC core. Therefore, the external reference must be limited to a maximum of 1.0 V.

Table 10. Reference Configuration Summary

Selected Mode	SENSE Voltage (V)	Resulting VREF (V)	Resulting Differential Span (V p-p)
Fixed Internal Reference	AGND to 0.2	1.0 internal	2.0
Fixed External Reference	AVDD	1.0 applied to external VREF pin	2.0

CLOCK INPUT CONSIDERATIONS

For optimum performance, clock the AD9266 sample clock inputs, CLK+ and CLK-, with a differential signal. The signal is typically ac-coupled into the CLK+ and CLK- pins via a transformer or capacitors. These pins are biased internally (see Figure 45) and require no external bias.

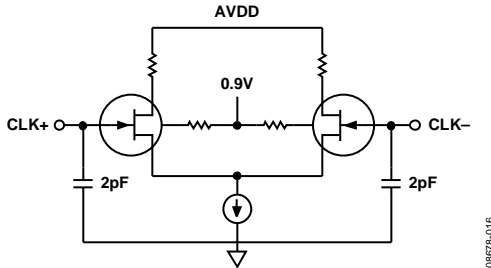

Figure 45. Equivalent Clock Input Circuit

Clock Input Options

The AD9266 has a very flexible clock input structure. The clock input can be a CMOS, LVDS, LVPECL, or sine wave signal. Regardless of the type of signal being used, clock source jitter is of great concern, as described in the Jitter Considerations section.

Figure 46 and Figure 47 show two preferred methods for clocking the AD9266 (at clock rates up to 625 MHz when using the internal clock divider). A low jitter clock source is converted from a single-ended signal to a differential signal using either an RF transformer or an RF balun.

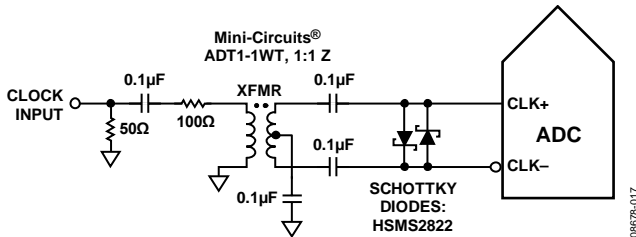

Figure 46. Transformer-Coupled Differential Clock (Up to 200 MHz)

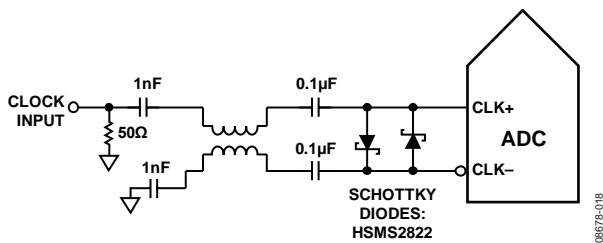

Figure 47. Balun-Coupled Differential Clock (Up to 625 MHz)

The RF balun configuration is recommended for clock frequencies between 125 MHz and 625 MHz, and the RF transformer is recommended for clock frequencies from 10 MHz to 200 MHz.

The back-to-back Schottky diodes across the transformer/balun secondary limit clock excursions into the AD9266 to approximately 0.8 V p-p differential.

This limit helps prevent the large voltage swings of the clock from feeding through to other portions of the AD9266 while preserving the fast rise and fall times of the signal that are critical to a low jitter performance.

If a low jitter clock source is not available, another option is to ac couple a differential PECL signal to the sample clock input pins, as shown in Figure 48. The AD9510/AD9511/AD9512/AD9513/AD9514/AD9515/AD9516-0/AD9516-1/AD9516-2/AD9516-3/AD9516-4/AD9516-5/AD9517-0/AD9517-1/AD9517-2/AD9517-3/AD9517-4 clock drivers offer excellent jitter performance.

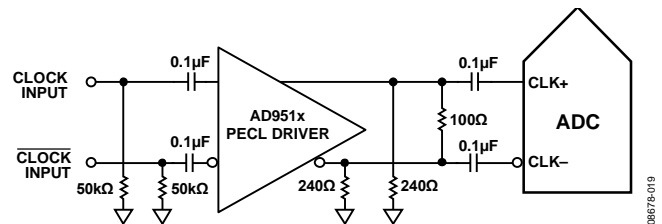

Figure 48. Differential PECL Sample Clock (Up to 625 MHz)

A third option is to ac couple a differential LVDS signal to the sample clock input pins, as shown in Figure 49. The AD9510/AD9511/AD9512/AD9513/AD9514/AD9515/AD9516-0/AD9516-1/AD9516-2/AD9516-3/AD9516-4/AD9516-5/AD9517-0/AD9517-1/AD9517-2/AD9517-3/AD9517-4 clock drivers offer excellent jitter performance.

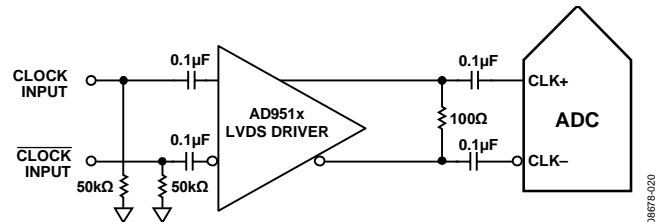

Figure 49. Differential LVDS Sample Clock (Up to 625 MHz)

In some applications, it may be acceptable to drive the sample clock inputs with a single-ended 1.8 V CMOS signal. In such applications, drive the CLK+ pin directly from a CMOS gate, and bypass the CLK- pin to ground with a 0.1 µF capacitor (see Figure 50).

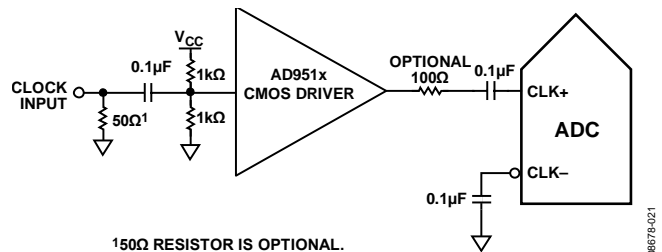

Figure 50. Single-Ended 1.8 V CMOS Input Clock (Up to 200 MHz)

Input Clock Divider

The AD9266 contains an input clock divider with the ability to divide the input clock by integer values between 1 and 8. Optimum performance can be obtained by enabling the internal duty cycle stabilizer (DCS) when using divide ratios other than 1, 2, or 4.

Clock Duty Cycle

Typical high speed ADCs use both clock edges to generate a variety of internal timing signals and, as a result, may be sensitive to clock duty cycle. Commonly, a $\pm 5\%$ tolerance is required on the clock duty cycle to maintain dynamic performance characteristics.

The AD9266 contains a duty cycle stabilizer (DCS) that retimes the nonsampling (falling) edge, providing an internal clock signal with a nominal 50% duty cycle. This allows the user to provide a wide range of clock input duty cycles without affecting the performance of the AD9266. Noise and distortion performance are nearly flat for a wide range of duty cycles with the DCS on, as shown in Figure 51.

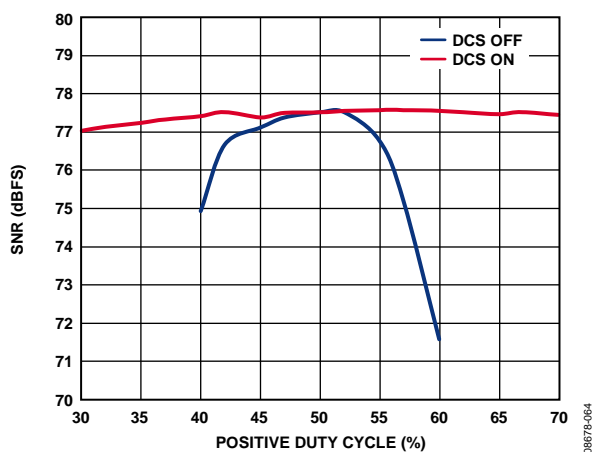

Figure 51. SNR vs. DCS On/Off

Jitter in the rising edge of the input is still of concern and is not easily reduced by the internal stabilization circuit. The duty cycle control loop does not function for clock rates less than 20 MHz nominally. The loop has a time constant associated with it that must be considered in applications in which the clock rate can change dynamically. A wait time of 1.5 μs to 5 μs is required after a dynamic clock frequency increase or decrease before the DCS loop is relocked to the input signal.

Jitter Considerations

High speed, high resolution ADCs are sensitive to the quality of the clock input. The degradation in SNR from the low frequency SNR (SNR_{LF}) at a given input frequency (f_{INPUT}) due to jitter (t_{JMS}) can be calculated by

$$\text{SNR}_{HF} = -10 \log[(2\pi \times f_{\text{INPUT}} \times t_{\text{JMS}})^2 + 10^{(-\text{SNR}_{LF}/10)}]$$

In the previous equation, the rms aperture jitter represents the clock input jitter specification. IF undersampling applications are particularly sensitive to jitter, as illustrated in Figure 52.

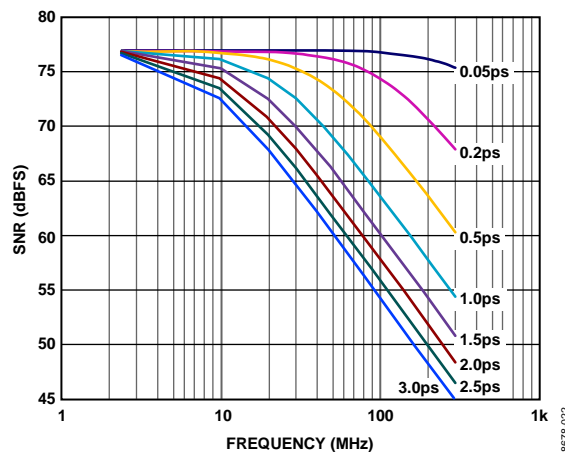

Figure 52. SNR vs. Input Frequency and Jitter

Treat the clock input as an analog signal when aperture jitter may affect the dynamic range of the AD9266. To avoid modulating the clock signal with digital noise, keep power supplies for clock drivers separate from the ADC output driver supplies. Low jitter, crystal-controlled oscillators make the best clock sources. If the clock is generated from another type of source (by gating, dividing, or another method), it should be retimed by the original clock at the last step.

For more information, see the [AN-501 Application Note](#) and the [AN-756 Application Note](#).

POWER DISSIPATION AND STANDBY MODE

As shown in Figure 53, the analog core power dissipated by the AD9266 is proportional to its sample rate. The digital power dissipation of the CMOS outputs are determined primarily by the strength of the digital drivers and the load on each output bit.

The maximum DRVDD current (I_{DRVDD}) can be calculated as

$$I_{DRVDD} = V_{DRVDD} \times C_{LOAD} \times f_{CLK} \times N$$

where N is the number of output bits (nine, in the case of the AD9266).

This maximum current occurs when every output bit switches on every clock cycle, that is, a full-scale square wave at the Nyquist frequency of $f_{CLK}/2$. In practice, the DRVDD current is established by the average number of output bits switching, which is determined by the sample rate and the characteristics of the analog input signal.

Reducing the capacitive load presented to the output drivers can minimize digital power consumption. The data in Figure 53 was taken using the same operating conditions as those used for the Typical Performance Characteristics, with a 5 pF load on each output driver.

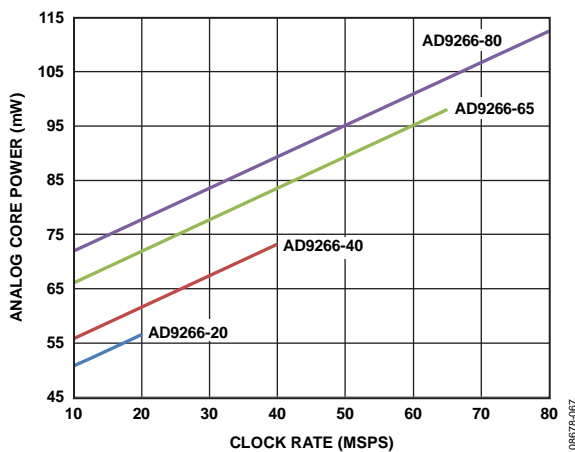

Figure 53. Analog Core Power vs. Clock Rate

In SPI mode, the AD9266 can be placed in power-down mode directly via the SPI port, or by using the programmable external MODE pin. In non-SPI mode, power-down is achieved by asserting the PDWN pin high. In this state, the ADC typically dissipates 500 μ W. During power-down, the output drivers are placed in a high impedance state. Asserting PDWN low (or the MODE pin in SPI mode) returns the AD9266 to its normal operating mode. Note that PDWN is referenced to the digital output driver supply (DRVDD) and should not exceed that supply voltage.

Low power dissipation in power-down mode is achieved by shutting down the reference, reference buffer, biasing networks, and clock. Internal capacitors are discharged when entering power-

down mode and then must be recharged when returning to normal operation. As a result, wake-up time is related to the time spent in power-down mode, and shorter power-down cycles result in proportionally shorter wake-up times.

When using the SPI port interface, the user can place the ADC in power-down mode or standby mode. Standby mode allows the user to keep the internal reference circuitry powered when faster wake-up times are required. See the Memory Map section for more details.

DIGITAL OUTPUTS

The AD9266 output drivers can be configured to interface with 1.8 V to 3.3 V CMOS logic families. Output data can also be multiplexed onto a single output bus to reduce the total number of traces required.

The CMOS output drivers are sized to provide sufficient output current to drive a wide variety of logic families. However, large drive currents tend to cause current glitches on the supplies and may affect converter performance.

Applications requiring the ADC to drive large capacitive loads or large fanouts may require external buffers or latches.

The output data format can be selected to be either offset binary or twos complement by setting the SCLK/DFS pin when operating in the external pin mode (see Table 11).

As detailed in the AN-877 Application Note, *Interfacing to High Speed ADCs via SPI*, the data format can be selected for offset binary, twos complement, or gray code when using the SPI control.

Table 11. SCLK/DFS and SDIO/PDWN Mode Selection (External Pin Mode)

Voltage at Pin	SCLK/DFS	SDIO/PDWN
AGND	Offset binary (default)	Normal operation (default)
DRVDD	Twos complement	Outputs disabled

Digital Output Enable Function (OEB)

When using the SPI interface, the data outputs and DCO can be independently three-stated by using the programmable external MODE pin. The MODE pin (OEB) function is enabled via Bits[6:5] of Register 0x08.

If the MODE pin is configured to operate in traditional OEB mode and the MODE pin is low, the output data drivers and DCOs are enabled. If the MODE pin is high, the output data drivers and DCOs are placed in a high impedance state. This OEB function is not intended for rapid access to the data bus. Note that the MODE pin is referenced to the digital output driver supply (DRVDD) and should not exceed that supply voltage.

TIMING

The AD9266 provides latched data with a pipeline delay of eight clock cycles. Data outputs are available one propagation delay (t_{PD}) after the rising edge of the clock signal.

Minimize the length of the output data lines and loads placed on them to reduce transients within the AD9266. These transients can degrade converter dynamic performance.

The lowest typical conversion rate of the AD9266 is 3 MSPS. At clock rates below 3 MSPS, dynamic performance may degrade.

Data Clock Output (DCO)

The AD9266 provides a DCO signal that is intended for capturing the data in an external register. The CMOS data outputs are valid on the rising and falling edge of DCO. See Figure 2 for a graphical timing description.

Table 12. Output Data Format

Input (V)	Condition (V)	Offset Binary Output Mode	Twos Complement Mode	OR
VIN+ – VIN–	< –VREF – 0.5 LSB	0000 0000 0000 0000	1000 0000 0000 0000	1
VIN+ – VIN–	= –VREF	0000 0000 0000 0000	1000 0000 0000 0000	0
VIN+ – VIN–	= 0	1000 0000 0000 0000	0000 0000 0000 0000	0
VIN+ – VIN–	= +VREF – 1.0 LSB	1111 1111 1111 1111	0111 1111 1111 1111	0
VIN+ – VIN–	> +VREF – 0.5 LSB	1111 1111 1111 1111	0111 1111 1111 1111	1

OUTPUT TEST

The [AD9266](#) includes various output test options to place predictable values on the outputs of the [AD9266](#).

OUTPUT TEST MODES

The output test options are described in Table 16 at Address 0x0D. When an output test mode is enabled, the analog section of the ADC is disconnected from the digital back end blocks and the test pattern is run through the output formatting block. Some of

the test patterns are subject to output formatting, and some are not. The PN generators from the PN sequence tests can be reset by setting Bit 4 or Bit 5 of Register 0x0D. These tests can be performed with or without an analog signal (if present, the analog signal is ignored), but they do require an encode clock. For more information, see the [AN-877 Application Note, Interfacing to High Speed ADCs via SPI](#).

SERIAL PORT INTERFACE (SPI)

The AD9266 serial port interface (SPI) allows the user to configure the converter for specific functions or operations through a structured register space provided inside the ADC. The SPI gives the user added flexibility and customization, depending on the application. Addresses are accessed via the serial port and can be written to or read from via the port. Memory is organized into bytes that can be further divided into fields, which are documented in the Memory Map section. For more detailed operational information, see the [AN-877 Application Note, Interfacing to High Speed ADCs via SPI](#).

CONFIGURATION USING THE SPI

Three pins define the SPI of this ADC: SCLK, SDIO, and CSB (see Table 13). The SCLK (a serial clock) is used to synchronize the read and write data presented from and to the ADC. SDIO (serial data input/output) is a dual-purpose pin that allows data to be sent and read from the internal ADC memory map registers. The CSB (chip select bar) is an active-low control that enables or disables the read and write cycles.

Table 13. Serial Port Interface Pins

Pin	Function
SCLK	Serial clock. The serial shift clock input, which is used to synchronize serial interface reads and writes.
SDIO	Serial data input/output. A dual-purpose pin that typically serves as an input or an output, depending on the instruction being sent and the relative position in the timing frame.
CSB	Chip select bar. An active-low control that gates the read and write cycles.

The falling edge of CSB, in conjunction with the rising edge of SCLK, determines the start of the framing. An example of the serial timing and its definitions can be found in Figure 54 and Table 5.

Other modes involving the CSB pin are available. CSB can be held low indefinitely, which permanently enables the device; this is called streaming. CSB can stall high between bytes to allow for additional external timing. When CSB is tied high, SPI functions are placed in high impedance mode. This mode turns on any SPI pin secondary functions.

During an instruction phase, a 16-bit instruction is transmitted. Data follows the instruction phase, and its length is determined by the W0 and W1 bits, as shown in Figure 54.

All data is composed of 8-bit words. The first bit of the first byte in a multibyte serial data transfer frame indicates whether a read command or a write command is issued. This allows the serial data input/output (SDIO) pin to change direction from an input to an output at the appropriate point in the serial frame.

In addition to word length, the instruction phase determines whether the serial frame is a read or write operation, allowing the serial port to be used both to program the chip and to read the contents of the on-chip memory. If the instruction is a readback operation, performing a readback causes the serial data input/output (SDIO) pin to change direction from an input to an output at the appropriate point in the serial frame.

Data can be sent in MSB-first mode or in LSB-first mode. MSB first is the default on power-up and can be changed via the SPI port configuration register. For more information about this and other features, see the [AN-877 Application Note, Interfacing to High Speed ADCs via SPI](#).

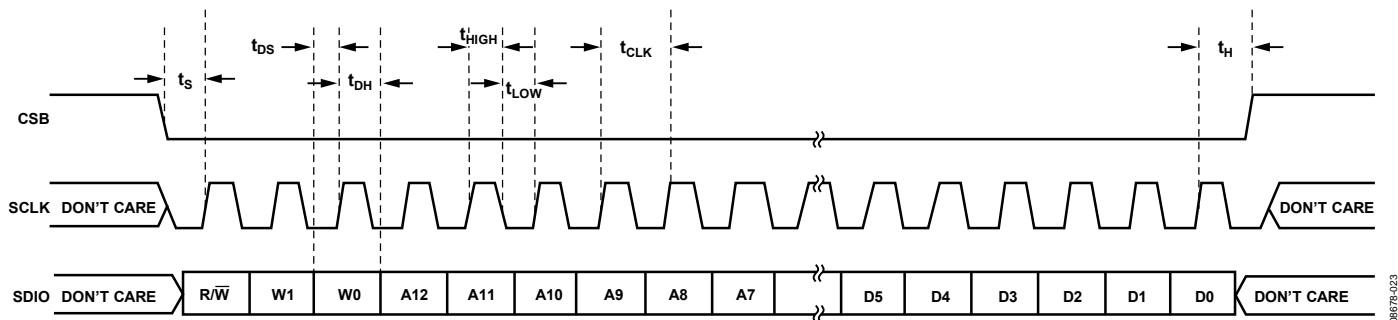

Figure 54. Serial Port Interface Timing Diagram

08678-023

HARDWARE INTERFACE

The pins described in Table 13 constitute the physical interface between the programming device of the user and the serial port of the AD9266. The SCLK pin and the CSB pin function as inputs when using the SPI interface. The SDIO pin is bidirectional, functioning as an input during write phases and as an output during readback.

The SPI interface is flexible enough to be controlled by either FPGAs or microcontrollers. One method for SPI configuration is described in detail in the [AN-812 Application Note, Microcontroller-Based Serial Port Interface \(SPI\) Boot Circuit](#).

The SPI port should not be active during periods when the full dynamic performance of the converter is required. Because the SCLK signal, the CSB signal, and the SDIO signal are typically asynchronous to the ADC clock, noise from these signals can degrade converter performance. If the on-board SPI bus is used for other devices, it may be necessary to provide buffers between this bus and the AD9266 to prevent these signals from transitioning at the converter inputs during critical sampling periods.

SDIO/PDWN and SCLK/DFS serve a dual function when the SPI interface is not being used. When the pins are strapped to DRVDD or ground during device power-on, they are associated with a specific function. The Digital Outputs section describes the strappable functions supported on the AD9266.

CONFIGURATION WITHOUT THE SPI

In applications that do not interface to the SPI control registers, the SDIO/PDWN pin and the SCLK/DFS pin serve as standalone CMOS-compatible control pins. When the device is powered up, it is assumed that the user intends to use the pins as static control lines for the power-down and output data format feature control. In

this mode, connect the CSB chip select to DRVDD, which disables the serial port interface.

Table 14. Mode Selection

Pin	External Voltage	Configuration
SDIO/PDWN	DRVDD AGND (default)	Chip power-down mode Normal operation (default)
SCLK/DFS	DRVDD AGND (default)	Twos complement enabled Offset binary enabled

SPI ACCESSIBLE FEATURES

Table 15 provides a brief description of the general features that are accessible via the SPI. These features are described in detail in the [AN-877 Application Note, Interfacing to High Speed ADCs via SPI](#). The AD9266 part-specific features are described in detail in Table 16.

Table 15. Features Accessible Using the SPI

Feature	Description
Modes	Allows the user to set either power-down mode or standby mode
Clock Offset	Allows the user to access the DCS via the SPI
Test I/O	Allows the user to digitally adjust the converter offset
Output Mode	Allows the user to set test modes to have known data on output bits
Output Phase	Allows the user to set up outputs
Output Delay	Allows the user to set the output clock polarity
	Allows the user to vary the DCO delay

MEMORY MAP

READING THE MEMORY MAP REGISTER TABLE

Each row in the memory map register table (see Table 16) contains eight bit locations. The memory map is roughly divided into four sections: the chip configuration registers (Address 0x00 to Address 0x02); the device index and transfer register (Address 0xFF); the program registers, including setup, control, and test (Address 0x08 to Address 0x2A); and the AD9266-specific customer SPI control register (Address 0x101).

Table 16 documents the default hexadecimal value for each hexadecimal address shown. The column with the heading Bit 7 (MSB) is the start of the default hexadecimal value given. For example, Address 0x2A, the OR/MODE select register, has a hexadecimal default value of 0x01. This means that in Address 0x2A, Bits[7:1] = 0, and Bit 0 = 1. This setting is the default OR/MODE setting. The default value results in the programmable external MODE/OR pin (Pin 23) functioning as an out-of-range digital output. For more information on this function and others, see the [AN-877 Application Note, Interfacing to High Speed ADCs via SPI](#). This application note details the functions controlled by Register 0x00 to Register 0xFF. The remaining register, Register 0x101, is documented in the Memory Map Register Descriptions section that follows Table 16.

OPEN LOCATIONS

All address and bit locations that are not included in the SPI map are not currently supported for this device. Unused bits of a valid address location should be written with 0s. Writing to these locations is required only when part of an address location is open (for example, Address 0x2A). If the entire address location is open, it is omitted from the SPI map (for example, Address 0x13) and should not be written.

DEFAULT VALUES

After the AD9266 is reset, critical registers are loaded with default values. The default values for the registers are given in the memory map register table (see Table 16).

Logic Levels

An explanation of logic level terminology follows:

- “Bit is set” is synonymous with “bit is set to Logic 1” or “writing Logic 1 for the bit.”
- “Clear a bit” is synonymous with “bit is set to Logic 0” or “writing Logic 0 for the bit.”

Transfer Register Map

Address 0x08 to Address 0x18 are shadowed. Writes to these addresses do not affect part operation until a transfer command is issued by writing 0x01 to Address 0xFF, setting the transfer bit. This allows these registers to be updated internally and simultaneously when the transfer bit is set. The internal update takes place when the transfer bit is set, and then the bit autoclears.

MEMORY MAP REGISTER TABLE

All address and bit locations that are not included in Table 16 are not currently supported for this device.

Table 16.

Addr (Hex)	Register Name	Bit 7 (MSB)	Bit 6	Bit 5	Bit 4	Bit 3	Bit 2	Bit 1	Bit 0 (LSB)	Default Value (Hex)	Comments
Chip Configuration Registers											
0x00	SPI port configuration	0	LSB first	Soft reset	1	1	Soft reset	LSB first	0	0x18	The nibbles are mirrored so that LSB- or MSB-first mode registers correctly, regardless of shift mode.
0x01	Chip ID	8-bit chip ID, Bits[7:0] AD9266 = 0x78								Read only	Unique chip ID used to differentiate devices; read only.
0x02	Chip grade	Open	Speed grade ID, Bits[6:4] (identify device variants of chip ID) 20 MSPS = 000 40 MSPS = 001 65 MSPS = 010 80 MSPS = 011			Open			Read only	Unique speed grade ID used to differentiate devices; read only.	
Device Index and Transfer Register											
0xFF	Transfer	Open							Transfer	0x00	Synchronously transfers data from the master shift register to the slave.
Program Registers											
0x08	Modes	External Pin 23 mode input enable	External Pin 23 function when high 00 = full power-down 01 = standby 10 = normal mode: output disabled 11 = normal mode: output enabled			Open		00 = chip run 01 = full power-down 10 = standby 11 = chip wide digital reset		0x00	Determines various generic modes of chip operation.
0x09	Clock	Open							Duty cycle stabilize	0x01	Enable internal duty cycle stabilizer (DCS).
0x0B	Clock divide	Open					Clock divider, Bits[2:0] Clock divide ratio: 000 = divide by 1 001 = divide by 2 010 = divide by 3 011 = divide by 4 100 = divide by 5 101 = divide by 6 110 = divide by 7 111 = divide by 8			0x00	The divide ratio is the value plus 1.
0x0D	Test mode	User test mode 00 = single 01 = alternate 10 = single once 11 = alternate once	Reset PN long gen	Reset PN short gen	Output test mode, Bits[3:0] (local) 0000 = off (default) 0001 = midscale short 0010 = positive FS 0011 = negative FS 0100 = alternating checkerboard 0101 = PN 23 sequence 0110 = PN 9 sequence 0111 = 1/0 word toggle 1000 = user input 1001 = 1/0 bit toggle 1010 = 1× sync 1011 = one bit high 1100 = mixed bit frequency					0x00	When set, the test data is placed on the output pins in place of normal data.
0x10	Offset adjust	8-bit device offset adjustment, Bits[7:0] (local) Offset adjust in LSBs from +127 to -128 (twos complement format)								0x00	Device offset trim.
0x14	Output mode	00 = 3.3 V CMOS 10 = 1.8 V CMOS	Open	Output disable	Open	Output invert	00 = offset binary 01 = twos complement 10 = gray code 11 = offset binary			0x00	Configures the outputs and the format of the data.

Addr (Hex)	Register Name	Bit 7 (MSB)	Bit 6	Bit 5	Bit 4	Bit 3	Bit 2	Bit 1	Bit 0 (LSB)	Default Value (Hex)	Comments
0x15	Output adjust	3.3 V DCO drive strength 00 = 1 stripe (default) 01 = 2 stripes 10 = 3 stripes 11 = 4 stripes		1.8 V DCO drive strength 00 = 1 stripe 01 = 2 stripes 10 = 3 stripes (default) 11 = 4 stripes		3.3 V data drive strength 00 = 1 stripe (default) 01 = 2 stripes 10 = 3 stripes 11 = 4 stripes		1.8 V data drive strength 00 = 1 stripe 01 = 2 stripes 10 = 3 stripes (default) 11 = 4 stripes		0x22	Determines CMOS output drive strength properties.
0x16	Output phase	DCO output polarity 0 = normal 1 = inverted	Open				Input clock phase adjust, Bits[2:0] (Value is number of input clock cycles of phase delay) 000 = no delay 001 = 1 input clock cycle 010 = 2 input clock cycles 011 = 3 input clock cycles 100 = 4 input clock cycles 101 = 5 input clock cycles 110 = 6 input clock cycles 111 = 7 input clock cycles			0x00	On devices that use global clock divide, determines which phase of the divider output is used to supply the output clock; internal latching is unaffected.
0x17	Output delay	Enable DCO delay	Open	Enable data delay	Open		DCO/data delay[2:0] (typical values) 000 = 0.56 ns 001 = 1.12 ns 010 = 1.68 ns 011 = 2.24 ns 100 = 2.80 ns 101 = 3.36 ns 110 = 3.92 ns 111 = 4.48 ns			0x00	Sets the fine output delay of the output clock but does not change internal timing. (Typical values)
0x19	USER_PATT1_LSB	B7	B6	B5	B4	B3	B2	B1	B0	0x00	User-defined pattern, 1 LSB.
0x1A	USER_PATT1_MSB	B15	B14	B13	B12	B11	B10	B9	B8	0x00	User-defined pattern, 1 MSB.
0x1B	USER_PATT2_LSB	B7	B6	B5	B4	B3	B2	B1	B0	0x00	User-defined pattern, 2 LSB.
0x1C	USER_PATT2_MSB	B15	B14	B13	B12	B11	B10	B9	B8	0x00	User-defined pattern, 2 MSB.
0x2A	OR/MODE select	Open							0 = MODE 1 = OR (default)	0x01	Selects I/O functionality in conjunction with Address 0x08 for MODE (input) or OR (output) on External Pin 23.
AD9266-Specific Customer SPI Control Register											
0x10 1	USR2	Open				Enable GCLK detect	Run GCLK	Open	Disable SDIO pull-down	0x08	Enables internal oscillator for clock rates of <5 MHz.

MEMORY MAP REGISTER DESCRIPTIONS

For additional information about functions that are controlled in Register 0x00 to Register 0xFF, see the [AN-877 Application Note](#), *Interfacing to High Speed ADCs via SPI*.

USR2 (Register 0x101)**Bit 3—Enable GCLK Detect**

Normally set high, this bit enables a circuit that detects encode rates below about 5 MSPS. When a low encode rate is detected, an internal oscillator, GCLK, is enabled, ensuring the proper operation of several circuits. If set low, the detector is disabled.

Bit 2—Run GCLK

This bit enables the GCLK oscillator. For some applications with encode rates below 10 MSPS, it may be preferable to set this bit high to supersede the GCLK detector.

Bit 0—Disable SDIO Pull-Down

This bit can be set high to disable the internal 30 k Ω pull-down on the SDIO pin, which can be used to limit the loading when many devices are connected to the SPI bus.

APPLICATIONS INFORMATION

DESIGN GUIDELINES

Before starting design and layout of the [AD9266](#) as a system, it is recommended that the designer become familiar with these guidelines, which discuss the special circuit connections and layout requirements needed for certain pins.

Power and Ground Recommendations

When connecting power to the [AD9266](#), it is strongly recommended that two separate supplies be used. Use one 1.8 V supply for analog (AVDD); use a separate 1.8 V to 3.3 V supply for the digital output supply (DRVDD). If a common 1.8 V AVDD and DRVDD supply must be used, the AVDD and DRVDD domains must be isolated with a ferrite bead or filter choke and separate decoupling capacitors. Several different decoupling capacitors can be used to cover both high and low frequencies. Locate these capacitors close to the point of entry at the PCB level and close to the pins of the part, with minimal trace length.

A single PCB ground plane should be sufficient when using the [AD9266](#). With proper decoupling and smart partitioning of the PCB analog, digital, and clock sections, optimum performance is easily achieved.

Exposed Paddle Thermal Heat Sink Recommendations

The exposed paddle (Pin 0) is the only ground connection for the [AD9266](#); therefore, it must be connected to analog ground (AGND) on the PCB. To achieve the best electrical and thermal performance, mate an exposed (no solder mask) continuous copper plane on the PCB to the [AD9266](#) exposed paddle, Pin 0.

The copper plane should have several vias to achieve the lowest possible resistive thermal path for heat dissipation to flow through the bottom of the PCB. Fill or plug these vias with nonconductive epoxy.

To maximize the coverage and adhesion between the ADC and the PCB, overlay a silkscreen to partition the continuous plane on the PCB into several uniform sections. This provides several tie points between the ADC and the PCB during the reflow process. Using one continuous plane with no partitions guarantees only one tie point between the ADC and the PCB. For detailed information about packaging and PCB layout of chip scale packages, see the [AN-772 Application Note, A Design and Manufacturing Guide for the Lead Frame Chip Scale Package \(LFCSP\)](#).

Encode Clock

For optimum dynamic performance, use a low jitter encode clock source with a 50% duty cycle \pm 5% to clock the [AD9266](#).

VCM

The VCM pin should be decoupled to ground with a 0.1 μ F capacitor, as shown in Figure 38.

RBIAS

The [AD9266](#) requires that a 10 k Ω resistor be placed between the RBIAS pin and ground. This resistor sets the master current reference of the ADC core and should have at least a 1% tolerance.

Reference Decoupling

Externally decouple the VREF pin to ground with a low ESR, 1.0 μ F capacitor in parallel with a low ESR, 0.1 μ F ceramic capacitor.

SPI Port

The SPI port should not be active during periods when the full dynamic performance of the converter is required. Because the SCLK, CSB, and SDIO signals are typically asynchronous to the ADC clock, noise from these signals can degrade converter performance. If the on-board SPI bus is used for other devices, it may be necessary to provide buffers between this bus and the [AD9266](#) to keep these signals from transitioning at the converter inputs during critical sampling periods.

OUTLINE DIMENSIONS

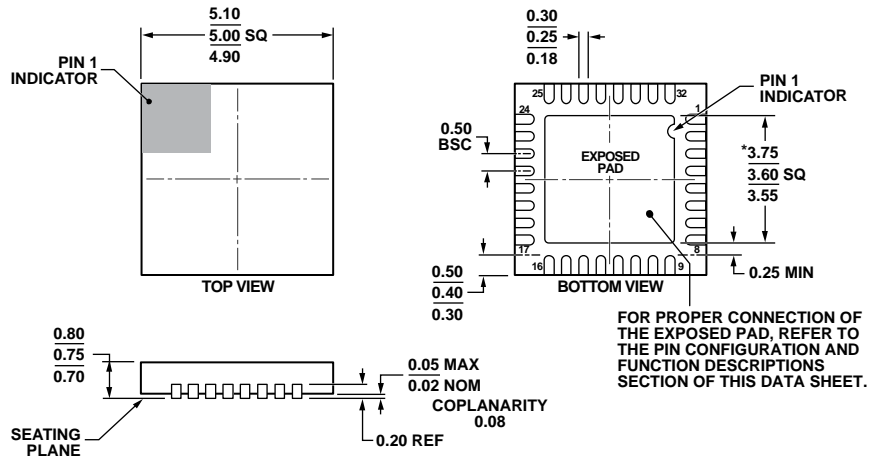

*COMPLIANT TO JEDEC STANDARDS MO-220-WHHD-5 WITH EXCEPTION TO EXPOSED PAD DIMENSION.

Figure 55. 32-Lead Lead Frame Chip Scale Package [LFCSP_WQ]
5 mm × 5 mm Body, Very Very Thin Quad (CP-32-12)
Dimensions shown in millimeters

08-16-2010-B

ORDERING GUIDE

Model ¹	Temperature Range	Package Description	Package Option
AD9266BCPZ-80	-40°C to +85°C	32-Lead Lead Frame Chip Scale Package [LFCSP_WQ]	CP-32-12
AD9266BCPZRL7-80	-40°C to +85°C	32-Lead Lead Frame Chip Scale Package [LFCSP_WQ]	CP-32-12
AD9266BCPZ-65	-40°C to +85°C	32-Lead Lead Frame Chip Scale Package [LFCSP_WQ]	CP-32-12
AD9266BCPZRL7-65	-40°C to +85°C	32-Lead Lead Frame Chip Scale Package [LFCSP_WQ]	CP-32-12
AD9266BCPZ-40	-40°C to +85°C	32-Lead Lead Frame Chip Scale Package [LFCSP_WQ]	CP-32-12
AD9266BCPZRL7-40	-40°C to +85°C	32-Lead Lead Frame Chip Scale Package [LFCSP_WQ]	CP-32-12
AD9266BCPZ-20	-40°C to +85°C	32-Lead Lead Frame Chip Scale Package [LFCSP_WQ]	CP-32-12
AD9266BCPZRL7-20	-40°C to +85°C	32-Lead Lead Frame Chip Scale Package [LFCSP_WQ]	CP-32-12
AD9266-80EBZ		Evaluation Board	
AD9266-65EBZ		Evaluation Board	
AD9266-40EBZ		Evaluation Board	
AD9266-20EBZ		Evaluation Board	

¹ Z = RoHS Compliant Part.

X-ON Electronics

Largest Supplier of Electrical and Electronic Components

Click to view similar products for [Data Conversion IC Development Tools](#) category:

Click to view products by [Analog Devices](#) manufacturer:

Other Similar products are found below :

[EVAL-AD5063EBZ](#) [EVAL-AD5422LFEBZ](#) [EVAL-AD7265EDZ](#) [EVAL-AD7641EDZ](#) [EVAL-AD7674EDZ](#) [EVAL-AD7719EBZ](#) [EVAL-AD7767-1EDZ](#) [EVAL-AD7995EBZ](#) [AD9114-DPG2-EBZ](#) [AD9211-200EBZ](#) [AD9251-20EBZ](#) [AD9251-65EBZ](#) [AD9255-125EBZ](#) [AD9284-250EBZ](#) [AD9613-170EBZ](#) [AD9627-125EBZ](#) [AD9629-20EBZ](#) [AD9709-EBZ](#) [AD9716-DPG2-EBZ](#) [AD9737A-EBZ](#) [AD9787-DPG2-EBZ](#) [AD9993-EBZ](#) [DAC8555EVM](#) [ADS5482EVM](#) [ADS8372EVM](#) [EVAL-AD5061EBZ](#) [EVAL-AD5062EBZ](#) [EVAL-AD5443-DBRDZ](#) [EVAL-AD5570SDZ](#) [EVAL-AD7450ASDZ](#) [EVAL-AD7677EDZ](#) [EVAL-AD7992EBZ](#) [EVAL-AD7994EBZ](#) [AD9119-MIX-EBZ](#) [AD9148-M5375-EBZ](#) [AD9204-80EBZ](#) [AD9233-125EBZ](#) [AD9265-105EBZ](#) [AD9265-80EBZ](#) [AD9608-125EBZ](#) [AD9629-80EBZ](#) [AD9648-125EBZ](#) [AD9649-20EBZ](#) [AD9650-80EBZ](#) [AD9765-EBZ](#) [AD9767-EBZ](#) [AD9778A-DPG2-EBZ](#) [ADS8322EVM](#) [LM96080EB/NOPB](#) [EVAL-AD5445SDZ](#)