

FEATURES

- 1.65 GHz differential clock inputs/outputs
- 10-bit programmable dividers, 1 to 1024, all integers
- Up to 4 differential outputs or 8 CMOS outputs
- Pin strapping capability for hardwired programming at power-up
- <115 fs rms broadband random jitter (see Figure 25)
- Additive output jitter: 41 fs rms typical (12 kHz to 20 MHz)
- Excellent output-to-output isolation
- Automatic synchronization of all outputs
- Single 2.5 V/3.3 V power supply
- Internal LDO (low drop-out) voltage regulator for enhanced power supply immunity
- Phase offset select for output-to-output coarse delay adjust
- 3 programmable output logic levels, LVDS, HSTL, and CMOS
- Serial control port (SPI/I²C) or pin-programmable mode
- Space-saving 24-lead LFCSP

APPLICATIONS

- Low jitter, low phase noise clock distribution
- Clocking high speed ADCs, DACs, DDSs, DDCs, DUCs, MxFEs
- High performance wireless transceivers
- High performance instrumentation
- Broadband infrastructure

GENERAL DESCRIPTION

The [AD9508](#) provides clock fanout capability in a design that emphasizes low jitter to maximize system performance. This device benefits applications like clocking data converters with demanding phase noise and low jitter requirements.

There are four independent differential clock outputs, each with various types of logic levels available. Available logic types include LVDS (1.65 GHz), HSTL (1.65 GHz), and 1.8 V CMOS (250 MHz). In 1.8 V CMOS output mode, the differential output becomes two CMOS single-ended signals. The CMOS outputs are 1.8 V logic levels, regardless of the operating supply voltage.

FUNCTIONAL BLOCK DIAGRAM

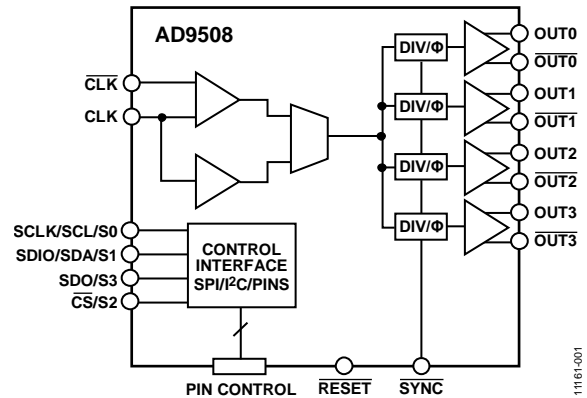

Figure 1.

Each output has a programmable divider that can be bypassed or be set to divide by any integer up to 1024. In addition, the [AD9508](#) supports a coarse output phase adjustment between the outputs.

The device can also be pin programmed for various fixed configurations at power-up without the need for SPI or I²C programming.

The [AD9508](#) is available in a 24-lead LFCSP and operates from a either a single 2.5 V or 3.3 V supply. The temperature range is -40°C to +85°C.

TABLE OF CONTENTS

Features	1	Clock Input.....	23
Applications.....	1	Clock Outputs.....	24
Functional Block Diagram	1	Clock Dividers	24
General Description	1	Phase Delay Control	24
Revision History	3	Reset Modes	25
Specifications.....	4	Power-Down Mode.....	25
Electrical Characteristics	4	Output Clock Synchronization.....	25
Power Supply Current and Temperature Conditions	4	Power Supply.....	25
Clock Inputs and Output DC Specifications	5	Thermally Enhanced Package Mounting Guidelines.....	25
Output Driver Timing Characteristics	6	Pin Strapping to Program on Power-Up	26
Logic Inputs.....	7	Serial Control Port	27
Serial Port Specifications—SPI Mode.....	7	SPI/I ² C Port Selection	27
Serial Port Specifications—I ² C Mode	8	SPI Serial Port Operation	27
External Resistor Values For Pin Strapping Mode.....	9	I ² C Serial Port Operation	30
Clock Output Additive Phase Noise	9	Register Map	33
Clock Output Additive Time Jitter.....	10	Register Map Bit Descriptions	34
Absolute Maximum Ratings.....	11	Serial Port Configuration (Register 0x00)	34
Thermal Characteristics	11	Silicon Revision (Register 0x0A to Register 0x0D)	34
ESD Caution.....	11	Chip Level Functions (Register 0x12 to Register 0x14)	34
Pin Configuration and Function Descriptions.....	12	OUT0 Functions (Register 0x15 to Register 0x1A).....	35
Typical Performance Characteristics	14	OUT1 Functions (Register 0x1B to Register 0x20)	36
Test Circuits.....	20	OUT2 Functions (Register 0x21 to Register 0x26).....	37
Input/Output Termination Recommendations.....	20	OUT3 Functions (Register 0x27 to Register 0x2C).....	38
Terminology	21	Packaging and Ordering Information	40
Theory of Operation	22	Outline Dimensions	40
Detailed Block Diagram	22	Ordering Guide	40
Programming Mode Selection.....	22		

REVISION HISTORY**6/2017—Rev. F to Rev. G**

Updated Outline Dimensions.....	40
Changes to Ordering Guide.....	40

4/2015—Rev. E to Rev. F

Changes to Clock Outputs Section	24
Changes to Table 28	35
Changes to Table 30	36
Changes to Table 32	38
Changes to Table 34	39

11/2014—Rev. D to Rev. E

Changes to Figure 1	1
Moved Revision History Section.....	3
Changes to Table 12	12
Changes to Clock Outputs Section, Clock Dividers Section, and Phase Delay Control Section	24
Changed Individual Clock Channel Power-Down Section to Individual Clock Divider Power-Down Section	25
Changes to Individual Clock Divider Power-Down Section and Output Clock Synchronization Section.....	25
Changes to Pin Strapping to Program on Power-up Section and Table 15	26
Changes to Table 27 and Table 28	35
Changes to Table 29 and Table 30	36
Changes to Table 31 and Table 32	37
Changes to Table 33	38
Changes to Table 34	39

9/2014—Rev. C to Rev. D

Changes to Table 1	3
Changes to Table 2	4
Changes to Figure 37 Caption; Added Figure 38; Renumbered Sequentially	19
Changes to Clock Input Section and Table 14.....	23

2/2014—Rev. B to Rev. C

Changes to Table 14	22
---------------------------	----

10/2013—Rev. A to Rev. B

Change to Figure 5 Caption.....	13
Change to Figure 13 Caption.....	14
Change to Figure 19 Caption.....	15
Change to Individual Clock Channel Power-Down Section	23
Change to Write Section	27
Changes to Table 27	34
Changes to Table 29	35
Changes to Table 31	36
Changes to Table 33	37

4/2013—Rev. 0 to Rev. A

Changes to Table 9	9
Changes to Figure 10	14
Changes to Figure 15	15
Changes to Figure 24 and Figure 26	16
Changes to Figure 27, Figure 29 to Figure 32.....	17
Changes to Figure 33	18

1/2013—Revision 0: Initial Version

SPECIFICATIONS

ELECTRICAL CHARACTERISTICS

Typical values are given for $V_S = 3.3\text{ V}$ and 2.5 V and $T_A = 25^\circ\text{C}$; minimum and maximum values are given over the full $V_{DD} = 3.3\text{ V} + 5\%$ down to $2.5\text{ V} - 5\%$ and $T_A = -40^\circ\text{C}$ to $+85^\circ\text{C}$ variation; and input slew rate $> 1\text{ V/ns}$, unless otherwise noted.

POWER SUPPLY CURRENT AND TEMPERATURE CONDITIONS

Table 1.

Parameter	Min	Typ	Max	Unit	Test Conditions/Comments
SUPPLY VOLTAGE	2.375	2.5	3.465	V	Use supply voltage setting (2.5 V or 3.3 V) and appropriate current consumption configuration (see Current Consumption parameters in Table 1) to calculate total power dissipation
CURRENT CONSUMPTION					
LVDS Configuration		165	182	mA	Input clock: 1500 MHz in differential mode, all LVDS output drivers at 1500 MHz
HSTL Configuration		122	134	mA	Input clock: 800 MHz in differential mode, all LVDS output drivers at 200 MHz
CMOS Configuration		194	213	mA	Input clock: 1500 MHz in differential mode, all HSTL output drivers at 1500 MHz
Full Power-Down		131	144	mA	Input clock: 491.52 MHz in differential mode, all output drivers at 491.52 MHz
Full Power-Down		92	101	mA	Input clock: 122.88 MHz in differential mode, all output drivers at 122.88 MHz
Full Power-Down		141	185	mA	Input clock: 1500 MHz in differential mode, all CMOS output drivers at 250 MHz, 10 pF load
Full Power-Down		122	134	mA	Input clock: 800 MHz in differential mode, all CMOS outputs drivers at 200 MHz, 10 pF load
Full Power-Down		85	94	mA	Input clock: 100 MHz in differential mode, all CMOS outputs drivers at 100 MHz, 10 pF load
TEMPERATURE					
Ambient Temperature Range, T_A	-40	+25	+85	$^\circ\text{C}$	Junction temperatures above 115°C can degrade performance but no damage should occur, unless the absolute temperature is exceeded
Junction Temperature, T_J			115	$^\circ\text{C}$	

CLOCK INPUTS AND OUTPUT DC SPECIFICATIONS

Table 2.

Parameter	Symbol	Min	Typ	Max	Unit	Test Conditions/Comments
CLOCK INPUTS						
Differential Mode						
Input Frequency		0		1650	MHz	Differential input
Input Sensitivity		360		2200	mV p-p	As measured with a differential probe; jitter performance improves with higher slew rates (greater voltage swing)
Input Common-Mode Voltage	V_{ICM}	0.95	1.05	1.15	V	Input pins are internally self biased, which enables ac coupling
Input Voltage Offset			30		mV	
DC-Coupled Input Common-Mode Range	V_{CMR}	0.58		1.67	V	This is the allowable common-mode voltage range when dc-coupled
Pulse Width						
Low		303			ps	
High		303			ps	
Input Resistance (Single-Ended)		5.0	7	9	k Ω	
Input Capacitance	C_{IN}		2		pF	
Input Bias Current (Each Pin)		100		400	μ A	Full input swing
CMOS CLOCK MODE (SINGLE-ENDED)						
Input Frequency				250	MHz	2.5 V or 3.3 V CMOS only; for 1.8 V CMOS, use (ac-coupled) differential input mode
Input Voltage						
High	V_{IH}	$V_{DD}/2 + 0.15$			V	
Low	V_{IL}			$V_{DD}/2 - 0.15$	V	
Input Current						
High	I_{INH}		1		μ A	
Low	I_{INL}		-142		μ A	
Input Capacitance	C_{IN}		2		pF	
LVDS CLOCK OUTPUTS						
Output Frequency				1650	MHz	Termination = 100 Ω differential (OUTx, \overline{OUTx})
Output Voltage Differential	V_{OD}	247	375	454	mV	$V_{OH} - V_{OL}$ measurement across a differential pair at the default amplitude setting with output driver not toggling; see Figure 6 for variation over frequency
Delta V_{OD}	ΔV_{OD}			50	mV	This is the absolute value of the difference between V_{OD} when the normal output is high vs. when the complementary output is high
Offset Voltage	V_{OS}	1.125	1.18	1.375	V	$(V_{OH} + V_{OL})/2$ across a differential pair
Delta V_{OS}	ΔV_{OS}			50	mV	This is the absolute value of the difference between V_{OS} when the normal output is high vs. when the complementary output is high
Short-Circuit Current	I_{SA}, I_{SB}		13.6	24	mA	Each pin (output shorted to GND)
LVDS Duty Cycle		45		55	%	Up to 750 MHz input
		39		61	%	750 MHz to 1500 MHz input
			50.1		%	1650 MHz input
HSTL CLOCK OUTPUTS						
Output Frequency				1650	MHz	100 Ω across differential pair; default amplitude setting
Differential Output Voltage	V_O	859	925	978	mV	$V_{OH} - V_{OL}$ with output driver static
Common-Mode Output Voltage	V_{OCM}	905	940	971	mV	$(V_{OH} + V_{OL})/2$ with output driver static
HSTL Duty Cycle		45		55	%	Up to 750 MHz input
		40		60	%	750 MHz to 1500 MHz input
			50.9		%	1650 MHz input

Parameter	Symbol	Min	Typ	Max	Unit	Test Conditions/Comments
CMOS CLOCK OUTPUTS						
Output Frequency				250	MHz	Single-ended; termination = open; OUTx and OUTx in phase With 10 pF load per output, see Figure 14 for swing vs. frequency
Output Voltage						
At 1 mA Load						
High	V _{OH}	1.7			V	
Low	V _{OL}			0.1	V	
At 10 mA load						
High	V _{OH}	1.2			V	
Low	V _{OL}			0.6	V	
At 10 mA Load (2 × CMOS Mode)						
High	V _{OH}	1.45			V	
Low	V _{OL}			0.35	V	
CMOS Duty Cycle		45		55	%	Up to 250 MHz

OUTPUT DRIVER TIMING CHARACTERISTICS

Table 3.

Parameter	Symbol	Min	Typ	Max	Unit	Test Conditions/Comments
LVDS OUTPUTS						
Output Rise/Fall Time	t _R , t _F		152	177	ps	Termination = 100 Ω differential, 1 × LVDS 20% to 80% measured differentially
Propagation Delay, Clock-to-LVDS Output	t _{PD}	1.56	2.01	2.43	ns	
Temperature Coefficient			2.8		ps/°C	
Output Skew ¹						
All LVDS Outputs						
On the Same Part				48	ps	
Across Multiple Parts				781	ps	Assumes same temperature and supply; takes into account worst-case propagation delay delta due to worst-case process variation
HSTL OUTPUTS						
Output Rise/Fall Time	t _R , t _F		118	143	ps	Termination = 100 Ω differential, 1 × HSTL 20% to 80% measured differentially
Propagation Delay, Clock-to-HSTL Output	t _{PD}	1.59	2.05	2.5	ns	
Temperature Coefficient			2.9		ps/°C	
Output Skew ¹						
All HSTL Outputs						
On the Same Part				59	ps	
Across Multiple Parts				825	ps	Assumes same temperature and supply; takes into account worst-case propagation delay delta due to worst-case process variation
CMOS OUTPUTS						
Output Rise/Fall Time	t _R , t _F		1.18	1.45	ns	20% to 80%; C _{LOAD} = 10 pF
Propagation Delay, Clock-to-CMOS Output	t _{PD}	2.04	2.56	3.07	ns	10 pF load
Temperature Coefficient			3.3		ps/°C	
Output Skew ¹						
All CMOS Outputs						
On the Same Part				112	ps	
Across Multiple Parts				965	ps	Assumes same temperature and supply; takes into account worst-case propagation delay delta due to worst-case process variation

Parameter	Symbol	Min	Typ	Max	Unit	Test Conditions/Comments
OUTPUT LOGIC SKEW ¹						CMOS load = 10 pF and LVDS load = 100 Ω
LVDS Output(s) and HSTL Output(s)			77	119	ps	Outputs on the same device; assumes worst-case output combination
LVDS Output(s) and CMOS Output(s)			497	700	ps	Outputs on the same device; assumes worst-case output combination
HSTL Output(s) and CMOS Output(s)			424	622	ps	Outputs on the same device; assumes worst-case output combination

¹ Output skew is the difference between any two similar delay paths while operating at the same voltage and temperature.

LOGIC INPUTS

Table 4.

Parameter	Symbol	Min	Typ	Max	Unit	Test Conditions/Comments
LOGIC INPUTS $\overline{\text{RESET}}$, $\overline{\text{SYNC}}$, IN_SEL						
Input Voltage						
High	V_{IH}	1.7			V	2.5 V supply voltage operation
		2.0			V	3.3 V supply voltage operation
Low	V_{IL}		0.7		V	2.5 V supply voltage operation
			0.8		V	3.3 V supply voltage operation
Input Current	I_{INH} , I_{INL}	-300		+100	μA	
Input Capacitance	C_{IN}		2		pF	

SERIAL PORT SPECIFICATIONS—SPI MODE

Table 5.

Parameter	Min	Typ	Max	Unit	Test Conditions/Comments
CS					SCLK has a 200 k Ω internal pull-down resistor
Input Voltage					
Logic 1	$V_{DD} - 0.4$			V	
Logic 0			0.4	V	
Input Current					
Logic 1		-4		μA	
Logic 0		-85		μA	
Input Capacitance		2		μA	
SCLK					
Input Voltage					
Logic 1	$V_{DD} - 0.4$			V	
Logic 0			0.4	V	
Input Current					
Logic 1		70		μA	
Logic 0		13		μA	
Input Capacitance		2		pF	
SDIO					
As Input					
Input Voltage					
Logic 1	$V_{DD} - 0.4$			V	
Logic 0			0.4	V	
Input Current					
Logic 1		-1		μA	
Logic 0		-1		μA	
Input Capacitance		2		pF	

Parameter	Min	Typ	Max	Unit	Test Conditions/Comments
As Output					
Output Voltage					
Logic 1	VDD – 0.4			V	1 mA load current
Logic 0			0.4	V	1 mA load current
SDO					
Output Voltage					
Logic 1	VDD – 0.4			V	1 mA load current
Logic 0			0.4	V	1 mA load current
TIMING					
SCLK					
Clock Rate, 1/t _{CLK}			30	MHz	
Pulse Width High, t _{HIGH}	4.6			ns	
Pulse Width Low, t _{LOW}	3.5			ns	
SDIO to SCLK Setup, t _{DS}	2.9			ns	
SCLK to SDIO Hold, t _{DH}	0			ns	
SCLK to Valid SDIO and SDO, t _{DV}			15	ns	
$\overline{\text{CS}}$ to SCLK Setup (t _s)	3.4			ns	
$\overline{\text{CS}}$ to SCLK Hold (t _c)	0			ns	
$\overline{\text{CS}}$ to Minimum Pulse Width High	3.4			ns	

SERIAL PORT SPECIFICATIONS—I²C MODE

Table 6.

Parameter	Min	Typ	Max	Unit	Test Conditions/Comments
SDA, SCL (AS INPUT)					
Input Voltage					
Logic 1	VDD – 0.4			V	
Logic 0			0.4	V	
Input Current	–40		0	μA	For V _{IN} = 10% to 90% DVDD3
Hysteresis of Schmitt Trigger Inputs	150			mV	
SDA (AS OUTPUT)					
Output Logic 0 Voltage			0.4	V	I _o = 3 mA
Output Fall Time from V _{IH(MIN)} to V _{IL(MAX)}			250	ns	10 pF ≤ C _b ≤ 400 pF
TIMING					
SCL Clock Rate			400	kHz	
Bus-Free Time Between a Stop and Start Condition, t _{BUF}	1.3			μs	
Repeated Start Condition Setup Time, t _{SU;STA}			0.6	μs	
Repeated Hold Time Start Condition, t _{HD;STA}	0.6			μs	After this period, the first clock pulse is generated
Stop Condition Setup Time, t _{SU;STO}	0.6			μs	
Low Period of the SCL Clock, t _{LOW}	1.3			μs	
High Period of the SCL Clock, t _{HIGH}	0.6			μs	
Data Setup Time, t _{SU;DAT}	100			ns	
Data Hold Time, t _{HD;DAT}	0		0.9	μs	

EXTERNAL RESISTOR VALUES FOR PIN STRAPPING MODE

Table 7.

Parameter	Resistor Polarity	Min	Typ	Max	Unit	Test Conditions/Comments
EXTERNAL RESISTORS						
Voltage Level 0	Pull down to ground		820		Ω	Using 10% tolerance resistor
Voltage Level 1	Pull down to ground		1.8		k Ω	
Voltage Level 2	Pull down to ground		3.9		k Ω	
Voltage Level 3	Pull down to ground		8.2		k Ω	
Voltage Level 4	Pull up to VDD		820		Ω	
Voltage Level 5	Pull up to VDD		1.8		k Ω	
Voltage Level 6	Pull up to VDD		3.9		k Ω	
Voltage Level 7	Pull up to VDD		8.2		k Ω	

CLOCK OUTPUT ADDITIVE PHASE NOISE

Table 8.

Parameter	Min	Typ	Max	Unit	Test Conditions/Comments
CLK-TO-HSTL OR LVDS ADDITIVE PHASE NOISE					
CLK = 1474.56 MHz, OUTx = 1474.56 MHz					Input slew rate > 1 V/ns
Divide Ratio = 1					
At 10 Hz Offset		-88		dBc/Hz	
At 100 Hz Offset		-100		dBc/Hz	
At 1 kHz Offset		-109		dBc/Hz	
At 10 kHz Offset		-116		dBc/Hz	
At 100 kHz Offset		-135		dBc/Hz	
At 1 MHz Offset		-144		dBc/Hz	
At 10 MHz Offset		-148		dBc/Hz	
At 100 MHz Offset		-149		dBc/Hz	
CLK-TO-HSTL OR LVDS or CMOS ADDITIVE PHASE NOISE					
CLK = 625 MHz, OUTx = 125 MHz					Input slew rate > 1 V/ns
Divide Ratio = 5					
At 10 Hz Offset		-114		dBc/Hz	
At 100 Hz Offset		-125		dBc/Hz	
At 1 kHz Offset		-133		dBc/Hz	
At 10 kHz Offset		-141		dBc/Hz	
At 100 kHz Offset		-159		dBc/Hz	
At 1 MHz Offset		-162		dBc/Hz	
At 10 MHz Offset		-163		dBc/Hz	
At 20 MHz Offset		-163		dBc/Hz	
CLK-TO-HSTL OR LVDS ADDITIVE PHASE NOISE					
CLK = 491.52 MHz, OUTx = 491.52 MHz					Input slew rate > 1 V/ns
Divide Ratio = 1					
At 10 Hz Offset		-100		dBc/Hz	
At 100 Hz Offset		-111		dBc/Hz	
At 1 kHz Offset		-120		dBc/Hz	
At 10 kHz Offset		-127		dBc/Hz	
At 100 kHz Offset		-146		dBc/Hz	
At 1 MHz Offset		-153		dBc/Hz	
At 10 MHz Offset		-153		dBc/Hz	
At 20 MHz Offset		-153		dBc/Hz	

CLOCK OUTPUT ADDITIVE TIME JITTER

Table 9.

Parameter	Min	Typ	Max	Unit	Test Conditions/Comments	
LVDS OUTPUT ADDITIVE TIME JITTER CLK = 622.08 MHz, Outputs = 622.08 MHz		41		fs rms	BW = 12 kHz to 20 MHz	
		70		fs rms	BW = 20 kHz to 80 MHz	
		69		fs rms	BW = 50 kHz to 80 MHz	
	CLK = 622.08 MHz, Outputs = 155.52 MHz		93		fs rms	BW = 12 kHz to 20 MHz
			144		fs rms	BW = 20 kHz to 80 MHz
			142		fs rms	BW = 50 kHz to 80 MHz
	CLK = 125 MHz, Outputs = 125 MHz		105		fs rms	BW = 12 kHz to 20 MHz
			209		fs rms	BW = 20 kHz to 80 MHz
			206		fs rms	BW = 50 kHz to 80 MHz
	CLK = 400 MHz, Outputs = 50 MHz		184		fs rms	BW = 12 kHz to 20 MHz
HSTL OUTPUT ADDITIVE TIME JITTER CLK = 622.08 MHz, Outputs = 622.08 MHz		41		fs rms	BW = 12 kHz to 20 MHz	
		56		fs rms	BW = 100 Hz to 20 MHz	
		72		fs rms	BW = 20 kHz to 80 MHz	
		70		fs rms	BW = 50 kHz to 80 MHz	
	CLK = 622.08 MHz, Outputs = 155.52 MHz		76		fs rms	BW = 12 kHz to 20 MHz
			87		fs rms	BW = 100 Hz to 20 MHz
			158		fs rms	BW = 20 kHz to 80 MHz
			156		fs rms	BW = 50 kHz to 80 MHz
	CMOS OUTPUT ADDITIVE TIME JITTER CLK = 100 MHz, Outputs = 100 MHz		91		fs rms	BW = 12 kHz to 20 MHz

ABSOLUTE MAXIMUM RATINGS

Table 10.

Parameter	Rating
Supply Voltage (VDD)	3.6 V
Maximum Digital Input Voltage CLK and $\overline{\text{CLK}}$	−0.5 V to VDD + 0.5 V
Maximum Digital Output Voltage	−0.5 V to VDD + 0.5 V
Storage Temperature Range	−65°C to +150°C
Operating Temperature Range	−40°C to +85°C
Lead Temperature (Soldering 10 sec)	300°C
Junction Temperature	150°C

Stresses at or above those listed under Absolute Maximum Ratings may cause permanent damage to the product. This is a stress rating only; functional operation of the product at these or any other conditions above those indicated in the operational section of this specification is not implied. Operation beyond the maximum operating conditions for extended periods may affect product reliability.

The following equation determines the junction temperature on the application PCB:

$$T_j = T_{\text{CASE}} + (\Psi_{JT} \times P_D)$$

where:

T_j is the junction temperature (°C).

T_{CASE} is the case temperature (°C) measured by the customer at the top center of the package.

Ψ_{JT} is the value as indicated in Table 11.

P_D is the power dissipation.

Values of θ_{JA} are provided for package comparison and PCB design considerations. θ_{JA} can be used for a first-order approximation of T_j by the following equation:

$$T_j = T_A + (\theta_{JA} \times P_D)$$

where T_A is the ambient temperature (°C).

Values of θ_{JC} are provided for package comparison and PCB design considerations when an external heat sink is required.

Values of θ_{JB} are provided for package comparison and PCB design considerations.

THERMAL CHARACTERISTICS

Thermal characteristics established using JEDEC51-7 and JEDEC51-5 2S2P test boards.

Table 11. Thermal Characteristics, 24-Lead LFCSP

Symbol	Thermal Characteristic (JEDEC51-7 and JEDEC51-5 2S2P Test Boards ¹)	Value ²	Unit
θ_{JA}	Junction-to-ambient thermal resistance per JEDEC JESD51-2 (still air)	43.5	°C/W
θ_{JMA}	Junction-to-ambient thermal resistance, 1.0 m/sec airflow per JEDEC JESD51-6 (moving air)	40	°C/W
θ_{JMA}	Junction-to-ambient thermal resistance, 2.5 m/sec airflow per JEDEC JESD51-6 (moving air)	38.5	°C/W
θ_{JB}	Junction-to-board thermal resistance per JEDEC JESD51-8 (still air)	16.2	°C/W
θ_{JC}	Junction-to-case thermal resistance (die-to-heat sink) per MIL-STD-883, Method 1012.1	7.1	°C/W
Ψ_{JT}	Junction-to-top-of-package characterization parameter per JEDEC JESD51-2 (still air)	0.33	°C/W

¹ The exposed pad on the bottom of the package must be soldered to ground (VSS) to achieve the specified thermal performance.

² Results are from simulations. The PCB is a JEDEC multilayer type. Thermal performance for actual applications requires careful inspection of the conditions in the application to determine if they are similar to those assumed in these calculations.

ESD CAUTION



ESD (electrostatic discharge) sensitive device. Charged devices and circuit boards can discharge without detection. Although this product features patented or proprietary protection circuitry, damage may occur on devices subjected to high energy ESD. Therefore, proper ESD precautions should be taken to avoid performance degradation or loss of functionality.

PIN CONFIGURATION AND FUNCTION DESCRIPTIONS

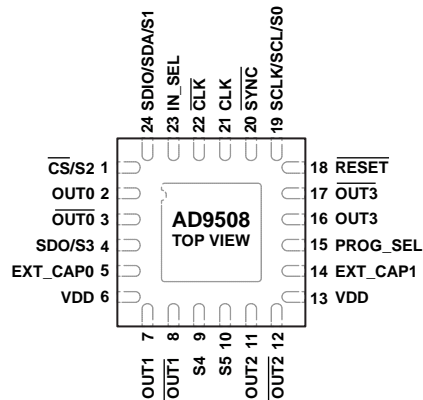

- NOTES
1. THE EXPOSED DIE PAD MUST BE CONNECTED TO GROUND (VSS).

1161-002

Figure 2. Pin Configuration

Table 12. Pin Function Descriptions

Pin No.	Mnemonic	Description
1	$\overline{CS}/S2$	Chip Select/Pin Programming. Multipurpose pin. This pin is controlled by the PROG_SEL pin. Chip Select (\overline{CS}) is an active logic low CMOS input used in the SPI operation mode. When programming a device via SPI mode, \overline{CS} must be held low. In systems where more than one AD9508 is present, this pin enables individual programming of each AD9508. In pin programming mode, this pin becomes S2. In this mode, S2 is hard wired with a resistor to either VDD or ground. The resistor value and resistor biasing determine the output divider value for the outputs on Pin 11 and Pin 12. See the Pin Strapping to Program on Power-Up section for more details.
2	OUT0	LVDS/HSTL Differential Output or Single-Ended CMOS Output.
3	$\overline{OUT0}$	Complementary LVDS/HSTL Differential Output or Single-Ended CMOS Output.
4	SDO/S3	Serial Data Output/Pin Programming. Multipurpose pin. This pin is controlled by the PROG_SEL pin. SDO is configured as an output to read back the internal register settings in SPI mode operation. In pin programming mode, this pin becomes S3, which is hard wired with a resistor to either VDD or ground. The resistor value and resistor biasing determine the output divider value for the outputs on Pin 16 and Pin 17. See the Pin Strapping to Program on Power-Up section for more details.
5	EXT_CAP0	Node for External Decoupling Capacitor for LDO. Tie this pin to a 0.47 μF capacitor to ground.
6	VDD	Power Supply (2.5 V or 3.3 V Operation).
7	OUT1	LVDS/HSTL Differential Output or Single-Ended CMOS Output.
8	$\overline{OUT1}$	Complementary LVDS/HSTL Differential Output or Single-Ended CMOS Output.
9	S4	Pin Programming. Use this pin in pin programming mode only. The PROG_SEL pin determines which programming mode is used. In pin programming mode, S4 is hardwired with a resistor to either VDD or ground. The resistor value and resistor biasing determine the output logic levels used for the outputs on Pin 2, Pin 3, Pin 7, and Pin 8. See the Pin Strapping to Program on Power-Up section for more details.
10	S5	Pin Programming. Use this pin in pin programming mode only. The PROG_SEL pin determines which programming mode is used. In pin programming mode, S5 is hardwired with a resistor to either VDD or ground. The resistor value and resistor biasing determine the output logic levels used for the outputs on Pin 11, Pin 12, Pin 16, and Pin 17. See the Pin Strapping to Program on Power-Up section for more details.
11	OUT2	LVDS/HSTL Differential Output or Single-Ended CMOS Output.
12	$\overline{OUT2}$	Complementary LVDS/HSTL Differential Output or Single-Ended CMOS Output.
13	VDD	Power Supply (2.5 V or 3.3 V Operation).
14	EXT_CAP1	Node for External Decoupling Capacitor for LDO. Tie this pin to a 0.47 μF capacitor to ground.
15	PROG_SEL	Three-State CMOS Input. Pin 15 selects the type of device programming interface to be used (SPI, I ² C, or pin programming).
16	OUT3	LVDS/HSTL Differential Output or Single-Ended CMOS Output.
17	$\overline{OUT3}$	Complementary LVDS/HSTL Differential Output or Single-Ended CMOS Output.

Pin No.	Mnemonic	Description
18	$\overline{\text{RESET}}$	CMOS Input. Device Reset. When this active low pin is asserted, the internal register settings enter their default state after the $\overline{\text{RESET}}$ is released. Note that $\overline{\text{RESET}}$ also serves as a power-down of the device while an active low signal is applied to the pin. The $\overline{\text{RESET}}$ pin has an internal 24 k Ω pull-up resistor.
19	SCLK/SCL/S0	Serial Programming Clock/Data Clock/Programming Pin. Multipurpose pin controlled by the PROG_SEL pin used for serial programming clock (SCLK) in SPI mode or data clock (SCL) for serial programming in I ² C Mode. The PROG_SEL pin determines which programming mode is used. In pin programming mode, this pin becomes S0. In this mode, S0 is hardwired with a resistor to either VDD or ground. The resistor value and resistor biasing determine the output divider values for the outputs on Pin 2 and Pin 3. See the Pin Strapping to Program on Power-Up section for more details.
20	$\overline{\text{SYNC}}$	Clock Synchronization. When this pin is active low, the output drivers are held static and then synchronized on a low-to-high transition of this pin. The $\overline{\text{SYNC}}$ pin has an internal 24 k Ω pull-up resistor.
21	CLK	Differential Clock Input or Single-Ended CMOS Input. Whether this pin serves as the differential clock input or the single-ended CMOS input depends on the logic state of the IN_SEL pin.
22	$\overline{\text{CLK}}$	Complementary Differential Clock Input.
23	IN_SEL	CMOS Input. A logic high configures the CLK and $\overline{\text{CLK}}$ inputs for a differential input signal. A logic low configures the input for single-ended CMOS applied to the CLK pin. AC-couple the unused $\overline{\text{CLK}}$ to ground with a 0.1 μF capacitor.
24	SDIO/SDA/S1	Serial Data Input and Output (SPI)/Serial Data (I ² C)/Pin Programming. Pin 24 is a multipurpose input controlled by the PROG_SEL pin used for SPI (SDIO), I ² C (SDA), and pin strapping modes (S1). When the device is in 4-wire SPI mode, data is written via SDIO. In 3-wire mode, both data reads and writes occur on this pin. There is no internal pull-up/pull-down resistor on this pin. In I ² C mode, SDA serves as the serial data pin. The PROG_SEL pin determines which programming mode is used. In pin programming mode, this pin becomes S1. In this mode, S1 is hardwired with a resistor to either VDD or ground. The resistor value and resistor biasing determine the output divider values for the outputs on Pin 7 and Pin 8. See the Pin Strapping to Program on Power-Up section for more details.
	EP	Exposed Pad. The exposed die pad must be connected to ground (VSS).

TYPICAL PERFORMANCE CHARACTERISTICS

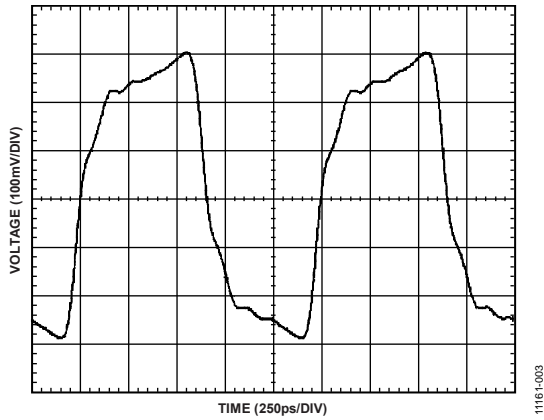

Figure 3. LVDS Differential Output Waveform at 800 MHz

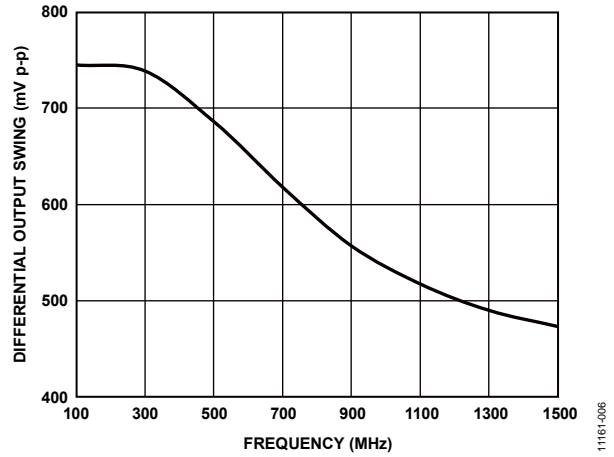

Figure 6. LVDS Differential Output Swing vs. Frequency

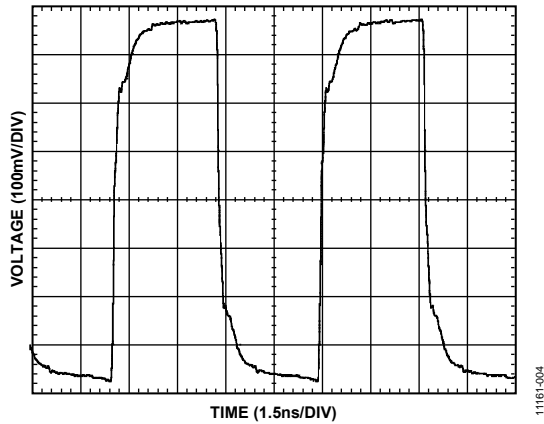

Figure 4. LVDS Differential Output Waveform at 156.25 MHz

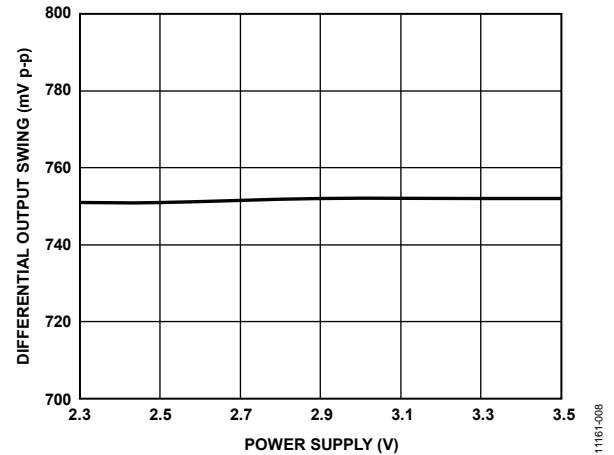

Figure 7. LVDS Differential Output Swing vs. Power Supply Voltage

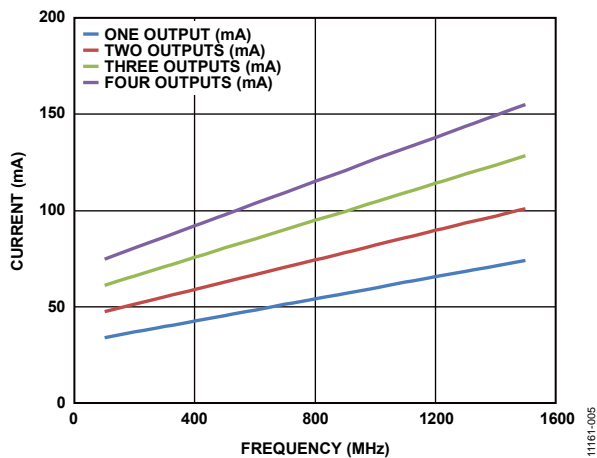

Figure 5. Power Supply Current vs. Input Frequency and Number of Outputs Used, LVDS

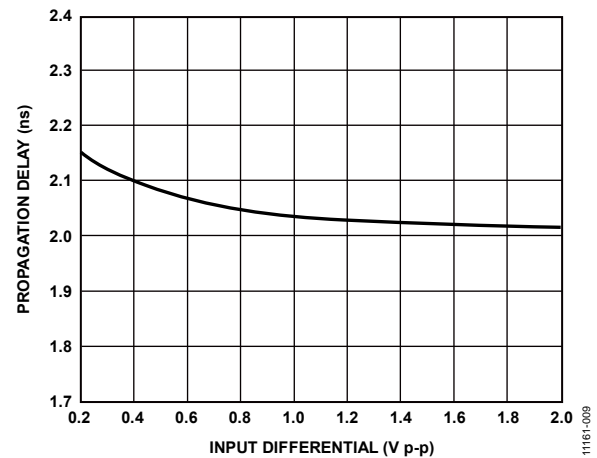

Figure 8. LVDS Propagation Delay vs. Input Differential Voltage

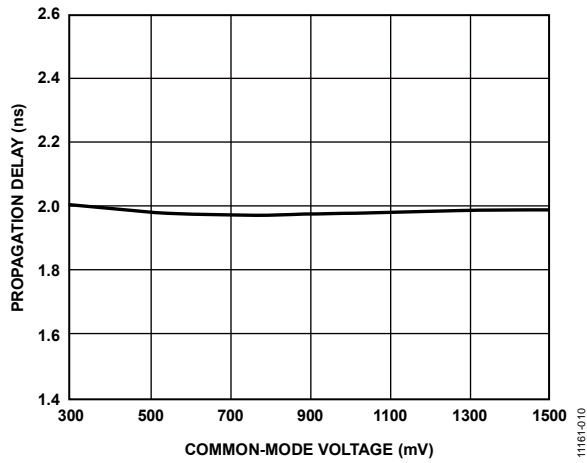

Figure 9. LVDS Propagation Delay vs. Input Common-Mode Voltage

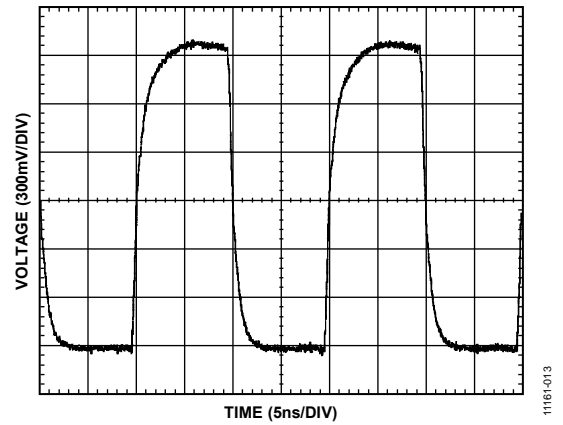

Figure 12. CMOS Output Waveform at 50 MHz with 10 pF Load

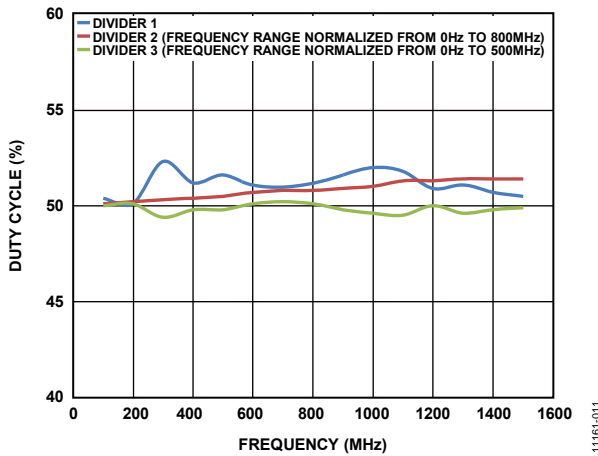

Figure 10. LVDS Output Duty Cycle vs. Output Frequency

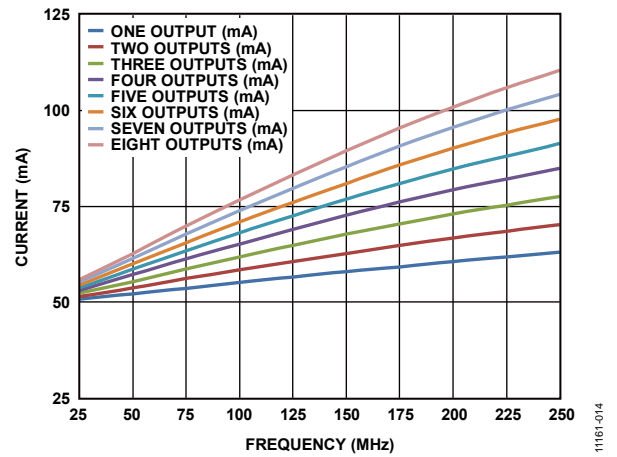

Figure 13. Power Supply Current vs. Input Frequency vs. Number of Outputs Used, CMOS

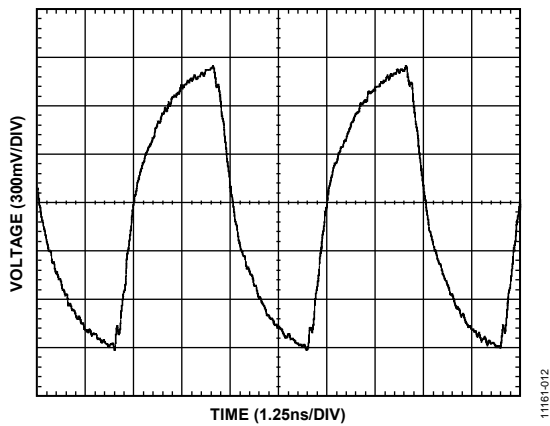

Figure 11. CMOS Output Waveform at 200 MHz with 10 pF Load

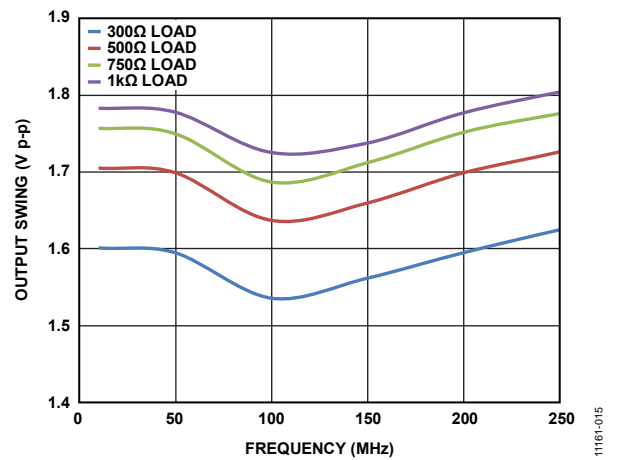

Figure 14. CMOS Output Swing vs. Frequency and Resistive Load

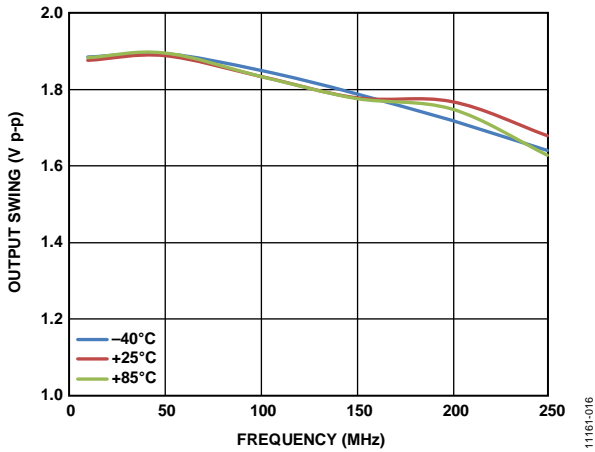

Figure 15. CMOS Output Swing vs. Frequency and Temperature (10 pF Load)

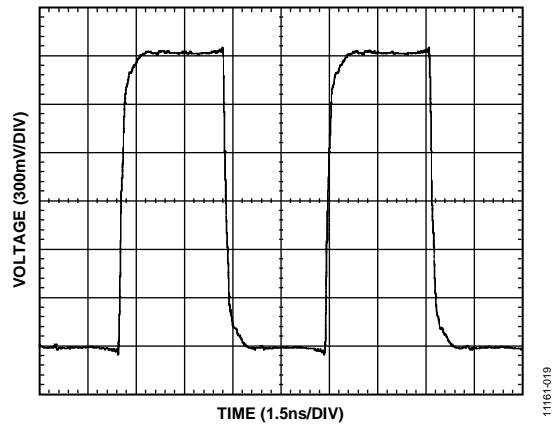

Figure 18. HSTL Differential Output Waveform at 156.25 MHz

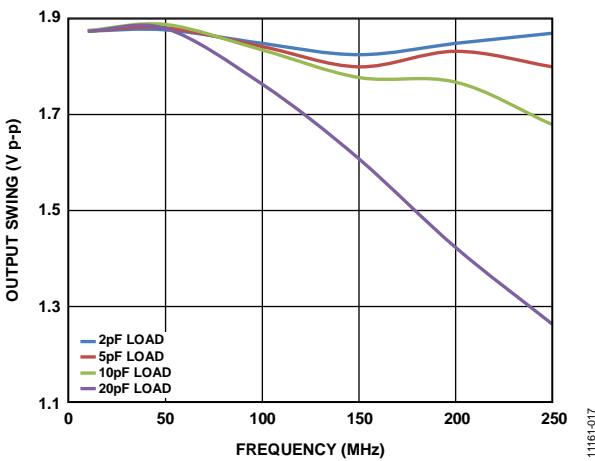

Figure 16. CMOS Output Swing vs. Frequency and Capacitive Load (2 pF, 5 pF, 10 pF, 20 pF)

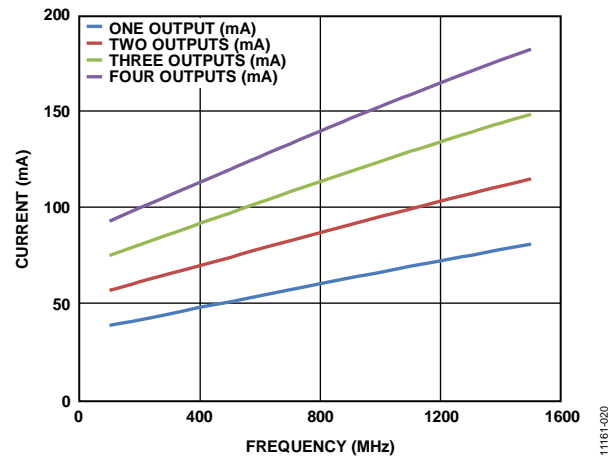

Figure 19. Power Supply Current vs. Input Frequency and Number of Outputs Used, HSTL

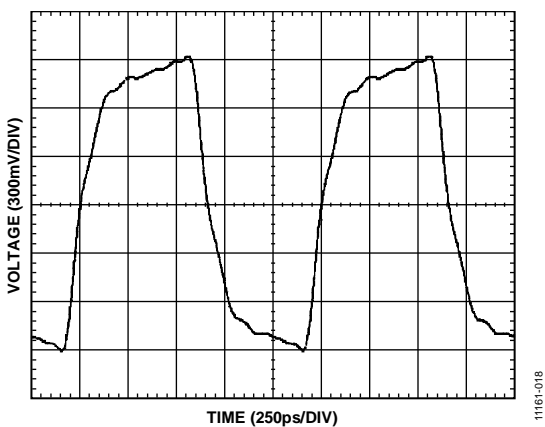

Figure 17. HSTL Differential Output Waveform at 800 MHz

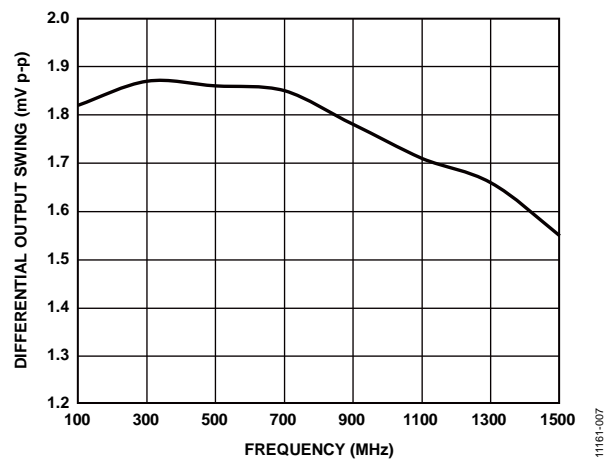

Figure 20. HSTL Differential Output Swing vs. Frequency

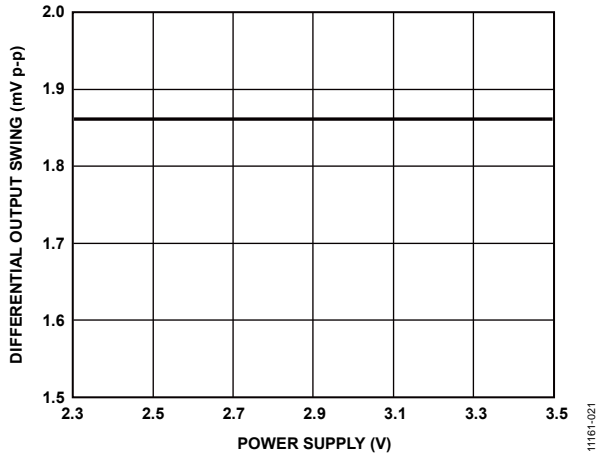

Figure 21. HSTL Differential Output Swing vs. Power Supply Voltage

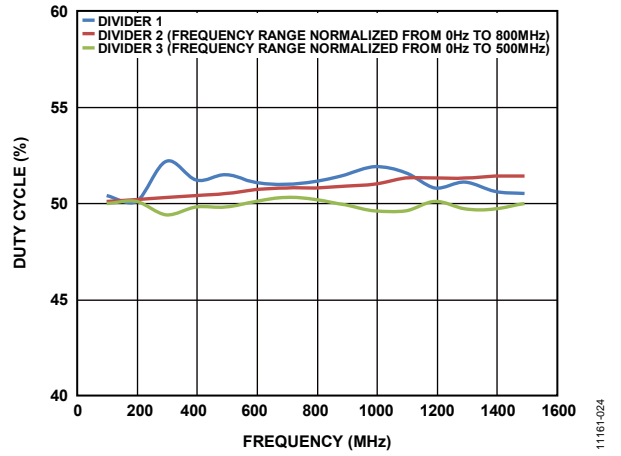

Figure 24. HSTL Output Duty Cycle vs. Output Frequency

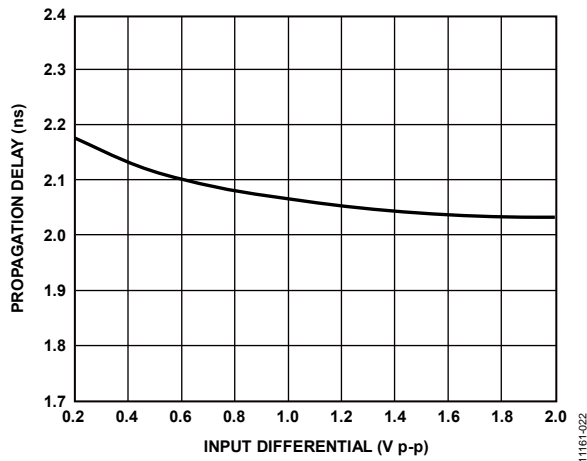

Figure 22. HSTL Propagation Delay vs. Input Differential Voltage

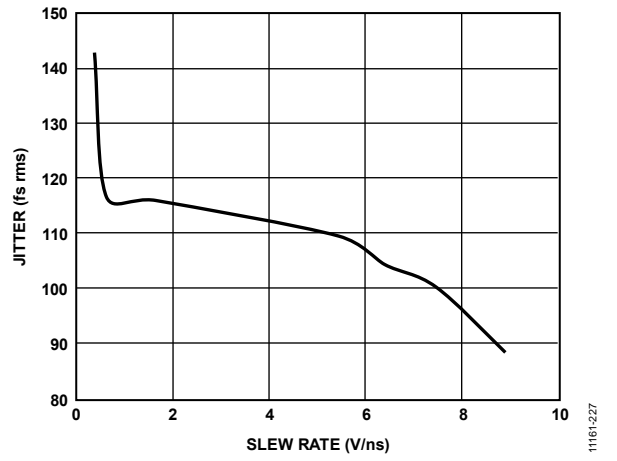

Figure 25. Additive Broadband Jitter vs. Input Slew Rate, LVDS, HSTL (Calculated from SNR of ADC Method)

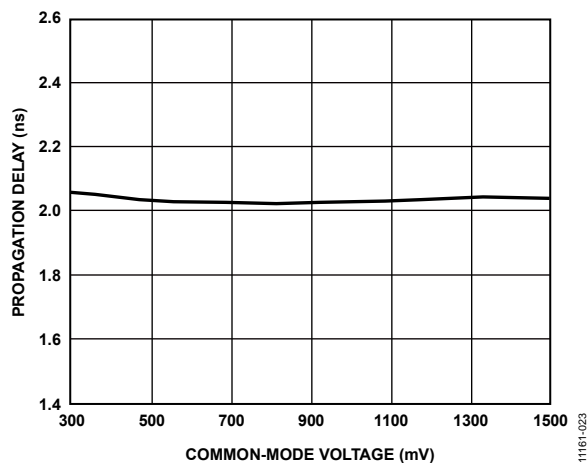

Figure 23. HSTL Propagation Delay vs. Input Common-Mode Voltage

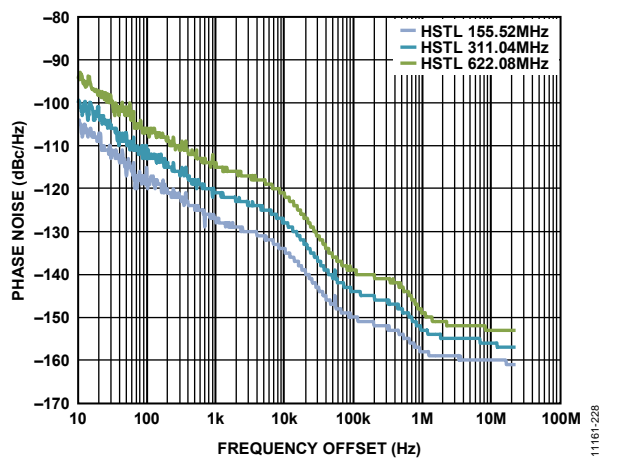

Figure 26. Absolute Phase Noise in HSTL Mode with Clock Input at 622.08 MHz and Outputs = 622.08 MHz, 311.04 MHz, 155.52 MHz

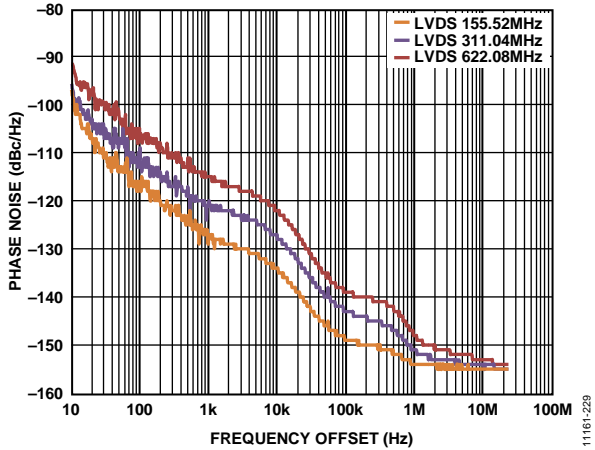

Figure 27. Absolute Phase Noise in LVDS Mode with Clock Input at 622.08 MHz and Outputs = 622.08 MHz, 311.04 MHz, 155.52 MHz

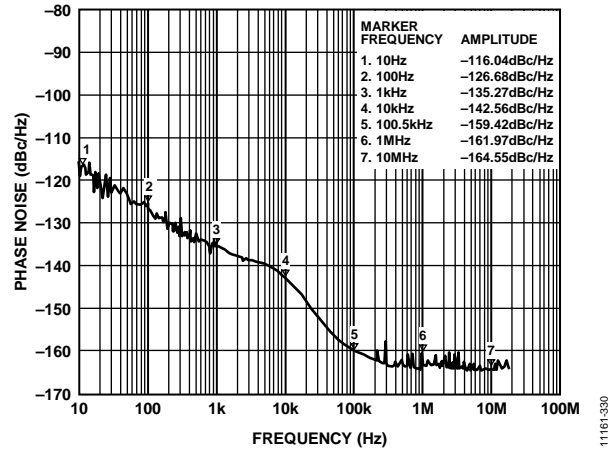

Figure 30. Additive Phase Noise with Clock Input = 1500 MHz with HSTL Outputs = 100 MHz

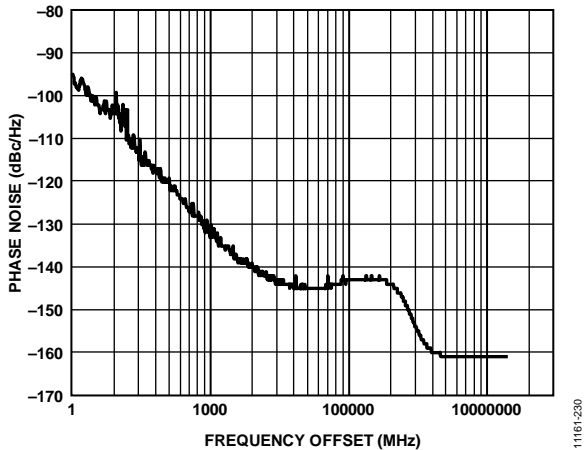

Figure 28. Absolute Phase Noise of Clock Source at 622.08 MHz

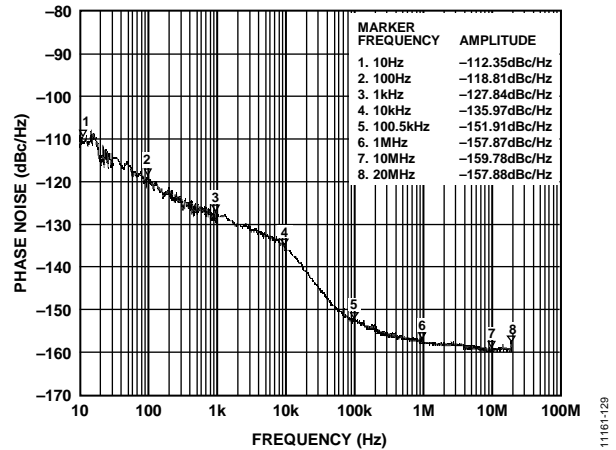

Figure 31. Additive Phase Noise with Clock Input = 622.08 MHz with HSTL Outputs = 155.52 MHz

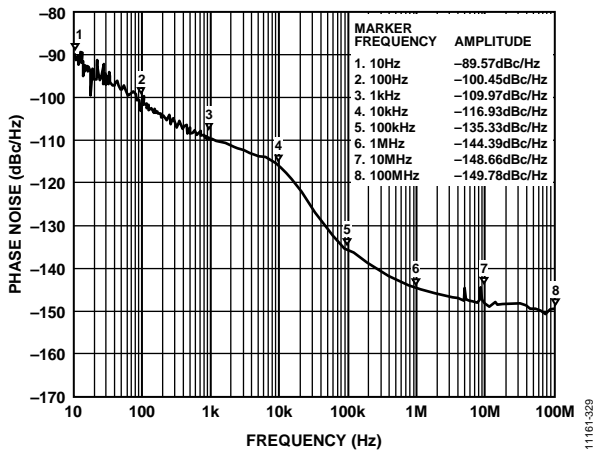

Figure 29. Additive Phase Noise with Clock Input = 1474.56 MHz with HSTL Outputs = 1474.76 MHz

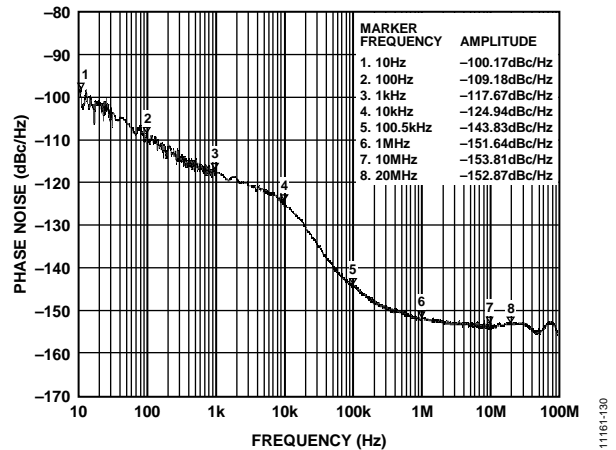

Figure 32. Additive Phase Noise with Clock Input = 622.08 MHz with LVDS Outputs = 622.08 MHz

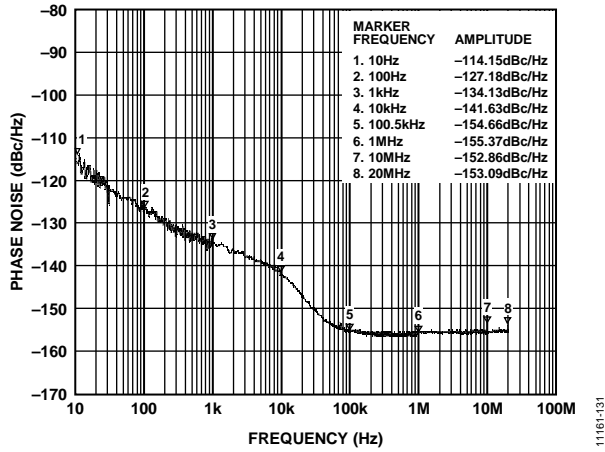
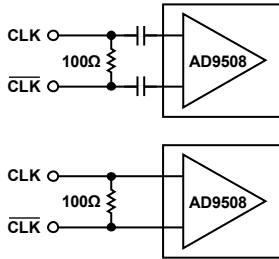

Figure 33. Additive Phase Noise with Clock Input = 100 MHz with CMOS Outputs = 100 MHz

TEST CIRCUITS

INPUT/OUTPUT TERMINATION RECOMMENDATIONS



11161-132

Figure 34. Typical AC-Coupled or DC-Coupled LVDS or HSTL Configurations

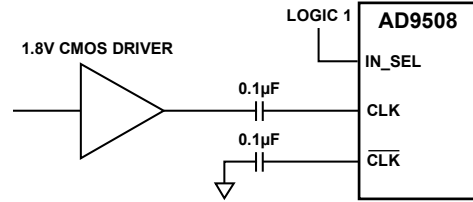

11161-200

Figure 38. 1.8 V CMOS Logic Configuration for Input Clock Using Differential Mode

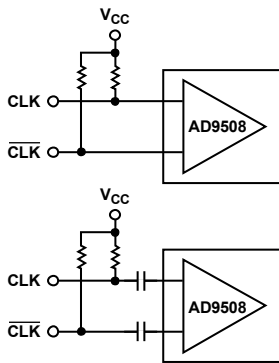

11161-133

Figure 35. Typical AC-Coupled or DC-Coupled CML Configurations

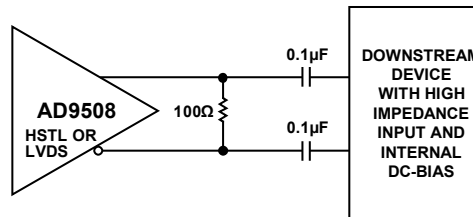

11161-136

Figure 39. AC-Coupled LVDS or HSTL Output Driver (100 Ω Resistor Can Go on Either Side of Decoupling Capacitors Placed As Close As Possible To The Destination Receiver)

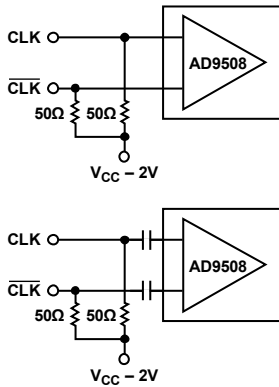

11161-134

Figure 36. Typical AC-Coupled or DC-Coupled LVPECL Configurations

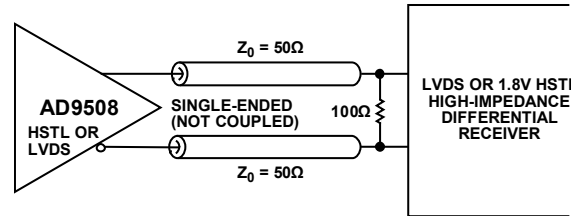

11161-137

Figure 40. DC-Coupled LVDS or HSTL Output Driver

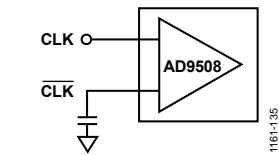

11161-135

Figure 37. Typical 2.5 V or 3.3 V CMOS Configurations for Short Trace Lengths

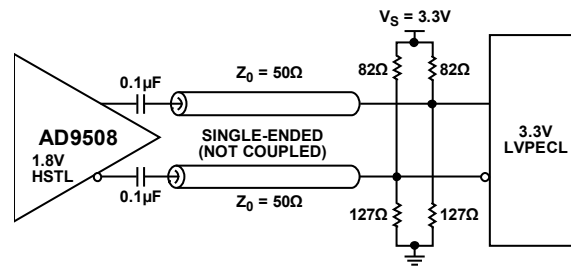

11161-138

Figure 41. Interfacing the HSTL Driver to a 3.3 V LVPECL Input (This Method Incorporates Impedance Matching and DC Biasing for Bipolar LVPECL Receivers. If the Receiver Is Self-Biased, the Termination Scheme Shown in Figure 39 Is Recommended.)

TERMINOLOGY

Phase Jitter and Phase Noise

An ideal sine wave can be thought of as having a continuous and an even progression phase with time from 0 degrees to 360 degrees for each cycle. Actual signals, however, display a certain amount of variation from ideal phase progression over time. This phenomenon is phase jitter. Although many causes can contribute to phase jitter, one major cause is random noise, characterized statistically as being Gaussian (normal) in distribution.

Phase jitter leads to a spreading out of the energy of the sine wave in the frequency domain, producing a continuous power spectrum. This power spectrum is usually reported as a series of values whose units are dBc/Hz at a given offset in frequency from the sine wave (carrier). The value is a ratio (expressed in dB) of the power contained within a 1 Hz bandwidth with respect to the power at the carrier frequency. For each measurement, the offset from the carrier frequency is also given.

It is meaningful to integrate the total power contained within some interval of offset frequencies (for example, 10 kHz to 10 MHz). This is called the integrated phase noise over that frequency offset interval and can be readily related to the time jitter due to the phase noise contained within that offset frequency interval.

Phase noise has a detrimental effect on the performance of ADCs, DACs, and RF mixers. It lowers the achievable dynamic range of the converters and mixers, although they are affected in somewhat different ways.

Time Jitter

Phase noise is a frequency domain phenomenon. In the time domain, the same effect is exhibited as with time jitter. When observing a sine wave, the time of successive zero crossings varies.

In a square wave, the time jitter is a displacement of the edges from their ideal (regular) times of occurrence. In both cases, the variations in timing from the ideal are the time jitter. Because these variations are random in nature, the time jitter is specified in units of seconds root mean square (rms) or one sigma of the Gaussian distribution.

Time jitter that occurs on a sampling clock for a DAC or an ADC decreases the SNR and dynamic range of the converter. A sampling clock with the lowest possible jitter provides the highest performance from a given converter.

Additive Phase Noise

Additive phase noise is the amount of phase noise that is attributable only to the device or subsystem being measured. The residual phase noise system makes use of two devices operating in perfect quadrature. The correlated noise of any external components common to both devices (such as clock sources) is not present. This makes it possible to predict the degree to which the device is going to affect the total system phase noise when used in conjunction with the various oscillators and clock sources, each of which contribute their own phase noise to the total. In many cases, the phase noise of one element dominates the system phase noise.

Additive Time Jitter

Additive time jitter refers to the amount of time jitter that is attributable to the device or subsystem being measured. It is calculated by integrating the additive phase noise over a specific range. This makes it possible to predict the degree to which the device is going to impact the total system time jitter when used in conjunction with the various oscillators and clock sources, each of which contribute their own time jitter to the total. In many cases, the time jitter of the external oscillators and clock sources dominates the system time jitter.

THEORY OF OPERATION

DETAILED BLOCK DIAGRAM

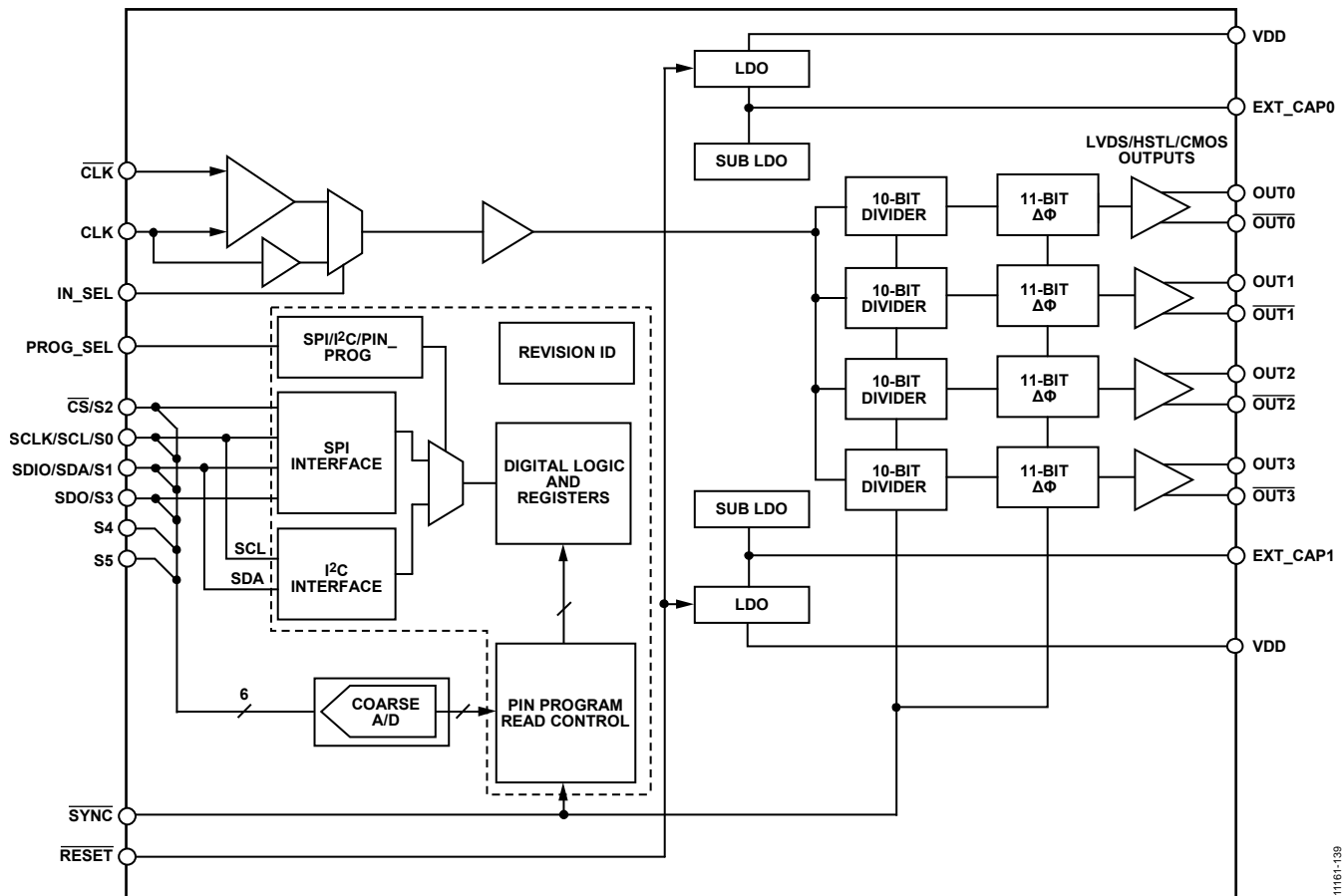

Figure 42. Detailed Block Diagram

The [AD9508](#) accepts either a differential input clock applied to the CLK and $\overline{\text{CLK}}$ pins or a single-ended 1.8 V (if ac-coupled) 2.5 V or 3.3 V CMOS clock applied to the CLK pin. The input clock signal is sent to the clock distribution section, which has programmable dividers and phase offset adjustment. The clock distribution section operates at speeds of up to 1650 MHz.

The divider range under SPI or I²C control ranges from 1 to divide-by-1024 and the phase offset adjustment is equipped with 11 bits of resolution. However, in pin programming mode, the divider range is limited to a maximum divide-by-16 and there is no phase offset adjustment available.

The outputs can be configured to as many as four LVDS/HSTL differential outputs or as many as eight 1.8 V CMOS single-ended outputs. In addition, the output current for the different outputs is adjustable for output drive strength.

The device can be powered with either a 3.3 V or 2.5 V external supply; however, the internal supply on the chip runs off an internal 1.8 V LDO, delivering high performance with minimal power consumption.

PROGRAMMING MODE SELECTION

The [AD9508](#) supports both SPI and I²C protocols, and a pin strapping option to program the device. The active interface depends on the logic state of the PROG_SEL pin. See Table 13 for programming mode selections. See the Serial Control Port and Pin Strapping to Program on Power-Up sections for more detailed information.

Table 13. SPI/I²C/Pin Serial Port Setup

PROG_SEL	SPI/I ² C/Pin
Float	SPI
Logic 0	I ² C
Logic 1	Pin programming control

11161-139

CLOCK INPUT

The IN_SEL pin controls the desired input clock configuration. When the IN_SEL pin is set for single-ended operation, the device expects 1.8 V (if ac-coupled), 2.5 V, or 3.3 V CMOS-compatible logic levels on the CLK input pin. Bypass the unused $\overline{\text{CLK}}$ pin to ground with a 0.1 μF capacitor.

Note that if 2.5 V CMOS logic is used for single-ended input clock mode, the 2.5 V power supply option is recommended instead of 3.3 V operation to avoid possible duty cycle distortion. Duty cycle distortion can occur when the switching threshold level ($V_{\text{DD}}/2$ or 1.65 V for 3.3 V operation) is increased and slow rise and falls times exist at the clock input.

1.8 V CMOS logic levels are not recommended in a single-ended CMOS configuration due to V_{IH} being too close to the input threshold voltage. However, the differential input clock mode can be used for a 1.8 V CMOS input, and Figure 38 shows the recommended configuration for a 1.8 V CMOS input clock.

When the IN_SEL pin is set for differential input clock mode, the inputs of the AD9508 are internally self biased. The internal inputs have a resistor divider, which sets the common-mode level. The complementary input is biased about 30 mV lower than the true input to avoid oscillations in the event that the input signal ceases. See Figure 43 for the equivalent differential input circuit.

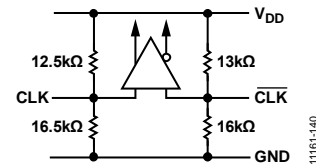

Figure 43. AD9508 Differential Input Stage

The inputs can be ac-coupled or dc-coupled in differential mode. See Table 14 for input logic compatibility. The user can supply a single-ended input with the input in differential mode by ac or dc coupling to one side of the differential input and bypassing the other input to ground by a capacitor.

Note that jitter performance degrades with low input slew rate, as shown in Figure 25. See Figure 34 through Figure 37 for different input clock termination schemes.

Table 14. CLK and $\overline{\text{CLK}}$ Differential Input Logic Compatibility

Input Logic Type	Input Common Mode (V)	Input Voltage Swing (per leg) (V)	AC-Coupled	DC-Coupled
3.3 V CML	2.9	0.8	Yes	Not allowed
2.5 V CML	2.1	0.8	Yes	Not allowed
1.8 V CML	1.4	0.8	Yes	Yes
3.3 V CMOS ¹	1.65	3.3	Not allowed	Yes
2.5 V CMOS ^{1,2}	1.25	2.5	Not allowed	Yes
1.8 V CMOS ³	0.9	1.8	Yes	Not recommended
1.5 V HSTL	0.75	0.75	Yes	Yes
LVDS	1.25	0.4	Yes	Yes
3.3 V LVPECL	2.0	0.8	Yes	Not allowed
2.5 V LVPECL	1.2	0.8	Yes	Yes

¹ IN_SEL is set for single-ended CMOS mode.

² VDD = 2.5 V operation recommended vs. VDD = 3.3 V operation.

³ Refer to Figure 38 for configuration.

CLOCK OUTPUTS

Each output driver can be configured for either a differential LVDS/HSTL output or two single-ended CMOS outputs. When the LVDS/HSTL driver is enabled, the corresponding CMOS driver is in tristate. When the CMOS driver is enabled, the corresponding LVDS/HSTL driver is powered down and tristated. See Figure 44 and Figure 45 for the equivalent output stages.

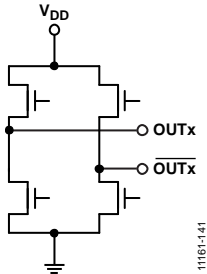

Figure 44. LVDS/HSTL Output Simplified Equivalent Circuit

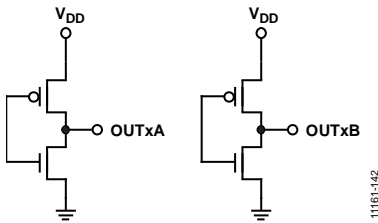

Figure 45. CMOS Equivalent Output Circuit

In LVDS or HSTL modes, there are register settings to control the output logic type and current drive strength. The LVDS output current can be set to the nominal 3.5 mA, additional settings include 0.5, 0.75, 1.0 (default), and 1.25 multiplied by 3.5 mA. The HSTL output current can be set to 8 mA (nominal) or 16 mA (boost mode). For pin programming mode, see the Pin Strapping to Program on Power-Up section for details and limitations of the device. Under pin programming mode, the nominal current is the default setting and is nonadjustable.

When routing single-ended CMOS signals, avoid driving multiple input receivers with one output. Series termination at the source is generally required to provide transmission line matching and/or to reduce current transients at the driver. The value of the series resistor is dependent on the board design and timing requirements (typically 10 Ω to 100 Ω). CMOS outputs are also limited in terms of the capacitive load or trace length that they can drive. Typically, trace lengths less than 3 inches are recommended to preserve signal rise/fall times and signal integrity.

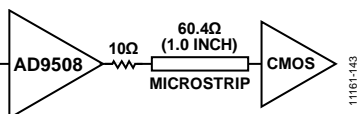

Figure 46. Series Termination of CMOS Output

CLOCK DIVIDERS

The four independent output dividers are 10-bit integer dividers with a divide range of 1 to 1024 in SPI and I²C modes. The output divider block contains duty cycle correction that guarantees 50% duty cycle for both even and odd divide ratios. In pin programming mode, divide values of 1 to 8 and 16 are supported.

PHASE DELAY CONTROL

The AD9508 provides a coarse output phase delay adjustment between outputs but with a wide delay range that is beneficial for some applications. The minimum delay step is equivalent to half the period of the input clock rate. This minimum delay step can be multiplied from 1 to 2047 times the minimum delay step to cover a wide delay range. The multiplication of the minimum delay step is provided for each output via the appropriate internal programming register. Phase delay is not supported in pin programming mode.

Note that the phase delay adjustment requires the use of the SYNC function pin. Phase adjustment and output synchronization occurs on the rising edge of the SYNC pin. Therefore, the SYNC pin must be pulled low and released to produce the desired phase relationship between outputs. If the SYNC is not active low prior to a phase delay change, the desired output phase delay between outputs is not guaranteed to occur; instead, a random phase delay can occur between outputs. However, a future SYNC pulse corrects to the desired phase relationship, if initiated. During the active low SYNC period, the outputs are forced to a static state.

Figure 47 shows three independent outputs, each set for DIV = 4 of the input clock rate. By incrementing the phase offset value in the programming registers from 0 to 2, each output is offset from the initial edge by a multiple of 1/2 t_{CLK}. Note that the SYNC signal is not shown in this timing diagram.

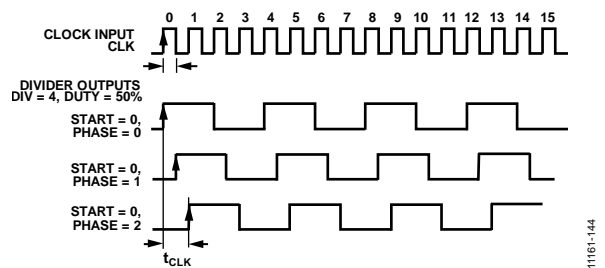

Figure 47. Phase Offset—All Dividers Set for DIV = 4, Phase Set from 0 to 2

RESET MODES

The AD9508 has a power-on reset (POR) and other ways to apply a reset condition to the chip.

Power-On Reset

During chip power-up, an internal power-on reset pulse is issued when VDD reaches ~1.15 V and restores the chip to the default on-chip setting. It takes ~20 ms for the outputs to begin toggling after the power-on reset pulse signal is internally generated.

In SPI or I²C modes, the default power-on state of the AD9508 is configured as a buffer with the dividers set to divide by 1. In pin programmable mode, the part is configured per the hardwiring of the S0 to S5 pins.

Hardware Reset via the $\overline{\text{RESET}}$ Pin

A hard asynchronous reset is executed by briefly pulling $\overline{\text{RESET}}$ low. This restores the chip to the on-chip default register settings. It takes ~20 ms for the outputs to begin toggling after $\overline{\text{RESET}}$ is released.

Soft Reset via the Serial Port

A soft reset is initiated by setting Bit 2 and Bit 5 in Register 0x000. Except for Register 0x000, when Bit 5 and Bit 2 are set, the chip enters a soft reset mode and restores the chip to the on-chip setting. These bits are self clearing. However, the self clearing operation does not complete until an additional serial port SCLK cycle occurs, and the AD9508 is held in reset until that happens.

POWER-DOWN MODE

Individual Clock Divider Power-Down

In SPI or I²C programming mode, the clock distribution dividers can be powered down individually by writing to the appropriate registers. Powering down a clock divider is similar to powering down an individual driver, but it saves more power because additional circuits are also powered down. The register map details the individual power-down settings for each output divider. The power-down bits for individual dividers are found in Register 0x19, Bit 7; Register 0x1F, Bit 7; Register 0x25, Bit 7; and Register 0x2B, Bit 7.

Note that in all three programming modes, a logic low on the $\overline{\text{RESET}}$ pin can be used to power down the device.

OUTPUT CLOCK SYNCHRONIZATION

On power up, the default divider value is divide-by-1 if SPI and I²C programming modes are used. Therefore, there is no requirement for synchronization after power up unless a change in divider value or a phase offset value is desired. The user can synchronize the outputs by pulling the $\overline{\text{SYNC}}$ pin low.

The output drivers are static while the $\overline{\text{SYNC}}$ pin is low, and the outputs are edge aligned, regardless of their divide ratio after the $\overline{\text{SYNC}}$ pin releases.

When the sync mask bit is set to a Logic 1, the associated output continues working uninterrupted while applying a $\overline{\text{sync}}$ operation to other outputs. Outputs are pulled low while $\overline{\text{SYNC}}$ is low if they are not masked by the sync mask bit. This only applies if outputs are functioning under normal operation with its logic level set to 11 or toggle mode.

POWER SUPPLY

The AD9508 is designed to work off a 3.3 V + 5% power supply down to a 2.5 V – 5% power supply. Best practice recommends bypassing the power supply on the printed circuit board (PCB) with adequate capacitance (>10 μF) and bypassing all power pins with adequate capacitance (0.1 μF) as close to the part as possible. The layout of the AD9508 evaluation board (AD9508/PCBZ), available at www.analog.com, provides a good layout example for this device.

THERMALLY ENHANCED PACKAGE MOUNTING GUIDELINES

Exposed Metal Paddle

The exposed metal paddle on the AD9508 package is an electrical connection, as well as a thermal enhancement. For the device to function properly, the paddle must be properly attached to ground (VSS). The AD9508 dissipates heat through its exposed paddle. The PCB acts as a heat sink for the AD9508. The PCB attachment must provide a good thermal path to a larger heat dissipation area, such as the ground plane on the PCB. This requires a grid of vias from the top layer down to the ground plane. See Figure 48 for an example.

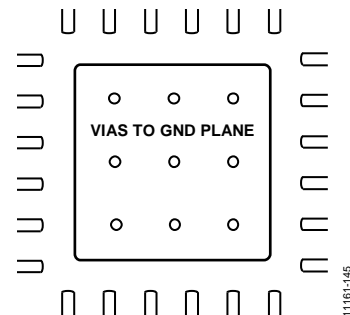

Figure 48. PCB Land Example for Attaching Exposed Paddle

Refer to the AN-772 Application Note, *A Design and Manufacturing Guide for the Lead Frame Chip Scale Package (LFCS)*, for more information about mounting devices with an exposed paddle.

PIN STRAPPING TO PROGRAM ON POWER-UP

The PROG_SEL input when set to Logic 1 places the AD9508 in pin strapping control mode without the need for SPI or I²C operations. In this mode, Pin S0 through Pin S5 program the desired internal divider value and output logic type for each output or to set the output to a high-Z state.

In this mode, the maximum divide value is limited to divide-by-16 and phase offset delay control is not supported. LVDS and HSTL logic types are supported in this mode. However, if HSTL mode is set and the 100 Ω output termination is removed, the output swings to 1.8 V CMOS logic levels. In this configuration, the differential pair of the selected output become two single-ended CMOS signals. Those outputs maintain a 180° phase relationship and share the same divide ratio.

Programming individual outputs and the output logic type is performed by hardwiring specific resistor values to each of the S0 to S5 pins.

The other side of the resistor is then biased to ground or VDD, depending on the desired settings. The actual settings are applied after an internal ADC scans each one of the S0 to S5 pins. An ADC scan is initiated by either the internal power-on reset when the device is powered up or by toggling the SYNC pin. If changes are made after the internal power-on reset, the SYNC pin must be toggled before any new changes are accepted.

Table 15 depicts all the pin strapping selections available for each output divider value and logic type. The resistors listed in Table 15 must have 10% or better tolerance.

Note that if all outputs use an output divider value of one and use either HSTL outputs or 1.8 V CMOS output levels, then the S0 to S5 pins can be grounded to accomplish that particular configuration instead of using the 820 Ω resistor.

Table 15. Selection Table for Pin Strapping Control

Programming Pins	Output	ADC Voltage Level (0 Through 7) vs. Resistor Value vs. Divide Value and Logic Type							
		0 = 820 Ω Pulled to GND	1 = 1.8 kΩ Pulled to GND	2 = 3.9 kΩ Pulled to GND	3 = 8.2 kΩ Pulled to GND	4 = 820 Ω Pulled to VDD	5 = 1.8 kΩ Pulled to VDD	6 = 3.9 kΩ Pulled to VDD	7 = 8.2 kΩ Pulled to VDD
S0	OUT0	÷1	÷2	÷3	÷4	÷5	÷6	÷8	÷16
S1	OUT1	÷1	÷2	÷3	÷4	÷5	÷6	÷8	÷16
S2	OUT2	÷1	÷2	÷3	÷4	÷5	÷6	÷8	÷16
S3	OUT3	÷1	÷2	÷3	÷4	÷5	÷6	÷8	÷16
S4	OUT0	HSTL	LVDS	High-Z	HSTL	LVDS	High-Z	HSTL	High-Z
	OUT1	HSTL	HSTL	HSTL	LVDS	LVDS	LVDS	High-Z	High-Z
S5	OUT2	HSTL	LVDS	High-Z	HSTL	LVDS	High-Z	HSTL	High-Z
	OUT3	HSTL	HSTL	HSTL	LVDS	LVDS	LVDS	High-Z	High-Z

SERIAL CONTROL PORT

The AD9508 serial control port is a flexible, synchronous serial communications port that provides a convenient interface to many industry-standard microcontrollers and microprocessors. The serial control port is compatible with most synchronous transfer formats, including I²C, Motorola SPI, and Intel SSR protocols. The serial control port allows read/write access to the AD9508 register map.

In SPI mode, single- or multiple-byte transfers are supported. The SPI port configuration is programmable via Register 0x00. This register is integrated into the SPI control logic rather than in the register map and it is distinct from the I²C Register 0x00.

SPI/I²C PORT SELECTION

The AD9508 has two serial interfaces, SPI and I²C. Users can select either SPI or I²C depending on the state of the PROG_SEL pin. In I²C operation, four different I²C slave address (seven bits wide) settings are available, see Table 16. The five MSBs of the slave address are hardware coded as 11011 and Pin S4 and Pin S5 program the two LSBs.

Table 16. Serial Port Mode Selection

S4	S5	Address
Low	Low	I ² C, 1101100
Low	High	I ² C, 1101101
High	Low	I ² C, 1101110
High	High	I ² C, 1101111

SPI SERIAL PORT OPERATION

Pin Descriptions

The SCLK (serial clock) pin serves as the serial shift clock. This pin is an input. SCLK synchronizes serial control port read and write operations. The rising edge SCLK registers write data bits, and the falling edge registers read data bits. The SCLK pin supports a maximum clock rate of 40 MHz.

The SDIO (serial data input/output) pin is a dual-purpose pin and acts either as an input only (unidirectional mode) or as both an input and an output (bidirectional mode). The AD9508 default SPI mode is bidirectional.

The SDO (serial data output) pin is useful only in unidirectional I/O mode. It serves as the data output pin for read operations.

The CS (chip select) pin is an active low control that gates read and write operations. This pin is internally connected to a 30 k Ω pull-up resistor. When CS is high, the SDO and SDIO pins enter a high impedance state.

SPI Mode Operation

The SPI port supports both 3-wire (bidirectional) and 4-wire (unidirectional) hardware configurations and both MSB first and LSB first data formats. Both the hardware configuration and data format features are programmable. By default, the AD9508 uses the bidirectional MSB first mode. The reason that bidirectional is the default mode is so that the user can continue to write to the device (if it is wired for unidirectional operation) to switch to unidirectional mode.

Assertion (active low) of the CS pin initiates a write or read operation to the AD9508 SPI port. For data transfers of three bytes or fewer (excluding the instruction word), the device supports the CS stalled high mode. In this mode, the CS pin can be temporarily deasserted on any byte boundary, allowing time for the system controller to process the next byte. However, CS can be deasserted on byte boundaries only; this applies to both the instruction and data portions of the transfer.

During stall high periods, the serial control port state machine enters a wait state until all data is sent. If the system controller decides to abort a transfer midstream, the state machine must be reset either by completing the transfer or by asserting the CS pin for at least one complete SCLK cycle (but less than eight SCLK cycles). Deasserting the CS pin on a nonbyte boundary terminates the serial transfer and flushes the buffer.

In streaming mode (see Table 17), any number of data bytes can be transferred in a continuous stream. The register address is automatically incremented or decremented. CS must be deasserted at the end of the last byte that is transferred, thereby ending the stream mode.

Table 17. Byte Transfer Count

W1	W0	Bytes to Transfer
0	0	1
0	1	2
1	0	3
1	1	Streaming mode

Communication Cycle—Instruction Plus Data

The SPI protocol consists of a two part communication cycle. The first part is a 16-bit instruction word that is coincident with the first 16 SCLK rising edges and a payload. The instruction word provides the AD9508 serial control port with information regarding the payload. The instruction word includes the R/W bit that indicates the direction of the payload transfer; that is, a read or write operation. The instruction word also indicates the number of bytes in the payload and the starting register address of the first payload byte.

Write

When the instruction word indicates a write operation, the payload is written into the serial control port buffer of the AD9508. Data bits are registered on the rising edge of SCLK. The length of the transfer (one, two, or three bytes or streaming mode) depends on the W0 and W1 bits in the instruction byte. When not streaming, CS can be deasserted after each sequence of eight bits to stall the bus (except after the last byte, where it ends the cycle). When the bus is stalled, the serial transfer resumes when CS is asserted. Deasserting the CS pin on a nonbyte boundary resets the serial control port. Reserved or blank registers are not skipped automatically during a write sequence. Therefore, the user must know what bit pattern to write to the reserved registers to preserve proper operation of the device. Generally, it does not matter what data is written to blank registers, but it is customary to write 0s.

Read

The AD9508 supports the long instruction mode only. If the instruction word indicates a read operation, the next N × 8 SCLK cycles clock out the data from the address specified in the instruction word. N is the number of data bytes read and depends on the W0 and W1 bits of the instruction word. The readback data is valid on the falling edge of SCLK. Blank registers are not skipped during readback.

A readback operation takes data from either the serial control port buffer registers or the active registers.

SPI Instruction Word (16 Bits)

The MSB of the 16-bit instruction word is R/W, which indicates whether the instruction is a read or a write. The next two bits, W1 and W0, indicate the number of bytes in the transfer. The final 13 bits are the register address (A12 to A0), which indicates the starting register address of the read/write operation (see Table 19).

SPI MSB First and LSB First Transfers

The AD9508 instruction word and payload can be MSB first or LSB first; the default is MSB first. The LSB first mode can be set by writing a 1 to Register 0x00, Bit 6. Immediately after the LSB first bit is set, subsequent serial control port operations are LSB first.

When MSB first mode is active, the instruction and data bytes must be written from MSB to LSB. Multibyte data transfers in MSB first format start with an instruction byte that includes the register address of the most significant payload byte. Subsequent data bytes must follow, in order, from high address to low address. In MSB first mode, the serial control port internal address generator decrements for each data byte of the multibyte transfer cycle.

When Register 0x00, Bit 6 = 1 (LSB first), the instruction and data bytes must be written from LSB to MSB. Multibyte data transfers in LSB first format start with an instruction byte that includes the register address of the least significant payload byte, followed by multiple data bytes. The serial control port internal byte address generator increments for each byte of the multibyte transfer cycle.

For multibyte MSB first (default) I/O operations, the serial control port register address decrements from the specified starting address toward Address 0x00. For multibyte LSB first I/O operations, the serial control port register address increments from the starting address toward Address 0x2C. Reserved addresses are not skipped during multibyte I/O operations; therefore, the user writes the default value to a reserved register and writes 0s to unmapped registers. Note that it is more efficient to issue a new write command than to write the default value to more than two consecutive reserved (or unmapped) registers.

Table 18. Streaming Mode (No Addresses Skipped)

Write Mode	Address Direction	Stop Sequence
LSB First	Increment	0x00 ... 0x2C
MSB First	Decrement	0x2C ... 0x00

Table 19. Serial Control Port, 16-Bit Instruction Word, MSB First Bit Map

MSB													LSB		
I15	I14	I13	I12	I11	I10	I9	I8	I7	I6	I5	I4	I3	I2	I1	I0
R/W	W1	W0	A12	A11	A10	A9	A8	A7	A6	A5	A4	A3	A2	A1	A0

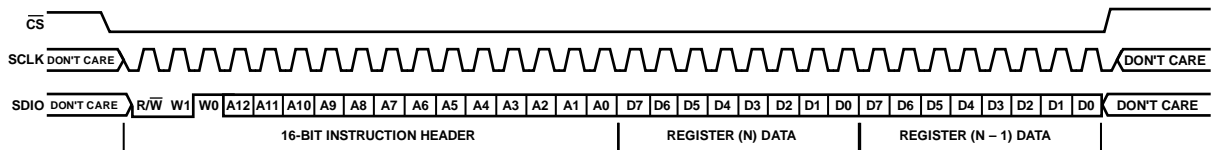

Figure 49. Serial Control Port Write—MSB First, 16-Bit Instruction, Two Bytes of Data

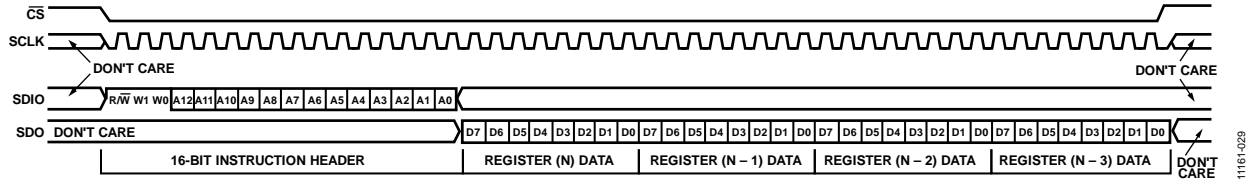

Figure 50. Serial Control Port Read—MSB First, 16-Bit Instruction, Four Bytes of Data

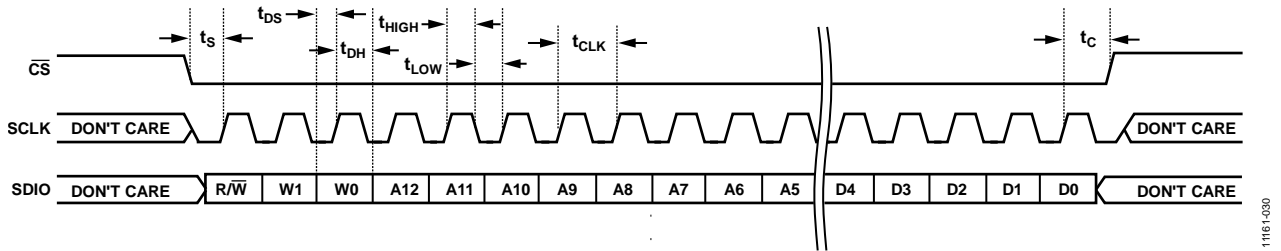

Figure 51. Serial Control Port Write—MSB First, 16-Bit Instruction, Timing Measurements

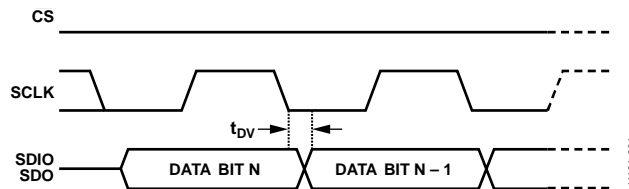

Figure 52. Timing Diagram for Serial Control Port Register Read

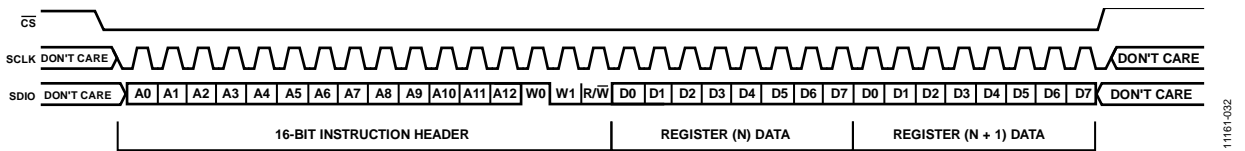

Figure 53. Serial Control Port Write—LSB First, 16-Bit Instruction, Two Bytes of Data

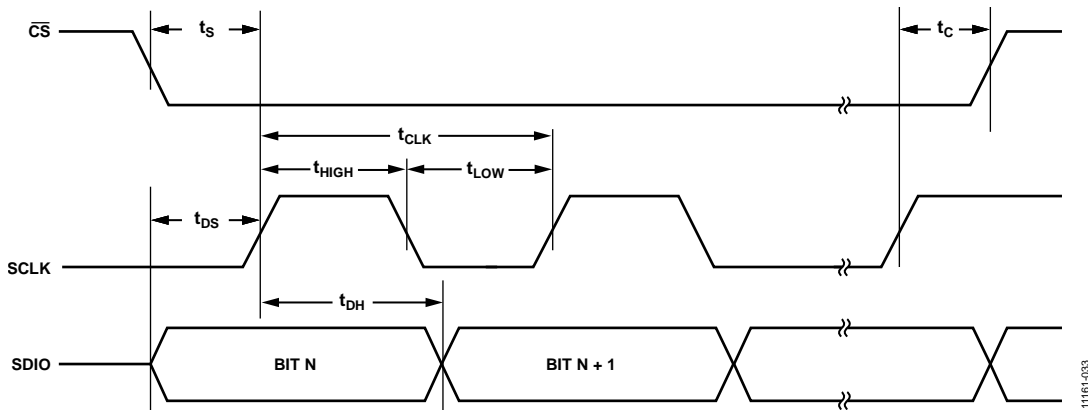

Figure 54. Serial Control Port Timing—Write

Table 20. Serial Control Port Timing

Parameter	Description
t_{DS}	Setup time between data and the rising edge of SCLK
t_{DH}	Hold time between data and the rising edge of SCLK
t_{CLK}	Period of the clock
t_s	Setup time between the \overline{CS} falling edge and the SCLK rising edge (start of the communication cycle)
t_c	Setup time between the SCLK rising edge and \overline{CS} rising edge (end of the communication cycle)
t_{HIGH}	Minimum period that SCLK should be in a logic high state
t_{LOW}	Minimum period that SCLK should be in a logic low state
t_{DV}	SCLK to valid SDIO and SDO (see Figure 52)

I²C SERIAL PORT OPERATION

The I²C interface has the advantage of requiring only two control pins and is a de facto standard throughout the I²C industry. However, its disadvantage is the programming speed, which is 400 kbps maximum. The AD9508 I²C port design is based on the I²C fast mode standard; therefore, it supports both the 100 kHz standard mode and 400 kHz fast mode. Fast mode imposes a glitch tolerance requirement on the control signals; that is, the input receivers ignore pulses of less than 50 ns duration.

The AD9508 I²C port consists of a serial data line (SDA) and a serial clock line (SCL). In an I²C bus system, the AD9508 is connected to the serial bus (data bus SDA and clock bus SCL) as a slave device; that is, no clock is generated by the AD9508. The AD9508 uses direct 16-bit memory addressing rather than traditional 8-bit memory addressing.

The AD9508 allows up to four unique slave devices to occupy the I²C bus. These slave devices are accessed via a 7-bit slave address that is transmitted as part of an I²C packet. Only the device that has a matching slave address responds to subsequent I²C commands. Table 16 lists the supported device slave addresses.

I²C Bus Characteristics

Table 21 provides a summary of the various I²C abbreviations used in the protocol.

Table 21. I²C Bus Abbreviation Definitions

Abbreviation	Definition
S	Start
Sr	Repeated start
P	Stop
ACK	Acknowledge
NACK	No acknowledge
\overline{W}	Write
R	Read

The transfer of data is shown in Figure 55. One clock pulse is generated for each data bit transferred. The data on the SDA line must be stable during the high period of the clock. The high or low state of the data line can change only when the clock signal on the SCL line is low.

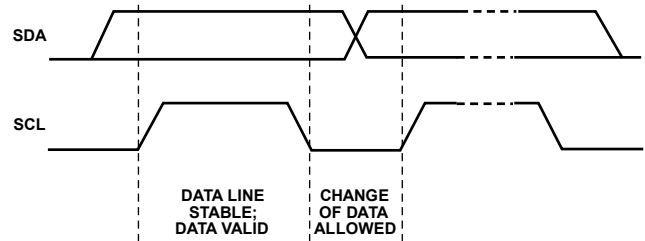

Figure 55. Valid Bit Transfer

Start/stop functionality is shown in Figure 56. The start condition is characterized by a high-to-low transition on the SDA line while SCL is high. The start condition is always generated by the master to initialize a data transfer. The stop condition is characterized by a low-to-high transition on the SDA line while SCL is high. The stop condition is always generated by the master to terminate a data transfer. Every byte on the SDA line must be eight bits long. Each byte must be followed by an acknowledge bit; bytes are sent MSB first.

The acknowledge bit (ACK) is the ninth bit attached to any 8-bit data byte. An acknowledge bit is always generated by the receiving device (receiver) to inform the transmitter that the byte has been received. The acknowledge bit is communicated by pulling the SDA line low during the ninth clock pulse after each 8-bit data byte (see Figure 57).

The no acknowledge bit (NACK) is the ninth bit attached to any 8-bit data byte. The receiving device (receiver) always generates the no acknowledge bit to inform the transmitter that the byte has not been received. The no acknowledge bit is communicated by leaving the SDA line high during the ninth clock pulse after each 8-bit data byte.

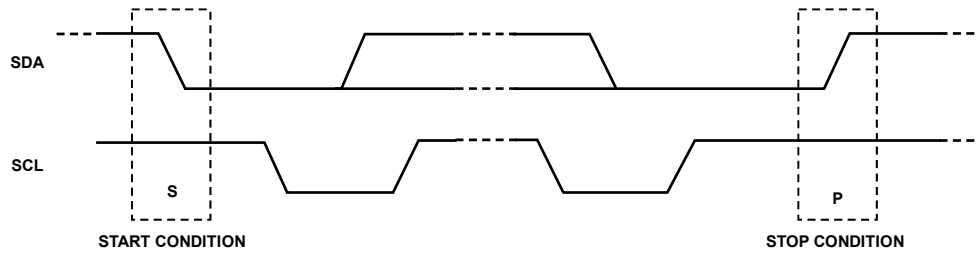

Figure 56. Start and Stop Conditions

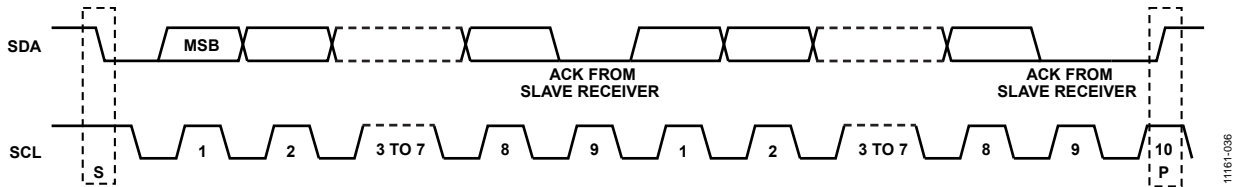

Figure 57. Acknowledge Bit

Data Transfer Process

The master initiates a data transfer by asserting a start condition, which indicates that a data stream follows. All I²C slave devices connected to the serial bus respond to the start condition.

The master then sends an 8-bit address byte over the SDA line, consisting of a 7-bit slave address (MSB first) plus an R/W bit. This bit determines the direction of the data transfer, that is, whether data is written to or read from the slave device (0 = write, 1 = read).

The peripheral whose address corresponds to the transmitted address responds by sending an acknowledge bit. All other devices on the bus remain idle while the selected device waits for data to be read from or written to it. If the R/W bit is 0, the master (transmitter) writes to the slave device (receiver). If the R/W bit is 1, the master (receiver) reads from the slave device (transmitter). The format for these commands is described in the Data Transfer Format section.

Data is then sent over the serial bus in the format of nine clock pulses: one data byte (eight bits) from either master (write mode) or slave (read mode) followed by an acknowledge bit from the receiving device. The number of bytes that can be transmitted per transfer is unrestricted.

In write mode, the first two data bytes immediately after the slave address byte serve as the internal memory (control registers) address bytes, with the high address byte first. This addressing scheme gives a memory address of up to $2^{16} - 1 = 65,535$. The data bytes after these two memory address bytes are register data that are written to or read from the control registers. In read mode, the data bytes after the slave address byte are register data that are written to or read from the control registers.

When all data bytes are read or written, stop conditions are established. In write mode, the master (transmitter) asserts a stop condition to end data transfer during the 10th clock pulse following the acknowledge bit for the last data byte from the slave device (receiver). In read mode, the master device (receiver) receives the last data byte from the slave device (transmitter) but does not pull SDA low during the ninth clock pulse. This condition is known as a no acknowledge bit. By receiving the no acknowledge bit, the slave device knows that the data transfer is finished and enters idle mode. The master then takes the data line low during the low period before the 10th clock pulse and high during the 10th clock pulse to assert a stop condition.

A start condition can be used in place of a stop condition. Furthermore, a start or stop condition can occur at any time, and partially transferred bytes are discarded.

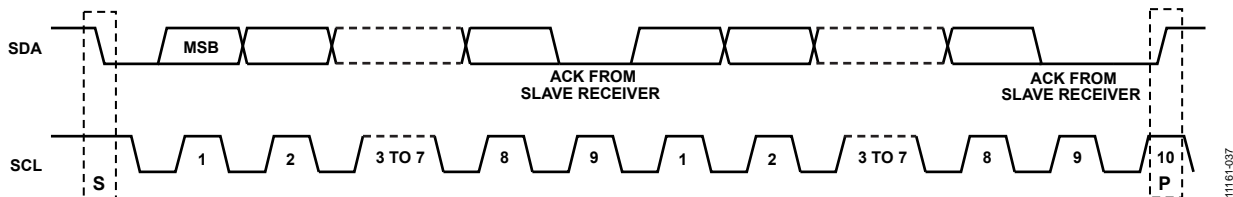

Figure 58. Data Transfer Process (Master Write Mode, Two-Byte Transfer)

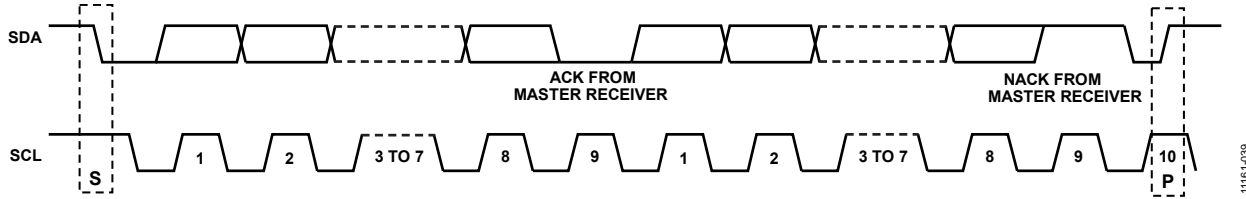

Figure 59. Data Transfer Process (Master Read Mode, Two-Byte Transfer)

Data Transfer Format

Write byte format: The write byte protocol writes a register address to the RAM, starting from the specified RAM address.

S	Slave Address	\overline{W}	A	RAM Address High Byte	A	RAM Address Low Byte	A	RAM Data 0	A	RAM Data 1	A	RAM Data 2	A	P
---	---------------	----------------	---	-----------------------	---	----------------------	---	------------	---	------------	---	------------	---	---

Send byte format: The send byte protocol sets up the register address for subsequent reads.

S	Slave Address	\overline{W}	A	RAM Address High Byte	A	RAM Address Low Byte	A	P
---	---------------	----------------	---	-----------------------	---	----------------------	---	---

Receive byte format: The receive byte protocol reads the data byte(s) from RAM, starting from the current address.

S	Slave Address	R	A	RAM Data 0	A	RAM Data 1	A	RAM Data 2	\overline{A}	P
---	---------------	---	---	------------	---	------------	---	------------	----------------	---

Read byte format: This is the combined format of the send byte and the receive byte.

S	Slave Address	\overline{W}	A	RAM Address High Byte	A	RAM Address Low Byte	A	Sr	Slave Address	R	A	RAM Data 0	A	RAM Data 1	A	RAM Data 2	\overline{A}	P
---	---------------	----------------	---	-----------------------	---	----------------------	---	----	---------------	---	---	------------	---	------------	---	------------	----------------	---

I²C Serial Port Timing

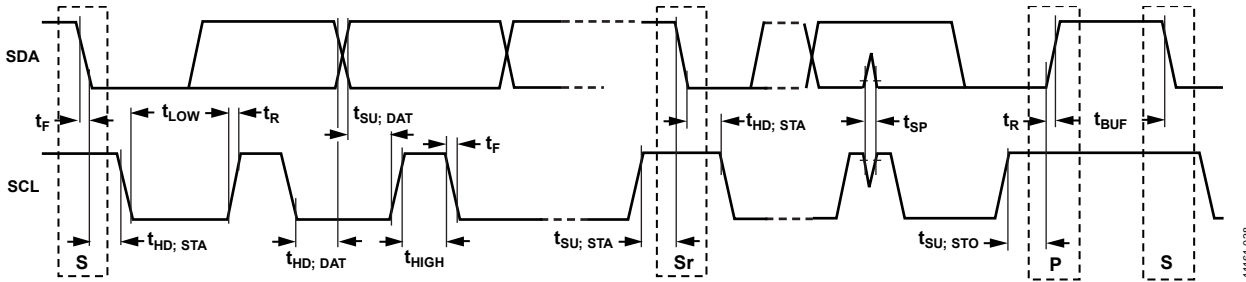

Figure 60. I²C Serial Port Timing

Table 22. I²C Timing Definitions

Parameter	Description
f_{SCL}	Serial clock
t_{BUF}	Bus free time between stop and start conditions
$t_{HD; STA}$	Repeated hold time start condition
$t_{SU; STA}$	Repeated start condition setup time
$t_{SU; STO}$	Stop condition setup time
$t_{HD; DAT}$	Data hold time
$t_{SU; DAT}$	Date setup time
t_{LOW}	SCL clock low period
t_{HIGH}	SCL clock high period
t_R	Minimum/maximum receive SCL and SDA rise time
t_F	Minimum/maximum receive SCL and SDA fall time
t_{SP}	Pulse width of voltage spikes that must be suppressed by the input filter

REGISTER MAP

Register addresses that are not listed in Table 23 are unused, and writing to those registers has no effect. The user should write the default value to sections of registers marked reserved.

The abbreviation, R, in the optional (Opt) column in Table 23 means read only and NS means that the value does not change during a soft reset. Note that the default column is represented by Def.

Table 23. Register Map

Reg Addr (Hex)	Opt	Name	D7	D6	D5	D4	D3	D2	D1	D0	Def	
Serial Control Port Configuration and Part Identification												
0x00	NS	SPI control	SDO enable	LSB first/increment address	Soft reset	Reserved		Soft reset	LSB first/increment address	SDO enable	00	
0x00	NS	I ² C control	Reserved		Soft reset	Reserved		Soft reset	Reserved		00	
0x0A	R, NS	Silicon rev	Silicon Revision[7:0]									00
0x0B	R, NS	Reserved	Reserved									00
0x0C	R, NS	Part ID	Clock Part Family ID[7:0]									05
0x0D	R, NS	Part ID	Clock Part Family ID[15:8]									00
Chip Level Functions												
0x12		Reserved	Reserved									02
0x13		Sleep	Reserved			Sleep	Reserved					00
0x14	NS	SYNC_BAR	Reserved								SYNC_BAR	01
OUT0 Functions												
0x15		OUT0 Divide Ratio[7:0]	Reserved									00
0x16		OUT0 Divide Ratio[9:0]	Reserved						OUT0 Divide Ratio[9:8]			00
0x17		OUT0 Phase[7:0]	Reserved									00
0x18		OUT0 Phase[9:0]	Reserved						OUT0 Phase[10:8]			00
0x19		OUT0 Driver	PD_0	SYNCMASK0	OUT0 Driver Phase[1:0]		OUT0 Mode[2:0]		Reserved		14	
0x1A		OUT0 CMOS	EN_CMOS_0P	CMOS_0P_PHASE[1:0]		EN_CMOS_0N	CMOS_0N_PHASE[1:0]		Reserved		00	
OUT1 Functions												
0x1B		OUT1 Divide Ratio[7:0]	Reserved									00
0x1C		OUT1 Divide Ratio[9:0]	Reserved						OUT1 Divide Ratio[9:8]			00
0x1D		OUT1 Phase[7:0]	Reserved									00
0x1E		OUT1 Phase[9:0]	Reserved						OUT1 Phase[10:8]			00
0x1F		OUT1 Driver	PD_1	SYNCMASK1	OUT1 Driver Phase[1:0]		OUT1 Mode[2:0]		Reserved		14	
0x20		OUT1 CMOS	EN_CMOS_1P	CMOS_1P_PHASE[1:0]		EN_CMOS_1N	CMOS_1N_PHASE[1:0]		Reserved		00	
OUT2 Functions												
0x21		OUT2 Divide Ratio[7:0]	Reserved									00
0x22		OUT2 Divide Ratio[9:0]	Reserved						OUT2 Divide Ratio[9:8]			00
0x23		OUT2 Phase[7:0]	Reserved									00
0x24		OUT2 Phase[9:0]	Reserved						OUT2 Phase[10:8]			00
0x25		OUT2 Driver	PD_2	SYNCMASK2	OUT2 Driver Phase[1:0]		OUT2 Mode[2:0]		Reserved		14	
0x26		OUT2 CMOS	EN_CMOS_2P	CMOS_2P_PHASE[1:0]		EN_CMOS_2N	CMOS_2N_PHASE[1:0]		Reserved		00	
OUT3 Functions												
0x27		OUT3 Divide Ratio[7:0]	Reserved									00
0x28		OUT3 Divide Ratio[9:0]	Reserved						OUT3 Divide Ratio[9:8]			00
0x29		OUT3 Phase[7:0]	Reserved									00
0x2A		OUT3 Phase[9:0]	Reserved						OUT3 Phase[10:8]			00
0x2B		OUT3 Driver	PD_3	SYNCMASK3	OUT3 Driver Phase[1:0]		OUT3 Mode[2:0]		Reserved		14	
0x2C		OUT3 CMOS	EN_CMOS_3P	CMOS_3P_PHASE[1:0]		EN_CMOS_3N	CMOS_3N_PHASE[1:0]		Reserved		00	

REGISTER MAP BIT DESCRIPTIONS

SERIAL PORT CONFIGURATION (REGISTER 0x00)

Table 24. Serial Configuration

Address	Bits	Bit Name	Description
0x00	7	SDO enable	Enables SPI port SDO pin. This bit does nothing in I ² C mode. 1 = 4-wire (SDO pin enabled). 0 = 3-wire (default).
	6	LSB first/increment address	Bit order for the SPI port. This bit is nonfunctional in I ² C mode. 1 = LSB and byte first. Register addresses are automatically incremented in multibyte transfers. 0 = MSB and byte first (default). Register addresses are automatically decremented in multibyte transfers.
	5	Soft reset	Device reset.
	[4:3]	Reserved	Reserved.
	2	Soft reset	Same function as Bit 5 of this register, set Bit 2 and Bit 5 to the same value.
	1	LSB first/increment address	Same function as Bit 6 of this register, set Bit 1 and Bit 6 to the same value.
	0	SDO enable	Same function as Bit 7 of this register, set Bit 7 and Bit 0 to the same value.

SILICON REVISION (REGISTER 0x0A TO REGISTER 0x0D)

Table 25. Silicon Revision

Address	Bits	Bit Name	Description
0x0A	[7:0]	Silicon Revision[7:0]	A read-only register. Identifies the revision level of the AD9508 .
0x0B	[7:0]	Reserved	0x00 = default.
0x0C	[7:0]	Clock Part Family ID[7:0]	A read-only register. This register, together with Register 0x000D, uniquely identifies an AD9508 . No other device in the Analog Devices, Inc., AD95xx family has a value of 0x0005 in these two registers. 0x05 = default.
0x0D	[7:0]	Clock Part Family ID[15:8]	This register is a continuation of Register 0x000C. 0x00 = default.

CHIP LEVEL FUNCTIONS (REGISTER 0x12 TO REGISTER 0x14)

Table 26. Sleep and Synchronization

Address	Bits	Bit Name	Description
0x12	[7:0]	Reserved	0x00000010 = default
0x13	[7:5]	Reserved	0x000 = default
	4	Sleep	0 = disables sleep mode (default) 1 = enables sleep mode
	[3:0]	Reserved	0x0000 = default
0x14	[7:1]	Reserved	0x00000000 = default
	0	SYNC_BAR	0 = enables a software output synchronization routine 1 = output synchronization via software disabled (default)

OUT0 FUNCTIONS (REGISTER 0X15 TO REGISTER 0X1A)

Table 27. Divide Ratio and Phase

Address	Bits	Bit Name	Description
0x15	[7:0]	OUT0 Divide Ratio[7:0]	OUT0 10-bit divider value, Bits[7:0] (LSB). Bits[9:8] (MSB) reside in Register 0x16. Division = OUT0 Divide Ratio, Bits[9:0] + 1. For example, [9:0] = 0 is divide by 1, [9:0] = 1 is divide by 2 ... [9:0] = 1023 is divide by 1024.
0x16	[7:2]	Reserved	0x00 = default
	[1:0]	OUT0 Divide Ratio[9:8]	OUT0 10-bit divider value, Bits[9:8] (MSB). Bits[7:0] (LSB) reside in Register 0x15. Division = OUT0 Divide Ratio, Bits[9:0] + 1. For example, [9:0] = 0 is divide by 1, [9:0] = 1 is divide by 2 ... [9:0] = 1023 is divide by 1024.
0x17	[7:0]	OUT0 Phase[7:0]	OUT0 11-bit phase offset value, Bits[7:0] (LSB). Bits[10:8] (MSB) reside in Register 0x18. Phase Offset = OUT0 Phase, Bits[10:0]. For example, [10:0] = 1 is the minimum phase offset of ½ the input clock period, [10:0] = 2 is a phase offset of one input clock period... [10:0] = 2047 is a phase offset 2047 times ½ the input clock period.
0x18	[7:3]	Reserved	0x00 = default
	[2:0]	OUT0 Phase[10:8]	OUT0 11-bit phase offset value, Bits[10:8] (MSB). Bits[7:0] (LSB) reside in Register 0x17. Phase Offset = OUT0 Phase, Bits[10:0]. For example, [10:0] = 1 is the minimum phase offset of ½ the input clock period, [10:0] = 2 is a phase offset of one input clock period... [10:0] = 2047 is a phase offset 2047 times ½ the input clock period.

Table 28. Output Driver, Power Down, and Sync

Address	Bits	Bit Name	Description
0x19	7	PD_0	Divider 0 power down
	6	SYNCMASK0	Setting this bit masks Divider 0 from the output sync function 0 = Divider 0 is synchronized during output sync (default) 1 = Divider 0 is excluded from an output sync
	[5:4]	OUT0 Driver Phase[1:0]	These bits determine the phase of the OUT0 driver 00 = force high 01 = noninverting (default) 10 = inverting 11 = force low
	[3:1]	OUT0 Mode[2:0]	These bits determine the OUT0 driver mode 000 = LVDS 0.5 × 3.5 mA (1/2 amplitude) 001 = LVDS 0.75 × 3.5 mA (3/4 amplitude) 010 = LVDS 1 × 3.5 mA (default) 011 = LVDS 1.25 × 3.5 mA (1.25 amplitude) 100 = HSTL 1 × 8 mA (normal amplitude) 101 = HSTL boost mode (LVPECL compatible, 40% additional amplitude), approximately 11 mA. 110 = high-Z/CMOS 111 = high-Z/CMOS
	0	Reserved	0b = default
0x1A	7	EN_CMOS_0P	Setting this bit enables the OUT0P CMOS driver 0 = disables the OUT0P CMOS driver (default) 1 = enables the OUT0P CMOS driver
	[6:5]	CMOS_0P_PHASE[1:0]	These bits determine the phase of the OUT0P CMOS driver 00 = force high (default) 01 = noninverting 10 = inverting 11 = force low
	4	EN_CMOS_0N	Setting this bit enables the OUT0N CMOS driver 0 = disables the OUT0N CMOS driver (default) 1 = enables the OUT0N CMOS driver

Address	Bits	Bit Name	Description
	[3:2]	CMOS_ON_PHASE[1:0]	These bits determine the phase of the OUT0N CMOS driver 00 = force high (default) 01 = noninverting 10 = inverting 11 = force low
	[1:0]	Reserved	00b = default

OUT1 FUNCTIONS (REGISTER 0x1B TO REGISTER 0x20)

Table 29. Divide Ratio and Phase

Address	Bits	Bit Name	Description
0x1B	[7:0]	OUT1 Divide Ratio[7:0]	OUT1 10-bit divider value, Bits[7:0] (LSB). Bits[9:8] (MSB) reside in Register 0x1C. Division = OUT1 Divide Ratio, Bits[9:0] + 1. For example, [9:0] = 0 is divide by 1, [9:0] = 1 is divide by 2 ... [9:0] = 1023 is divide by 1024.
0x1C	[7:2]	Reserved	0x00 = default
	[1:0]	OUT1 Divide Ratio[9:8]	OUT1 10-bit divider value, Bits[9:8] (MSB). Bits[7:0] (LSB) reside in Register 0x1B. Division = OUT1 Divide Ratio, Bits[9:0] + 1. For example, [9:0] = 0 is divide by 1, [9:0] = 1 is divide by 2 ... [9:0] = 1023 is divide by 1024.
0x1D	[7:0]	OUT1 Phase[7:0]	OUT1 11-bit phase offset value, Bits[7:0] (LSB). Bits[10:8] (MSB) reside in Register 0x1E. Phase Offset = OUT1 Phase, Bits[10:0]. For example, [10:0] = 1 is the minimum phase offset of ½ the input clock period, [10:0] = 2 is a phase offset of one input clock period... [10:0] = 2047 is a phase offset 2047 times ½ the input clock period.
0x1E	[7:3]	Reserved	0x00 = default
	[2:0]	OUT1 Phase[10:8]	OUT1 11-bit phase offset value, Bits[10:8] (MSB). Bits[7:0] (LSB) reside in Register 0x1D. Phase Offset = OUT1 Phase, Bits[10:0]. For example, [10:0] = 1 is the minimum phase offset of ½ the input clock period, [10:0] = 2 is a phase offset of one input clock period... [10:0] = 2047 is a phase offset 2047 times ½ the input clock period.

Table 30. Output Driver, Power Down, and Sync

Address	Bits	Bit Name	Description
0x1F	7	PD_1	Divider 1 power-down
	6	SYNCMASK1	Setting this bit masks Divider 1 from the output sync function 0 = Divider 1 is synchronized during output sync (default) 1 = Divider 1 is excluded from an output sync
	[5:4]	OUT1 Driver Phase[1:0]	These bits determine the phase of the OUT1 driver 00 = force high 01 = noninverting (default) 10 = inverting 11 = force low
	[3:1]	OUT1 Mode[2:0]	These bits determine the OUT1 driver mode 000 = LVDS 0.5 × 3.5 mA (1/2 amplitude) 001 = LVDS 0.75 × 3.5 mA (3/4 amplitude) 010 = LVDS 1 × 3.5 mA (default) 011 = LVDS 1.25 × 3.5 mA (1.25 amplitude) 100 = HSTL 1 × 8 mA (normal amplitude) 101 = HSTL boost mode (LVPECL compatible, 40% additional amplitude), approximately 11 mA. 110 = high-Z/CMOS 111 = high-Z/CMOS
	0	Reserved	0b = default

Address	Bits	Bit Name	Description
0x20	7	EN_CMOS_1P	Setting this bit enables the OUT1P CMOS driver 0 = disables the OUT1P CMOS driver (default) 1 = enables the OUT1P CMOS driver
	[6:5]	CMOS_1P_PHASE[1:0]	These bits determine the phase of the OUT1P CMOS driver 00 = force high (default) 01 = noninverting 10 = inverting 11 = force low
	[4]	EN_CMOS_1N	Setting this bit enables the OUT1N CMOS driver 0 = disables the OUT1N CMOS driver (default) 1 = enables the OUT1N CMOS driver
	[3:2]	CMOS_1N_PHASE[1:0]	These bits determine the phase of the OUT1N CMOS driver 00 = force high (default) 01 = noninverting 10 = inverting 11 = force low
	[1:0]	Reserved	00b = default

OUT2 FUNCTIONS (REGISTER 0x21 TO REGISTER 0x26)

Table 31. Divide Ratio and Phase

Address	Bits	Bit Name	Description
0x21	[7:0]	OUT2 Divide Ratio[7:0]	OUT2 10-bit divider value, Bits[7:0] (LSB). Bits[9:8] (MSB) reside in Register 0x22. Division = OUT2 Divide Ratio, Bits[9:0] + 1. For example, [9:0] = 0 is divide by 1, [9:0] = 1 is divide by 2 ... [9:0] = 1023 is divide by 1024.
0x22	[7:2]	Reserved	0x00 = default
	[1:0]	OUT2 Divide Ratio[9:8]	OUT2 10-bit divider value, Bits[9:8] (MSB). Bits[7:0] (LSB) reside in Register 0x21. Division = OUT2 Divide Ratio, Bits[9:0] + 1. For example, [9:0] = 0 is divide by 1, [9:0] = 1 is divide by 2 ... [9:0] = 1023 is divide by 1024.
0x23	[7:0]	OUT2 Phase[7:0]	OUT2 11-bit phase offset value, Bits[7:0] (LSB). Bits[10:8] (MSB) reside in Register 0x24. Phase Offset = OUT2 Phase, Bits[10:0]. For example, [10:0] = 1 is the minimum phase offset of ½ the input clock period, [10:0] = 2 is a phase offset of one input clock period... [10:0] = 2047 is a phase offset 2047 times ½ the input clock period.
0x24	[7:3]	Reserved	0x00 = default
	[2:0]	OUT2 Phase[10:8]	OUT2 11-bit phase offset value, Bits[10:8] (MSB). Bits[7:0] (LSB) reside in Register 0x23. Phase Offset = OUT2 Phase, Bits[10:0]. For example, [10:0] = 1 is the minimum phase offset of ½ the input clock period, [10:0] = 2 is a phase offset of one input clock period... [10:0] = 2047 is a phase offset 2047 times ½ the input clock period.

Table 32. Output Driver, Power Down, and Sync

Address	Bits	Bit Name	Description
0x25	7	PD_2	Divider 2 power-down
	6	SYNCMASK2	Setting this bit masks OUT2 from the output sync function 0 = Divider 2 is synchronized during output sync (default) 1 = Divider 2 is excluded from an output sync
	[5:4]	OUT2 Driver Phase[1:0]	These bits determine the phase of the OUT2 driver 00 = force high 01 = noninverting (default) 10 = inverting 11 = force low

Address	Bits	Bit Name	Description
	[3:1]	OUT2 Mode[2:0]	These bits determine the OUT2 driver mode 000 = LVDS 0.5 × 3.5 mA (1/2 amplitude) 001 = LVDS 0.75 × 3.5 mA (3/4 amplitude) 010 = LVDS 1 × 3.5 mA (default) 011 = LVDS 1.25 × 3.5 mA (1.25 amplitude) 100 = HSTL 1 × 8 mA (normal amplitude) 101 = HSTL boost mode (LVPECL compatible, 40% additional amplitude), approximately 11 mA. 110 = high-Z/CMOS 111 = high-Z/CMOS
	0	Reserved	0b = default
0x26	7	EN_CMOS_2P	Setting this bit enables the OUT2P CMOS driver 0 = disables the OUT2P CMOS driver (default) 1 = enables OUT2P CMOS driver
	[6:5]	CMOS_2P_PHASE[1:0]	These bits determine the phase of the OUT2P CMOS driver 00 = force high (default) 01 = noninverting 10 = inverting 11 = force low
	4	EN_CMOS_2N	Setting this bit enables the OUT2N CMOS driver 0 = disables the OUT2N CMOS driver (default) 1 = enables OUT2N CMOS driver
	[3:2]	CMOS_2N_PHASE[1:0]	These bits determine the phase of the OUT2N CMOS driver 00 = force high (default) 01 = noninverting 10 = inverting 11 = force low
	[1:0]	Reserved	00b = default

OUT3 FUNCTIONS (REGISTER 0x27 TO REGISTER 0x2C)

Table 33. Divide Ratio and Phase

Address	Bits	Bit Name	Description
0x27	[7:0]	OUT3 Divide Ratio[7:0]	OUT3 10-bit divider value, Bits[7:0] (LSB). Bits[9:8] (MSB) reside in Register 0x28. Division = OUT3 Divide Ratio, Bits[9:0] + 1. For example, [9:0] = 0 is divide by 1, [9:0] = 1 is divide by 2 ... [9:0] = 1023 is divide by 1024.
0x28	[7:2]	Reserved	0x00 = default
	[1:0]	OUT3 Divide Ratio[9:8]	OUT3 10-bit divider value, Bits[9:8] (MSB). Bits[7:0] (LSB) reside in Register 0x27. Division = OUT3 Divide Ratio, Bits[9:0] + 1. For example, [9:0] = 0 is divide by 1, [9:0] = 1 is divide by 2 ... [9:0] = 1023 is divide by 1024.
0x29	[7:0]	OUT3 Phase[7:0]	OUT3 11-bit phase offset value, Bits[7:0] (LSB). Bits[10:8] (MSB) reside in Register 0x2A. Phase Offset = OUT3 Phase, Bits[10:0]. For example, [10:0] = 1 is the minimum phase offset of ½ the input clock period, [10:0] = 2 is a phase offset of one input clock period... [10:0] = 2047 is a phase offset 2047 times ½ the input clock period
0x2A	[7:3]	Reserved	0x00 = default
	[2:0]	OUT3 Phase[10:8]	OUT3 11-bit phase offset value, Bits[10:8] (MSB). Bits[7:0] (LSB) reside in Register 0x29. Phase Offset = OUT3 Phase, Bits[10:0]. For example, [10:0] = 1 is the minimum phase offset of ½ the input clock period, [10:0] = 2 is a phase offset of one input clock period... [10:0] = 2047 is a phase offset 2047 times ½ the input clock period.

Table 34. Output Driver, Power Down, and Sync

Address	Bits	Bit Name	Description
0x2B	7	PD_3	Divider 3 power-down
	6	SYNCMASK3	Setting this bit masks OUT3 from the output sync function 0 = Divider 3 is synchronized during output sync (default) 1 = Divider 3 is excluded from an output sync
	[5:4]	OUT3 Driver Phase[1:0]	These bits determine the phase of the OUT3 driver 00 = force high 01 = noninverting 10 = inverting 11 = force low
	[3:1]	OUT3 Mode[2:0]	These bits determine the OUT3 driver mode 000 = LVDS 0.5 × 3.5 mA (1/2 amplitude) 001 = LVDS 0.75 × 3.5 mA (3/4 amplitude) 010 = LVDS 1 × 3.5 mA (default) 011 = LVDS 1.25 × 3.5 mA (1.25 amplitude) 100 = HSTL 1 × 8 mA (normal amplitude) 101 = HSTL boost mode (LVPECL compatible, 40% additional amplitude), approximately 11 mA. 110 = high-Z/CMOS 111 = high-Z/CMOS
	0	Reserved	0b = default
0x2C	7	EN_CMOS_3P	Setting this bit enables the OUT3P CMOS driver 0 = disables the OUT3P CMOS driver (default) 1 = enables OUT3P CMOS driver
	[6:5]	CMOS_3P_PHASE[1:0]	These bits determine the phase of the OUT3P CMOS driver 00 = force high (default) 01 = noninverting 10 = inverting 11 = force low
	4	EN_CMOS_3N	Setting this bit enables the OUT3N CMOS driver 0 = disables the OUT3N CMOS driver (default) 1 = enables OUT3N CMOS driver
	[3:2]	CMOS_3N_PHASE[1:0]	These bits determine the phase of the OUT3N CMOS driver 00 = force high (default) 01 = noninverting 10 = inverting 11 = force low
	[1:0]	Reserved	00b = default

PACKAGING AND ORDERING INFORMATION

OUTLINE DIMENSIONS

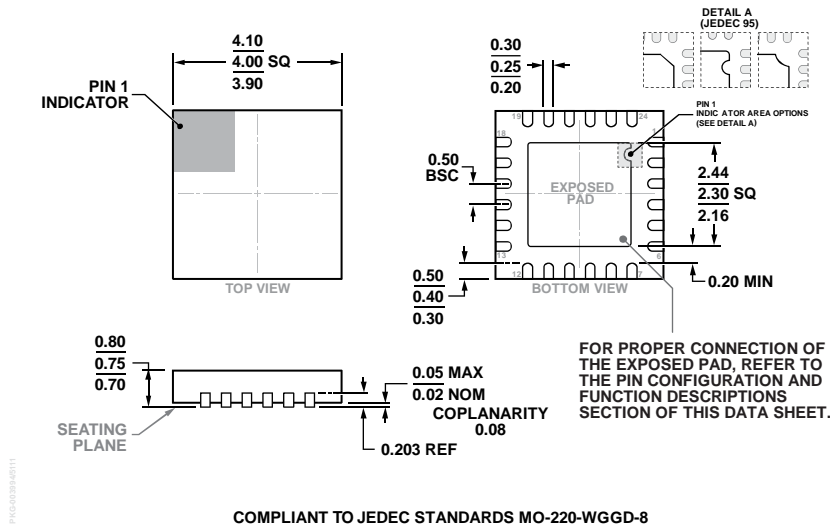

COMPLIANT TO JEDEC STANDARDS MO-220-WGGD-8

Figure 61. 24-Lead Lead Frame Chip Scale Package [LFCS]
 4 mm × 4 mm Body and 0.75 mm Package Height
 (CP-24-14)
 Dimensions shown in millimeters

ORDERING GUIDE

Model ¹	Temperature Range	Package Description	Package Option
AD9508BCPZ	-40°C to +85°C	24-Lead Lead Frame Chip Scale Package [LFCS]	CP-24-14
AD9508BCPZ-REEL7	-40°C to +85°C	24-Lead Lead Frame Chip Scale Package [LFCS]	CP-24-14
AD9508/PCBZ		Evaluation Board	

¹ Z = RoHS Compliant Part.

² I²C refers to a communications protocol originally developed by Philips Semiconductors (now NXP Semiconductors).

X-ON Electronics

Largest Supplier of Electrical and Electronic Components

Click to view similar products for [Clock Drivers & Distribution](#) category:

Click to view products by [Analog Devices](#) manufacturer:

Other Similar products are found below :

[8501BYLF](#) [P9090-0NLGI8](#) [854110AKILF](#) [83210AYLF](#) [NB6VQ572MMNG](#) [HMC6832ALP5LETR](#) [RS232-S5](#) [6ES7390-1AF30-0AA0](#)
[CDCVF2505IDRQ1](#) [LV5609LP-E](#) [NB7L572MNR4G](#) [SY100EP33VKG](#) [HMC7043LP7FETR](#) [ISPPAC-CLK5520V-01T100C](#) [6ES7212-1AF40-0XB0](#) [EC4P-221-MRXD1](#) [6EP1332-1SH71](#) [6ES7222-1BH32-0XB0](#) [AD246JN](#) [AD246JY](#) [AD9510BCPZ](#) [AD9510BCPZ-REEL7](#)
[AD9511BCPZ](#) [AD9511BCPZ-REEL7](#) [AD9512BCPZ](#) [AD9512UCPZ-EP](#) [AD9514BCPZ](#) [AD9514BCPZ-REEL7](#) [AD9515BCPZ-REEL7](#)
[AD9572ACPZLVD](#) [AD9572ACPZPEC](#) [AD9513BCPZ-REEL7](#) [ADCLK950BCPZ](#) [AD9553BCPZ](#) [HMC940LC4B](#) [HMC6832ALP5LE](#)
[CSPUA877ABVG8](#) [9P936AFLFT](#) [49FCT3805ASOG](#) [49FCT3805DQGI](#) [49FCT3805EQGI](#) [49FCT805CTQG](#) [74FCT3807ASOG](#)
[74FCT3807EQGI](#) [74FCT388915TEPYG](#) [853S013AMILF](#) [853S058AGILF](#) [8SLVD1208-33NBGI](#) [8V79S680NLGI](#) [ISPPAC-CLK5312S-01TN48I](#)