

FEATURES

- Supports GR-1244 Stratum 3 stability in holdover mode
- Supports smooth reference switchover with virtually no disturbance on output phase
- Supports Telcordia GR-253 jitter generation, transfer, and tolerance for SONET/SDH up to OC-192 systems
- Supports ITU-T G.8262 synchronous Ethernet slave clocks
- Supports ITU-T G.823, G.824, G.825, and G.8261
- Auto/manual holdover and reference switchover
- Adaptive clocking allows dynamic adjustment of feedback dividers for use in OTN mapping/demapping applications
- Dual digital PLL architecture with four reference inputs (single-ended or differential)
- 4x2 crosspoint allows any reference input to drive either PLL
- Input reference frequencies from 2 kHz to 1250 MHz
- Reference validation and frequency monitoring (2 ppm)
- Programmable input reference switchover priority
- 20-bit programmable input reference divider
- 4 pairs of clock output pins with each pair configurable as a single differential LVDS/HSTL output or as 2 single-ended CMOS outputs
- Output frequencies: 262 kHz to 1250 MHz
- Programmable 17-bit integer and 23-bit fractional feedback divider in digital PLL
- Programmable digital loop filter covering loop bandwidths from 0.1 Hz to 2 kHz
- Low noise system clock multiplier
- Optional crystal resonator for system clock input
- On-chip EEPROM to store multiple power-up profiles

Pin program function for easy frequency translation configuration

Software controlled power-down

72-lead (10 mm × 10 mm) LFCSP package

APPLICATIONS

Network synchronization, including synchronous Ethernet and SDH to OTN mapping/demapping

Cleanup of reference clock jitter

SONET/SDH clocks up to OC-192, including FEC

Stratum 3 holdover, jitter cleanup, and phase transient control

Wireless base station controllers

Cable infrastructure

Data communications

GENERAL DESCRIPTION

The [AD9559](#) is a low loop bandwidth clock multiplier that provides jitter cleanup and synchronization for many systems, including synchronous optical networks (SONET/SDH). The [AD9559](#) generates an output clock synchronized to up to four external input references. The digital PLL allows for reduction of input time jitter or phase noise associated with the external references. The digitally controlled loop and holdover circuitry of the [AD9559](#) continuously generates a low jitter output clock even when all reference inputs have failed.

The [AD9559](#) operates over an industrial temperature range of -40°C to $+85^{\circ}\text{C}$. If a single DPLL version of this part is needed, refer to the [AD9557](#).

FUNCTIONAL BLOCK DIAGRAM

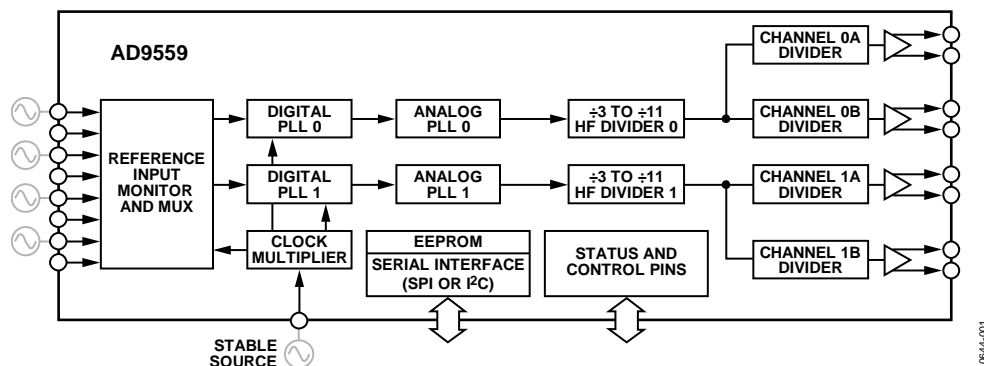

Figure 1.

Rev. C

[Document Feedback](#)

Information furnished by Analog Devices is believed to be accurate and reliable. However, no responsibility is assumed by Analog Devices for its use, nor for any infringements of patents or other rights of third parties that may result from its use. Specifications subject to change without notice. No license is granted by implication or otherwise under any patent or patent rights of Analog Devices. Trademarks and registered trademarks are the property of their respective owners.

One Technology Way, P.O. Box 9106, Norwood, MA 02062-9106, U.S.A.
Tel: 781.329.4700 ©2012–2013 Analog Devices, Inc. All rights reserved.
[Technical Support](#) www.analog.com

TABLE OF CONTENTS

| | | | |
|--|----|---|----|
| Features | 1 | Digital PLL (DPLL) Core | 34 |
| Applications | 1 | Loop Control State Machine | 36 |
| General Description | 1 | System Clock (SYSCLK) | 37 |
| Functional Block Diagram | 1 | SYSCLK Inputs | 37 |
| Revision History | 3 | SYSCLK Multiplier | 37 |
| Specifications | 4 | Output PLL (APLL) | 39 |
| Supply Voltage | 4 | APLL Configuration | 39 |
| Supply Current | 4 | APLL Calibration | 39 |
| Power Dissipation | 5 | Clock Distribution | 40 |
| System Clock Inputs (XOA, XOB) | 5 | Clock Dividers | 40 |
| Reference Inputs | 6 | Output Enable | 40 |
| Reference Monitors | 7 | Output Mode and Power-Down | 40 |
| Reference Switchover Specifications | 7 | Clock Distribution Synchronization | 41 |
| Distribution Clock Outputs | 8 | Status and Control | 42 |
| Time Duration of Digital Functions | 10 | Multifunction Pins (M0 to M5) | 42 |
| Digital PLL (DPLL_0 and DPLL_1) | 10 | IRQ Function | 42 |
| Analog PLL (APLL_0 and APLL_1) | 10 | Watchdog Timer | 43 |
| Digital PLL Lock Detection | 10 | EEPROM | 43 |
| Holdover Specifications | 10 | Serial Control Port | 49 |
| Serial Port Specifications—SPI Mode | 11 | SPI/I ² C Port Selection | 49 |
| Serial Port Specifications—I ² C Mode | 12 | SPI Serial Port Operation | 49 |
| Logic Inputs ($\overline{\text{RESET}}$, M5 to M0) | 12 | I ² C Serial Port Operation | 53 |
| Logic Outputs (M5 to M0) | 12 | Programming the I/O Registers | 56 |
| Jitter Generation | 13 | Buffered/Active Registers | 56 |
| Absolute Maximum Ratings | 16 | Write Detect Registers | 56 |
| ESD Caution | 16 | Autoclear Registers | 56 |
| Pin Configuration and Function Descriptions | 17 | Register Access Restrictions | 56 |
| Typical Performance Characteristics | 20 | Thermal Performance | 57 |
| Input/Output Termination Recommendations | 26 | Power Supply Partitions | 58 |
| Getting Started | 27 | 3.3 V Supplies | 58 |
| Chip Power Monitor and Startup | 27 | 1.8 V Supplies | 58 |
| Multifunction Pins at Reset/Power-Up | 27 | Bypass Capacitors for Pin 21 and Pin 33 | 58 |
| Device Register Programming Using a Register Setup File .. | 27 | Register Map | 59 |
| Register Programming Overview | 28 | Register Map Bit Descriptions | 72 |
| Theory of Operation | 31 | Serial Control Port Configuration (Register 0x0000 to | |
| Overview | 31 | Register 0x0005) | 72 |
| Reference Input Physical Connections | 32 | Clock Part Family ID (Register 0x000C and Register 0x000D) | 72 |
| Reference Monitors | 32 | User Scratchpad (Register 0x000E and Register 0x000F) | 73 |
| Reference Input Block | 32 | General Configuration (Register 0x0100 to Register 0x0109) .. | 73 |
| Reference Switchover | 33 | IRQ Mask (Register 0x010A to Register 0x112) | 74 |

| | | | |
|--|----|--|-----|
| System Clock (Register 0x0200 to Register 0x0207) | 76 | DPLL_1 Settings for Reference Input A (REFA) (Register 0x055A to Register 0x0566)..... | 98 |
| Reference Input A (Register 0x0300 to Register 0x031A) | 77 | DPLL_1 Settings for Reference Input B (REFB) (Register 0x0567 to Register 0x0573)..... | 99 |
| Reference Input B (Register 0x0320 to Register 0x033A)..... | 78 | Digital Loop Filter Coefficients (Register 0x0800 to Register 0x0817) | 100 |
| Reference Input C (Register 0x0340 to Register 0x035A) | 79 | Common Operational Controls (Register 0x0A00 to Register 0x0A0E)..... | 101 |
| Reference Input D (Register 0x0360 to Register 0x037A) | 81 | PLL_0 Operational Controls (Register 0x0A20 to Register 0x0A24) | 104 |
| DPLL_0 Controls (Register 0x0400 to Register 0x0415) | 82 | PLL_1 Operational Controls (Register 0x0A40 to Register 0x0A44) | 106 |
| APLL_0 Configuration (Register 0x0420 to Register 0x0423) .. | 84 | Status ReadBack (Register 0x0D00 to Register 0x0D05)..... | 107 |
| PLL_0 Output Sync and Clock Distribution (Register 0x0424 to Register 0x042E)..... | 85 | IRQ Monitor (Register 0x0D08 to Register 0x0D10) | 108 |
| DPLL_0 Settings for Reference Input A (REFA) (Register 0x0440 to Register 0x044C)..... | 87 | PLL_0 Read-Only Status (Register 0x0D20 to Register 0x0D2A) | 110 |
| DPLL_0 Settings for Reference Input B (REFB) (Register 0x044D to Register 0x0459)..... | 88 | PLL_1 Read-Only Status (Register 0x0D40 to Register 0x0D4A) | 112 |
| DPLL_0 Settings for Reference Input C (REFC) (Register 0x045A to Register 0x0466)..... | 89 | EEPROM Control (Register 0x0E00 to Register 0x0E03) ... | 113 |
| DPLL_0 Settings for Reference Input D (REFD) (Register 0x0467 to Register 0x0473)..... | 90 | EEPROM Storage Sequence (Register 0x0E10 to Register 0x0E3C)..... | 113 |
| DPLL_1 Controls (Register 0x0500 to Register 0x0515)..... | 91 | Outline Dimensions..... | 120 |
| APLL_1 Configuration (Register 0x0520 to Register 0x0523)... | 93 | Ordering Guide | 120 |
| PLL_1 Output Sync and Clock Distribution (Register 0x0524 to Register 0x052E)..... | 94 | | |
| DPLL_1 Settings for Reference Input C (REFC) (Register 0x0540 to Register 0x054C)..... | 96 | | |
| DPLL_1 Settings for Reference Input D (REFD) (Register 0x054D to Register 0x0559)..... | 97 | | |

REVISION HISTORY

5/13—Rev. B to Rev. C

| | |
|---------------------------|----|
| Changes to Table 25 | 49 |
|---------------------------|----|

3/13—Rev. A to Rev. B

| | |
|--|----|
| Changes to Device Register Programming Using a Register Setup File Section | 27 |
| Changed 101100 to 1101100, Table 25 | 49 |

12/12—Rev. 0 to Rev. A

| | |
|--|----|
| Change to Features Section..... | 1 |
| Changes to DPLL Overview Section, Figure 35, and Figure 36..... | 34 |
| Changes to EEPROM Upload Section and Manual EEPROM Download Section..... | 45 |
| Changes to Table 25 | 49 |

| | |
|---|-----|
| Changes to Table 34 | 63 |
| Changes to Table 91 | 87 |
| Changes to Table 92, Table 96, and Table 97 | 88 |
| Changes to Table 101 and Table 102..... | 89 |
| Changes to Table 106 and Table 107..... | 90 |
| Changes to Table 126..... | 97 |
| Changes to Table 127, Table 131, and Table 132..... | 97 |
| Changes to Table 136 and Table 137..... | 98 |
| Changes to Table 141 and Table 142..... | 99 |
| Changes to Table 179 | 113 |
| Updated Outline Dimensions..... | 120 |

7/12—Revision 0: Initial Version

SPECIFICATIONS

Minimum (min) and maximum (max) values apply for the full range of supply voltage and operating temperature variations. Typical (typ) values apply for VDD3 = 3.3 V; VDD = 1.8 V; T_A = 25°C, unless otherwise noted.

SUPPLY VOLTAGE

Table 1.

| Parameter | Min | Typ | Max | Unit | Test Conditions/Comments |
|----------------|-------|------|-------|------|--------------------------|
| SUPPLY VOLTAGE | | | | | |
| VDD3 | 3.135 | 3.30 | 3.465 | V | |
| VDD | 1.71 | 1.80 | 1.89 | V | |

SUPPLY CURRENT

The test conditions for the maximum (max) supply current are at the maximum supply voltage found in Table 1.

The test conditions for the typical (typ) supply current are at the typical supply voltage found in Table 1.

The test conditions for the minimum (min) supply current are at the minimum supply voltage found in Table 1.

Table 2.

| Parameter | Min | Typ | Max | Unit | Test Conditions/Comments |
|---|-----|-----|-----|------|--|
| SUPPLY CURRENT FOR TYPICAL CONFIGURATION | | | | | Typical values are for the Typical Configuration parameter listed in Table 3 |
| I _{VDD3} | 34 | 42 | 50 | mA | |
| I _{VDD} | 253 | 316 | 380 | mA | |
| SUPPLY CURRENT FOR ALL BLOCKS RUNNING CONFIGURATION | | | | | Maximum values are for the All Blocks Running parameter listed in Table 3 |
| I _{VDD3} | 75 | 94 | 113 | mA | |
| I _{VDD} | 256 | 320 | 384 | mA | |

POWER DISSIPATION

Table 3.

| Parameter | Min | Typ | Max | Unit | Test Conditions/Comments |
|------------------------------------|------|------|------|------|---|
| POWER DISSIPATION | | | | | |
| Typical Configuration | 0.57 | 0.71 | 0.85 | W | System clock: 49.152 MHz crystal; two DPLLs active; two 19.44 MHz input references in differential mode; two HSTL drivers at 644.53125 MHz; two 3.3 V CMOS drivers at 161.1328125 MHz and 80 pF capacitive load on CMOS output |
| All Blocks Running | 0.71 | 0.89 | 1.1 | W | System clock: 49.152 MHz crystal; two DPLLs active, all input references in differential mode; two HSTL drivers at 750 MHz; four 3.3 V CMOS drivers at 250 MHz and 80 pF capacitive load on CMOS outputs |
| Full Power-Down | | 75 | 110 | mW | Typical configuration with no external pull-up or pull-down resistors; about 2/3 of this power is on VDD3 |
| Incremental Power Dissipation | | | | | Typical configuration; table values show the change in power due to the indicated operation |
| Complete DPLL/APLL On/Off | 171 | 214 | 257 | mW | This power delta is computed relative to the typical configuration; the blocks powered down include one reference input, one DPLL, one APLL, one P divider, two channel dividers, one HSTL driver, and one CMOS driver; roughly 2/3 of the power savings is on the 1.8 V supply |
| Input Reference On/Off | | | | | |
| Differential Without Divide-by-2 | 19 | 25 | 31 | mW | Additional current draw is in the VDD3 domain only |
| Differential With Divide-by-2 | 25 | 32 | 39 | mW | Additional current draw is in the VDD3 domain only |
| Single-Ended (Without Divide-by-2) | 5 | 6.6 | 8 | mW | Additional current draw is in the VDD3 domain only |
| Output Distribution Driver On/Off | | | | | |
| LVDS (at 750 MHz) | 12 | 17 | 22 | mW | Additional current draw is in the VDD domain only |
| HSTL (at 750 MHz) | 14 | 21 | 28 | mW | Additional current draw is in the VDD domain only |
| 1.8 V CMOS (at 250 MHz) | 14 | 21 | 28 | mW | A single 1.8 V CMOS output with an 80 pF load |
| 3.3 V CMOS (at 250 MHz) | 18 | 27 | 36 | mW | A single 3.3 V CMOS output with an 80 pF load |

SYSTEM CLOCK INPUTS (XOA, XOB)

Table 4.

| Parameter | Min | Typ | Max | Unit | Test Conditions/Comments |
|--|------|------|------|------------|---|
| SYSTEM CLOCK MULTIPLIER | | | | | |
| PLL Output Frequency Range | 750 | | 805 | MHz | VCO range may place limitations on nonstandard system clock input frequencies |
| Phase Frequency Detector (PFD) Rate | | | 150 | MHz | |
| Frequency Multiplication Range | 4 | | 255 | | Assumes valid system clock and PFD rates |
| SYSTEM CLOCK REFERENCE INPUT PATH | | | | | |
| Input Frequency Range | 10 | | 400 | MHz | |
| Minimum Input Slew Rate | 50 | | | V/ μ s | Minimum limit imposed for jitter performance; jitter performance affected if sine wave input \leq 20 MHz |
| Common-Mode Voltage | 1.05 | 1.16 | 1.27 | V | Internally generated |
| Differential Input Voltage Sensitivity | 250 | | | mV p-p | Minimum voltage across pins required to ensure switching between logic states; the instantaneous voltage on either pin must not exceed supply rails; single-ended input can be accommodated by ac grounding complementary input; 1 V p-p recommended for optimal jitter performance |
| System Clock Input Doubler Duty Cycle | | | | | Amount of duty cycle variation that can be tolerated on the system clock input to use the doubler |
| System Clock input = 50 MHz | 45 | 50 | 55 | % | |
| System Clock input = 20 MHz | 46 | 50 | 54 | % | |
| System Clock input = 16 MHz to 20 MHz | 47 | 50 | 53 | % | |
| Input Capacitance | | 3 | | pF | Single-ended, each pin |
| Input Resistance | | 4.1 | | k Ω | |

| Parameter | Min | Typ | Max | Unit | Test Conditions/Comments |
|-------------------------------------|-----|-----|-----|----------|----------------------------------|
| CRYSTAL RESONATOR PATH | | | | | |
| Crystal Resonator Frequency Range | 10 | | 50 | MHz | Fundamental mode, AT cut crystal |
| Maximum Crystal Motional Resistance | | | 100 | Ω | |

REFERENCE INPUTS

Table 5.

| Parameter | Min | Typ | Max | Unit | Test Conditions/Comments |
|--|-------|-----|------|------------|--|
| DIFFERENTIAL OPERATION | | | | | |
| Frequency Range | | | | | The reference input divide-by-2 block must be engaged for $f_{IN} > 705$ MHz |
| Sinusoidal Input | 10 | | 750 | MHz | |
| LVPECL Input | 0.002 | | 1250 | MHz | |
| LVDS Input | 0.002 | | 750 | MHz | |
| Minimum Input Slew Rate | 40 | | | V/ μ s | Minimum limit imposed for jitter performance |
| Common-Mode Input Voltage | | | | | |
| AC-Coupled | 1.9 | 2 | 2.1 | V | Internally generated |
| DC-Coupled | 1.0 | | 2.4 | V | |
| Differential Input Voltage Sensitivity | | | | mV | Minimum differential voltage across pins required to ensure switching between logic levels; instantaneous voltage on either pin must not exceed the supply rails |
| $f_{IN} < 800$ MHz | 240 | | | mV | |
| $f_{IN} = 800$ MHz to 1050 MHz | 320 | | | mV | |
| $f_{IN} = 1050$ MHz to 1250 MHz | 400 | | | mV | |
| Differential Input Voltage Hysteresis | | 55 | 100 | mV | |
| Input Resistance | | 21 | | k Ω | |
| Input Capacitance | | 3 | | pF | |
| Minimum Pulse Width High | | | | | |
| LVPECL | 390 | | | ps | |
| LVDS | 640 | | | ps | |
| Minimum Pulse Width Low | | | | | |
| LVPECL | 390 | | | ps | |
| LVDS | 640 | | | ps | |
| SINGLE-ENDED OPERATION | | | | | |
| Frequency Range (CMOS) | 0.002 | | 300 | MHz | |
| Minimum Input Slew Rate | 40 | | | V/ μ s | Minimum limit imposed for jitter performance |
| Input Voltage High (V_{IH}) | | | | | |
| 1.2 V to 1.5 V Threshold Setting | 1.0 | | | V | |
| 1.8 V to 2.5 V Threshold Setting | 1.4 | | | V | |
| 3.0 V to 3.3 V Threshold Setting | 2.0 | | | V | |
| Input Voltage Low (V_{IL}) | | | | | |
| 1.2 V to 1.5 V Threshold Setting | | | 0.35 | V | |
| 1.8 V to 2.5 V Threshold Setting | | | 0.5 | V | |
| 3.0 V to 3.3 V Threshold Setting | | | 1.0 | V | |
| Input Resistance | | 47 | | k Ω | |
| Input Capacitance | | 3 | | pF | |
| Minimum Pulse Width High | 1.5 | | | ns | |
| Minimum Pulse Width Low | 1.5 | | | ns | |

REFERENCE MONITORS

Table 6.

| Parameter | Min | Typ | Max | Unit | Test Conditions/Comments |
|----------------------------------|-------|-----|--------|--------------------------|---|
| REFERENCE MONITORS | | | | | |
| Reference Monitor | | | | | |
| Loss of Reference Detection Time | | | 1.15 | DPLL PFD period | Nominal phase detector period = R/f_{REF}^1 |
| Frequency Out-of Range Limits | 2 | | 10^5 | $\Delta f/f_{REF}$ (ppm) | Programmable (lower bound subject to quality of the system clock (SYSCLK)); SYSCLK accuracy must be less than the lower bound |
| Validation Timer | 0.001 | | 65.535 | sec | Programmable in 1 ms increments |

¹ f_{REF} is the frequency of the active reference; R is the frequency division factor determined by the R divider.

REFERENCE SWITCHOVER SPECIFICATIONS

Table 7.

| Parameter | Min | Typ | Max | Unit | Test Conditions/Comments |
|---|-----|----------|-----------|-----------------|--|
| REFERENCE SWITCHOVER SPECIFICATIONS | | | | | |
| Maximum Output Phase Perturbation (Phase Build-Out Switchover) | | | | | Assumes a jitter-free reference; satisfies Telcordia GR-1244-CORE requirements; base loop filter selection bit set to 1b for all active references |
| 50 Hz DPLL Loop Bandwidth | | | | | Test conditions: 19.44 MHz to 174.70308 MHz; DPLL BW = 50 Hz; 49.152 MHz signal generator used for system clock source |
| Peak | | ± 55 | ± 100 | ps | |
| Steady State | | ± 55 | ± 100 | ps | |
| Time Required to Switch to a New Reference Phase Build-Out Switchover | | | 10 | DPLL PFD period | Calculated using the nominal phase detector period ($NPDP = R/f_{REF}$); the total time required is the time plus the reference validation time, plus the time required to lock to the new reference |

DISTRIBUTION CLOCK OUTPUTS

Table 8.

| Parameter | Min | Typ | Max | Unit | Test Conditions/Comments |
|---|-------|-------|-------|------------------------|--|
| HSTL MODE | | | | | |
| Output Frequency | | | | | |
| OUT0A, $\overline{\text{OUT0A}}$ and OUT0B, $\overline{\text{OUT0B}}$ | 0.262 | | 1250 | MHz | |
| OUT1A, $\overline{\text{OUT1A}}$ and OUT1B, $\overline{\text{OUT1B}}$ | 0.302 | | 1250 | MHz | |
| Rise/Fall Time (20% to 80%) ¹ | | 140 | 250 | ps | 100 Ω termination across the output pair |
| Duty Cycle | | | | | |
| Up to $f_{\text{OUT}} = 700$ MHz | 44 | 48 | 53 | % | |
| Up to $f_{\text{OUT}} = 750$ MHz | 43 | 48 | 54 | % | |
| Up to $f_{\text{OUT}} = 1250$ MHz | | 43 | | % | |
| Differential Output Voltage Swing | 700 | 925 | 1200 | mV | Magnitude of voltage across pins; output driver static |
| Common-Mode Output Voltage | 750 | 850 | 1000 | mV | Output driver static |
| Reference Input-to-Output Delay Variation over Temperature | | 3.2 | | ps/ $^{\circ}\text{C}$ | HSTL mode; DPLL locked to same input reference at all times; stable system clock source (non-XTAL) |
| Static Phase Offset Variation from Active Reference to Output over Voltage Extremes | | 0.875 | | ps/mV | Valid for HSTL, LVDS, and 1.8 V CMOS output driver modes |
| LVDS MODE | | | | | |
| Output Frequency | | | | | |
| OUT0A, $\overline{\text{OUT0A}}$ and OUT0B, $\overline{\text{OUT0B}}$ | 0.262 | | 1250 | MHz | |
| OUT1A, $\overline{\text{OUT1A}}$ and OUT1B, $\overline{\text{OUT1B}}$ | 0.302 | | 1250 | MHz | |
| Rise/Fall Time (20% to 80%) ¹ | | 185 | 280 | ps | 100 Ω termination across the output pair |
| Duty Cycle | | | | | |
| Up to $f_{\text{OUT}} = 750$ MHz | 43 | 48 | 53 | % | |
| Up to $f_{\text{OUT}} = 800$ MHz | 42.5 | 48 | 53.5 | % | |
| Up to $f_{\text{OUT}} = 1250$ MHz | | 43 | | % | |
| Differential Output Voltage Swing | | | | | |
| Balanced, V_{OD} | 247 | | 454 | mV | Voltage swing between output pins; output driver static |
| Unbalanced, ΔV_{OD} | | | 50 | mV | Absolute difference between voltage swing of normal pin and inverted pin; output driver static |
| Offset Voltage | | | | | |
| Common Mode, V_{OS} | 1.125 | 1.25 | 1.375 | V | Output driver static |
| Common-Mode Difference, ΔV_{OS} | | | 50 | mV | Voltage difference between pins; output driver static |
| Short-Circuit Output Current | | 10 | 24 | mA | Output driver static |
| CMOS MODE | | | | | |
| Output Frequency | | | | | |
| 1.8 V Supply | | | | | |
| OUT0A, $\overline{\text{OUT0A}}$ and OUT0B, $\overline{\text{OUT0B}}$ | 0.262 | | 250 | MHz | 10 pF load |
| OUT1A, $\overline{\text{OUT1A}}$ and OUT1B, $\overline{\text{OUT1B}}$ | 0.302 | | 250 | MHz | 10 pF load |
| 3.3 V Supply (OUT0A and OUT1A) | | | | | |
| Strong Drive Strength Setting | | | | | |
| OUT0A, $\overline{\text{OUT0A}}$ | 0.262 | | 250 | MHz | 10 pF load |
| OUT1A, $\overline{\text{OUT1A}}$ | 0.302 | | 250 | MHz | 10 pF load |
| Weak Drive Strength Setting | | | | | |
| OUT0A, $\overline{\text{OUT0A}}$ | 0.262 | | 25 | MHz | 10 pF load |
| OUT1A, $\overline{\text{OUT1A}}$ | 0.302 | | 25 | MHz | 10 pF load |

| Parameter | Min | Typ | Max | Unit | Test Conditions/Comments |
|---|------------|------|------|------|--|
| Rise/Fall Time (20% to 80%) ¹ | | | | | |
| 1.8 V Mode | | 1.5 | 3 | ns | 10 pF load |
| 3.3 V Strong Mode | | 0.4 | 0.6 | ns | 10 pF load |
| 3.3 V Weak Mode | | 8 | | ns | 10 pF load |
| Duty Cycle | | | | | |
| 1.8 V Mode | | 50 | | % | 10 pF load |
| 3.3 V Strong Mode | 47 | 51 | 56 | % | 10 pF load |
| 3.3 V Weak Mode | | 51 | | % | 10 pF load |
| Output Voltage High (V_{OH}) | | | | | Output driver static; strong drive strength |
| VDD3 = 3.3 V, I_{OH} = 10 mA | VDD3 – 0.3 | | | V | |
| VDD3 = 3.3 V, I_{OH} = 1 mA | VDD3 – 0.1 | | | V | |
| VDD3 = 1.8 V, I_{OH} = 1 mA | VDD – 0.2 | | | V | |
| Output Voltage Low (V_{OL}) | | | | | Output driver static; strong drive strength |
| VDD3 = 3.3 V, I_{OL} = 10 mA | | | 0.3 | V | |
| VDD3 = 3.3 V, I_{OL} = 1 mA | | | 0.1 | V | |
| VDD3 = 1.8 V, I_{OL} = 1 mA | | | 0.1 | V | |
| OUTPUT TIMING SKEW | | | | | 10 pF load |
| Between $\overline{OUT0A}$, $\overline{OUT0A}$ and $\overline{OUT0B}$, $\overline{OUT0B}$ or $\overline{OUT1A}$, $\overline{OUT1A}$ and $\overline{OUT1B}$, $\overline{OUT1B}$ | | 116 | 265 | ps | HSTL mode on both drivers; rising edge only; any divide value |
| Additional Delay on One Driver by Changing Its Logic Type | | | | | |
| HSTL to LVDS | 0 | +15 | +35 | ps | Positive value indicates that the LVDS edge is delayed relative to HSTL |
| HSTL to 1.8 V CMOS | -5 | 0 | +5 | ps | Positive value indicates that the CMOS edge is delayed relative to HSTL |
| $\overline{OUT0B}$, $\overline{OUT0B}$ HSTL to $\overline{OUT0B}$, $\overline{OUT0B}$ 3.3 V CMOS, Strong Mode | -765 | -280 | +250 | ns | The CMOS edge is delayed relative to HSTL |
| $\overline{OUT1B}$, $\overline{OUT1B}$ HSTL to $\overline{OUT1B}$, $\overline{OUT1B}$ 3.3 V CMOS, Strong Mode | -765 | -280 | +250 | ns | The CMOS edge is delayed relative to HSTL |

¹ The listed values are for the slower edge (rising or falling).

TIME DURATION OF DIGITAL FUNCTIONS

Table 9.

| Parameter | Min | Typ | Max | Unit | Test Conditions/Comments |
|------------------------------------|-----|-----|-----|------|--|
| TIME DURATION OF DIGITAL FUNCTIONS | | | | | |
| EEPROM-to-Register Download Time | | 16 | 25 | ms | Uses default EEPROM storage sequence (see Register 0x0E10 to Register 0x0E4F) |
| Register-to-EEPROM Upload Time | | | 180 | ms | Uses default EEPROM storage sequence (see Register 0x0E10 to Register 0x0E4F) |
| Power-Down Exit Time | | 1 | | ms | Time from power-down exit to system clock lock detect; system clock stability timer setting should be added to calculate the time needed for system clock stable |

DIGITAL PLL (DPLL_0 AND DPLL_1)

Table 10.

| Parameter | Min | Typ | Max | Unit | Test Conditions/Comments |
|--|------|-----|------|---------|--|
| DIGITAL PLL | | | | | |
| Phase Frequency Detector (PFD) Input Frequency Range | 2 | | 100 | kHz | |
| Loop Bandwidth | 0.1 | | 2000 | Hz | Programmable design parameter; note that $(f_{PFD}/\text{loop BW}) \geq 20$ |
| Phase Margin | 45 | | 89 | Degrees | Programmable design parameter |
| Closed Loop Peaking | <0.1 | | | dB | Programmable design parameter; part can be programmed for <0.1 dB peaking in accordance with Telcordia GR-253-CORE jitter transfer |

ANALOG PLL (APLL_0 AND APLL_1)

Table 11.

| Parameter | Min | Typ | Max | Unit | Test Conditions/Comments |
|--|------|-----|------|---------|-------------------------------|
| ANALOG PLL0 | | | | | |
| VCO Frequency Range | 2940 | | 3543 | MHz | |
| Phase Frequency Detector (PFD) Input Frequency Range | | 180 | 195 | MHz | |
| Loop Bandwidth | | 240 | | kHz | Programmable design parameter |
| Phase Margin | | 68 | | Degrees | Programmable design parameter |
| ANALOG PLL1 | | | | | |
| VCO Frequency Range | 3405 | | 4260 | MHz | |
| Phase Frequency Detector (PFD) Input Frequency Range | | 180 | 195 | MHz | |
| Loop Bandwidth | | 240 | | kHz | Programmable design parameter |
| Phase Margin | | 68 | | Degrees | Programmable design parameter |

DIGITAL PLL LOCK DETECTION

Table 12.

| Parameter | Min | Typ | Max | Unit | Test Conditions/Comments |
|-----------------------------|-----|-----|--------------|------|---|
| PHASE LOCK DETECTOR | | | | | |
| Threshold Programming Range | 10 | | $2^{24} - 1$ | ps | Reference-to-feedback phase difference |
| Threshold Resolution | | 1 | | ps | |
| FREQUENCY LOCK DETECTOR | | | | | |
| Threshold Programming Range | 10 | | $2^{24} - 1$ | ps | Reference-to-feedback period difference |
| Threshold Resolution | | 1 | | ps | |

HOLD OVER SPECIFICATIONS

Table 13.

| Parameter | Min | Typ | Max | Unit | Test Conditions/Comments |
|----------------------------|-----|-------|-----|------|---|
| HOLD OVER SPECIFICATIONS | | | | | |
| Initial Frequency Accuracy | | <0.01 | | ppm | Excludes frequency drift of SYSCLK source; excludes frequency drift of input reference prior to entering holdover; compliant with GR-1244 Stratum 3 |

SERIAL PORT SPECIFICATIONS—SPI MODE

Table 14.

| Parameter | Min | Typ | Max | Unit | Test Conditions/Comments |
|---|------------|-----|-----|---------------|---|
| M5/ $\overline{\text{CS}}$ | | | | | M5/ $\overline{\text{CS}}$ is a dual function pin; the values in this table apply when this pin is used as a serial port pin, that is, $\overline{\text{CS}}$; see Table 16 for the specifications when this pin is used as a multifunction pin (M5) |
| Input Logic 1 Voltage | 2.2 | | | V | |
| Input Logic 0 Voltage | | | 0.8 | V | |
| Input Logic 1 Current | | 20 | | μA | |
| Input Logic 0 Current | | 50 | | μA | |
| Input Capacitance | | 2 | | pF | |
| SCLK | | | | | Internal 10 k Ω pull-down resistor |
| Input Logic 1 Voltage | 2.2 | | | V | |
| Input Logic 0 Voltage | | | 0.8 | V | |
| Input Logic 1 Current | | 200 | | μA | |
| Input Logic 0 Current | | 1 | | μA | |
| Input Capacitance | | 2 | | pF | |
| SDIO | | | | | |
| As an Input | | | | | |
| Input Logic 1 Voltage | 2.2 | | | V | |
| Input Logic 0 Voltage | | | 0.8 | V | |
| Input Logic 1 Current | | 1 | | μA | |
| Input Logic 0 Current | | 1 | | μA | |
| Input Capacitance | | 2 | | pF | |
| As an Output | | | | | |
| Output Logic 1 Voltage | VDD3 – 0.6 | | | V | 1 mA load current |
| Output Logic 0 Voltage | | | 0.4 | V | 1 mA load current |
| M4/SDO | | | | | M4/SDO is a dual function pin; the values in this table apply when this pin is used as a serial port pin, that is SDO; see Table 16 for the specifications when this pin is used as a multifunction pin (M4) |
| Output Logic 1 Voltage | VDD3 – 0.6 | | | V | 1 mA load current |
| Output Logic 0 Voltage | | | 0.4 | V | 1 mA load current |
| TIMING | | | | | See Figure 47 and Figure 50 |
| SCLK | | | | | |
| Clock Rate, 1/ t_{CLK} | | | 40 | MHz | |
| Pulse Width High, t_{HIGH} | 10 | | | ns | |
| Pulse Width Low, t_{LOW} | 13 | | | ns | |
| SDIO to SCLK Setup, t_{DS} | 3 | | | ns | |
| SCLK to SDIO Hold, t_{DH} | 6 | | | ns | |
| SCLK to Valid SDIO and SDO, t_{DV} | | | 10 | ns | |
| $\overline{\text{CS}}$ to SCLK Setup (t_{s}) | 10 | | | ns | |
| $\overline{\text{CS}}$ to SCLK Hold (t_{c}) | 0 | | | ns | |
| $\overline{\text{CS}}$ Minimum Pulse Width High | 6 | | | ns | |

SERIAL PORT SPECIFICATIONS—I²C MODE

Table 15.

| Parameter | Min | Typ | Max | Unit | Test Conditions/Comments |
|---|---------------------|-----|-------------------|---------|---|
| SDA, SCL (AS INPUTS) | | | | | |
| Input Logic 1 Voltage | $0.7 \times VDD3$ | | | V | For $V_{IN} = 10\%$ to 90% of $VDD3$ |
| Input Logic 0 Voltage | | | $0.3 \times VDD3$ | V | |
| Input Current | -10 | | +10 | μA | |
| Hysteresis of Schmitt Trigger Inputs | $0.015 \times VDD3$ | | | | |
| Pulse Width of Spikes That Must Be Suppressed by the Input Filter, t_{SP} | | | 50 | ns | |
| SDA (AS OUTPUT) | | | | | |
| Output Logic 0 Voltage | | | 0.4 | V | $I_O = 3 \text{ mA}$ |
| Output Fall Time from V_{IHmin} to V_{ILmax} | $20 + 0.1 C_b^1$ | | 250 | ns | $10 \text{ pF} \leq C_b \leq 400 \text{ pF}$ |
| TIMING | | | | | |
| SCL Clock Rate | | | 400 | kHz | After this period, the first clock pulse is generated |
| Bus-Free Time Between a Stop and Start Condition, t_{BUF} | 1.3 | | | μs | |
| Repeated Start Condition Setup Time, $t_{SU,STA}$ | 0.6 | | | μs | |
| Repeated Hold Time Start Condition, $t_{HD,STA}$ | 0.6 | | | μs | |
| Stop Condition Setup Time, $t_{SU,STO}$ | 0.6 | | | μs | |
| Low Period of the SCL Clock, t_{LOW} | 1.3 | | | μs | |
| High Period of the SCL Clock, t_{HIGH} | 0.6 | | | μs | |
| SCL/SDA Rise Time, t_r | $20 + 0.1 C_b^1$ | | 300 | ns | |
| SCL/SDA Fall Time, t_f | $20 + 0.1 C_b^1$ | | 300 | ns | |
| Data Setup Time, $t_{SU,DAT}$ | 100 | | | ns | |
| Data Hold Time, $t_{HD,DAT}$ | 100 | | | ns | |
| Capacitive Load for Each Bus Line, C_b^1 | | | 400 | pF | |

¹ C_b is the capacitance (pF) of a single bus line.

LOGIC INPUTS ($\overline{\text{RESET}}$, M5 TO M0)

Table 16.

| Parameter | Min | Typ | Max | Unit | Test Conditions/Comments |
|---|-----|----------|-----------|---------|---|
| $\overline{\text{RESET}}$ PIN | | | | | |
| Input High Voltage (V_{IH}) | 2.1 | | | V | |
| Input Low Voltage (V_{IL}) | | | 0.8 | V | |
| Input Current (I_{INH} , I_{INL}) | | ± 85 | ± 125 | μA | |
| Input Capacitance (C_{IN}) | | 3 | | pF | |
| LOGIC INPUTS (M5 to M0) | | | | | |
| Input High Voltage (V_{IH}) | 2.5 | | | V | The M4 and M5 pins are dual function pins; the values in this table apply when M4/SDO and M5/ \overline{CS} are used as M pins; see Table 14 in the Serial Port Specifications—SPI Mode section for the specifications when these pins are used as serial port pins (SDO, \overline{CS}) |
| Input Low Voltage (V_{IL}) | | | 0.6 | V | |
| Input Current (I_{INH} , I_{INL}) | | ± 1 | ± 5 | μA | |
| Input Capacitance (C_{IN}) | | 3 | | pF | |

LOGIC OUTPUTS (M5 TO M0)

Table 17.

| Parameter | Min | Typ | Max | Unit | Test Conditions/Comments |
|----------------------------------|--------------|-----|-----|------|--------------------------|
| LOGIC OUTPUTS (M5 to M0) | | | | | |
| Output High Voltage (V_{OH}) | $VDD3 - 0.4$ | | | V | $I_{OH} = 1 \text{ mA}$ |
| Output Low Voltage (V_{OL}) | | | 0.4 | V | $I_{OL} = 1 \text{ mA}$ |

JITTER GENERATION**Jitter Generation (Random Jitter)—49.152 MHz Crystal for System Clock Input**

Table 18.

| Parameter | Min | Typ | Max | Unit | Test Conditions/Comments |
|---|-----|-----|-----|--------|--|
| JITTER GENERATION | | | | | System clock doubler enabled. High phase margin mode enabled. Both PLLs are running with same output frequency. In cases where the two PLLs have different jitter, the higher jitter is listed. When two driver types are listed, both were tested at those conditions; the driver type with higher jitter is quoted, although there is usually not a significant jitter difference between driver types. |
| $f_{REF} = 19.44 \text{ MHz}; f_{OUT} = 622.08 \text{ MHz}; f_{LOOP} = 50 \text{ Hz};$ HSTL Driver | | | | | |
| Bandwidth: 5 kHz to 20 MHz | | 307 | | fs rms | |
| Bandwidth: 12 kHz to 20 MHz | | 310 | | fs rms | |
| Bandwidth: 20 kHz to 80 MHz | | 313 | | fs rms | |
| Bandwidth: 50 kHz to 80 MHz | | 292 | | fs rms | |
| Bandwidth: 16 MHz to 320 MHz | | 149 | | fs rms | |
| $f_{REF} = 19.44 \text{ MHz}; f_{OUT} = 644.53 \text{ MHz}; f_{LOOP} = 50 \text{ Hz};$ HSTL Driver, LVDS Driver | | | | | |
| Bandwidth: 5 kHz to 20 MHz | | 313 | | fs rms | |
| Bandwidth: 12 kHz to 20 MHz | | 306 | | fs rms | |
| Bandwidth: 20 kHz to 80 MHz | | 308 | | fs rms | |
| Bandwidth: 50 kHz to 80 MHz | | 286 | | fs rms | |
| Bandwidth: 16 MHz to 320 MHz | | 154 | | fs rms | |
| $f_{REF} = 19.44 \text{ MHz}; f_{OUT} = 693.48 \text{ MHz}; f_{LOOP} = 50 \text{ Hz};$ HSTL Driver | | | | | |
| Bandwidth: 5 kHz to 20 MHz | | 335 | | fs rms | |
| Bandwidth: 12 kHz to 20 MHz | | 328 | | fs rms | |
| Bandwidth: 20 kHz to 80 MHz | | 328 | | fs rms | |
| Bandwidth: 50 kHz to 80 MHz | | 298 | | fs rms | |
| Bandwidth: 16 MHz to 320 MHz | | 150 | | fs rms | |
| $f_{REF} = 19.44 \text{ MHz}; f_{OUT} = 174.703 \text{ MHz}; f_{LOOP} = 1 \text{ kHz};$ HSTL Driver | | | | | |
| Bandwidth: 5 kHz to 20 MHz | | 396 | | fs rms | |
| Bandwidth: 12 kHz to 20 MHz | | 335 | | fs rms | |
| Bandwidth: 20 kHz to 80 MHz | | 369 | | fs rms | |
| Bandwidth: 50 kHz to 80 MHz | | 347 | | fs rms | |
| Bandwidth: 4 MHz to 80 MHz | | 230 | | fs rms | |
| $f_{REF} = 19.44 \text{ MHz}; f_{OUT} = 174.703 \text{ MHz}; f_{LOOP} = 100 \text{ Hz};$ LVDS Driver, 3.3 V CMOS Driver | | | | | |
| Bandwidth: 5 kHz to 20 MHz | | 337 | | fs rms | |
| Bandwidth: 12 kHz to 20 MHz | | 330 | | fs rms | |
| Bandwidth: 20 kHz to 80 MHz | | 354 | | fs rms | |
| Bandwidth: 50 kHz to 80 MHz | | 339 | | fs rms | |
| Bandwidth: 4 MHz to 80 MHz | | 220 | | fs rms | |
| $f_{REF} = 25 \text{ MHz}; f_{OUT} = 161.1328 \text{ MHz}; f_{LOOP} = 100 \text{ Hz};$ HSTL Driver | | | | | |
| Bandwidth: 5 kHz to 20 MHz | | 318 | | fs rms | |
| Bandwidth: 12 kHz to 20 MHz | | 310 | | fs rms | |
| Bandwidth: 20 kHz to 80 MHz | | 384 | | fs rms | |
| Bandwidth: 50 kHz to 80 MHz | | 361 | | fs rms | |
| Bandwidth: 4 MHz to 80 MHz | | 267 | | fs rms | |

| Parameter | Min | Typ | Max | Unit | Test Conditions/Comments |
|---|-----|-----|-----|--------|--------------------------|
| $f_{REF} = 2 \text{ kHz}$; $f_{OUT} = 70.656 \text{ MHz}$; $f_{LOOP} = 100 \text{ Hz}$; HSTL Driver, 3.3 V CMOS Driver | | | | | |
| Bandwidth: 10Hz to 30 MHz | | 6.5 | | ps rms | |
| Bandwidth: 5 kHz to 20 MHz | | 343 | | fs rms | |
| Bandwidth: 12 kHz to 20 MHz | | 335 | | fs rms | |
| Bandwidth: 10 kHz to 400 kHz | | 243 | | fs rms | |
| Bandwidth: 100 kHz to 10 MHz | | 256 | | fs rms | |
| $f_{REF} = 25 \text{ MHz}$; $f_{OUT} = 1 \text{ GHz}$; $f_{LOOP} = 500 \text{ Hz}$; HSTL Driver | | | | | |
| Bandwidth: 100 Hz to 500 MHz (Broadband) | | 881 | | fs rms | |
| Bandwidth: 12 kHz to 20 MHz | | 331 | | fs rms | |
| Bandwidth: 20 kHz to 80 MHz | | 330 | | fs rms | |

Jitter Generation (Random Jitter)—19.2 MHz TCXO for System Clock Input

Table 19.

| Parameter | Min | Typ | Max | Unit | Test Conditions/Comments |
|--|-----|-----|-----|--------|---|
| JITTER GENERATION | | | | | System clock doubler enabled. High phase margin mode enabled. Both PLLs are running with same output frequency. In cases where the two PLLs have different jitter, the higher jitter is listed. Where two driver types are listed, both were tested at those conditions; the driver type with higher jitter is quoted, although there is usually not a significant jitter difference between driver types. |
| $f_{REF} = 19.44 \text{ MHz}$; $f_{OUT} = 644.53 \text{ MHz}$; $f_{LOOP} = 10 \text{ Hz}$; HSTL Driver | | | | | |
| Bandwidth: 5 kHz to 20 MHz | | 380 | | fs rms | |
| Bandwidth: 12 kHz to 20 MHz | | 373 | | fs rms | |
| Bandwidth: 20 kHz to 80 MHz | | 373 | | fs rms | |
| Bandwidth: 50 kHz to 80 MHz | | 348 | | fs rms | |
| Bandwidth: 16 MHz to 320 MHz | | 148 | | fs rms | |
| $f_{REF} = 19.44 \text{ MHz}$; $f_{OUT} = 693.48 \text{ MHz}$; $f_{LOOP} = 10 \text{ Hz}$; HSTL Driver | | | | | |
| Bandwidth: 5 kHz to 20 MHz | | 390 | | fs rms | |
| Bandwidth: 12 kHz to 20 MHz | | 383 | | fs rms | |
| Bandwidth: 20 kHz to 80 MHz | | 382 | | fs rms | |
| Bandwidth: 50 kHz to 80 MHz | | 350 | | fs rms | |
| Bandwidth: 16 MHz to 320 MHz | | 144 | | fs rms | |
| $f_{REF} = 19.44 \text{ MHz}$; $f_{OUT} = 312.5 \text{ MHz}$; $f_{LOOP} = 10 \text{ Hz}$; HSTL Driver | | | | | |
| Bandwidth: 5 kHz to 20 MHz | | 398 | | fs rms | |
| Bandwidth: 12 kHz to 20 MHz | | 392 | | fs rms | |
| Bandwidth: 20 kHz to 80 MHz | | 400 | | fs rms | |
| Bandwidth: 50 kHz to 80 MHz | | 379 | | fs rms | |
| Bandwidth: 4 MHz to 80 MHz | | 172 | | fs rms | |
| $f_{REF} = 25 \text{ MHz}$; $f_{OUT} = 161.1328 \text{ MHz}$; $f_{LOOP} = 10 \text{ Hz}$; HSTL Driver | | | | | |
| Bandwidth: 5 kHz to 20 MHz | | 384 | | fs rms | |
| Bandwidth: 12 kHz to 20 MHz | | 378 | | fs rms | |
| Bandwidth: 20 kHz to 80 MHz | | 416 | | fs rms | |
| Bandwidth: 50 kHz to 80 MHz | | 396 | | fs rms | |
| Bandwidth: 4 MHz to 80 MHz | | 223 | | fs rms | |

| Parameter | Min | Typ | Max | Unit | Test Conditions/Comments |
|--|-----|------|-----|--------|--------------------------|
| $f_{REF} = 2 \text{ kHz}$; $f_{OUT} = 70.656 \text{ MHz}$; $f_{LOOP} = 10 \text{ Hz}$; HSTL Driver, 3.3 V CMOS Driver | | | | | |
| Bandwidth: 10 Hz to 30 MHz | | 3.19 | | ps rms | |
| Bandwidth: 12 kHz to 20 MHz | | 418 | | fs rms | |
| Bandwidth: 10 kHz to 400 kHz | | 339 | | fs rms | |
| Bandwidth: 100 kHz to 10 MHz | | 348 | | fs rms | |

ABSOLUTE MAXIMUM RATINGS

Table 20.

| Parameter | Rating |
|--|------------------------|
| 1.8 V Supply Voltage (VDD) | 2 V |
| 3.3 V Supply Voltage (VDD3) | 3.6 V |
| Maximum Digital Input Voltage | -0.5 V to VDD3 + 0.5 V |
| Storage Temperature Range | -65°C to +150°C |
| Operating Temperature Range | -40°C to +85°C |
| Lead Temperature (Soldering 10 sec) | 300°C |
| Junction Temperature | 150°C |

Stresses above those listed under Absolute Maximum Ratings may cause permanent damage to the device. This is a stress rating only; functional operation of the device at these or any other conditions above those indicated in the operational section of this specification is not implied. Exposure to absolute maximum rating conditions for extended periods may affect device reliability.

ESD CAUTION



ESD (electrostatic discharge) sensitive device. Charged devices and circuit boards can discharge without detection. Although this product features patented or proprietary protection circuitry, damage may occur on devices subjected to high energy ESD. Therefore, proper ESD precautions should be taken to avoid performance degradation or loss of functionality.

PIN CONFIGURATION AND FUNCTION DESCRIPTIONS

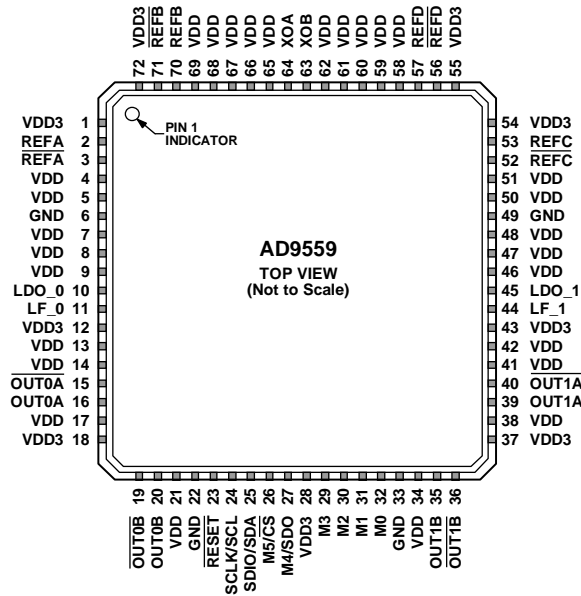

NOTES
 1. THE EXPOSED PAD IS THE GROUND CONNECTION ON THE CHIP. IT MUST BE SOLDERED TO THE ANALOG GROUND OF THE PCB TO ENSURE PROPER FUNCTIONALITY AND HEAT DISSIPATION, NOISE, AND MECHANICAL STRENGTH BENEFITS.

10644-002

Figure 2. Pin Configuration

Table 21. Pin Function Descriptions

| Pin No. | Mnemonic | Input/Output | Pin Type | Description |
|---|---------------------------|--------------|------------------------|--|
| 1, 12, 18, 28, 37, 43, 54, 55, 72 | VDD3 | I | Power | 3.3 V Power Supply. See the Power Supply Partitions section for information about the recommended grouping of the power supply pins. |
| 2 | REFA | I | Differential input | Reference A Input. This internally biased input is typically ac-coupled; when configured in this manner, it can accept any differential signal with single-ended swing up to 3.3 V. If dc-coupled, input can be LVPECL, LVDS, or single-ended CMOS. |
| 3 | $\overline{\text{REFA}}$ | I | Differential input | Complementary Reference A Input. Complementary signal to the input provided on Pin 2. |
| 4, 5, 7, 8, 9, 13, 14, 17, 21, 34, 38, 41, 42, 46, 47, 48, 50, 51, 58, 59, 60, 61, 62, 65, 66, 67, 68, 69 | VDD | I | Power | 1.8 V Power Supply. See the Power Supply Partitions section for information about the recommended grouping of the power supply pins. Note that, for Pin 34 and Pin 21, it is recommended that a Size 0201, 0.1 μF bypass capacitor be placed between Pin 33 and Pin 34, as well as between Pin 21 and Pin 22, as close as possible to the AD9559. |
| 6, 22, 33, 49 | GND | O | Ground | Connect these pins (along with the exposed die pad) to ground. |
| 10 | LDO_0 | I | LDO bypass | Output PLL0 Loop Filter Voltage Regulator. Connect a 0.47 μF capacitor from this pin to ground. This pin is also the ac ground reference for the integrated output PLL external loop filter. |
| 11 | LF_0 | I/O | Loop filter for APLL_0 | Loop Filter Node for the Output PLL0. Connect an external 6.8 nF capacitor from this pin to Pin 10 (LDO_0). |
| 15 | $\overline{\text{OUT0A}}$ | O | HSTL, LVDS, 1.8 V CMOS | PLL0 Complementary Output 0A. This output can be configured as HSTL, LVDS, or single-ended 1.8 V CMOS. |
| 16 | OUT0A | O | HSTL, LVDS, 1.8 V CMOS | PLL0 Output 0A. This output can be configured as HSTL, LVDS, or single-ended 1.8 V CMOS. LVPECL levels can be achieved by ac-coupling and using the Thevenin-equivalent termination as described in the Input/Output Termination Recommendations section. |

| Pin No. | Mnemonic | Input/Output | Pin Type | Description |
|----------------|----------------------------|--------------|------------------------------------|---|
| 19 | OUT0B | O | HSTL, LVDS, 1.8 V CMOS, 3.3 V CMOS | PLL0 Complementary Output 0B. This output can be configured as HSTL, LVDS, or single-ended 1.8 V or 3.3 V CMOS. |
| 20 | OUT0B | O | HSTL, LVDS, 1.8 V CMOS, 3.3 V CMOS | PLL0 Output 0B. This output can be configured as HSTL, LVDS, or single-ended 1.8 V or 3.3 V CMOS. LVPECL levels can be achieved by ac-coupling and using the Thevenin-equivalent termination as described in the Input/Output Termination Recommendations section. |
| 23 | RESET | I | 3.3 V CMOS Logic | Chip Reset. When this active low pin is asserted, the chip goes into reset. This pin has an internal 50 kΩ pull-up resistor. |
| 24 | SCLK/SCL | I | 3.3 V CMOS | Serial Programming Clock in SPI Mode (SCLK). Data clock for serial programming. Serial Clock Pin in I ² C Mode (SCL). |
| 25 | SDIO/SDA | I/O | 3.3 V CMOS | Serial Data Input/Output (SDIO). When the device is in 4-wire SPI mode, data is written via this pin. In 3-wire SPI mode, data reads and writes both occur on this pin. There is no internal pull-up/pull-down resistor on this pin. Serial Data Pin in I ² C Mode (SDA). |
| 26 | M5/ $\overline{\text{CS}}$ | I/O | 3.3 V CMOS | Configurable I/O Pin (M5). Used for status and control of the AD9559 . Chip Select in SPI Mode ($\overline{\text{CS}}$). Active low input. When programming a device in SPI, this pin must be held low. In systems where more than one AD9559 is present, this pin enables individual programming of each AD9559 . This pin has an internal 10 kΩ pull-up resistor. |
| 27 | M4/SDO | I/O | 3.3 V CMOS | Configurable I/O Pin (M4). Used for status and control of the AD9559 . Serial Data Output (SDO). In 4-wire SPI mode, this pin is used for reading serial data. |
| 29, 30, 31, 32 | M3, M2, M1, M0 | I/O | 3.3 V CMOS | Configurable I/O Pins. These pins are used for status and control of the AD9559 . These pins are also used at power-up and reset to control the serial port configuration and EEPROM loading. See Table 23 and Table 25 for more information. These pins do NOT have internal pull-down resistors. |
| 35 | OUT1B | O | HSTL, LVDS, 1.8 V CMOS, 3.3 V CMOS | PLL1 Output 1B. This output can be configured as HSTL, LVDS, or single-ended 1.8 V or 3.3 V CMOS. LVPECL levels can be achieved by ac-coupling and using the Thevenin-equivalent termination as described in the Input/Output Termination Recommendations section. |
| 36 | $\overline{\text{OUT1B}}$ | O | HSTL, LVDS, 1.8 V CMOS, 3.3 V CMOS | PLL1 Complementary Output 1B. This output can be configured as HSTL, LVDS, or single-ended 1.8 V or 3.3 V CMOS. |
| 39 | OUT1A | O | HSTL, LVDS, 1.8 V CMOS | PLL1 Output 1A. This output can be configured as HSTL, LVDS, or single-ended 1.8 V CMOS. LVPECL levels can be achieved by ac-coupling and using the Thevenin-equivalent termination as described in the Input/Output Termination Recommendations section. |
| 40 | $\overline{\text{OUT1A}}$ | O | HSTL, LVDS, 1.8 V CMOS | PLL1 Complementary Output 1A. This output can be configured as HSTL, LVDS, or single-ended 1.8 V CMOS. |
| 44 | LF_1 | I/O | Loop filter for APLL_1 | Loop Filter Node for the Output PLL1. Connect an external 6.8 nF capacitor from this pin to Pin 45 (LDO_1). |
| 45 | LDO_1 | I | LDO bypass | Output PLL1 Loop Filter Voltage Regulator. Connect a 0.47 μF capacitor from this pin to ground. This pin is also the ac ground reference for the integrated output PLL external loop filter. |
| 52 | $\overline{\text{REFC}}$ | I | Differential input | Complementary Reference C Input. Complementary signal to the input provided on Pin 53. |
| 53 | REFC | I | Differential input | Reference C Input. This internally biased input is typically ac-coupled; when configured in that manner, it can accept any differential signal with single-ended swing up to 3.3 V. If dc-coupled, input can be LVPECL, LVDS, or single-ended CMOS. |
| 56 | $\overline{\text{REFD}}$ | I | Differential input | Complementary Reference D Input. Complementary signal to the input provided on Pin 57. |
| 57 | REFD | I | Differential input | Reference D Input. This internally biased input is typically ac-coupled; when configured in this manner, it can accept any differential signal with single-ended swing up to 3.3 V. If dc-coupled, input can be LVPECL, LVDS, or single-ended CMOS. |

| Pin No. | Mnemonic | Input/ Output | Pin Type | Description |
|---------|--------------------------|------------------|--------------------|--|
| 63 | XOB | I | Differential input | Complementary System Clock Input. Complementary signal to XOA. XOB contains internal dc biasing and should be ac-coupled with a 0.1 μ F capacitor except when using a crystal. When a crystal is used, connect the crystal across XOA and XOB. |
| 64 | XOA | I | Differential input | System Clock Input. XOA contains internal dc biasing and should be ac-coupled with a 0.01 μ F capacitor except when using a crystal. When a crystal is used, connect the crystal across XOA and XOB. Single-ended 1.8 V CMOS is also an option, but a spur may be introduced if the duty cycle is not 50%. When using XOA as a single-ended input, connect a 0.1 μ F capacitor from XOB to ground. |
| 70 | REFB | I | Differential input | Reference B Input. This internally biased input is typically ac-coupled; when configured in this manner, it can accept any differential signal with single-ended swing up to 3.3 V. If dc-coupled, input can be LVPECL, LVDS, or single-ended CMOS. |
| 71 | $\overline{\text{REFB}}$ | I | Differential input | Complementary Reference B Input. Complementary signal to the input provided on Pin 70. |
| EP | GND | O | Exposed pad | The exposed pad is the ground connection on the chip. It must be soldered to the analog ground of the PCB to ensure proper functionality and heat dissipation, noise, and mechanical strength benefits. |

TYPICAL PERFORMANCE CHARACTERISTICS

f_R = input reference clock frequency; f_{OUT} = output clock frequency; f_{SYS} = SYSCLK input frequency; VDD3 and VDD at nominal supply voltage.

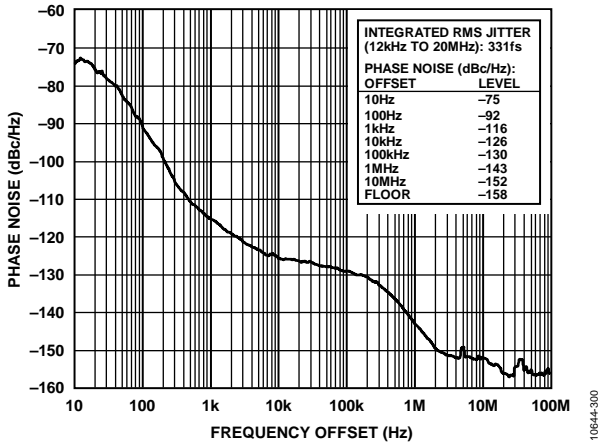

Absolute Phase Noise (Output Driver = HSTL),
 $f_R = 19.44$ MHz, $f_{OUT} = 156.25$ MHz,
 DPLL Loop BW = 50 Hz, $f_{SYS} = 49.152$ MHz Crystal

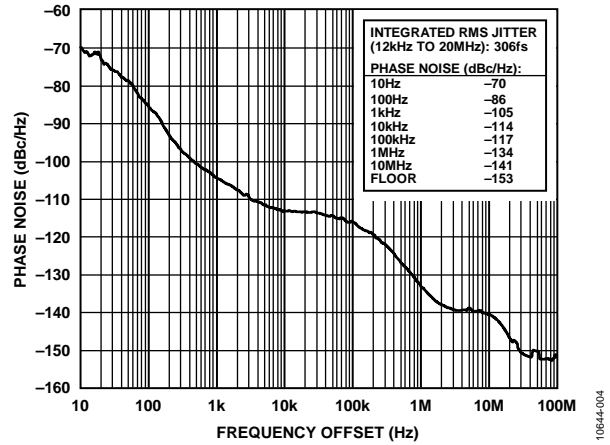

Figure 4. Absolute Phase Noise (Output Driver = HSTL),
 $f_R = 19.44$ MHz, $f_{OUT} = 644.53125$ MHz,
 DPLL Loop BW = 50 Hz, $f_{SYS} = 49.152$ MHz Crystal

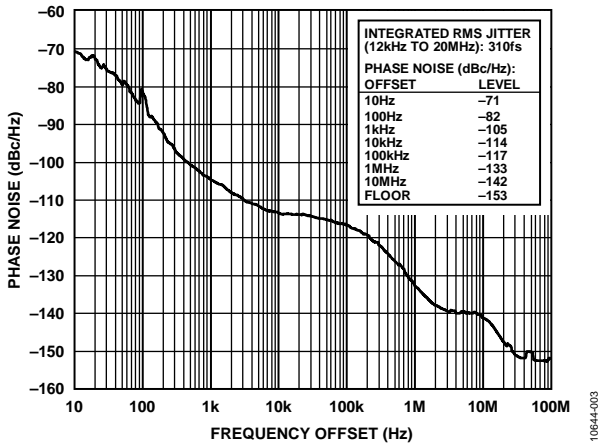

Figure 3. Absolute Phase Noise (Output Driver = HSTL),
 $f_R = 19.44$ MHz, $f_{OUT} = 622.08$ MHz,
 DPLL Loop BW = 50 Hz, $f_{SYS} = 49.152$ MHz Crystal

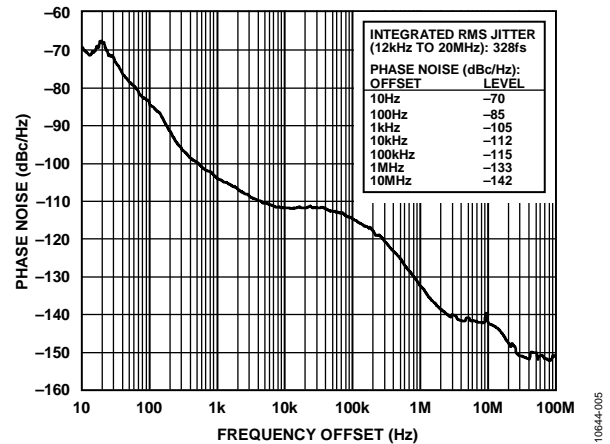

Figure 5. Absolute Phase Noise (Output Driver = HSTL),
 $f_R = 19.44$ MHz, $f_{OUT} = 693.482991$ MHz,
 DPLL Loop BW = 50 Hz, $f_{SYS} = 49.152$ MHz Crystal

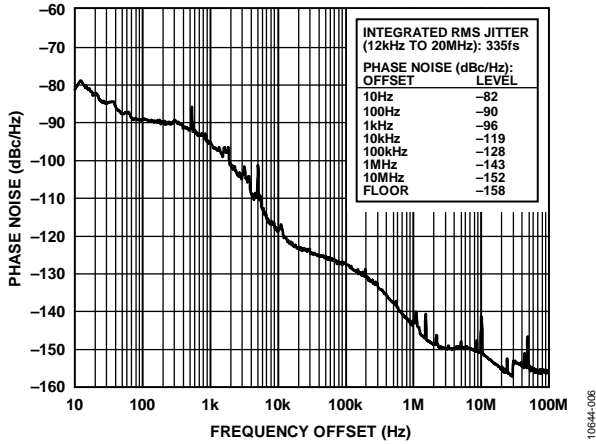

Figure 6. Absolute Phase Noise (Output Driver = HSTL),
 $f_R = 19.44$ MHz, $f_{OUT} = 174.703$ MHz,
 DPLL Loop BW = 1 kHz, $f_{SYS} = 49.152$ MHz Crystal

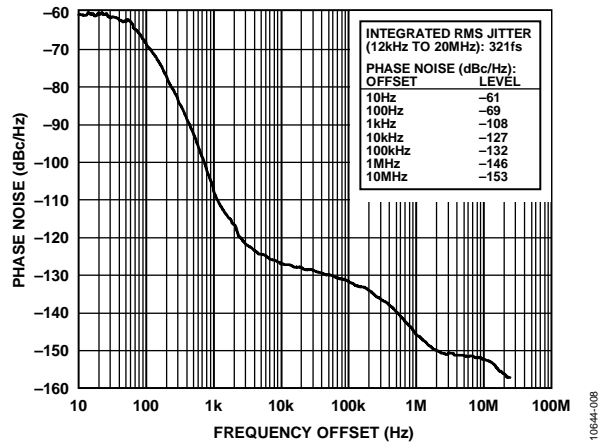

Figure 8. Absolute Phase Noise (Output Driver = HSTL),
 $f_R = 2$ kHz, $f_{OUT} = 125$ MHz,
 DPLL Loop BW = 100 Hz, $f_{SYS} = 49.152$ MHz Crystal

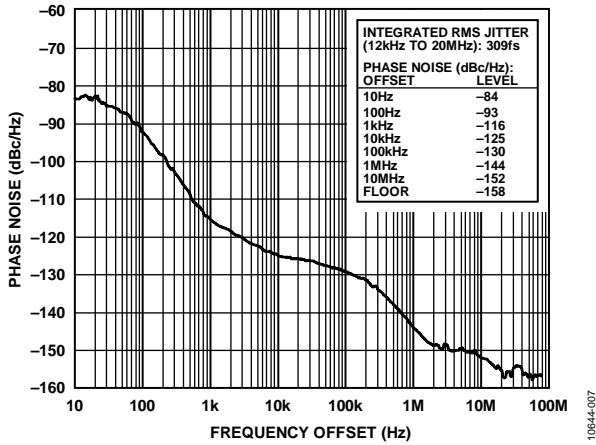

Figure 7. Absolute Phase Noise (Output Driver = 3.3V CMOS),
 $f_R = 19.44$ MHz, $f_{OUT} = 161.1328125$ MHz,
 DPLL Loop BW = 100 Hz, $f_{SYS} = 49.152$ MHz Crystal

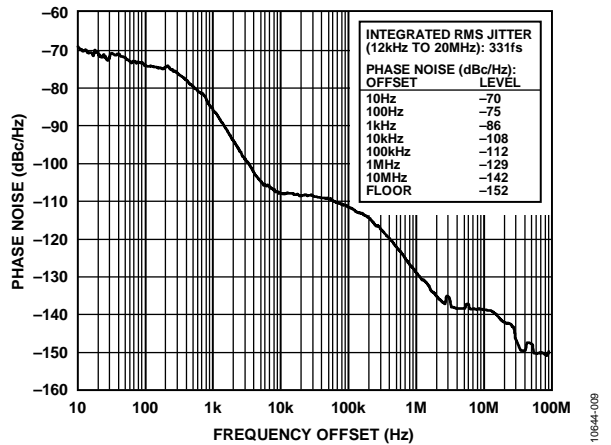

Figure 9. Absolute Phase Noise (Output Driver = HSTL),
 $f_R = 25$ MHz, $f_{OUT} = 1$ GHz,
 DPLL Loop BW = 500 Hz, $f_{SYS} = 49.152$ MHz Crystal

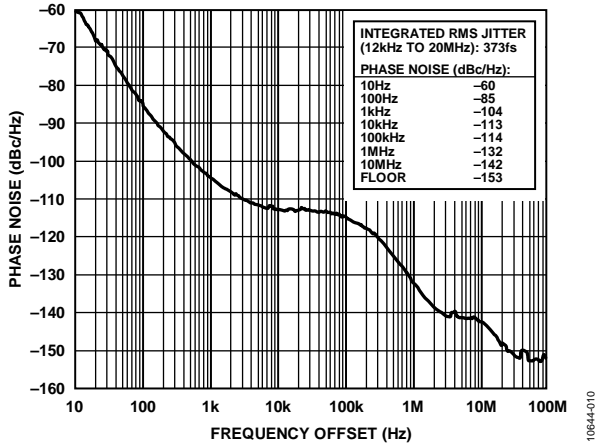

Figure 10. Absolute Phase Noise (Output Driver = HSTL),
 $f_R = 19.44$ MHz, $f_{OUT} = 644.53$ MHz,
 DPLL Loop BW = 10 Hz, $f_{SYS} = 19.2$ MHz TCXO

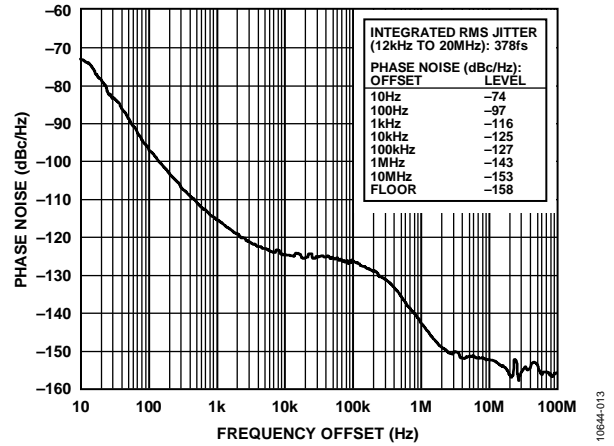

Figure 13. Absolute Phase Noise (Output Driver = 3.3 V CMOS),
 $f_R = 19.44$ MHz, $f_{OUT} = 161.1328125$ MHz,
 DPLL Loop BW = 10 Hz, $f_{SYS} = 19.2$ MHz TCXO

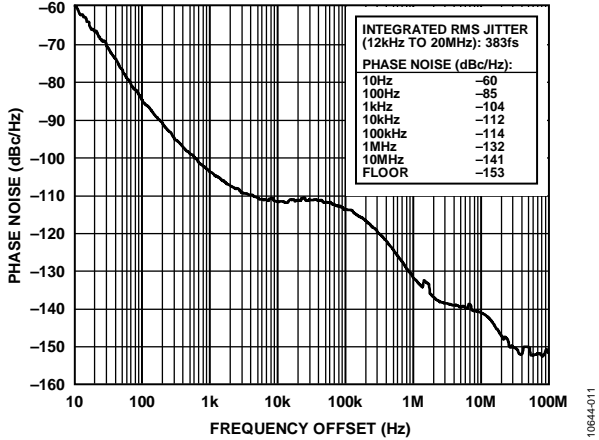

Figure 11. Absolute Phase Noise (Output Driver = HSTL),
 $f_R = 19.44$ MHz, $f_{OUT} = 693.482991$ MHz,
 DPLL Loop BW = 10 Hz, $f_{SYS} = 19.2$ MHz TCXO

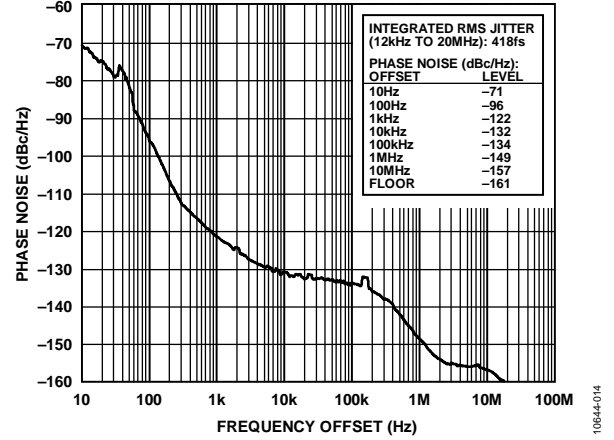

Figure 14. Absolute Phase Noise (Output Driver = 1.8V CMOS),
 $f_R = 2$ kHz, $f_{OUT} = 70.656$ MHz,
 DPLL Loop BW = 10 Hz, $f_{SYS} = 19.2$ MHz TCXO

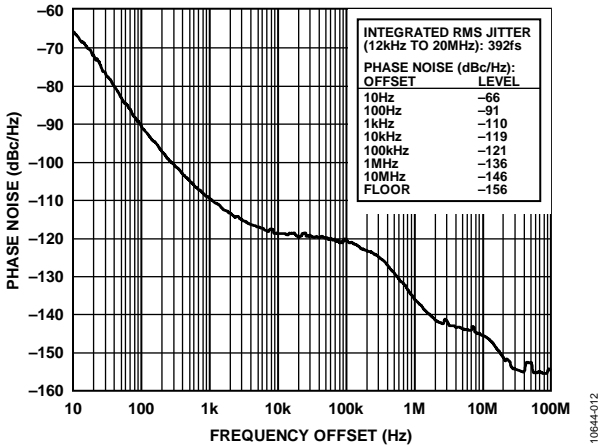

Figure 12. Absolute Phase Noise (Output Driver = HSTL),
 $f_R = 19.44$ MHz, $f_{OUT} = 312.5$ MHz,
 DPLL Loop BW = 0.1 Hz, $f_{SYS} = 19.2$ MHz TCXO

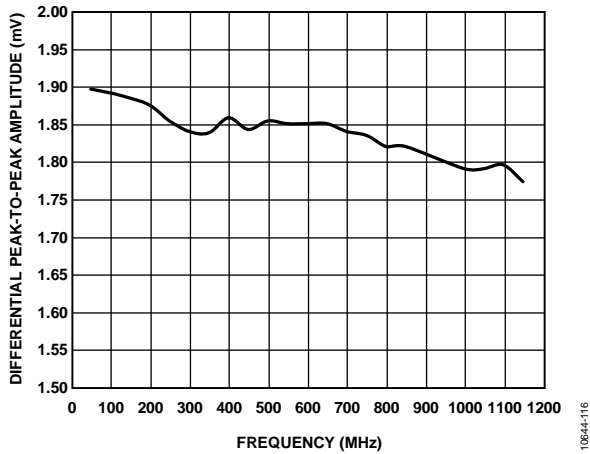

Figure 15. Amplitude vs. Toggle Rate, HSTL Mode (LVPECL-Compatible Mode)

10644-116

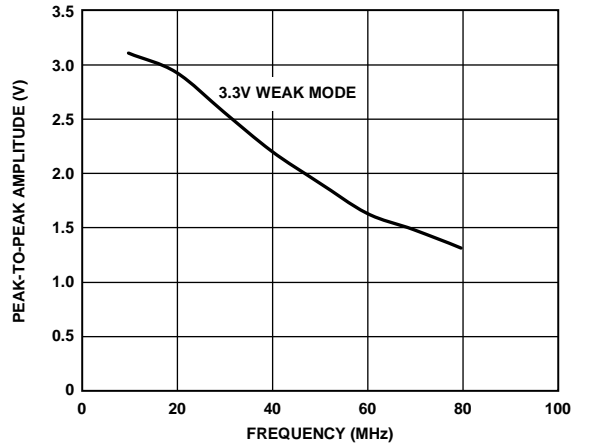

Figure 18. Amplitude vs. Toggle Rate with 10 pF Load, 3.3 V (Weak Mode) CMOS

10644-119

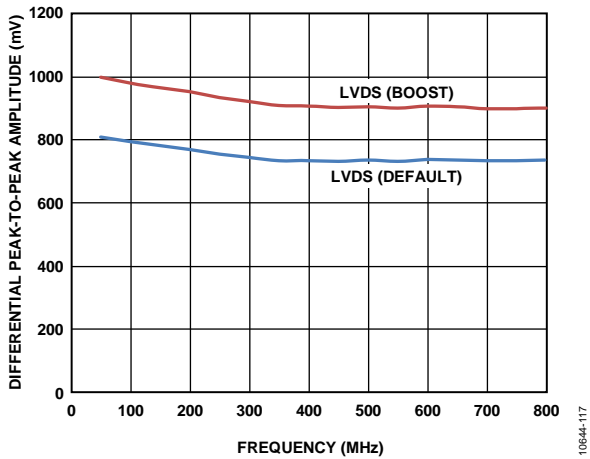

Figure 16. Amplitude vs. Toggle Rate, LVDS

10644-117

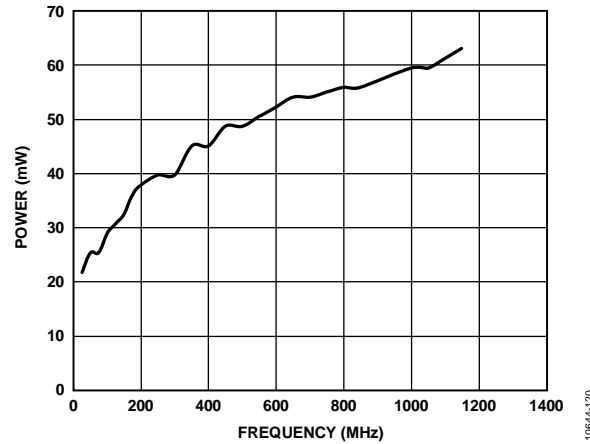

Figure 19. Power Consumption vs. Frequency, HSTL Mode on Output Driver Power Supply Only (Pin 17, Pin 21, Pin 34, and Pin 38)

10644-120

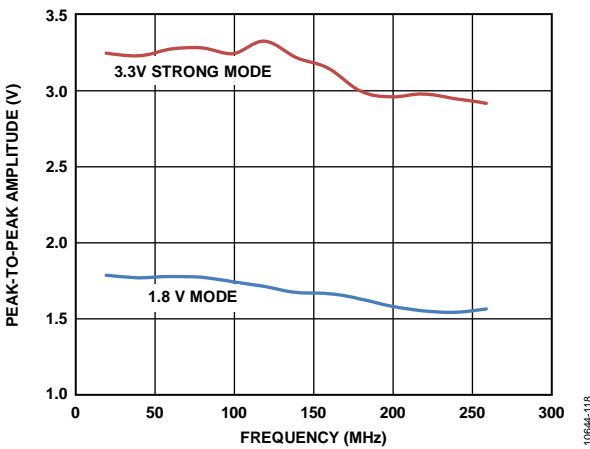

Figure 17. Amplitude vs. Toggle Rate with 10 pF Load, 3.3 V (Strong Mode) and 1.8 V CMOS

10644-118

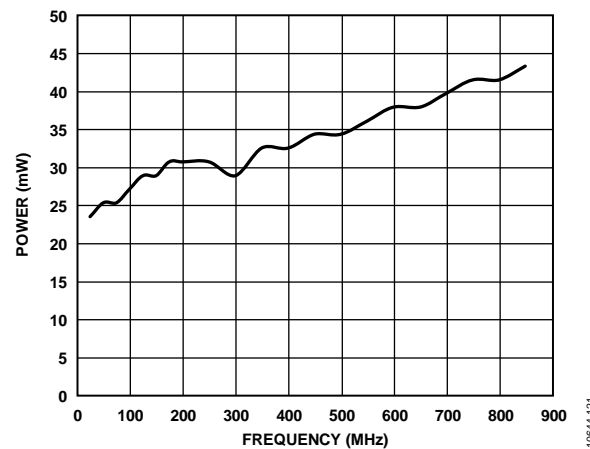

Figure 20. Power Consumption vs. Frequency, LVDS Mode on Output Driver Power Supply Only (Pin 17, Pin 21, Pin 34, and Pin 38)

10644-121

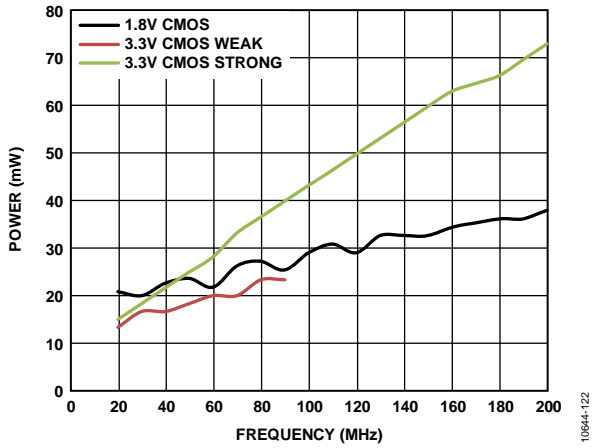

Figure 21. Power Consumption vs. Frequency for Two CMOS Drivers; Power Is Measured on Output Driver Power Supply Only (Pin 17, Pin 21, Pin 34, and Pin 38 for 1.8 V CMOS Mode or on Pin 18 and Pin 37 for 3.3 V CMOS Mode); $C_{LOAD} = 80$ pF

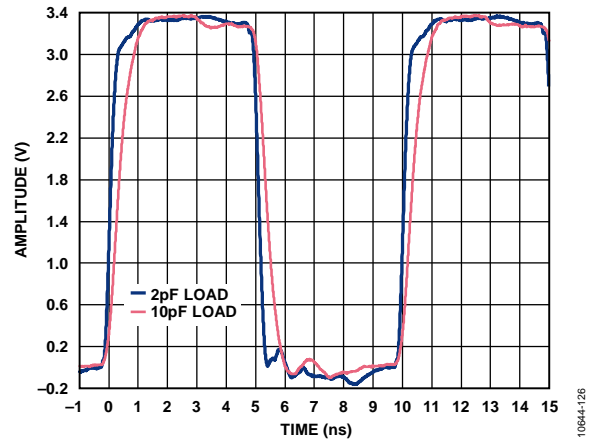

Figure 24. Output Waveform, 3.3 V CMOS (100 MHz, Strong Mode)

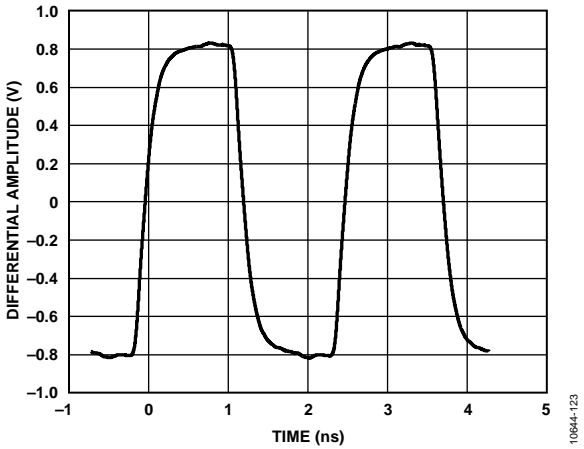

Figure 22. Output Waveform, HSTL (400 MHz)

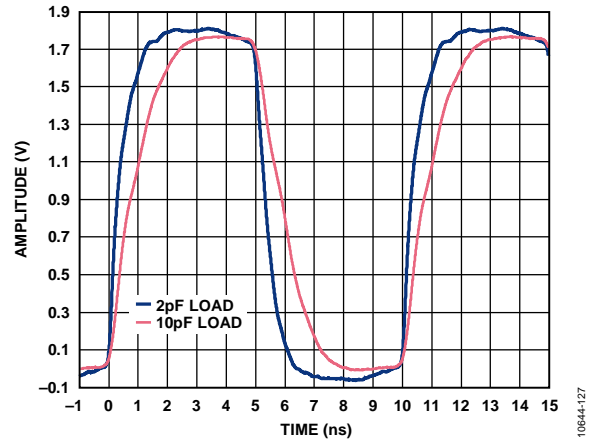

Figure 25. Output Waveform, 1.8 V CMOS (100 MHz)

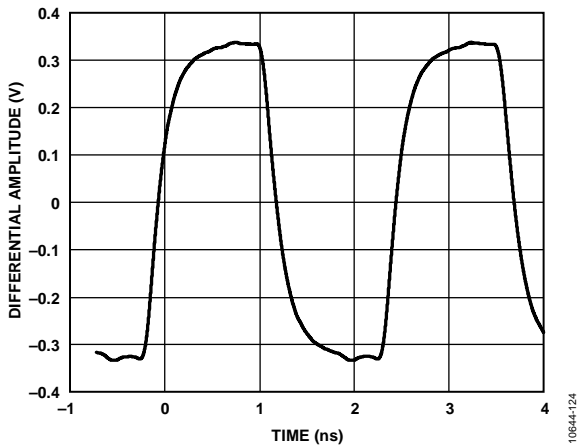

Figure 23. Output Waveform, LVDS (400 MHz)

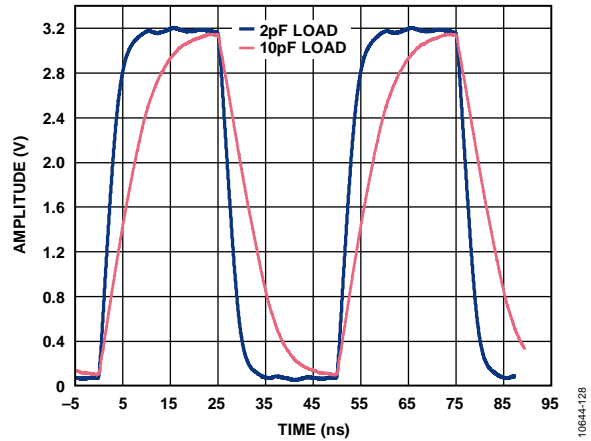

Figure 26. Output Waveform, 3.3 V CMOS (20 MHz, Weak Mode)

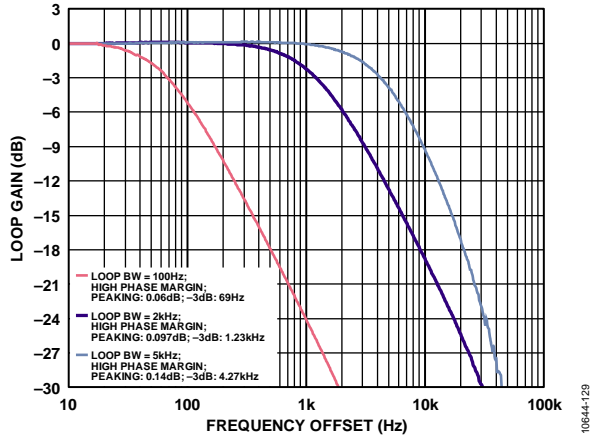

Figure 27. Closed-Loop Transfer Function for 100 Hz, 2 kHz, and 5 kHz Loop Bandwidth Settings; High Phase Margin Loop Filter Setting (This figure is compliant with Telcordia GR-253 jitter transfer test for loop bandwidths < 2 kHz.) Note that bandwidth is defined as the point where the open loop gain = 0 dB.

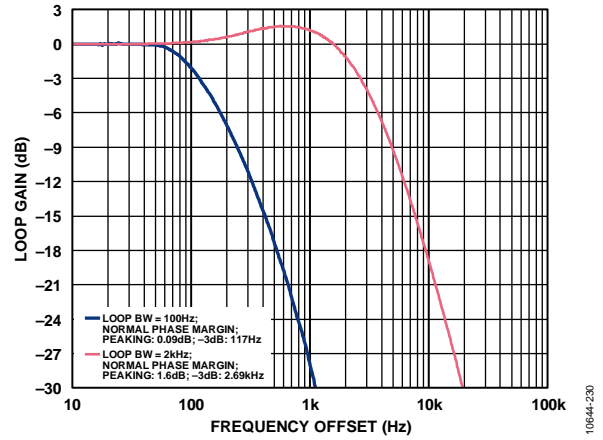

Figure 28. Closed-Loop Transfer Function for 100 Hz and 2 kHz Loop Bandwidth Settings; Normal Phase Margin Loop Filter Setting Note that bandwidth is defined as the point where the open loop gain = 0 dB.

INPUT/OUTPUT TERMINATION RECOMMENDATIONS

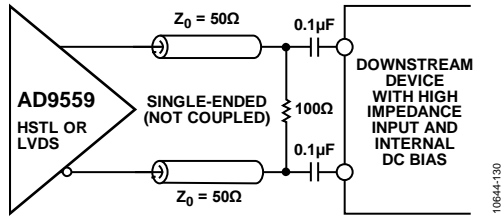

Figure 29. AC-Coupled LVDS or HSTL Output Driver (100 Ω resistor can be placed on either side of decoupling capacitors and should be as close to the destination receiver as possible.)

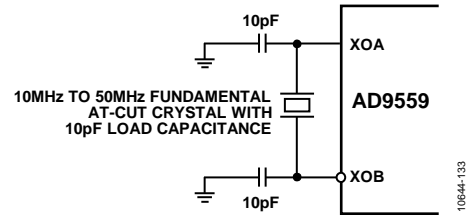

Figure 32. System Clock Input (XOA/XOB) in Crystal Mode (The recommended $C_{LOAD} = 10\text{ pF}$ is shown. The values of 10 pF shunt capacitors shown here should equal the C_{LOAD} of the crystal.)

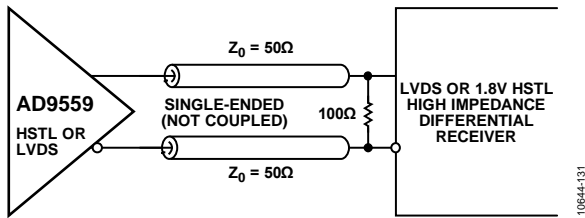

Figure 30. DC-Coupled LVDS or HSTL Output Driver

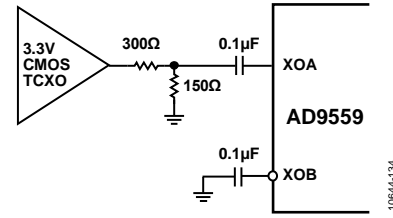

Figure 33. System Clock Input (XOA, XOB) When Using a TCXO/OCXO with 3.3 V CMOS Output

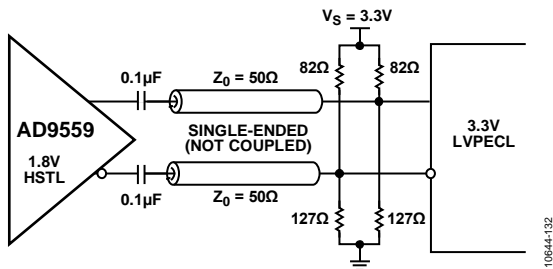

Figure 31. Interfacing the HSTL Driver to a 3.3 V LVPECL Input (This method incorporates impedance matching and dc-biasing for bipolar LVPECL receivers. If the receiver is self-biased, the termination scheme shown in Figure 29 is recommended.)

GETTING STARTED

CHIP POWER MONITOR AND STARTUP

The [AD9559](#) monitors the voltage on the power supplies at power-up. When VDD3 is greater than $2.35\text{ V} \pm 0.1\text{ V}$ and VDD is greater than $1.4\text{ V} \pm 0.05\text{ V}$, the device generates a 20 ms reset pulse. The power-up reset pulse is internal and independent of the RESET pin. This internal power-up reset sequence eliminates the need for the user to provide external power supply sequencing. Within 45 ns after the internal reset pulse, the M5 to M0 multifunction pins behave as high impedance digital inputs and continue to do so until programmed otherwise.

During a device reset (either via the power-up reset pulse or the RESET pin), the M3 to M0 multifunction pins behave as high impedance inputs; and at the point where the reset condition is cleared, level-sensitive latches capture the logic pattern that is present on the multifunction pins.

MULTIFUNCTION PINS AT RESET/POWER-UP

At start-up, the M0 and M1 pins allow the user to either bypass EEPROM loading or load one of three EEPROM profiles. See Table 23 for information on setting the M0 and M1 pins.

Pin M3 selects SPI or I²C mode: SPI mode is set by pulling M3 low at startup. If M3 is high, I²C mode is set, and the M4 and M5 pins determine the I²C address. See Table 25 for information on SPI/I²C configuration.

If 4-wire SPI mode is selected, by setting Bit 7 of Register 0x0000, the M4/SDO pin functions as SDO and is not available for other functions as an M pin. However, in I²C mode and in 3-wire SPI mode, M4 is available as the fifth M pin.

A sixth M pin, M5, is available if the serial port is in I²C mode or 2-wire SPI mode. In 2-wire SPI mode, there is no CS pin available, and it is assumed that the [AD9559](#) is the only device on the SPI bus.

DEVICE REGISTER PROGRAMMING USING A REGISTER SETUP FILE

The evaluation software contains a programming wizard and a convenient graphical user interface that assists the user in determining the optimal configuration for the DPLLs, APLLs, and SYSCLK based on the desired input and output frequencies. It generates a register setup file with a .STP extension that is easily readable using a text editor.

The user can configure PLL_0 and PLL_1 independently. To do so, the user should program the common registers (such as the system clock and reference inputs) first. Next, the registers that are unique to PLL_0 or PLL_1 can be configured independently.

After using the evaluation software to create the setup file, use the following sequence to program the [AD9559](#):

1. Set user free run mode.
DPLL_0: Register 0x0A22 = 0x01.
DPLL_1: Register 0x0A42 = 0x01.
2. Update all registers (also referred to as IO_UPDATE).
Register 0x0005 = 0x01.
3. Write the register values in the STP file from Address 0x0000 to Address 0x0207.
4. IO_UPDATE. Register 0x0005 = 0x01.
5. Verify that SYSCLK is stable. Register 0x0D01[1] = 1.
The user must issue an IO_UPDATE each time before polling Register 0x0D01.
6. For the outputs to toggle prior to DPLL phase or frequency lock, set the following:
APLL_0: Register 0x0A20 = 0x04 (soft sync).
APLL_1: Register 0x0A40 = 0x04 (soft sync).
IO_UPDATE. Register 0x0005 = 0x01.
7. Write the rest of the registers in the STP file starting at Address 0x0300.
8. Calibrate APLL on next IO_UPDATE.
APLL_0: Register 0x0A20 = 0x02.
APLL_1: Register 0x0A40 = 0x02.
9. IO_UPDATE. Register 0x0005 = 0x01.
10. Clear user free run mode.
DPLL_0: Register 0x0A22[0] = 0b.
DPLL_1: Register 0x0A42[0] = 0b.
11. IO_UPDATE. Register 0x0005 = 0x01.

REGISTER PROGRAMMING OVERVIEW

This section provides a programming overview of the register blocks in the AD9559, describing what they do and why they are important. This is supplemental information only, needed only if the user wishes to load the registers without using the STP file.

The AD9559 evaluation software contains a wizard that determines the register settings based on the user's input and output frequencies. It is strongly recommended that the evaluation software be used to determine these settings.

Multifunction Pins (Optional)

This step is required only if the user intends to use any of the multifunction pins for status or control. The multifunction pin parameters are at Register 0x0100 to Register 0x0107.

Table 196 has a list of M pin output functions, and Table 197 has a list of M pin input functions.

IRQ Functions (Optional)

This step is required only if the user intends to use the IRQ feature. The IRQ functions are divided into three groups: common, PLL_0, and PLL_1.

The user must first choose the events that trigger an IRQ and then set them in Register 0x010A to Register 0x0112. Next, an M pin must be assigned to the IRQ function. The user can choose to dedicate one M pin to each of the three IRQ groups, or one M pin can be assigned for all IRQs.

The IRQ monitor registers are located at Register 0x0D08 to Register 0x0D10. If the desired bits in the IRQ mask registers at Register 0x010A to Register 0x0112 are set high, the appropriate IRQ monitor bit at Register 0x0D08 to Register 0x0D10 is set high when the indicated event occurs.

Individual IRQ events are cleared by using the IRQ clearing registers at Register 0x0A05 to Register 0x0A0E or by setting the clear all IRQs bit (Register 0x0A05[0]) to 1b.

The default values of the IRQ mask registers are such that interrupts are not generated. The default IRQ pin mode is open-drain NMOS.

Watchdog Timer (Optional)

This step is required only if the user intends to use the watchdog timer. The watchdog timer control is at Register 0x0108 and Register 0x0109. The watchdog timer is disabled by default.

The watchdog timer is useful for generating an IRQ after a fixed amount of time. The timer is reset by setting the clear watchdog timer bit in Register 0x0A05[7] to 1.

The user can also program an M pin for the watchdog timer output. In this mode, the M pin generates a 40 ns pulse every time the watchdog timer expires.

System Clock Configuration

The system clock multiplier (SYSCLK) parameters are at Register 0x0200 to Register 0x0207. For optimal performance, use the following steps:

1. Set the system clock PLL input type and divider values.
2. Set the system clock period.
It is essential to program the system clock period because many of the AD9559 subsystems rely on this value.
3. Set the system clock stability timer.
It is highly recommended that the system clock stability timer be programmed. This is especially important when using the system clock multiplier and applies when using an external system clock source, especially if the external source is not expected to be completely stable when power is applied to the AD9559. The system clock stability timer specifies the amount of time that the system clock PLL must be locked before the part declares that the system clock is stable. The default value is 50 ms.
4. Update all registers (Register 0x0005 = 0x01).

Important Note

The system clock must be stable for the digital PLL blocks to function correctly and read back the registers updated on the system clock domain. These registers include the status registers, as well as the free running tuning word. Therefore, when debugging the AD9559, the user must first ensure that the system clock is stable by checking Bit 1 in Register 0x0D01.

Reference Inputs

The reference input parameters and reference dividers are common to both PLLs; there is only one reference divider (R divider) for each reference input. The register address for each reference input is as follows:

- REFA: Register 0x0300 to Register 0x031A
- REFB: Register 0x0320 to Register 0x033A
- REFC: Register 0x0340 to Register 0x035A
- REFD: Register 0x0360 to Register 0x037A

These registers include the following settings:

- Reference logic family
- Reference divider (R divider value)
- Reference input period and tolerance
- Reference validation timer
- Phase and frequency lock detector settings

Other reference input settings can be found at the following register addresses:

- Reference input enable information is found in the DPLL Feedback Dividers section.
- Reference power-down is found in Register 0x0A01.
- Reference priority settings are found in the DPLL profiles.
DPLL_0: Registers 0x0440 through 0x0473
DPLL_1: Registers 0x0540 through 0x0573
- Reference switching mode settings are found in
DPLL_0: Register 0x0A22
DPLL_1: Register 0x0A42

DPLL Controls and Settings

The DPLL control parameters are separate for DPLL_0 and DPLL_1. They reside in the following locations:

- DPLL_0: Register 0x0400 to Register 0x0415
- DPLL_1: Register 0x0500 to Register 0x0515

These registers include the following settings:

- 30-bit free running frequency
- DPLL pull-in range limits
- DPLL closed-loop phase offset
- Tuning word history control (for holdover operation)
- Phase slew control (for controlling the phase slew rate during a closed-loop phase adjustment)

With the exception of the free running tuning word, the default values of these registers are fine for normal operation. The free running frequency of the DPLL determines the frequency that appears at the APLL input when user free run mode is selected. The correct free running frequency is required for the APLL to calibrate and lock correctly.

Note that the user free run bits, which enable user free run mode, can be found in the following registers:

- DPLL_0: Register 0x0A22 = 0x01
- DPLL_1: Register 0x0A42 = 0x01

Output PLLs (APLLs) and Output Drivers

The registers controlling the APLLs and output drivers reside at the following locations:

- APLL_0: Register 0x0420 to Register 0x042E
- APLL_1: Register 0x0520 to Register 0x052E

The following functions are controlled in these registers:

- APLL settings (feedback divider, charge pump current)
- Output synchronization mode
- Output divider values
- Output enable/disable (disabled by default)
- Output logic type

Note that the APLL calibration and synchronization bits can be found in the following registers:

- APLL_0: Register 0x0A20
- APLL_1: Register 0x0A40

DPLL Feedback Dividers

Each digital PLL has separate feedback divider settings for each reference input. This allows the user to have each digital PLL perform a different frequency translation. However, there is only one reference divider (R divider) for each reference input.

The feedback divider register settings reside in the following locations:

- DPLL_0, REFA: Register 0x0440 to Register 0x044C
- DPLL_0, REFB: Register 0x044D to Register 0x0459
- DPLL_0, REFC: Register 0x045A to Register 0x0466
- DPLL_0, REFD: Register 0x0467 to Register 0x0473
- DPLL_1, REFC: Register 0x0540 to Register 0x054C
- DPLL_1, REFD: Register 0x054D to Register 0x0559
- DPLL_1, REFA: Register 0x055A to Register 0x0566
- DPLL_1, REFB: Register 0x0567 to Register 0x0573

These registers include the following settings:

- Reference priority
- Reference input enable (separate for each DPLL)
- DPLL loop bandwidth
- DPLL loop filter
- DPLL feedback divider (integer portion)
- DPLL feedback divider (fractional portion)

Common Operational Controls

The common operational controls reside at Register 0x0A00 to Register 0x0A0E and include the following:

- Simultaneous calibration and synchronization of both PLLs
- Global power-down
- Reference power-down
- Reference validation override
- IRQ clearing (for all IRQs)

PLL_0 and PLL_1 Operational Controls

The PLL_0 and PLL_1 operational controls are located at Register 0x0A20 to Register 0x0A44 and include the following:

- APLL calibration and synchronization
- Output driver enable and power-down
- DPLL reference input switching modes
- DPLL phase offset control

APLL VCO Calibration

VCO calibration ensures that, at the time of calibration, the dc control voltage of the APLL VCO is centered in the middle of its operating range. The user can calibrate VCO_0 independently of VCO_1, and vice versa. It is important to remember the following conditions when calibrating the APLL VCO:

- The system clock must be stable.
- The APLL VCO must have the correct frequency from the 30-bit DCO (digitally controlled oscillator) during calibration. The free running tuning word is found in
DPLL_0: Registers 0x0400 to 0x0403
DPLL_1: Registers 0x0500 to 0x0503
- The APLL VCO must be recalibrated any time the APLL frequency changes.
- APLL VCO calibration occurs on the low-to-high transition of the APLL VCO calibration bit.
APLL_0: Register 0x0A20[1]
APLL_1: Register 0x0A40[1]
- The VCO calibration bit is not an autoclearing bit. Therefore, this bit must be cleared (and an IO_UPDATE issued) before the APLL is recalibrated.
- The best way to monitor successful APLL calibration is by monitoring the APLL locked bit, in the following registers:
APLL_0: Register 0x0D20[3]
APLL_1: Register 0x0D40[3]

Generate the Output Clock

If Register 0x0425 (for PLL_0) and/or Register 0x0525 (for PLL_1) is programmed for automatic clock distribution synchronization via the DPLL phase or frequency lock, the synthesized output signal appears at the clock distribution outputs. Otherwise, set and then clear the soft sync bit (Bit 2 in Register 0x0A20 for APLL_0 and Register 0x0A40 for APPL_1) or use a multifunction pin input (if programmed accordingly) to generate a clock distribution sync pulse, which causes the synthesized output signal to appear at the clock distribution outputs.

Generate the Reference Acquisition

After the registers are programmed, clear the user free run bit (Bit 0 in Register 0x0A22 for DPLL_0 and Register 0x0A42 for DPPL_1) and issue an IO_UPDATE using Register 0x0005[0] to invoke all of the register settings programmed up to this point.

The DPLLs lock to the first available reference that has the highest priority.

THEORY OF OPERATION

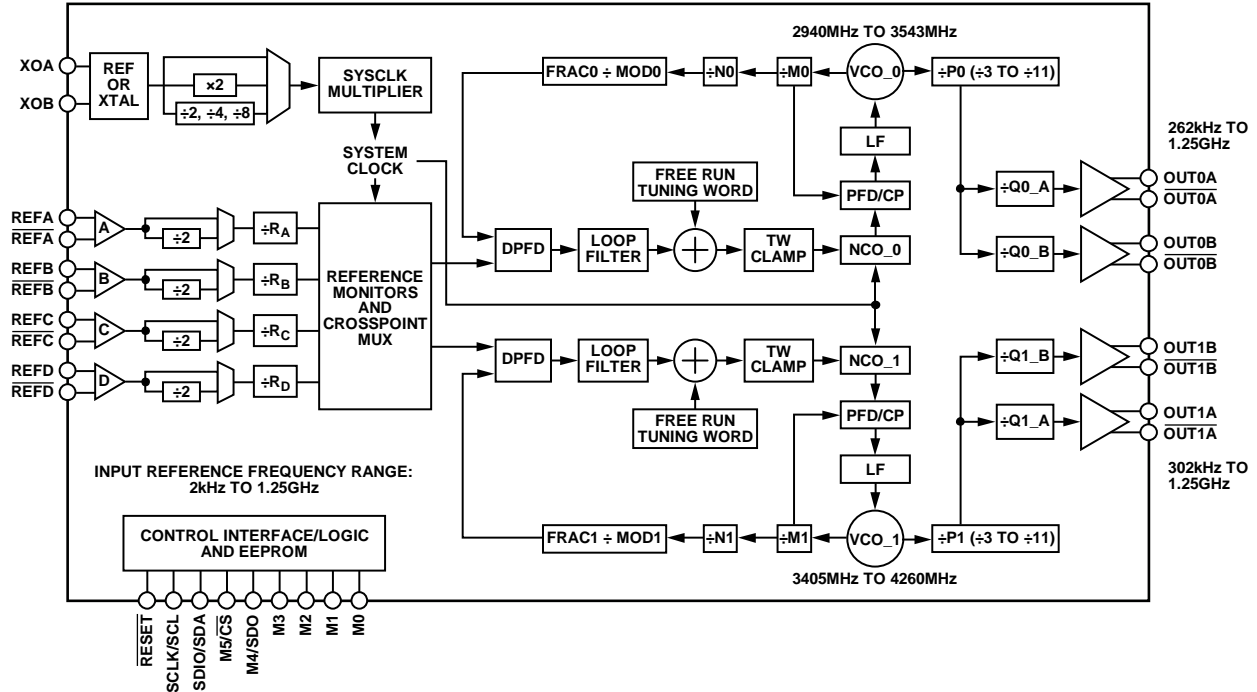

Figure 34. Detailed Block Diagram

10844-035

OVERVIEW

The AD9559 provides clocking outputs that are directly related in phase and frequency to the selected (active) reference but with jitter characteristics governed by the system clock, the digitally controlled oscillator (DCO), and the analog output PLL (APLL). The AD9559 can be thought of as two copies of the AD9557 inside one package, with a 4:2 crosspoint controlling the reference inputs. The AD9559 supports up to four reference inputs and input frequencies ranging from 2 kHz to 1250 MHz. The cores of this product are two digital phase-locked loops (DPLLs). Each DPLL has a programmable digital loop filter that greatly reduces jitter transferred from the active reference to the output, and these two DPLLs operate completely independently of each other. The AD9559 supports both manual and automatic holdover. While in holdover, the AD9559 continues to provide an output as long as the system clock is present. The holdover output frequency is a time average of the output frequency history just prior to the transition to the holdover condition. The device offers manual and automatic reference switchover capability if the active reference is degraded or fails completely. The AD9559 also has adaptive clocking capability that allows the user to dynamically change the DPLL divide ratios while the DPLLs are locked.

The AD9559 includes a system clock multiplier, two DPLLs, and two APLLs. The input signal goes first to the DPLL, which performs the jitter cleaning and most of the frequency translation. Each DPLL features a 30-bit digitally controlled oscillator (DCO) output that generates a signal in the range of 175 MHz to 200 MHz.

The DCO output goes to the APLL, which multiplies the signal up to a range of 2.9 GHz to 4.2 GHz. That signal is then sent to the clock distribution section, which has a divide-by-3 to divide-by-11 P divider cascaded with 10-bit integer channel dividers (divide-by-1 to divide-by-1024).

The XOA and XOB inputs provide the input for the system clock. These bits accept a reference clock in the 10 MHz to 600 MHz range or a 10 MHz to 50 MHz crystal connected directly across the XOA and XOB inputs. The system clock provides the clocks to the frequency monitors, the DPLLs, and internal switching logic.

Each APLL on the AD9559 has two differential output drivers. Each of the four output drivers has a dedicated 10-bit programmable post divider. Each differential driver is programmable as either a single differential or dual single-ended CMOS output. The clock distribution section operates at up to 1250 MHz.

In differential mode, the output drivers run on a 1.8 V power supply to offer very high performance with minimal power consumption. There are two differential modes: LVDS and 1.8 V HSTL. In 1.8 V HSTL mode, the voltage swing is compatible with LVPECL. If LVPECL signal levels are required, the designer can ac-couple the AD9559 output and use Thevenin-equivalent termination at the destination to drive LVPECL inputs.

In single-ended mode, each differential output driver can operate as two single-ended CMOS outputs. OUT0A, $\overline{\text{OUT0A}}$ and OUT1A, $\overline{\text{OUT1A}}$ support only 1.8 V CMOS operation. OUT0B, $\overline{\text{OUT0B}}$ and OUT1B, $\overline{\text{OUT1B}}$ support either 1.8 V or 3.3 V CMOS operation.

REFERENCE INPUT PHYSICAL CONNECTIONS

Four pairs of pins ($\overline{\text{REFA}}$, $\overline{\text{REFA}}$ through $\overline{\text{REFD}}$, $\overline{\text{REFD}}$) provide access to the reference clock receivers. To accommodate input signals with slow rising and falling edges, both the differential and single-ended input receivers employ hysteresis. Hysteresis also ensures that a disconnected or floating input does not cause the receiver to oscillate.

When configured for differential operation, the input receivers accommodate either ac- or dc-coupled input signals. The input receivers are capable of accepting dc-coupled LVDS and 2.5 V and 3.3 V LVPECL signals. The receiver is internally dc biased to handle ac-coupled operation, but there is no internal 50 Ω or 100 Ω termination.

When configured for single-ended operation, the input receivers exhibit a pull-down load of 47 k Ω (typical). Three user-programmable threshold voltage ranges are available for each single-ended receiver. See Register 0x0300 to Register 0x037A for the settings for the reference inputs.

REFERENCE MONITORS

The accuracy of the input reference monitors depends on a known and accurate system clock period. Therefore, the functioning of the reference monitors is not operable until the system clock is stable.

Reference Period Monitor

Each reference input has a dedicated monitor that repeatedly measures the reference period. The AD9559 uses the reference period measurements to determine the validity of the reference based on a set of user-provided parameters in the reference input area of the register map. See Register 0x0304 through Register 0x030E for the settings for Reference A. There are corresponding registers for Reference B, C, and D.

The monitor works by comparing the measured period of a particular reference input with the parameters stored in the profile register assigned to that same reference input. The parameters include the reference period, an inner tolerance, and an outer tolerance. A 40-bit number defines the reference period in units of femtoseconds (fs). The 40-bit range allows for a reference period entry of up to 1.1 ms. A 20-bit number defines the inner and outer tolerances. The value stored in the register is the reciprocal of the tolerance specification. For example, a tolerance specification of 50 ppm yields a register value of $1/(50 \text{ ppm}) = 1/0.000050 = 20,000$ (0x04E20).

The use of two tolerance values provides hysteresis for the monitor decision logic. The inner tolerance applies to a previously faulted reference and specifies the largest period tolerance that a previously faulted reference can exhibit before it qualifies as unfaulted. The outer tolerance applies to an already unfaulted reference. It specifies the largest period tolerance that an unfaulted reference can exhibit before being faulted.

To produce decision hysteresis, the inner tolerance must be less than the outer tolerance. That is, a faulted reference must meet tighter requirements to become unfaulted than an unfaulted reference must meet to become faulted.

Reference Validation Timer

Each reference input has a dedicated validation timer. The validation timer establishes the amount of time that a previously faulted reference must remain unfaulted before the AD9559 declares that it is valid. The timeout period of the validation timer is programmable via a 16-bit register (Address 0x030F and Address 0x0310 for Reference A). The 16-bit number stored in the validation register represents units of milliseconds (ms), which yields a maximum timeout period of 65,535 ms.

It is possible to disable the validation timer by programming the validation timer to 0. With the validation timer disabled, the user must validate a reference manually via the manual reference validation override controls register (Address 0x0A02).

Reference Validation Override Control

The user can also override the reference validation logic, and can either force an invalid reference to be treated as valid, or force a valid reference to be treated as an invalid reference. These controls are in Register 0x0A02 to Register 0x0A03.

REFERENCE INPUT BLOCK

Unlike the AD9557, the AD9559 separates the DPLL reference dividers from the feedback dividers.

The reference input block includes the input receiver, the reference divider (R divider), and the reference input frequency monitor for each reference input. The reference input settings are grouped together in Register 0x0300 to Register 0x037A.

These registers include the following settings:

- Reference logic type (such as differential, single-ended)
- Reference divider (20-bit R divider value)
- Reference input period and tolerance
- Reference validation timer
- Phase and frequency lock detector settings

The reference prescaler reduces the frequency of this signal by an integer factor, $R + 1$, where R is the 20-bit value stored in the appropriate profile register and $0 \leq R \leq 1,048,575$. Therefore, the frequency at the output of the R divider (or the input to the time-to-digital converter, TDC) is as follows:

$$f_{TDC} = \frac{f_R}{R + 1}$$

After the R divider, the signal passes to a 4:2 crosspoint that allows any reference input signal to go to either DPLL.

Each DPLL on the AD9559 has an independent set of feedback dividers for each reference input, and a description of these settings can be found in the Digital PLL (DPLL) Core section.

The [AD9559](#) evaluation software includes a frequency planning wizard that configures the profile parameters, based on the input and output frequencies.

REFERENCE SWITCHOVER

An attractive feature of the [AD9559](#) is its versatile reference switchover capability. The flexibility of the reference switchover functionality resides in a sophisticated prioritization algorithm that is coupled with register-based controls. This scheme provides the user with maximum control over the state machine that handles reference switchover.

The main reference switchover control resides in the user mode registers in the PLL_0/PLL_1 operational controls registers. The reference switching mode bits (Bits[4:2] in Register 0x0A22 for DPLL_0 and Register 0x0A42 for DPLL_1) allow the user to select one of the five operating modes of the reference switchover state machine, as follows:

- Automatic revertive mode
- Automatic nonrevertive mode
- Manual with automatic fallback mode
- Manual with automatic holdover mode
- Full manual mode without holdover

In the automatic modes, a fully automatic priority-based algorithm selects the active reference. When programmed for an automatic mode, the device chooses the highest priority valid reference. When two or more references have the same priority, REFA has preference over REFB, and so on in alphabetical order. However, the reference position is used only as a tiebreaker and does not initiate a reference switch.

The following list gives an overview of the five operating modes:

- Automatic revertive mode. The device selects the highest priority valid reference and switches to a higher priority reference if it becomes available, even if the reference in use is still valid. In this mode, the user reference is ignored.
- Automatic nonrevertive mode. The device stays with the currently selected reference as long as it is valid, even if a higher priority reference becomes available. The user reference is ignored in this mode.
- Manual with automatic fallback mode. The device uses the user reference for as long as it is valid. If it becomes invalid, the reference input with the highest priority is chosen in accordance with the priority-based algorithm.
- Manual with automatic holdover mode. The user reference is the active reference until it becomes invalid. At that point, the device automatically goes into holdover.
- Full manual mode without holdover. The user reference is the active reference, regardless of whether or not it is valid.

The user also has the option to force the device directly into holdover or free run operation via the user holdover and user free run bits. In free run mode, the free run frequency tuning word register defines the free run output frequency. In holdover mode, the output frequency depends on the holdover control settings (see the Holdover section).

Phase Build-Out Reference Switching

The [AD9559](#) supports phase build-out reference switching, which is the term given to a reference switchover that completely masks any phase difference between the previous reference and the new reference. That is, there is virtually no phase change detectable at the output when a phase build-out switchover occurs.

DIGITAL PLL (DPLL) CORE

DPLL Overview

Diagrams of the DPLL cores of the AD9559 (DPLL_0 and DPLL_1) are shown in Figure 35 and Figure 36, respectively. The blocks shown in these diagrams are purely digital.

The start of the DPLL signal chain is the reference signal, f_R , which has been divided by the R divider and then routed through the crosspoint switch to the DPLL. The frequency of this signal, f_{TDC} , is:

$$f_{TDC} = \frac{f_R}{R+1}$$

This is the frequency used by the time-to-digital converter, TDC, inside the DPLL.

A TDC samples the output of the R divider. The TDC/PFD produces a time series of digital words and delivers them to the digital loop filter. The digital loop filter offers the following:

- The determination of the filter response by numeric coefficients rather than by discrete component values
- The absence of analog components (R/L/C), which eliminates tolerance variations due to aging
- The absence of thermal noise associated with analog components
- The absence of control node leakage current associated with analog components (a source of reference feed-through spurs in the output spectrum of a traditional APLL)

The digital loop filter produces a time series of digital words at its output and delivers them to the frequency tuning input of a

sigma-delta (Σ - Δ) modulator. The digital words from the loop filter steer the SDM frequency toward frequency and phase lock with the input signal (f_{TDC}).

Each DPLL includes a feedback divider that causes the digital loop to operate at an integer-plus-fractional multiple. The output of the DPLL is

$$f_{OUT_DPLL} = f_{TDC} \times \left[(N + 1) + \frac{FRAC}{MOD} \right]$$

where N is the 17-bit value stored in the appropriate profile registers (Register 0x0440 to Register 0x044C for DPLL_0 REFA). FRAC and MOD are the 23-bit numerators and denominators of the fractional feedback divider block. The fractional portion of the feedback divider can be bypassed by setting FRAC to 0. MOD can be set to 0, but never change MOD from 0 to nonzero without first entering free run mode.

Note that there are two DPLLs. In the Register Map and Register Map Bit Descriptions sections, N0, FRAC0, and MOD0 are used for DPLL_0; N1, FRAC1, and MOD1 are used for DPLL_1.

For optimal performance, the DPLL output frequency is typically 175 MHz to 200 MHz.

TDC/PFD

The phase frequency detector (PFD) is an all-digital block. It compares the digital output from the TDC (which relates to the active reference edge) with the digital word from the feedback block. It uses a digital code pump and digital integrator (rather than a conventional charge pump and capacitor) to generate the error signal that steers the SDM frequency toward phase lock.

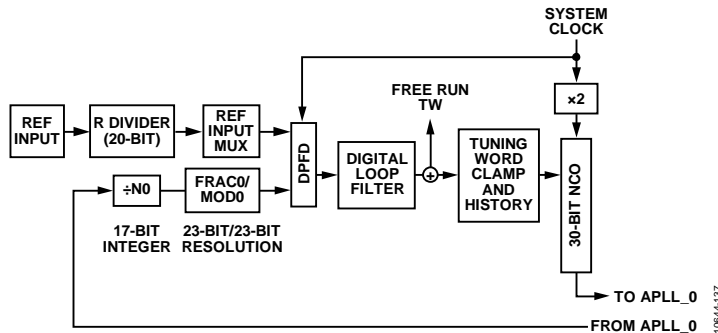

Figure 35. DPLL_0 Core

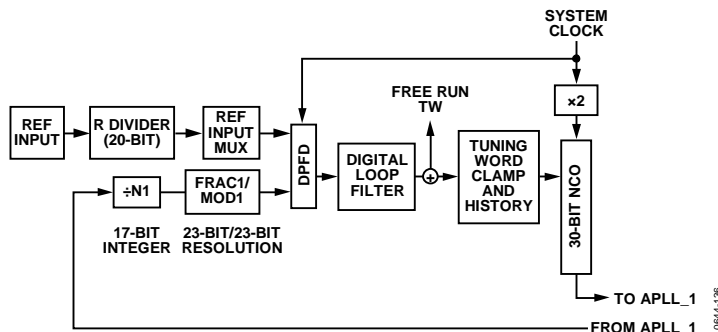

Figure 36. DPLL_1 Core

Programmable Digital Loop Filter

The AD9559 loop filter is a third-order digital IIR filter that is analogous to the third order analog filter shown in Figure 37.

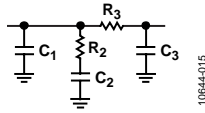

Figure 37. Third Order Analog Loop Filter

The AD9559 has default loop filter coefficients for two DPLL settings: nominal (70°) phase margin, and high (88.5°) phase margin. The high phase margin setting is intended for applications that require <0.1 dB of closed-loop peaking. While these settings do not normally need to be changed, the user can contact Analog Devices, Inc. for a tool to calculate new coefficients to tailor the loop filter to specific requirements.

The AD9559 loop filter block features a simplified architecture in which the user enters the desired loop characteristics (such as loop bandwidth) directly into the DPLL registers. This architecture makes the calculation of individual coefficients unnecessary in most cases, while still offering complete flexibility.

To change a digital loop filter coefficient on a profile that is currently in use, the user must momentarily break the loop for the new setting to take effect. The user can do this by selecting free run or holdover mode, or by invalidating (and then revalidating) the reference input.

DPLL Digitally Controlled Oscillator Free Run Frequency

The AD9559 uses a Σ - Δ modulator as a digitally controlled oscillator (DCO). The DCO free run frequency can be calculated from the following equation:

$$f_{dco_freerun} = f_{sys} \times \frac{2}{8 + \frac{FTW0}{2^{30}}}$$

where $FTW0$ is the value in Register 0x0400 to Register 0x0403 for DPLL_0 (or Register 0x0500 to Register 0x0503 for DPLL_1), and f_{sys} is the system clock frequency. See the System Clock section for information on calculating the system clock frequency.

Adaptive Clocking

The AD9559 can support adaptive clocking applications such as asynchronous mapping and demapping. For these applications, the output frequency can be dynamically adjusted by up to ± 100 ppm from the nominal output frequency without manually breaking the DPLL loop and reprogramming the part.

The following registers are used in this function:

- Register 0x0444 to Register 0x0446 (DPLL N0 divider)
- Register 0x0447 to Register 0x0449 (DPLL FRAC0 divider)
- Register 0x044A to Register 0x044C (DPLL MOD0 divider)

Note that the register values shown are for REFA/DPLL_0. There are corresponding registers for all reference input and DPLL combinations.

Writing to these registers requires an IO_UPDATE by writing 0x01 to Register 0x0005 before the new values take effect.

To make small adjustments to the output frequency, the user can vary the FRAC (FRAC0 or FRAC1) and issue an IO_UPDATE. The advantage to using only FRAC to adjust the output frequency is that the DPLL does not briefly enter holdover. Therefore, the FRAC bit can be updated as quickly as the phase detector frequency of the DPLL.

Writing to the N (N0 or N1) and MOD (M0 or M1) dividers allows for larger changes to the output frequency. When the AD9559 detects a change in the N or MOD value, it automatically enters and exits holdover for a brief instant without any disturbance in the output frequency. This limits how quickly the output frequency can be adapted.

It is important to note that the amount of frequency adjustment is limited to ± 100 ppm before the output PLL (APLL) needs a recalibration. Variations larger than ± 100 ppm are possible, but such variations may compromise the ability of the AD9559 to maintain lock over temperature extremes.

It is also important to remember that the rate of change in output frequency depends on the DPLL loop bandwidth.

DPLL Phase Lock Detector

The DPLL contains an all-digital phase lock detector. The user controls the threshold sensitivity and hysteresis of the phase detector via the profile registers.

The phase lock detector behaves in a manner analogous to water in a tub (see Figure 38). The total capacity of the tub is 4096 units, with -2048 denoting empty, 0 denoting the 50% point, and $+2048$ denoting full. The tub also has a safeguard to prevent overflow. Furthermore, the tub has a low water mark at -1024 and a high water mark at $+1024$. To change the water level, the user adds water with a fill bucket or removes water with a drain bucket. The user specifies the size of the fill and drain buckets via the 8-bit fill rate and drain rate values in the profile registers.

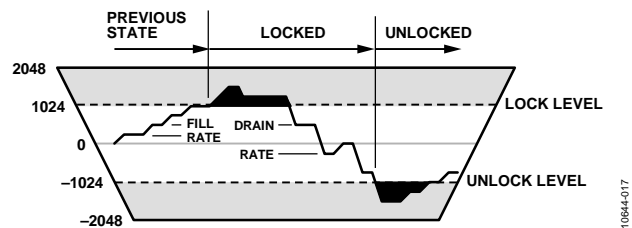

Figure 38. Lock Detector Diagram

The water level in the tub is what the lock detector uses to determine the lock and unlock conditions. When the water level is below the low water mark (-1024), the detector indicates an unlock condition. Conversely, when the water level is above the high water mark ($+1024$), the detector indicates a lock condition. When the water level is between the marks, the detector holds its last condition. This concept appears graphically in Figure 38, with an overlay of an example of the instantaneous water level (vertical) vs. time (horizontal) and the resulting lock/unlock states.

During any given PFD phase error sample, the detector either adds water with the fill bucket or removes water with the drain bucket (one or the other but not both). The decision of whether to add or remove water depends on the threshold level specified by the user. The phase lock threshold value is a 24-bit number stored in the profile registers and is expressed in picoseconds. Thus, the phase lock threshold extends from 0 ns to ± 65.535 ns and represents the magnitude of the phase error at the output of the PFD.

The phase lock detector compares each phase error sample at the output of the PFD to the programmed phase threshold value. If the absolute value of the phase error sample is less than or equal to the programmed phase threshold value, the detector control logic dumps one fill bucket into the tub. Otherwise, it removes one drain bucket from the tub. Note that it is the magnitude, relative to the phase threshold value, that determines whether to fill or drain, and not the polarity of the phase error sample. If more filling is taking place than draining, the water level in the tub eventually rises above the high water mark (+1024), which causes the phase lock detector to indicate lock. If more draining is taking place than filling, the water level in the tub eventually falls below the low water mark (−1024), which causes the phase lock detector to indicate unlock. The ability to specify the threshold level, fill rate, and drain rate enables the user to tailor the operation of the phase lock detector to the statistics of the timing jitter associated with the input reference signal.

Note that whenever the AD9559 enters the free run or holdover mode, the DPLL phase lock detector indicates an unlocked state. However, when the AD9559 performs a reference switch, the state of the lock detector prior to the switch is preserved during the transition period.

DPLL Frequency Lock Detector

The operation of the frequency lock detector is identical to that of the phase lock detector. The only difference is that the fill or drain decision is based on the period deviation between the reference and feedback signals of the DPLL instead of the phase error at the output of the PFD.

The frequency lock detector uses a 24-bit frequency threshold register specified in units of picoseconds. Thus, the frequency threshold value extends from 0 μ s to ± 16.777215 μ s. It represents the magnitude of the difference in period between the reference and feedback signals at the input to the DPLL. For example, if the divided down reference signal is 80 kHz and the feedback signal is 79.32 kHz, the period difference is approximately 75.36 ns ($|1/80,000 - 1/79,320| \approx 107.16$ ns).

Frequency Clamp

The AD9559 digital PLL features a digital tuning word clamp that ensures that the digital PLL output frequency stays within a defined range. This feature is very useful to eliminate undesirable behavior in cases where the reference input clocks may be unpredictable. The tuning word clamp is also useful to guarantee that the APLL never loses lock by ensuring that the APLL VCO frequency stays within its tuning range.

Frequency Tuning Word History

The AD9559 has the ability to track the history of the tuning word samples generated by the DPLL digital loop filter output. It does so by periodically computing the average tuning word value over a user-specified interval. This average tuning word is used during holdover mode to maintain the average frequency when no input references are present.

LOOP CONTROL STATE MACHINE

Switchover

Switchover occurs when the loop controller switches directly from one input reference to another. The AD9559 handles a reference switchover by briefly entering holdover mode, loading the new DPLL parameters, and then immediately recovering. During the switchover event, however, the AD9559 preserves the status of the lock detectors to avoid phantom unlock indications.

Holdover

The holdover state of the DPLL is typically used when none of the input references are present, although the user can also manually engage holdover mode. In holdover mode, the output frequency remains constant. The accuracy of the AD9559 in holdover mode is dependent on the device programming and availability of tuning word history.

Recovery from Holdover

When in holdover and a valid reference becomes available, the device exits holdover operation. The loop state machine restores the DPLL to closed-loop operation, locks to the selected reference, and sequences the recovery of all the loop parameters based on the profile settings for the active reference.

Note that, if the user holdover bit is set, the device does not automatically exit holdover when a valid reference is available. However, automatic recovery can occur after clearing the user holdover bit.

SYSTEM CLOCK (SYSCLK)

SYSCLK INPUTS

Functional Description

The SYSCLK circuit provides a low jitter, stable, high frequency clock for use by the rest of the chip. The XOA and XOB pins connect to the internal SYSCLK multiplier. The SYSCLK multiplier can synthesize the system clock by connecting a crystal resonator across the XOA and XOB input pins or by connecting a low frequency clock source. The optimal signal for the system clock input is either a crystal in the 50 MHz range or an ac-coupled square wave with a 1 V p-p amplitude.

SYSCLK Period

For the AD9559 to accurately measure the frequency of incoming reference signals, the user must enter the system clock period into the nominal system clock period registers (Register 0x0202 to Register 0x0204). The SYSCLK period is entered in units of femtoseconds (fs).

Choosing the SYSCLK Source

There are two internal paths for the SYSCLK input signal: low frequency non-XTAL (LF) and crystal resonator (XTAL).

Using a TCXO for the system clock is a common use for the LF path. Applications requiring DPLL loop bandwidths of less than 50 Hz or high stability in holdover require a TCXO or OCXO. As an alternative to the 49.152 MHz crystal for these applications, the AD9559 reference design uses a 19.2 MHz TCXO, which offers excellent holdover stability and a good combination of low jitter and low spurious content.

The 1.8 V differential receiver connected to the XOA and XOB pins is self-biased to a dc level of ~1 V, and ac coupling is strongly recommended to maintain a 50% input duty cycle. When a 3.3 V CMOS oscillator is in use, it is important to use a voltage divider to reduce the input high voltage to a maximum of 1.8 V. See Figure 33 for details on connecting a 3.3 V CMOS TCXO to the system clock input.

The non-XTAL) input path permits the user to provide an LVPECL, LVDS, 1.8 V CMOS, or sinusoidal low frequency clock for multiplication by the integrated SYSCLK PLL. The LF path handles input frequencies from 10 MHz up to 100 MHz. However, when using a sinusoidal input signal, it is best to use a frequency of ≥ 20 MHz. Otherwise, the resulting low slew rate can lead to poor noise performance. Note that there is an optional $2\times$ frequency multiplier to double the rate at the input to the SYSCLK PLL and potentially reduce the PLL in-band noise. However, to avoid exceeding the maximum PFD rate of 150 MHz, the $2\times$ frequency multiplier is only for input frequencies that are below 75 MHz.

The non-XTAL) path also includes an input divider (M) that is programmable for divide-by-1, -2, -4, or -8. The purpose of the divider is to limit the frequency at the input to the PLLs to less than 150 MHz (the maximum PFD rate).

The XTAL path enables the connection of a crystal resonator (typically 10 MHz to 50 MHz) across the XOA and XOB pins. An internal amplifier provides the negative resistance required to induce oscillation. The internal amplifier expects an AT cut, fundamental mode crystal with a maximum motional resistance of 100 Ω . The following crystals, listed in alphabetical order, may meet these criteria. Analog Devices does not guarantee their operation with the AD9559, nor does Analog Devices endorse one crystal supplier over another. The AD9559 reference design uses a 49.152 MHz crystal, which is high performance, low spurious content, and readily available.

- AVX/Kyocera CX3225SB
- ECS ECX-32
- Epson/Toyocom TSX-3225
- Fox FX3225BS
- NDK NX3225SA
- Siward SX-3225
- Suntu SCM10B48-49.152 MHz

SYSCLK MULTIPLIER

The SYSCLK PLL multiplier is an integer-N design with an integrated VCO. It provides a means to convert a low frequency clock input to the desired system clock frequency, f_{sys} (750 MHz to 805 MHz). The SYSCLK PLL multiplier accepts input signals of between 10 MHz and 400 MHz, but frequencies that are in excess of 150 MHz require the J1 divider of the system clock to ensure compliance with the maximum PFD rate (150 MHz). The PLL contains a feedback divider (K) that is programmable for divide values between 4 and 255.

$$f_{sys} = f_{osc} \times \frac{sysclk_Kdiv}{sysclk_Jdiv}$$

where:

f_{osc} is the frequency at the XOA and XOB pins.

$sysclk_Kdiv$ is the value stored in Register 0x0200.

$sysclk_Jdiv$ is the system clock J1 divider that is determined by the setting of Register 0x0201[2:1].

If the system clock doubler is used, the value of $sysclk_Kdiv$ should be half of its original value.

The system clock multiplier features a simple lock detector that compares the time difference between the reference and feedback edges. The most common cause of the SYSCLK multiplier not locking is a non-50% duty cycle at the SYSCLK input while the system clock doubler is enabled.

System Clock Stability Timer

Because the reference monitors depend on the system clock being at a known frequency, it is important that the system clock be stable before activating the monitors. At initial power-up, the system clock status is not known; therefore, it is reported as being unstable. After the part has been programmed, the system clock PLL eventually locks.

When a stable operating condition is detected, a timer is run for the duration that is stored in the system clock stability period registers. If, at any time during this waiting period, the condition is violated, the timer is reset and halted until a stable condition is reestablished. After the specified period elapses, the [AD9559](#) reports the system clock as stable.

Note that, any time the system clock stability timer is changed in Register 0x0205 through Register 0x0207, it is reset automatically. The system clock stability timer starts counting when the next IO_UPDATE is issued.

OUTPUT PLL (APLL)

There are two output PLLs (APLLs) on the AD9559. They provide the frequency upconversion from the digital PLL (DPLL) outputs. The frequency range is 2940 MHz to 3543 MHz for the APLL_0 and 3405 MHz to 4260 MHz for the APLL_1, while also providing noise filter on the DPLL output. The APLL reference input is the output of the DPLL. The feedback divider is an integer divider. The loop filter is partially integrated with the one external 6.8 nF capacitor that connects to an internal LDO. The nominal loop bandwidth for both of the APLLs is 240 kHz. The APLL_0 and APLL_1 block diagrams are shown in Figure 39 and Figure 40, respectively.

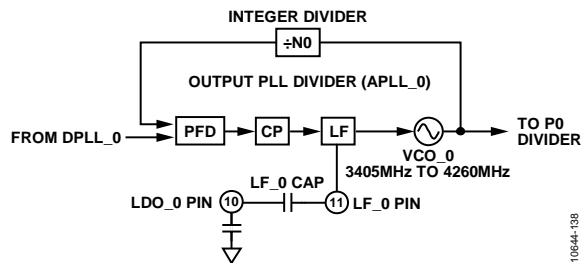

Figure 39. APLL_0 Block Diagram

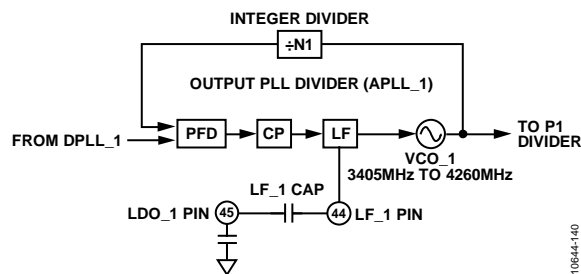

Figure 40. APLL_1 Block Diagram

APLL CONFIGURATION

The frequency wizard that is included in the evaluation software configures the APLL, and the user should not need to make changes to the APLL settings. However, there may be special cases where the user may wish to adjust the APLL loop bandwidth to meet a specific phase noise requirement. The easiest way to change the APLL loop bandwidth is to adjust the APLL charge pump current in Register 0x0420 (APLL_0) or Register 0x0520 (APLL_1).

There is sufficient stability (68° of phase margin) in the APLL default settings to permit a broad range of adjustment without causing the APLL to be unstable. The user should contact Analog Devices directly if more information is needed.

APLL CALIBRATION

Calibration of the APLLs must be performed at startup and whenever the nominal input frequency to the APLL changes by more than ± 100 ppm, although the APLL maintains lock over voltage and temperature extremes without recalibration. Calibration centers the dc operating voltage at the input to the APLL VCO.

APLL calibration at startup is normally performed during initial register loading by following the instructions in the Device Register Programming Using a Register Setup File section of this datasheet.

To recalibrate the APLL VCO after the chip has been running, first input the new settings (if any). Ensure that the system clock is still locked and stable, and that the DPLL is in free run mode with the free run tuning word set to the same output frequency that is used when the DPLL is locked. The user can calibrate APLL_0 without disturbing APLL_1 and vice versa.

Use the following steps to recalibrate the APLL VCO. Important: An IO_UPDATE (Register 0x0005 = 0x01) is needed after each of these steps.

1. Ensure that the system clock is locked and stable. (Register 0x0D01[1] = 1b).
2. Ensure that the DPLL free run tuning word is set.
DPLL_0: Register 0x0400 to Register 0x0403
DPLL_1: Register 0x0500 to Register 0x0503
3. Set free run mode for the appropriate DPLL.
DPLL_0: Register 0x0A22[0] = 1b
DPLL_1: Register 0x0A42[0] = 1b
4. Clear APLL calibration bit.
APLL_0: Register 0x0A20 = 0x00
APLL_1: Register 0x0A40 = 0x00
5. Set APLL calibration bit.
APLL_0: Register 0x0A20 = 0x02
APLL_1: Register 0x0A40 = 0x02
6. Poll the APLL lock status.
APLL_0: Register 0x0D20[3] = 1b indicates lock.
APLL_1: Register 0x0D40[3] = 1b indicates lock.
7. Clear the DPLL mode for the appropriate DPLL.
DPLL_0: Register 0x0A22[0] = 0b
DPLL_1: Register 0x0A42[0] = 0b

CLOCK DISTRIBUTION

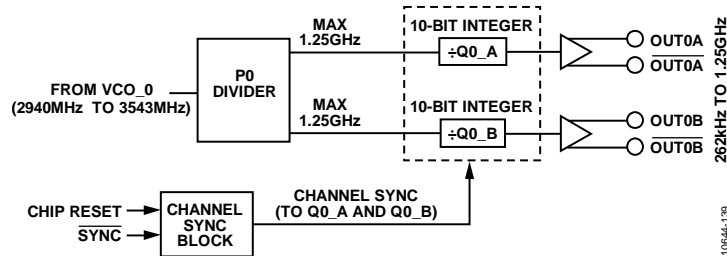

Figure 41. Clock Distribution Block Diagram from VCO_0

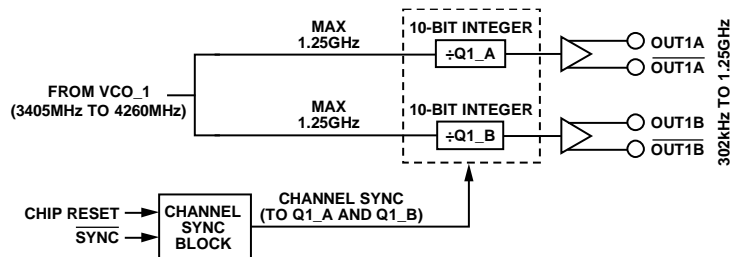

Figure 42. Clock Distribution Block Diagram from VCO_1

The AD9559 has two identical clock distribution sections: one for PLL_0 from VCO_0 and the other for PLL_1. See Figure 41 for a diagram of the clock distribution block for PLL_0 and Figure 42 for the PLL_1 block.

CLOCK DIVIDERS

P0 and P1 Dividers

The first block in each clock distribution section is the P divider. The P divider divides the VCO output frequency down to a maximum frequency of ≤ 1.25 GHz and has special circuitry to maintain a 50% duty cycle for any divide ratio.

The following register addresses contain the P divider settings:

- PLL_0, P0 divider: Register 0x0424[3:0]
- PLL_1, P1 divider: Register 0x0524[3:0]

Channel Dividers

The channel divider blocks, Q0_A, Q0_B, Q1_B, and Q1_A, are 10-bit integer dividers with a divide range of 1 to 1024. The channel divider block contains duty cycle correction that guarantees 50% duty cycle for both even and odd divide ratios. The maximum input frequency to the channel dividers is 1.25 GHz.

The channel dividers are at the following register addresses:

- Q0_A divider: Register 0x0428 to Register 0x042A
- Q0_B divider: Register 0x042C to Register 0x042E
- Q1_A divider: Register 0x0528 to Register 0x052A
- Q1_B divider: Register 0x052C to Register 0x052E

OUTPUT ENABLE

Each of the output channels offers independent control of enable/disable functionality via the distribution enable register. The distribution outputs use synchronization logic to control enable/disable activity to avoid the production of runt pulses and to ensure that outputs with the same divide ratios become active/inactive in unison.

OUTPUT MODE AND POWER-DOWN

The output drivers can be individually powered down. The output mode control (including power-down) can be found at the following register addresses:

- OUT0A: Register 0x0427[6:4]
- OUT0B: Register 0x042B[7:4]
- OUT1A: Register 0x0527[6:4]
- OUT1B: Register 0x052B[7:4]

The operating mode control includes

- Logic type and pin function
- Output drive strength
- Output polarity
- Divide ratio
- Phase of each output channel

OUT0B and OUT1B provide the 3.3 V CMOS, 1.8 V CMOS, LVDS, and HSTL modes.

OUT0A and OUT1A provide the 1.8 V CMOS, LVDS, and HSTL modes.

The 3.3 V CMOS drivers feature a CMOS drive strength that allows the user to choose between a strong, high performance CMOS driver or a lower power setting with less EMI and crosstalk. The best setting is application dependent.

- All outputs have an LVDS boost mode that provides increased output amplitude in applications that require it.
- For applications where LVPECL levels are required, the user should choose the HSTL mode and then ac-couple the output signal. See the Input/Output Termination Recommendations section for recommended termination schemes.

CLOCK DISTRIBUTION SYNCHRONIZATION

Divider Synchronization

The dividers in the channels can be synchronized with each other. At power-up, they are held static until a sync signal is initiated through serial port, EEPROM event, DPLL locked sync, or

a reference edge-initiated sync. This provides time for programming the dividers and for the DPLL to lock before the outputs are enabled. A user-initiated sync signal can also be supplied to the dividers at any time (as a manual synchronization) using an M pin.

A channel can be programmed to ignore the sync function. When programmed to ignore the sync, the channel sync block issues a sync pulse immediately, and the channel ignores all other sync signals.

The digital logic triggers a sync event from one of the following sources:

- Register programming through serial port
- EEPROM programming
- A multifunction pin configured for the SYNC signal
- Other automatic conditions determined by the DPLL configuration: DPLL lock or feedback divider pulse

STATUS AND CONTROL

MULTIFUNCTION PINS (M0 TO M5)

The AD9559 has six digital CMOS I/O pins (M0 to M5) that are configurable for a variety of uses. To use these functions, the user must set them by writing to Register 0x0100 and Register 0x0101. The function of these pins is programmable via the register map. Each pin can control or monitor an assortment of internal functions based on Register 0x0102 to Register 0x0107.

The M pins feature a special write detection logic that prevents them from behaving unpredictably when their function changes. When the user writes to these registers, the existing M pin function stops. The new M pin function takes effect on the next IO_UPDATE (Register 0x0005 = 0x01).

The M4 and M5 pins are multiplexed with serial port functions. For the M4/SDO pin to function as M4, the AD9559 must not be in 4-wire SPI mode. For the M5/ $\overline{\text{CS}}$ pin to function as M5, either I²C or 2-wire SPI mode must be in use.

The M pins operate in one of four modes: active high CMOS, active low CMOS, open-drain PMOS, and open-drain NMOS.

00—Active high CMOS: The M pin is Logic 0 when deasserted and Logic 1 when asserted. This is the default operating mode.

01—Active low CMOS: The M pin is Logic 1 when deasserted and Logic 0 when asserted.

10—Open-drain PMOS: The M pin is high impedance when deasserted and active high when asserted; it requires an external pull-down resistor.

11—Open-drain NMOS: The M pin is high impedance when deasserted and active low when asserted; it requires an external pull-up resistor.

To monitor an internal function with a multifunction pin, write a Logic 1 to the most significant bit of the register associated with the desired multifunction pin. The value of the seven least significant bits of the register defines the control function, as shown in Table 196.

To control an internal function with a multifunction pin, write a Logic 0 to the most significant bit of the register associated with the desired multifunction pin. The monitored function depends on the value of the seven least significant bits of the register, as shown in Table 197.

If more than one multifunction pin operates on the same control signal, internal priority logic ensures that only one multifunction pin serves as the signal source. The selected pin is the one with the lowest numeric suffix. For example, if both M0 and M3 operate on the same control signal, M0 is used as the signal source and the redundant pins are ignored.

At power-up, the multifunction pins can force the device into certain configurations as defined in the Multifunction Pins at Reset/Power-Up section. This behavior is valid only during power-up or following a reset, after which the pins can be reconfigured via the serial programming port or via the EEPROM.

IRQ FUNCTION

The AD9559 IRQ function can be assigned to any M pin. There are three IRQ categories: PLL0, PLL1, and common. This means an M pin can be set to respond only to IRQs that relate to PLL0, PLL1, or to common functions. An M pin can also be set to respond to all IRQs.

The AD9559 asserts the IRQ pin when any bit in the IRQ monitor register (Address 0x0D08 to Address 0x0D10) is a Logic 1. Each bit in this register is associated with an internal function that is capable of producing an interrupt. Furthermore, each bit of the IRQ monitor register is the result of a logical AND of the associated internal interrupt signal and the corresponding bit in the IRQ mask register (Address 0x010A to Address 0x0112). That is, the bits in the IRQ mask register have a one-to-one correspondence with the bits in the IRQ monitor register. When an internal function produces an interrupt signal and the associated IRQ mask bit is set, the corresponding bit in the IRQ monitor register is set. Be aware that clearing a bit in the IRQ mask register removes only the mask associated with the internal interrupt signal. It does not clear the corresponding bit in the IRQ monitor register.

The IRQ function is edge-triggered. This means that if the condition that generated an IRQ (for example, loss of DPLL_0 lock) still exists after an IRQ is cleared, the IRQ does not reactivate until DPLL_0 lock is restored and lost again. However, if the IRQs are enabled when DPLL_0 is not locked, an IRQ is generated.

The IRQ function of an M pin is the result of a logical OR of all the IRQ monitor register bits. The AD9559 asserts an IRQ as long as any of the IRQ monitor register bits is a Logic 1. Note that it is possible to have multiple bits set in the IRQ monitor register. Therefore, when the AD9559 asserts an IRQ, it may indicate an interrupt from several different internal functions. The IRQ monitor register provides a way to interrogate the AD9559 to determine which internal function(s) produced the interrupt.

Typically, when the AD9559 asserts an IRQ, the user interrogates the IRQ monitor register to identify the source of the interrupt request. After servicing an indicated interrupt, the user should clear the associated IRQ monitor register bit via the IRQ clearing register (Address 0x0A05 to Address 0x0A0E). The bits in the IRQ clearing register have a one-to-one correspondence with the bits in the IRQ monitor register.

Note that the IRQ clearing registers are autoclearing. The M pin associated with an IRQ remains asserted until the user clears all of the bits in the IRQ monitor register that indicate an interrupt.

All IRQ monitor register bits can be cleared by setting the clear all IRQs bit in the IRQ register (Register 0x0A05). Note that the bits in Register 0x0A05 are autoclearing. Setting Bit 0 results in the deassertion of all IRQs. Alternatively, the user can program any of the multifunction pins to clear all IRQs, which allows the user to clear all IRQs by means of a hardware pin rather than by a serial I/O port operation.

WATCHDOG TIMER

The watchdog timer is a general-purpose programmable timer. To set the timeout period, the user writes to the 16-bit watchdog timer register (Address 0x0108 to Address 0x0109). A value of 0x0000 in this register disables the timer. A nonzero value sets the timeout period in milliseconds, giving the watchdog timer a range of 1 ms to 65.535 sec. The relative accuracy of the timer is approximately 0.1% with an uncertainty of 0.5 ms.

If enabled, the timer runs continuously and generates a timeout event when the timeout period expires. The user has access to the watchdog timer status via the IRQ mechanism and the multifunction pins (M0 to M3). The M4 and M5 multifunction pins are available if they are not used for the serial port. In the case of the multifunction pins, the timeout event of the watchdog timer is a pulse that lasts 32 system clock periods.

There are two ways to reset the watchdog timer (thereby preventing it from causing a timeout event). The first method is to write a Logic 1 to the autoclearing clear watchdog timer bit in the clear IRQ groups register (Register 0x0A05, Bit 7). Alternatively, the user can program any of the multifunction pins to reset the watchdog timer. This allows the user to reset the timer by means of a hardware pin rather than by a serial I/O port operation.

EEPROM

EEPROM Overview

The AD9559 contains an integrated 2048-byte, electrically erasable, programmable read-only memory (EEPROM). The AD9559 can be configured to perform a download at power-up via the multifunction pins (M1 and M0), but uploads and downloads can also be performed on demand via the EEPROM control registers (Address 0x0E00 to Address 0x0E03).

The EEPROM provides the ability to upload and download configuration settings to and from the register map. Figure 43 shows a functional diagram of the EEPROM.

Register 0x0E10 to Register 0x0E4F represent a 64-byte EEPROM storage sequence area (referred to as the scratchpad in this section) that enables the user to store a sequence of instructions for transferring data to the EEPROM from the device settings portion of the register map. Note that the default values for these registers provide a sample sequence for saving/retrieving all of the AD9559 EEPROM-accessible registers. Figure 43 shows the connectivity between the EEPROM and the controller that manages data transfer between the EEPROM and the register map.

The controller oversees the process of transferring EEPROM data to and from the register map. There are two modes of operation handled by the controller: saving data to the EEPROM (upload mode) or retrieving data from the EEPROM (download mode). In either case, the controller relies on a specific instruction set.

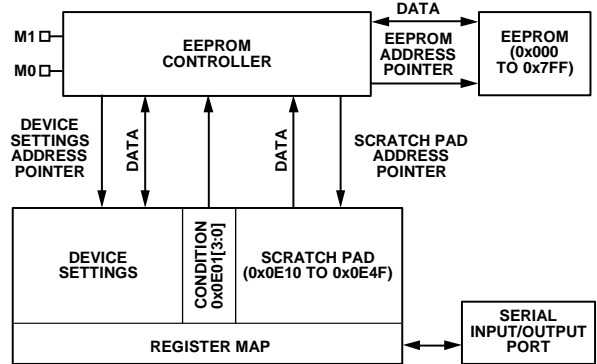

Figure 43. EEPROM Functional Diagram

EEPROM Instructions

Table 22 lists the EEPROM controller instruction set. The controller recognizes all instruction types whether it is in upload or download mode, except for the pause instruction, which is only recognized in upload mode.

The IO_UPDATE, calibrate, distribution sync, and end instructions are, for the most part, self-explanatory. The others, however, warrant further detail, as described in the following paragraphs.

Data instructions are those that have a value from 0x00 to 0x7F. A data instruction tells the controller to transfer data between the EEPROM and the register map. The controller needs the following two parameters to carry out the data transfer:

- The number of bytes to transfer
- The register map target address

Table 22. EEPROM Controller Instruction Set

| Instruction Value (Hex) | Instruction Type | Bytes Needed | Description |
|-------------------------|------------------------------------|--------------|--|
| 0x00 to 0x7F | Data | 3 | A data instruction tells the controller to transfer data to or from the device settings part of the register map. A data instruction requires two additional bytes that, together, indicate a starting address in the register map. Encoded in the data instruction is the number of bytes to transfer, which is one more than the instruction value. |
| 0x80 | IO_UPDATE | 1 | The controller issues a soft IO_UPDATE (which is analogous to the user writing Register 0x0005 = 0x01). |
| 0x90 | Calibrate both APLLs | 1 | The controller initiates an APLL calibration sequence to both APLL_0 and APLL_1 while downloading from the EEPROM. APLL calibration is gated by the system clock being stable. |
| 0x91 | Calibrate APLL_0 | 1 | When the controller encounters this instruction while downloading from the EEPROM, it initiates an APLL_0 calibration sequence. APLL calibration is gated by the system clock being stable. |
| 0x92 | Calibrate APLL_1 | 1 | When the controller encounters this instruction while downloading from the EEPROM, it initiates an APLL_1 calibration sequence. APLL calibration is gated by the system clock being stable. |
| 0x98 | Set User Free run Mode (both PLLs) | 1 | When the controller encounters this instruction while downloading from the EEPROM, it forces both of the DPLLs into user free run mode. |
| 0x99 | Set User Free run Mode (DPLL_0) | 1 | When the controller encounters this instruction while downloading from the EEPROM, it forces both of the DPLLs into user free run mode. |
| 0x9A | Set User Free run Mode (DPLL_1) | 1 | When the controller encounters this instruction while downloading from the EEPROM, it forces both of the DPLLs into user free run mode. |
| 0xA0 | Distribution sync (all outputs) | 1 | When the controller encounters this instruction while downloading from the EEPROM, it issues a sync pulse to the PLL0 and PLL1 channel dividers. Note that the APLL_0 must be locked before the sync pulse reaches the PLL_0 channel dividers, and APLL_1 must be locked before the sync pulse reaches the PLL_1 channel dividers, unless overridden. |
| 0xA1 | Distribution sync (PLL0 outputs) | 1 | When the controller encounters this instruction while downloading from the EEPROM, it issues a sync pulse to the PLL_0 channel dividers. Note that, unless overridden, this sync pulse is gated by the APLL_0 lock detect signal. |
| 0xA2 | Distribution sync (PLL1 outputs) | 1 | When the controller encounters this instruction while downloading from the EEPROM, it issues a sync pulse to the PLL1 channel dividers. Note that, unless overridden, this sync pulse is gated by the APLL_1 lock detect signal. |
| 0xB0 | Clear condition | 1 | 0xB0 is the null condition instruction (see the EEPROM Conditional Processing section). |
| 0xB1 to 0xBF | Condition | 1 | 0xB1 to 0xBF are condition instructions and correspond to Condition 1 through Condition 15, respectively (see the EEPROM Conditional Processing section). |
| 0xFE | Pause | 1 | When the controller encounters this instruction in the scratchpad while uploading to the EEPROM, it resets the scratchpad address pointer and holds the EEPROM address pointer at its last value. This allows storage of more than one instruction sequence in the EEPROM. Note that the controller does not copy this instruction to the EEPROM during upload. |
| 0xFF | End of data | 1 | When the controller encounters this instruction in the scratchpad while uploading to the EEPROM, it resets both the scratchpad address pointer and the EEPROM address pointer and then enters an idle state. When the controller encounters this instruction while downloading from the EEPROM, it resets the EEPROM address pointer and then enters an idle state. |

The controller decodes the number of bytes to transfer directly from the data instruction itself by adding 1 to the value of the instruction. For example, Data Instruction 0x1A has a decimal value of 26; therefore, the controller knows to transfer 27 bytes (one more than the value of the instruction). When the controller encounters a data instruction, it knows to read the next two bytes in the scratchpad because these contain the register map target address.

Note that, in the EEPROM scratchpad, the two registers that comprise the address portion of a data instruction have the MSB of the address in the D7 position of the lower register address. The bit weight increases left to right, from the lower register address to the higher register address. Furthermore, the starting address always indicates the lowest numbered register map address in the range of bytes to transfer. That is, the controller always starts at the register map target address and counts upward, regardless of whether the serial I/O port is operating in I²C, SPI LSB-first, or SPI MSB-first mode.

As part of the data transfer process during an EEPROM upload, the controller calculates a 1-byte checksum and stores it as the final byte of the data transfer. As part of the data transfer process during an EEPROM download, however, the controller again calculates a 1-byte checksum value but compares the newly calculated checksum with the one that was stored during the upload process. If an upload/download checksum pair does not match, the controller sets the EEPROM fault status bit. If the upload/download checksums match for all data instructions encountered during a download sequence, the controller sets the EEPROM complete status bit.

Condition instructions are those that have a value from 0xB0 to 0xBF. The 0xB1 to 0xBF condition instructions represent Condition 1 to Condition 15, respectively. The 0xB0 condition instruction is special because it represents the null condition (see the EEPROM Conditional Processing section).

A pause instruction, like an end instruction, is stored at the end of a sequence of instructions in the scratchpad. When the controller encounters a pause instruction during an upload sequence, it keeps the EEPROM address pointer at its last value. Then the user can store a new instruction sequence in the scratchpad and upload the new sequence to the EEPROM. The new sequence is stored in the EEPROM address locations immediately following the previously saved sequence. This process is repeatable until an upload sequence contains an end instruction. The pause instruction is also useful when used in conjunction with condition processing. It allows the EEPROM to contain multiple occurrences of the same registers, with each occurrence linked to a set of conditions (see the EEPROM Conditional Processing section).

EEPROM Upload

To upload data to the EEPROM, the user must first ensure that the write enable bit (Register 0x0E00, Bit 0) is set. Then, on setting the autoclearing save to EEPROM bit (Register 0x0E02, Bit 0), the controller initiates the EEPROM data storage process. Once an EEPROM save/load transfer is complete, the user should wait a

minimum of 10 μ s before starting the next EEPROM save/load transfer.

Uploading EEPROM data requires the user to first write an instruction sequence into the scratchpad registers. During the upload process, the controller reads the scratchpad data byte-by-byte, starting at Register 0x0E10 and incrementing the scratchpad address pointer, as it goes, until it reaches a pause or end instruction.

As the controller reads the scratchpad data, it transfers the data from the scratchpad to the EEPROM (byte-by-byte) and increments the EEPROM address pointer accordingly, unless it encounters a data instruction. A data instruction tells the controller to transfer data from the device settings portion of the register map to the EEPROM. The number of bytes to transfer is encoded within the data instruction, and the starting address for the transfer appears in the next two bytes in the scratchpad.

When the controller encounters a data instruction, it stores the instruction in the EEPROM, increments the EEPROM address pointer, decodes the number of bytes to be transferred, and increments the scratchpad address pointer. Then it retrieves the next two bytes from the scratchpad (the target address) and increments the scratchpad address pointer by 2. Next, the controller transfers the specified number of bytes from the register map (beginning at the target address) to the EEPROM.

When it completes the data transfer, the controller stores an extra byte in the EEPROM to serve as a checksum for the transferred block of data. To account for the checksum byte, the controller increments the EEPROM address pointer by one more than the number of bytes transferred. Note that, when the controller transfers data associated with an active register, it actually transfers the buffered contents of the register (refer to the Buffered/Active Registers section for details on the difference between buffered and active registers). This allows for the transfer of nonzero autoclearing register contents.

Note that conditional processing (see the EEPROM Conditional Processing section) does not occur during an upload sequence.

Manual EEPROM Download

An EEPROM download results in data transfer from the EEPROM to the device register map. To download data, the user sets the autoclearing load from EEPROM bit (Register 0x0E03, Bit 1). This commands the controller to initiate the EEPROM download process. During download, the controller reads the EEPROM data byte by byte, incrementing the EEPROM address pointer as it goes, until it reaches an end instruction. As the controller reads the EEPROM data, it executes the stored instructions, which includes transferring stored data to the device settings portion of the register map whenever it encounters a data instruction. Once an EEPROM save/load transfer is complete, the user should wait a minimum of 10 μ s before starting the next EEPROM save/load transfer.

Note that conditional processing (see the EEPROM Conditional Processing section) is applicable only when downloading.

Automatic EEPROM Download

Following a power-up, an assertion of the RESET pin, or a soft reset (Register 0x0000, Bit 5 = 1), if either the M1 pin or M0 pin is high (see Table 23), the instruction sequence stored in the EEPROM executes automatically with one of three conditions. If M1 and M0 are low, the EEPROM is bypassed and the factory defaults are used. In this way, a previously stored set of register values downloads automatically on power-up or with a hard or soft reset. See the EEPROM Conditional Processing section for details regarding conditional processing and the way it modifies the download process.

Table 23. EEPROM Download M Pin Setup

| M1 | M0 | ID | EEPROM Download |
|----|----|----|-------------------------|
| 0 | 0 | 0 | No |
| 0 | 1 | 1 | Yes, EEPROM Condition 1 |
| 1 | 0 | 2 | Yes, EEPROM Condition 2 |
| 1 | 1 | 3 | Yes, EEPROM Condition 3 |

EEPROM Conditional Processing

The condition instructions allow conditional execution of EEPROM instructions during a download sequence. During an upload sequence, however, they are stored as is and have no effect on the upload process.

Note that, during EEPROM downloads, the condition instructions themselves and the end instruction always execute unconditionally.

Conditional processing makes use of two elements: the condition (from Condition 1 to Condition 15) and the condition tag board. The relationships among the condition, the condition tag board, and the EEPROM controller appear schematically in Figure 44.

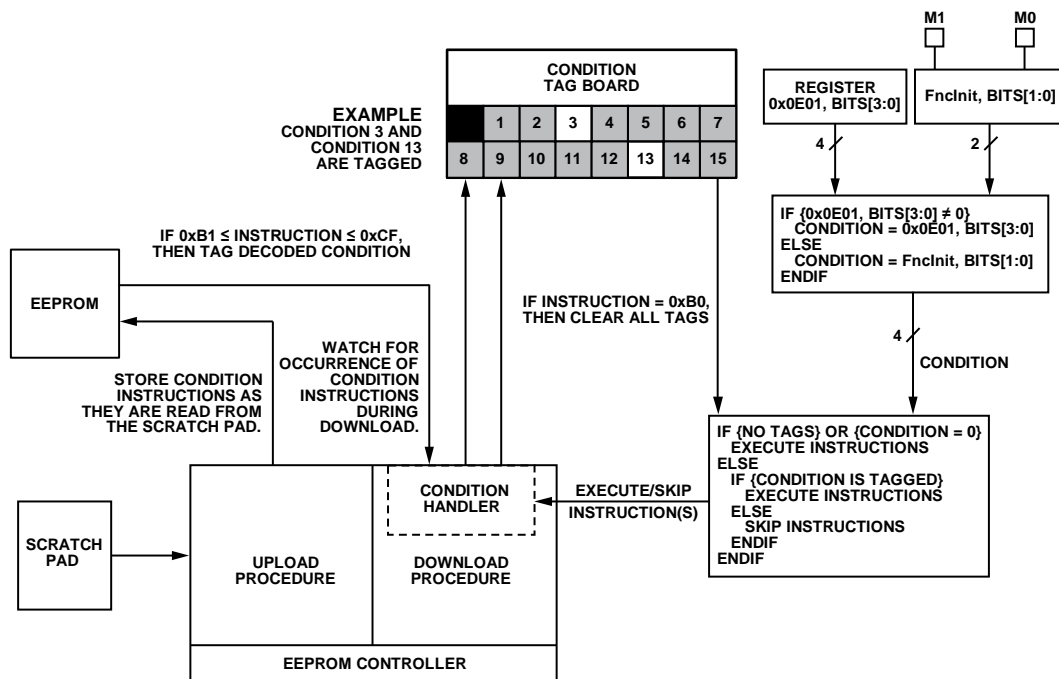

Figure 44. EEPROM Conditional Processing

10644-025

The condition is a 4-bit value with 16 possibilities. Condition = 0 is the null condition. When the null condition is in effect, the EEPROM controller executes all instructions unconditionally. The remaining 15 possibilities, condition = 1 through condition = 15, modify the EEPROM controller's handling of a download sequence. The condition originates from one of two sources (see Figure 44), as follows:

- FncInit, Bits[1:0], which is the state of the M1 and M0 multifunction pins at power-up (see Table 23) (Note that only Condition 1 through Condition 3 are accessible via the M pins.)
- Register 0x0E01, Bits[3:0]

If Register 0x0E01, Bits[3:0] \neq 0, then the condition is the value stored in Register 0x0E01, Bits[3:0]; otherwise, the condition is FncInit, Bits[1:0]. Note that a nonzero condition present in Register 0x0E01, Bits[3:0], takes precedence over FncInit, Bits[1:0].

The condition tag board is a table that is maintained by the EEPROM controller. When the controller encounters a condition instruction, it decodes the 0xB1 through 0xBF instructions as condition = 1 through condition = 15, respectively, and tags that particular condition in the condition tag board. However, the 0xB0 condition instruction decodes as the null condition, for which the controller clears the condition tag board, and subsequent download instructions execute unconditionally (until the controller encounters a new condition instruction).

During download, the EEPROM controller executes or skips instructions depending on the value of the condition and the contents of the condition tag board. Note, however, that condition instructions and the end instruction always execute unconditionally during download. If condition = 0, then all instructions during download execute unconditionally. If condition \neq 0 and there are any tagged conditions in the condition tag board, then the controller executes instructions only if the condition is tagged. If the condition is not tagged, then the controller skips instructions until it encounters a condition instruction that decodes as a tagged condition. Note that the condition tag board allows for multiple conditions to be tagged at any given moment. This conditional processing mechanism enables the user to have one download instruction sequence with many possible outcomes depending on the value of the condition and the order in which the controller encounters condition instructions.

Table 24 lists a sample EEPROM download instruction sequence. It illustrates the use of condition instructions and how they alter the download sequence. The table begins with the assumption that no conditions are in effect. That is, the most recently executed condition instruction is 0xB0 or no conditional instructions have been processed.

Table 24. EEPROM Conditional Processing Example

| Instruction | Action |
|------------------------|---|
| 0x08, 0x01, 0x00 | Transfer the system clock register contents regardless of the current condition. |
| 0xB1 | Tag Condition 1 |
| 0x19, 0x04, 0x00 | Transfer the clock distribution register contents only if tag condition = 1 |
| 0xB2 | Tag Condition 2 |
| 0xB3 | Tag Condition 3 |
| 0x07, 0x05, 0x00 | Transfer the reference input register contents only if tag condition = 1, 2, or 3 |
| 0x0A | Calibrate the system clock only if tag condition = 1, 2, or 3 |
| 0xB0 | Clear the tag condition tag board |
| 0x80 | Execute an IO_UPDATE, regardless of the value of the tag condition |
| 0x0A | Calibrate the system clock regardless of the value of the tag condition |

Storing Multiple Device Setups in EEPROM

Conditional processing makes it possible to create a number of different device setups, store them in EEPROM, and download a specific setup on demand. To do so, first program the device control registers for a specific setup. Then, store an upload sequence in the EEPROM scratchpad with the following general form:

1. Condition instruction (0xB1 to 0xBF) to identify the setup with a specific condition (1 to 15)
2. Data instructions (to save the register contents) along with any required calibrate and/or IO_UPDATE instructions
3. Pause instruction (0xFE)

With the upload sequence written to the scratchpad, set the write enable bit (Register 0x0E00, Bit 0) and perform an EEPROM upload (Register 0x0E02, Bit 0).

Reprogram the device control registers for the next desired setup. Then store a new upload sequence in the EEPROM scratchpad with the following general form:

1. Condition instruction (0xB0)
2. The next desired condition instruction (0xB1 to 0xBF, but different from the one used during the previous upload to identify a new setup)
3. Data instructions (to save the register contents) along with any required calibrate and/or IO_UPDATE instructions
4. Pause instruction (0xFE)

With the upload sequence written to the scratchpad, perform an EEPROM upload (Register 0x0E02, Bit 0).

Repeat the process of programming the device control registers for a new setup, storing a new upload sequence in the EEPROM scratchpad (Step 1 through Step 4), and executing an EEPROM upload (Register 0x0E02, Bit 0) until all of the desired setups have been uploaded to the EEPROM.

Note that, on the final upload sequence stored in the scratchpad, the pause instruction (0xFE) must be replaced with an end instruction (0xFF).

To download a specific setup on demand, first store the condition associated with the desired setup in Register 0x0E01, Bits[3:0]. Then perform an EEPROM download (Register 0x0E03, Bit 1). Alternatively, to download a specific setup at power-up, apply the required logic levels necessary to encode the desired condition on the M1 to M0 multifunction pins.

(Note that only Condition 1 through Condition 3 are accessible via the M pins.) Then power up the device; an automatic EEPROM download occurs. The condition (as established by the M1 and M0 multifunction pins) guides the download sequence and results in a specific setup.

Keep in mind that the number of setups that can be stored in the EEPROM is limited. The EEPROM can hold a total of 2048 bytes. Each nondata instruction requires one byte of storage. Each data instruction, however, requires $N + 4$ bytes of storage, where N is the number of transferred register bytes and the other four bytes include the data instruction itself (one byte), the target address (two bytes), and the checksum calculated by the EEPROM controller during the upload sequence (one byte).

SERIAL CONTROL PORT

The AD9559 serial control port is a flexible, synchronous serial communications port that provides a convenient interface to many industry-standard microcontrollers and microprocessors. The AD9559 serial control port is compatible with most synchronous transfer formats, including I²C, Motorola SPI, and Intel SSR protocols. The serial control port allows read/write access to the AD9559 register map.

In SPI mode, single or multiple byte transfers are supported. The SPI port configuration is programmable via Register 0x0000. This register is integrated into the SPI control logic rather than in the register map and is distinct from the I²C Register 0x0000. It is also inaccessible to the EEPROM controller.

Although the AD9559 supports both the SPI and I²C serial port protocols, only one is active following power-up (as determined by the M3, M4/SDO, and M5/ $\overline{\text{CS}}$ multifunction pins during the start-up sequence). That is, the only way to change the serial port protocol is to reset the device (or cycle the device power supply).

SPI/I²C PORT SELECTION

Because the AD9559 supports both SPI and I²C protocols, the active serial port protocol depends on the logic state of M3, M4/SDO, and the M5/ $\overline{\text{CS}}$ pins. See Table 25 for the I²C address assignments. Note that there are no internal pull-up or pull-down resistors on these pins.

Table 25. SPI/I²C Serial Port Setup

| M5/ $\overline{\text{CS}}$ | M4/SDO | M3 | SPI/I ² C Address |
|----------------------------|----------------|------|----------------------------------|
| X ¹ | X ¹ | Low | SPI |
| Low | Low | High | I ² C, 1101100 (0x6C) |
| Low | High | High | I ² C, 1101101 (0x6D) |
| High | Low | High | I ² C, 1101110 (0x6E) |
| High | High | High | I ² C, 1101111 (0x6F) |

¹X = Don't care.

SPI SERIAL PORT OPERATION

Pin Descriptions

The SCLK (serial clock) pin serves as the serial shift clock. This pin is an input. SCLK synchronizes serial control port read and write operations. The rising edge SCLK registers write data bits, and the falling edge registers read data bits. The SCLK pin supports a maximum clock rate of 40 MHz.

The SDIO (serial data input/output) pin is a dual-purpose pin and acts either as an input only (unidirectional mode) or as both an input and an output (bidirectional mode). The AD9559 default SPI mode is bidirectional.

The SDO (serial data output) pin is useful only in unidirectional I/O mode. It serves as the data output pin for read operations.

The $\overline{\text{CS}}$ (chip select) pin is an active low control that gates read and write operations. This pin is internally connected to a 30 k Ω pull-up resistor. When $\overline{\text{CS}}$ is high, the SDO and SDIO pins go into a high impedance state.

SPI Mode Operation

The SPI port supports both 3-wire (bidirectional) and 4-wire (unidirectional) hardware configurations and both MSB-first and LSB-first data formats. Both the hardware configuration and data format features are programmable. By default, the AD9559 uses the bidirectional MSB-first mode. The reason that bidirectional is the default mode is so that the user can still write to the device, if it is wired for unidirectional operation, to switch to unidirectional mode.

Assertion (active low) of the $\overline{\text{CS}}$ pin initiates a write or read operation to the AD9559 SPI port. For data transfers of three bytes or fewer (excluding the instruction word), the device supports the $\overline{\text{CS}}$ stalled high mode. In this mode, the $\overline{\text{CS}}$ pin can be temporarily deasserted on any byte boundary, allowing time for the system controller to process the next byte. $\overline{\text{CS}}$ can be deasserted only on byte boundaries, however. This applies to both the instruction and data portions of the transfer.

During stall high periods, the serial control port state machine enters a wait state until all data is sent. If the system controller decides to abort a transfer midstream, the state machine must be reset by either completing the transfer or by asserting the $\overline{\text{CS}}$ pin for at least one complete SCLK cycle (but less than eight SCLK cycles). Deasserting the $\overline{\text{CS}}$ pin on a nonbyte boundary terminates the serial transfer and flushes the buffer.

In the streaming mode (see Table 26), any number of data bytes can be transferred in a continuous stream. The register address is automatically incremented or decremented. $\overline{\text{CS}}$ must be deasserted at the end of the last byte transferred, thereby ending the stream mode.

Table 26. Byte Transfer Count

| W1 | W0 | Bytes to Transfer |
|----|----|-------------------|
| 0 | 0 | 1 |
| 0 | 1 | 2 |
| 1 | 0 | 3 |
| 1 | 1 | Streaming mode |

Communication Cycle—Instruction Plus Data

The AD9559 supports the long instruction mode only. The SPI protocol consists of a two-part communication cycle. The first part is a 16-bit instruction word that is coincident with the first 16 SCLK rising edges and a payload. The instruction word provides the AD9559 serial control port with information regarding the payload. The instruction word includes the $\overline{R/W}$ bit that indicates the direction of the payload transfer (that is, a read or write operation). The instruction word also indicates the number of bytes in the payload and the starting register address of the first payload byte.

Write

If the instruction word indicates a write operation, the payload is written into the serial control port buffer of the AD9559. Data bits are registered on the rising edge of SCLK. The length of the transfer (1, 2, or 3 bytes or streaming mode) depends on the W0 and W1 bits (see Table 26) in the instruction byte. When not streaming, \overline{CS} can be deasserted after each sequence of eight bits to stall the bus (except after the last byte, where it ends the cycle). When the bus is stalled, the serial transfer resumes when \overline{CS} is asserted. Deasserting the \overline{CS} pin on a nonbyte boundary resets the serial control port. Reserved or blank registers are not skipped over automatically during a write sequence. Therefore, the user must know what bit pattern to write to the reserved registers to preserve proper operation of the part. Generally, it does not matter what data is written to blank registers, but it is customary to use 0s.

Most of the serial port registers are buffered (see the Buffered/Active Registers section for details on the difference between buffered and active registers). Therefore, data written into buffered registers does not take effect immediately. An additional operation is needed to transfer buffered serial control port contents to the registers that actually control the device. This is accomplished with an IO_UPDATE operation, which is performed in one of two ways. One method is to write a Logic 1 to Register 0x0005, Bit 0 (this bit is an autoclearing bit). The other method is to use an external signal via an appropriately programmed multifunction pin. The user can change as many register bits as desired before executing an IO_UPDATE. The IO_UPDATE operation transfers the buffer register contents to their active register counterparts.

Read

If the instruction word indicates a read operation, the next $N \times 8$ SCLK cycles clock out the data from the address specified in the instruction word. N is the number of data bytes read and depends on the W0 and W1 bits of the instruction word. The readback data is valid on the falling edge of SCLK. Blank registers are not skipped over during readback.

A readback operation takes data from either the serial control port buffer registers or the active registers, as determined by Register 0x0004, Bit 0.

SPI Instruction Word (16 Bits)

The MSB of the 16-bit instruction word is $\overline{R/W}$, which indicates whether the instruction is a read or a write. The next two bits, W1 and W0, indicate the number of bytes in the transfer (see Table 26). The final 13 bits are the register address (A12 to A0), which indicates the starting register address of the read/write operation (see Table 28).

SPI MSB-/LSB-First Transfers

The AD9559 instruction word and payload can be MSB first or LSB first. The default for the AD9559 is MSB first. The LSB-first mode can be set by writing a 1 to Register 0x0000, Bit 6. Immediately after the LSB-first bit is set, subsequent serial control port operations are LSB first.

When MSB-first mode is active, the instruction and data bytes must be written from MSB to LSB. Multibyte data transfers in MSB-first format start with an instruction byte that includes the register address of the most significant payload byte. Subsequent data bytes must follow in order from high address to low address. In MSB-first mode, the serial control port internal address generator decrements for each data byte of the multibyte transfer cycle.

When Register 0x0000, Bit 6 = 1 (LSB first), the instruction and data bytes must be written from LSB to MSB. Multibyte data transfers in LSB-first format start with an instruction byte that includes the register address of the least significant payload byte followed by multiple data bytes. The serial control port internal byte address generator increments for each byte of the multibyte transfer cycle.

For multibyte MSB-first (default) I/O operations, the serial control port register address decrements from the specified starting address toward Address 0x0000. For multibyte LSB-first I/O operations, the serial control port register address increments from the starting address toward Address 0x1FFF. Reserved addresses are not skipped during multibyte I/O operations; therefore, the user should write the default value to a reserved register and 0s to unmapped registers. Note that it is more efficient to issue a new write command than to write the default value to more than two consecutive reserved (or unmapped) registers.

Table 27. Streaming Mode (No Addresses Are Skipped)

| Write Mode | Address Direction | Stop Sequence |
|------------|-------------------|-----------------|
| LSB First | Increment | 0x0000...0x1FFF |
| MSB First | Decrement | 0x1FFF...0x0000 |

Table 28. Serial Control Port, 16-Bit Instruction Word, MSB First
MSB

| I15 | I14 | I13 | I12 | I11 | I10 | I9 | I8 | I7 | I6 | I5 | I4 | I3 | I2 | I1 | I0 |
|-----|-----|-----|-----|-----|-----|----|----|----|----|----|----|----|----|----|----|
| R/W | W1 | W0 | A12 | A11 | A10 | A9 | A8 | A7 | A6 | A5 | A4 | A3 | A2 | A1 | A0 |

LSB

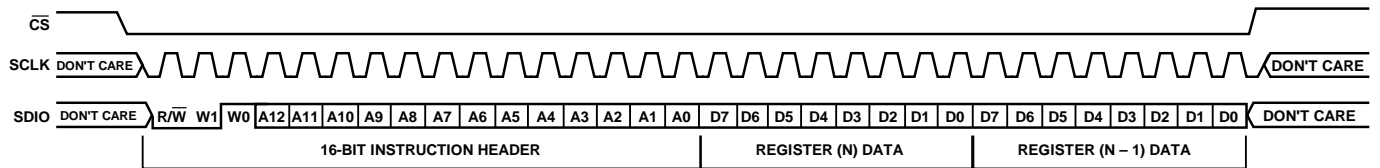

Figure 45. Serial Control Port Write—MSB First, 16-Bit Instruction, Two Bytes of Data

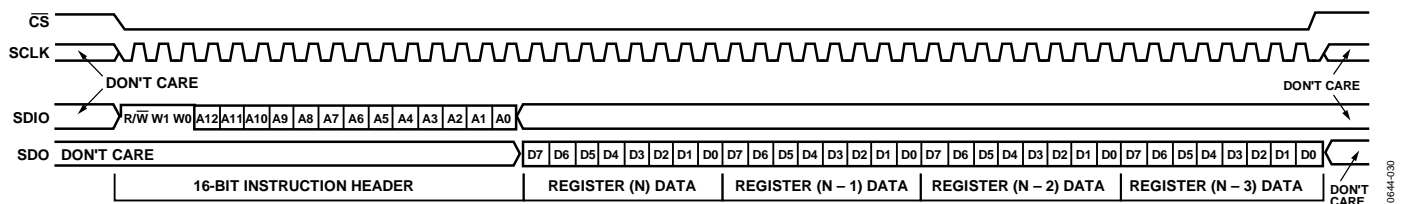

Figure 46. Serial Control Port Read—MSB First, 16-Bit Instruction, Four Bytes of Data

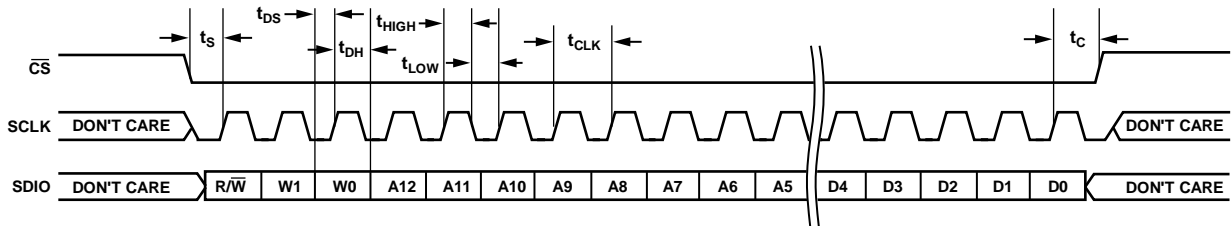

Figure 47. Serial Control Port Write—MSB First, 16-Bit Instruction, Timing Measurements

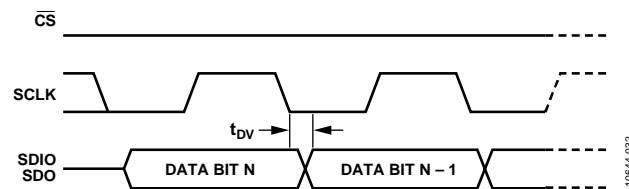

Figure 48. Timing Diagram for Serial Control Port Register Read

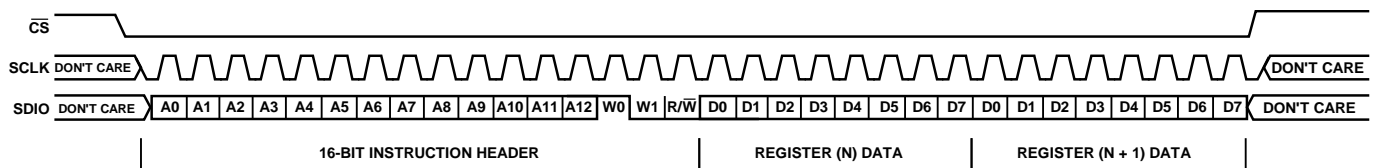

Figure 49. Serial Control Port Write—LSB First, 16-Bit Instruction, Two Bytes of Data

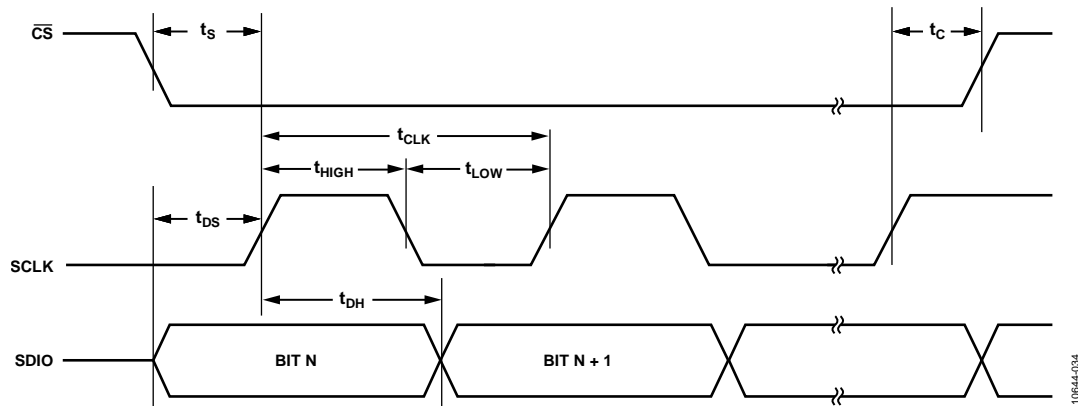

Figure 50. Serial Control Port Timing—Write

Table 29. Serial Control Port Timing

| Parameter | Description |
|------------|---|
| t_{DS} | Setup time between data and the rising edge of SCLK |
| t_{DH} | Hold time between data and the rising edge of SCLK |
| t_{CLK} | Period of the clock |
| t_s | Setup time between the \overline{CS} falling edge and the SCLK rising edge (start of the communication cycle) |
| t_c | Setup time between the SCLK rising edge and \overline{CS} rising edge (end of the communication cycle) |
| t_{HIGH} | Minimum period that SCLK should be in a logic high state |
| t_{LOW} | Minimum period that SCLK should be in a logic low state |
| t_{DV} | SCLK to valid SDIO and SDO (see Figure 48) |

I²C SERIAL PORT OPERATION

The I²C interface has the advantage of requiring only two control pins and is a de facto standard throughout the I²C industry. However, its disadvantage is programming speed, which is 400 kbps maximum. The AD9559 I²C port design is based on the I²C fast mode standard; it supports both the 100 kHz standard mode and 400 kHz fast mode. Fast mode imposes a glitch tolerance requirement on the control signals. That is, the input receivers ignore pulses of less than 50 ns duration.

The AD9559 I²C port consists of a serial data line (SDA) and a serial clock line (SCL). In an I²C bus system, the AD9559 is connected to the serial bus (data bus SDA and clock bus SCL) as a slave device; that is, no clock is generated by the AD9559. The AD9559 uses direct 16-bit memory addressing instead of traditional 8-bit memory addressing.

The AD9559 allows up to seven unique slave devices to occupy the I²C bus. These are accessed via a 7-bit slave address transmitted as part of an I²C packet. Only the device with a matching slave address responds to subsequent I²C commands. Table 25 lists the supported device slave addresses.

I²C Bus Characteristics

A summary of the various I²C abbreviations appears in Table 30.

Table 30. I²C Bus Abbreviation Definitions

| Abbreviation | Definition |
|--------------|----------------|
| S | Start |
| Sr | Repeated start |
| P | Stop |
| A | Acknowledge |
| \bar{A} | Nonacknowledge |
| \bar{W} | Write |
| R | Read |

The transfer of data is shown in Figure 51. One clock pulse is generated for each data bit transferred. The data on the SDA line must be stable during the high period of the clock. The high or low state of the data line can change only when the clock signal on the SCL line is low.

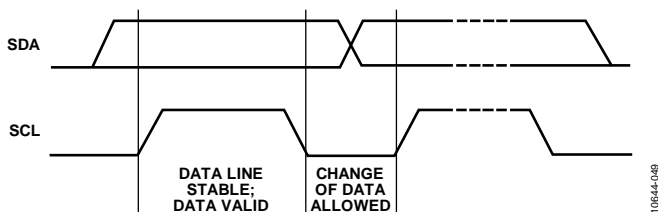

Figure 51. Valid Bit Transfer

Start/stop functionality is shown in Figure 52. The start condition is characterized by a high-to-low transition on the SDA line while SCL is high. The start condition is always generated by the master to initialize a data transfer. The stop condition is characterized by a low-to-high transition on the SDA line while SCL is high. The stop condition is always generated by the master to terminate a data transfer. Every byte on the SDA line must be eight bits long. Each byte must be followed by an acknowledge bit; bytes are sent MSB first.

The acknowledge bit (A) is the ninth bit attached to any 8-bit data byte. An acknowledge bit is always generated by the receiving device (receiver) to inform the transmitter that the byte has been received. It is done by pulling the SDA line low during the ninth clock pulse after each 8-bit data byte.

The nonacknowledge bit (\bar{A}) is the ninth bit attached to any 8-bit data byte. A nonacknowledge bit is always generated by the receiving device (receiver) to inform the transmitter that the byte has not been received. It is done by leaving the SDA line high during the ninth clock pulse after each 8-bit data byte.

Data Transfer Process

The master initiates data transfer by asserting a start condition. This indicates that a data stream follows. All I²C slave devices connected to the serial bus respond to the start condition.

The master then sends an 8-bit address byte over the SDA line, consisting of a 7-bit slave address (MSB first) plus an R/W bit. This bit determines the direction of the data transfer, that is, whether data is written to or read from the slave device (0 = write, 1 = read).

The peripheral whose address corresponds to the transmitted address responds by sending an acknowledge bit. All other devices on the bus remain idle while the selected device waits for data to be read from or written to it. If the R/W bit is 0, the master (transmitter) writes to the slave device (receiver). If the R/W bit is 1, the master (receiver) reads from the slave device (transmitter).

The format for these commands is described in the Data Transfer Format section.

Data is then sent over the serial bus in the format of nine clock pulses, one data byte (eight bits) from either master (write mode) or slave (read mode) followed by an acknowledge bit from the receiving device. The number of bytes that can be transmitted per transfer is unrestricted. In write mode, the first two data bytes immediately after the slave address byte are the internal memory (control registers) address bytes, with the high address byte first. This addressing scheme gives a memory address of up to $2^{16} - 1 = 65,535$. The data bytes after these two memory address bytes are register data written to or read from the control registers. In read mode, the data bytes after the slave address byte are register data written to or read from the control registers.

When all the data bytes are read or written, stop conditions are established. In write mode, the master (transmitter) asserts a stop condition to end data transfer during the 10th clock pulse following the acknowledge bit for the last data byte from the slave device (receiver). In read mode, the master device (receiver) receives the last data byte from the slave device (transmitter) but does not pull SDA low during the ninth clock pulse. This is known as a nonacknowledge bit. By receiving the nonacknowledge bit,

the slave device knows that the data transfer is finished and enters idle mode. The master then takes the data line low during the low period before the 10th clock pulse, and high during the 10th clock pulse to assert a stop condition.

A start condition can be used in place of a stop condition. Furthermore, a start or stop condition can occur at any time, and partially transferred bytes are discarded.

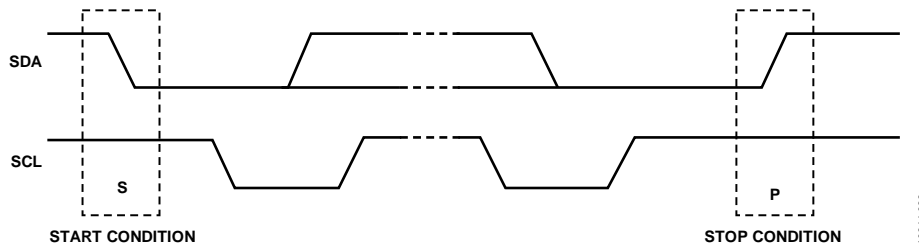

Figure 52. Start and Stop Conditions

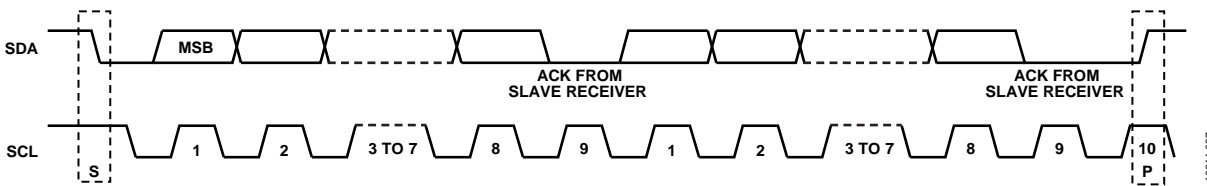

Figure 53. Acknowledge Bit

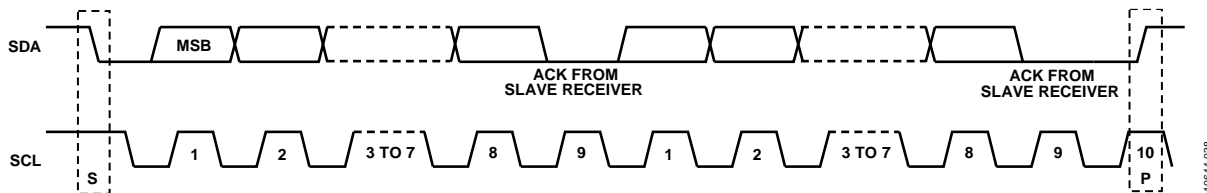

Figure 54. Data Transfer Process (Master Write Mode, 2-Byte Transfer)

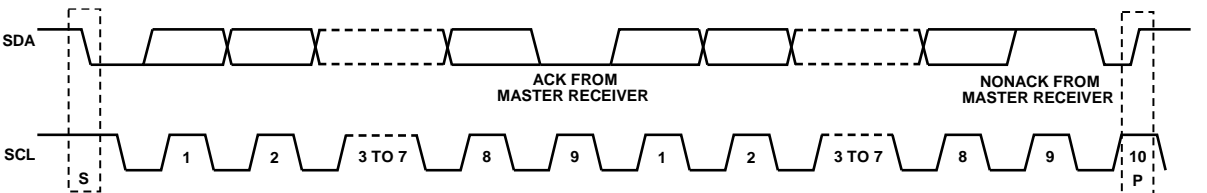

Figure 55. Data Transfer Process (Master Read Mode, 2-Byte Transfer)

Data Transfer Format

Write byte format—the write byte protocol is used to write a register address to the RAM starting from the specified RAM address.

| | | | | | | | | | | | | | | |
|---|---------------|----------------|---|-----------------------|---|----------------------|---|------------|---|------------|---|------------|---|---|
| S | Slave address | \overline{W} | A | RAM address high byte | A | RAM address low byte | A | RAM Data 0 | A | RAM Data 1 | A | RAM Data 2 | A | P |
|---|---------------|----------------|---|-----------------------|---|----------------------|---|------------|---|------------|---|------------|---|---|

Send byte format—the send byte protocol is used to set up the register address for subsequent reads.

| | | | | | | | | |
|---|---------------|----------------|---|-----------------------|---|----------------------|---|---|
| S | Slave address | \overline{W} | A | RAM address high byte | A | RAM address low byte | A | P |
|---|---------------|----------------|---|-----------------------|---|----------------------|---|---|

Receive byte format—the receive byte protocol is used to read the data byte(s) from RAM starting from the current address.

| | | | | | | | | | | |
|---|---------------|---|---|------------|---|------------|---|------------|----------------|---|
| S | Slave address | R | A | RAM Data 0 | A | RAM Data 1 | A | RAM Data 2 | \overline{A} | P |
|---|---------------|---|---|------------|---|------------|---|------------|----------------|---|

Read byte format—the combined format of the send byte and the receive byte.

| | | | | | | | | | | | | | | | | | | |
|---|---------------|----------------|---|-----------------------|---|----------------------|---|----|---------------|---|---|------------|---|------------|---|------------|----------------|---|
| S | Slave address | \overline{W} | A | RAM address high byte | A | RAM address low byte | A | Sr | Slave address | R | A | RAM Data 0 | A | RAM Data 1 | A | RAM Data 2 | \overline{A} | P |
|---|---------------|----------------|---|-----------------------|---|----------------------|---|----|---------------|---|---|------------|---|------------|---|------------|----------------|---|

I²C Serial Port Timing

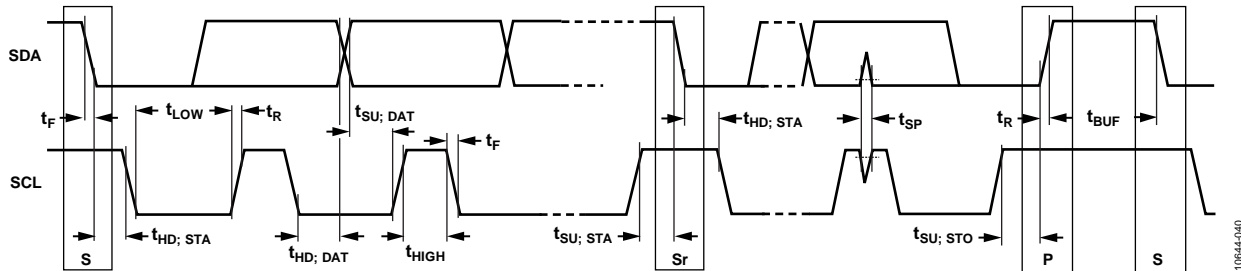

Figure 56. I²C Serial Port Timing

Table 31. I²C Timing Definitions

| Parameter | Description |
|----------------------|---|
| f _{SCL} | Serial clock |
| t _{BUF} | Bus free time between stop and start conditions |
| t _{HD; STA} | Repeated hold time start condition |
| t _{SU; STA} | Repeated start condition setup time |
| t _{SU; STO} | Stop condition setup time |
| t _{HD; DAT} | Data hold time |
| t _{SU; DAT} | Date setup time |
| t _{LOW} | SCL clock low period |
| t _{HIGH} | SCL clock high period |
| t _R | Minimum/maximum receive SCL and SDA rise time |
| t _F | Minimum/maximum receive SCL and SDA fall time |
| t _{SP} | Pulse width of voltage spikes that must be suppressed by the input filter |

PROGRAMMING THE I/O REGISTERS

The register map (see Table 34) spans an address range from 0x0000 through 0x0E4F. Each address provides access to one byte (eight bits) of data. Each individual register is identified by its four-digit hexadecimal address (for example, Register 0x0A23). In some cases, a group of addresses collectively defines a register.

In general, when a group of registers defines a control parameter, the LSB of the value resides in the D0 position of the register with the lowest address. The bit weight increases right to left, from the lowest register address to the highest register address. Note that the EEPROM storage sequence registers (Address 0x0E10 to Address 0x0E4F) are an exception to this convention (see the EEPROM Instructions section).

BUFFERED/ACTIVE REGISTERS

There are two copies of most registers: buffered and active. The value in the active registers is the one that is in use. The buffered registers are the ones that take effect the next time the user writes 0x01 to Register 0x0005 (IO_UPDATE). Buffering the registers allows the user to update a group of registers (like the APLL settings) simultaneously, avoiding the potential of unpredictable behavior in the part. Registers with an L in the option column of the register map (see Table 34) are live, meaning that they take effect the moment the serial port transfers that data byte.

WRITE DETECT REGISTERS

A W in the option column of the register map (see Table 34) identifies a register with write detection. These registers contain additional logic to avoid glitches or unwanted operation. Write detection can be disabled by setting Register 0x0004, Bit 3 to 1b.

Table 32. Register Write Detection Description

| Option | Register Operation |
|--------|--|
| W0 | The input reference is immediately faulted when these registers are written to, and the input reference validation timer restarts when the next IO_UPDATE occurs (Register 0x0005 = 0x01). |
| W1 | The lock detector declares unlock immediately when these registers are written to, and the lock detection restarts when the next IO_UPDATE occurs. |
| W2 | After these registers are written to, the DPLL automatically enters holdover for one PFD cycle (and then exits) when an IO_UPDATE is issued. |
| W5 | The watchdog timer resets automatically when these registers are changed, and then resumes counting on the next IO_UPDATE. |
| W6 | The system clock stability timer is automatically reset when these registers are changed, and then resumes counting on the next IO_UPDATE. |
| W7 | If these registers are written to while they are assigned to an existing function, the existing function stops immediately. The new function starts when the next IO_UPDATE occurs. |

AUTOCLEAR REGISTERS

An A in the option column of the register map (see Table 34) identifies an autoclearing register. Typically, the active value for an auto-clearing register takes effect following an IO_UPDATE. The bit is cleared by the internal device logic upon completion of the prescribed action.

REGISTER ACCESS RESTRICTIONS

Read and write access to the register map may be restricted, depending on the register in question, the source and direction of access, and the current state of the device. Each register can be classified into one or more access types. When more than one type applies, the most restrictive condition is the one that applies.

When access is denied to a register, all attempts to read the register return a 0 byte, and all attempts to write to the register are ignored. Access to nonexistent registers is handled in the same way as for a denied register.

Regular Access

Registers with regular access do not fall into any other category. Both read and write access to registers of this type can be from either the serial ports or EEPROM controller. However, only one of these sources can have access to a register at any given time (access is mutually exclusive). When the EEPROM controller is active, either in load or store mode, it has exclusive access to these registers.

Read-Only Access

An R in the option column of the register map (see Table 34) identifies read-only registers. Access is available at all times, including when the EEPROM controller is active. Note that read-only registers (R) are inaccessible to the EEPROM as well.

Exclusion from EEPROM Access

An E in the option column of the register map (see Table 34) identifies a register with contents that are inaccessible to the EEPROM. That is, the contents of this type of register cannot be transferred directly to the EEPROM or vice versa. Note that read-only registers (R) are inaccessible to the EEPROM as well.

THERMAL PERFORMANCE

Table 33. Thermal Parameters for the 72-Lead LFCSP Package

| Symbol | Thermal Characteristic Using a JEDEC 51-7 Plus JEDEC 51-5 2S2P Test Board ¹ | Value ² | Unit |
|----------------|--|--------------------|------|
| θ_{JA} | Junction-to-ambient thermal resistance, 0.0 m/sec airflow per JEDEC JESD51-2 (still air) | 20.0 | °C/W |
| θ_{JMA} | Junction-to-ambient thermal resistance, 1.0 m/sec airflow per JEDEC JESD51-6 (moving air) | 18.0 | °C/W |
| θ_{JMA} | Junction-to-ambient thermal resistance, 2.5 m/sec airflow per JEDEC JESD51-6 (moving air) | 16.0 | °C/W |
| θ_{JB} | Junction-to-board thermal resistance, 0.0 m/sec airflow per JEDEC JESD51-8 (still air) | 10.7 | °C/W |
| θ_{JC} | Junction-to-case thermal resistance (die-to-heat sink) per MIL-Std 883, Method 1012.1 | 1.1 | °C/W |
| Ψ_{JT} | Junction-to-top-of-package characterization parameter, 0 m/sec airflow per JEDEC JESD51-2 (still air) | 0.1 | °C/W |
| Ψ_{JT} | Junction-to-top-of-package characterization parameter, 1.0 m/sec airflow per JEDEC JESD51-6 (moving air) | 0.1 | °C/W |
| Ψ_{JT} | Junction-to-top-of-package characterization parameter, 2.5 m/sec airflow per JEDEC JESD51-6 (moving air) | 0.2 | °C/W |

¹ The exposed pad on the bottom of the package must be soldered to analog ground to achieve the specified thermal performance.

² Results are from simulations. The PCB is a JEDEC multilayer type. Thermal performance for actual applications requires careful inspection of the conditions in the application to determine if they are similar to those assumed in these calculations.

The AD9559 is specified for a case temperature (T_{CASE}). To ensure that T_{CASE} is not exceeded, an airflow source can be used. Use the following equation to determine the junction temperature on the application PCB:

$$T_J = T_{CASE} + (\Psi_{JT} \times PD)$$

where:

T_J is the junction temperature (°C).

T_{CASE} is the case temperature (°C) measured by the customer at the top center of the package.

Ψ_{JT} is the value as indicated in Table 33.

PD is the power dissipation (see the Table 3).

Values of θ_{JA} are provided for package comparison and PCB design considerations. θ_{JA} can be used for a first-order approximation of T_J by the equation

$$T_J = T_A + (\theta_{JA} \times PD)$$

where T_A is the ambient temperature (°C).

Values of θ_{JC} are provided for package comparison and PCB design considerations when an external heat sink is required.

Values of θ_{JB} are provided for package comparison and PCB design considerations.

POWER SUPPLY PARTITIONS

The [AD9559](#) power supplies are in two groups: VDD3 and VDD. All power and ground pins should be connected, even if certain blocks of the chip are powered down.

Ferrite beads with low ($< 0.7 \Omega$) dc resistance and approximately 600Ω impedance at 100 MHz are suitable for this application.

3.3 V SUPPLIES

All of the 3.3 V supplies can be supplied from one 3.3V power supply. Pin 28 is a serial port power supply and does not require a ferrite bead from the 3.3 V source.

Pin 1, Pin 12, Pin 18, and Pin 72 belong to PLL_0. It is advisable, but not mandatory, to have a place for a ferrite bead to isolate them from the 3.3 V source. The need for a ferrite bead depends on how quiet the 3.3 V source is. This group of pins never consumes more than 90 mA.

Pin 37, Pin 43, Pin 54, and Pin 55 belong to PLL_1, and the same recommendation given for the PLL_0 3.3 V pins applies here as well.

1.8 V SUPPLIES

All of the 1.8 V supplies can be connected to one common 1.8 V source.

Six ferrite beads should be used in the following locations:

- Between the 1.8 V source and Pin 13
- Between the 1.8 V source and Pin 14
- Between the 1.8 V source and Pin 17
- Between the 1.8 V source and Pin 38
- Between the 1.8 V source and Pin 41
- Between the 1.8 V source and Pin 42

The remaining VDD pins can be connected directly to the 1.8 V source.

BYPASS CAPACITORS FOR PIN 21 AND PIN 33

The performance of the [AD9559](#) is enhanced by the use of a Size 0201, 0.1 μF capacitor between Pin 21 and Pin 22, as well as between Pin 33 and Pin 34, placed as close to the [AD9559](#) as possible and without the use of vias.

REGISTER MAP

Register addresses that are not listed in Table 34 are not used, and writing to those registers has no effect. The user should write the default value to sections of registers marked reserved. R = read only. A = autoclear. E = excluded from EEPROM loading. W1, W2, W5, W6, and W7 = write detection (see Table 32 for more information). L = live (IO_UPDATE not required for register to take effect or for a read-only register to be updated.)

Table 34.

| Reg Addr (Hex) | Opt | Name | D7 | D6 | D5 | D4 | D3 | D2 | D1 | D0 | Def (Hex) | |
|--|------|--------------------------|----------------------------------|-----------------------------|---------------------------|-------------------------|---------------------------|------------------|---------------------------|----------------------|-----------|------|
| Serial Control Port and Part Identification | | | | | | | | | | | | |
| 0x0000 | L, E | SPI control | SDO enable | LSB first/increment address | Soft reset | Reserved | | | | | 0x00 | |
| 0x0000 | L | I ² C control | Reserved | | Soft reset | Reserved | | | | | 0x00 | |
| 0x0004 | | Readback control | Reserved | | | Reset sans reg map | Disable auto actions | Reserved | 2-wire SPI | Read buffer register | 0x00 | |
| 0x0005 | A, L | IO_UPDATE | Reserved | | | | | | | | IO_UPDATE | 0x00 |
| 0x000A | R, L | | Reserved | | | | | | | | 0x12 | |
| 0x000B | R, L | | Reserved | | | | | | | | 0x0F | |
| 0x000C | R, L | Part family ID | Clock part family ID, Bits[7:0] | | | | | | | | 0x02 | |
| 0x000D | R, L | | Clock part family ID, Bits[15:8] | | | | | | | | 0x00 | |
| 0x000E | L | User scratchpad | User scratchpad, Bits[7:0] | | | | | | | | 0x00 | |
| 0x000F | L | | User scratchpad, Bits[15:8] | | | | | | | | 0x00 | |
| General Configuration | | | | | | | | | | | | |
| 0x0100 | | M pin drivers | M3 driver mode, Bits[1:0] | | M2 driver mode, Bits[1:0] | | M1 driver mode, Bits[1:0] | | M0 driver mode, Bits[1:0] | | 0x00 | |
| 0x0101 | | | Reserved | | | | M5 driver mode, Bits[1:0] | | M4 driver mode, Bits[1:0] | | 0x00 | |
| 0x0102 | W7 | M0FUNC | M0 output/ input | M0 function, Bits[6:0] | | | | | | | | 0x00 |
| 0x0103 | W7 | M1FUNC | M1 output/ input | M1 function, Bits[6:0] | | | | | | | | 0x00 |
| 0x0104 | W7 | M2FUNC | M2 output/ input | M2 function, Bits[6:0] | | | | | | | | 0x00 |
| 0x0105 | W7 | M3FUNC | M3 output/ input | M3 function, Bits[6:0] | | | | | | | | 0x00 |
| 0x0106 | W7 | M4FUNC | M4 output/ input | M4 function, Bits[6:0] | | | | | | | | 0x00 |
| 0x0107 | W7 | M5FUNC | M5 output/ input | M5 function, Bits[6:0] | | | | | | | | 0x00 |
| 0x0108 | W5 | Watchdog timer | Watchdog timer (ms), Bits[7:0] | | | | | | | | 0x00 | |
| 0x0109 | W5 | | Watchdog timer (ms), Bits[15:8] | | | | | | | | 0x00 | |
| 0x010A | | IRQ mask common | Reserved | SYSCLK unlocked | SYSCLK stable | SYSCLK locked | Watchdog timer | Reserved | EEPROM fault | EEPROM complete | 0x00 | |
| 0x010B | | | Reserved | REFB validated | REFB fault cleared | REFB fault | Reserved | REFA validated | REFA fault cleared | REFA fault | 0x00 | |
| 0x010C | | | Reserved | REFD validated | REFD fault cleared | REFD fault | Reserved | REFC validated | REFC fault cleared | REFC fault | 0x00 | |
| 0x010D | | IRQ mask DPLL_0 | Frequency unclamped | Frequency clamped | Phase slew unlimited | Phase slew limited | Frequency unlocked | Frequency locked | Phase unlocked | Phase locked | 0x00 | |
| 0x010E | | | Switching | Free run | Holdover | History updated | REFD activated | REFC activated | REFB activated | REFA activated | 0x00 | |
| 0x010F | | | Reserved | | | Sync clock distribution | APLL_0 unlocked | APLL_0 locked | APLL_0 cal complete | APLL_0 cal started | 0x00 | |
| 0x0110 | | IRQ mask DPLL_1 | Frequency unclamped | Frequency clamped | Phase slew unlimited | Phase slew limited | Frequency unlocked | Frequency locked | Phase unlocked | Phase locked | 0x00 | |
| 0x0111 | | | Switching | Free run | Holdover | History updated | REFD activated | REFC activated | REFB activated | REFA activated | 0x00 | |
| 0x0112 | | | Reserved | | | Sync clock distribution | APLL_1 unlocked | APLL_1 locked | APLL_1 cal complete | APLL_1 cal started | 0x00 | |

| Reg Addr (Hex) | Opt | Name | D7 | D6 | D5 | D4 | D3 | D2 | D1 | D0 | Def (Hex) | |
|--------------------------|-----|--|---|----|----|---|------------------------------|------------------------------|----------------------------|------------------------------------|-----------|------|
| System Clock | | | | | | | | | | | | |
| 0x0200 | | SYSCLK PLL feedback divider and config | System clock K divider, Bits[7:0] | | | | | | | 0x08 | | |
| 0x0201 | | | Reserved | | | | SYSCLK XTAL enable | SYSCLK J1 divider, Bits[1:0] | | SYSCLK doubler enable (J0 divider) | 0x09 | |
| 0x0202 | | SYSCLK period | Nominal system clock period (fs), Bits[7:0] (1 ns at 1 ppm accuracy) | | | | | | | | | 0x0E |
| 0x0203 | | | Nominal system clock period (fs), Bits[15:8] (1 ns at 1 ppm accuracy) | | | | | | | | | 0x67 |
| 0x0204 | | | Reserved | | | Nominal system clock period, Bits[20:16] | | | | | | 0x13 |
| 0x0205 | W6 | SYSCLK stability | System clock stability period (ms), Bits[7:0] | | | | | | | | | 0x32 |
| 0x0206 | W6 | | System clock stability period (ms), Bits[15:8] | | | | | | | | | 0x00 |
| 0x0207 | W6 | | Reserved | | | System clock stability period (ms), Bits[19:16] | | | | | | 0x00 |
| Reference Input A | | | | | | | | | | | | |
| 0x0300 | | REFA logic type | Reserved | | | | Enable REFA divide-by-2 | Reserved | REFA logic type, Bits[1:0] | | | 0x00 |
| 0x0301 | | REFA R divider (20 bits) | R divider, Bits[7:0] | | | | | | | | | 0xCF |
| 0x0302 | | | R divider, Bits[15:8] | | | | | | | | | 0x00 |
| 0x0303 | | | Reserved | | | | R divider, Bits[19:16] | | | | | 0x00 |
| 0x0304 | W0 | REFA period (up to 1.1 ms) | Nominal period (fs), Bits[7:0] (default: 51.44 ns = 1/(19.44 MHz) for default system clock setting) | | | | | | | | | 0xC9 |
| 0x0305 | W0 | | Nominal period (fs), Bits[15:8] | | | | | | | | | 0xEA |
| 0x0306 | W0 | | Nominal period (fs), Bits[23:16] | | | | | | | | | 0x10 |
| 0x0307 | W0 | | Nominal period (fs), Bits[31:24] | | | | | | | | | 0x03 |
| 0x0308 | W0 | | Nominal period (fs), Bits[39:32] | | | | | | | | | 0x00 |
| 0x0309 | W0 | REFA frequency tolerance | Inner tolerance (1 ÷ ppm), Bits[7:0] (for unlock to lock condition; max: 10%, min: 2 ppm) (default: 5%) | | | | | | | | | 0x14 |
| 0x030A | W0 | | Inner tolerance (1 ÷ ppm), Bits[15:8] (for unlock to lock condition; max: 10%, min: 2 ppm) | | | | | | | | | 0x00 |
| 0x030B | W0 | | Reserved | | | | Inner tolerance, Bits[19:16] | | | | | 0x00 |
| 0x030C | W0 | | Outer tolerance (1 ÷ ppm), Bits[7:0] (for lock to unlock; max: 10%, min: 2 ppm) (default: 10%) | | | | | | | | | 0x0A |
| 0x030D | W0 | | Outer tolerance (1 ÷ ppm), Bits[15:8] (for lock to unlock; max: 10%, min: 2 ppm) | | | | | | | | | 0x00 |
| 0x030E | W0 | | Reserved | | | | Outer tolerance, Bits[19:16] | | | | | 0x00 |
| 0x030F | W0 | REFA validation | Validation timer (ms), Bits[7:0] (up to 65.5 sec) | | | | | | | | | 0x0A |
| 0x0310 | W0 | | Validation timer (ms), Bits[15:8] (up to 65.5 sec) | | | | | | | | | 0x00 |
| 0x0311 | W1 | REFA phase lock detector | Phase lock threshold (ps), Bits[7:0] | | | | | | | | | 0xBC |
| 0x0312 | W1 | | Phase lock threshold (ps), Bits[15:8] | | | | | | | | | 0x02 |
| 0x0313 | W1 | | Phase lock threshold (ps), Bits [23:16] | | | | | | | | | 0x00 |
| 0x0314 | W1 | | Phase lock fill rate, Bits[7:0] | | | | | | | | | 0x0A |
| 0x0315 | W1 | | Phase lock drain rate, Bits[7:0] | | | | | | | | | 0x0A |
| 0x0316 | W1 | REFA frequency lock detector | Frequency lock threshold, Bits[7:0] | | | | | | | | | 0xBC |
| 0x0317 | W1 | | Frequency lock threshold, Bits[15:8] | | | | | | | | | 0x02 |
| 0x0318 | W1 | | Frequency lock threshold, Bits[23:16] | | | | | | | | | 0x00 |
| 0x0319 | W1 | | Frequency lock fill rate, Bits[7:0] | | | | | | | | | 0x0A |
| 0x031A | W1 | | Frequency lock drain rate, Bits[7:0] | | | | | | | | | 0x0A |
| Reference Input B | | | | | | | | | | | | |
| 0x0320 | | REFB logic type | Reserved | | | | Enable REFB divide-by-2 | Reserved | REFB logic type, Bits[1:0] | | | 0x00 |
| 0x0321 | | REFB R divider (20 bits) | R divider, Bits[7:0] | | | | | | | | | 0xCF |
| 0x0322 | | | R divider, Bits[15:8] | | | | | | | | | 0x00 |
| 0x0323 | | | Reserved | | | | R divider, Bits[19:16] | | | | | 0x00 |
| 0x0324 | W0 | REFB reference period (up to 1.1 ms) | Nominal period (fs), Bits[7:0] (default: 51.44 ns = 1/(19.44 MHz) for default system clock setting) | | | | | | | | | 0xC9 |
| 0x0325 | W0 | | Nominal period (fs), Bits[15:8] | | | | | | | | | 0xEA |
| 0x0326 | W0 | | Nominal period (fs), Bits[23:16] | | | | | | | | | 0x10 |
| 0x0327 | W0 | | Nominal period (fs), Bits[31:24] | | | | | | | | | 0x03 |
| 0x0328 | W0 | | Nominal period (fs), Bits[39:32] | | | | | | | | | 0x00 |
| 0x0329 | W0 | REFB frequency tolerance | Inner tolerance (1 ÷ ppm), Bits[7:0] (for unlock to lock condition; max: 10%, min: 2 ppm) (default: 5%) | | | | | | | | | 0x14 |
| 0x032A | W0 | | Inner tolerance (1 ÷ ppm), Bits[15:8] (for unlock to lock condition; max: 10%, min: 2 ppm) | | | | | | | | | 0x00 |
| 0x032B | W0 | | Reserved | | | | Inner tolerance, Bits[19:16] | | | | | 0x00 |
| 0x032C | W0 | | Outer tolerance (1 ÷ ppm), Bits[7:0] (for lock to unlock; max: 10%, min: 2 ppm) (default: 10%) | | | | | | | | | 0x0A |
| 0x032D | W0 | | Outer tolerance (1 ÷ ppm), Bits[15:8] (for lock to unlock; max: 10%, min: 2 ppm) | | | | | | | | | 0x00 |
| 0x032E | W0 | | Reserved | | | | Outer tolerance, Bits[19:16] | | | | | 0x00 |

| Reg Addr (Hex) | Opt | Name | D7 | D6 | D5 | D4 | D3 | D2 | D1 | D0 | Def (Hex) |
|--------------------------|-----|------------------------------|---|----|----|----|------------------------------|----------|----------------------------|----|-----------|
| 0x032F | W0 | REFB validation | Validation timer (ms), Bits[7:0] (up to 65.5 sec) | | | | | | | | 0x0A |
| 0x0330 | W0 | | Validation timer (ms), Bits[15:8] (up to 65.5 sec) | | | | | | | | 0x00 |
| 0x0331 | W1 | REFB phase lock detector | Phase lock threshold (ps), Bits[7:0] | | | | | | | | 0xBC |
| 0x0332 | W1 | | Phase lock threshold (ps), Bits[15:8] | | | | | | | | 0x02 |
| 0x0333 | W1 | | Phase lock threshold (ps), Bits [23:16] | | | | | | | | 0x00 |
| 0x0334 | W1 | | Phase lock fill rate, Bits[7:0] | | | | | | | | 0x0A |
| 0x0335 | W1 | | Phase lock drain rate, Bits[7:0] | | | | | | | | 0x0A |
| 0x0336 | W1 | REFB frequency lock detector | Frequency lock threshold, Bits[7:0] | | | | | | | | 0xBC |
| 0x0337 | W1 | | Frequency lock threshold, Bits[15:8] | | | | | | | | 0x02 |
| 0x0338 | W1 | | Frequency lock threshold, Bits[23:16] | | | | | | | | 0x00 |
| 0x0339 | W1 | | Frequency lock fill rate, Bits[7:0] | | | | | | | | 0x0A |
| 0x033A | W1 | | Frequency lock drain rate, Bits[7:0] | | | | | | | | 0x0A |
| Reference Input C | | | | | | | | | | | |
| 0x0340 | | REFC logic type | Reserved | | | | Enable REFC divide-by-2 | Reserved | REFC logic type, Bits[1:0] | | 0x00 |
| 0x0341 | | REFC R divider (20 bits) | R divider, Bits[7:0] | | | | | | | | 0xCF |
| 0x0342 | | | R divider, Bits[15:8] | | | | | | | | 0x00 |
| 0x0343 | | | Reserved | | | | R divider, Bits[19:16] | | | | 0x00 |
| 0x0344 | W0 | REFC period (up to 1.1 ms) | Nominal period (fs), Bits[7:0] (default: 51.44 ns = 1/(19.44 MHz) for default system clock setting) | | | | | | | | 0xC9 |
| 0x0345 | W0 | | Nominal period (fs), Bits[15:8] | | | | | | | | 0xEA |
| 0x0346 | W0 | | Nominal period (fs), Bits[23:16] | | | | | | | | 0x10 |
| 0x0347 | W0 | | Nominal period (fs), Bits[31:24] | | | | | | | | 0x03 |
| 0x0348 | W0 | | Nominal period (fs), Bits[39:32] | | | | | | | | 0x00 |
| 0x0349 | W0 | REFC frequency tolerance | Inner tolerance (1 ÷ ppm), Bits[7:0] (for unlock to lock condition; max: 10%, min: 2 ppm) (default: 5%) | | | | | | | | 0x14 |
| 0x034A | W0 | | Inner tolerance (1 ÷ ppm), Bits[15:8] (for unlock to lock condition; max: 10%, min: 2 ppm) | | | | | | | | 0x00 |
| 0x034B | W0 | | Reserved | | | | Inner tolerance, Bits[19:16] | | | | 0x00 |
| 0x034C | W0 | | Outer tolerance (1 ÷ ppm), Bits[7:0] (for lock to unlock; max: 10%, min: 2 ppm) (default: 10%) | | | | | | | | 0x0A |
| 0x034D | W0 | | Outer tolerance (1 ÷ ppm), Bits[15:8] (for lock to unlock; max: 10%, min: 2 ppm) | | | | | | | | 0x00 |
| 0x034E | W0 | | Reserved | | | | Outer tolerance, Bits[19:16] | | | | 0x00 |
| 0x034F | W0 | REFC validation | Validation timer (ms), Bits[7:0] (up to 65.5 sec) | | | | | | | | 0x0A |
| 0x0350 | W0 | | Validation timer (ms), Bits[15:8] (up to 65.5 sec) | | | | | | | | 0x00 |
| 0x0351 | W1 | REFC phase lock detector | Phase lock threshold (ps), Bits[7:0] | | | | | | | | 0xBC |
| 0x0352 | W1 | | Phase lock threshold (ps), Bits[15:8] | | | | | | | | 0x02 |
| 0x0353 | W1 | | Phase lock threshold (ps), Bits [23:16] | | | | | | | | 0x00 |
| 0x0354 | W1 | | Phase lock fill rate, Bits[7:0] | | | | | | | | 0x0A |
| 0x0355 | W1 | | Phase lock drain rate, Bits[7:0] | | | | | | | | 0x0A |
| 0x0356 | W1 | REFC frequency lock detector | Frequency lock threshold, Bits[7:0] | | | | | | | | 0xBC |
| 0x0357 | W1 | | Frequency lock threshold, Bits[15:8] | | | | | | | | 0x02 |
| 0x0358 | W1 | | Frequency lock threshold, Bits[23:16] | | | | | | | | 0x00 |
| 0x0359 | W1 | | Frequency lock fill rate, Bits[7:0] | | | | | | | | 0x0A |
| 0x035A | W1 | | Frequency lock drain rate, Bits[7:0] | | | | | | | | 0x0A |
| Reference Input D | | | | | | | | | | | |
| 0x0360 | | REFD logic type | Reserved | | | | Enable REFD divide-by-2 | Reserved | REFD logic type, Bits[1:0] | | 0x00 |
| 0x0361 | | REFD R divider (20 bits) | R divider, Bits[7:0] | | | | | | | | 0xCF |
| 0x0362 | | | R divider, Bits[15:8] | | | | | | | | 0x00 |
| 0x0363 | | | Reserved | | | | R divider, Bits[19:16] | | | | 0x00 |
| 0x0364 | W0 | REFD period (up to 1.1 ms) | Nominal period (fs), Bits[7:0] (default: 51.44 ns = 1/(19.44 MHz) for default system clock setting) | | | | | | | | 0xC9 |
| 0x0365 | W0 | | Nominal period (fs), Bits[15:8] | | | | | | | | 0xEA |
| 0x0366 | W0 | | Nominal period (fs), Bits[23:16] | | | | | | | | 0x10 |
| 0x0367 | W0 | | Nominal period (fs), Bits[31:24] | | | | | | | | 0x03 |
| 0x0368 | W0 | | Nominal period (fs), Bits[39:32] | | | | | | | | 0x00 |
| 0x0369 | W0 | REFD frequency tolerance | Inner tolerance (1 ÷ ppm), Bits[7:0] (for unlock to lock condition; max: 10%, min: 2 ppm) (default: 5%) | | | | | | | | 0x14 |
| 0x036A | W0 | | Inner tolerance (1 ÷ ppm), Bits[15:8] (for unlock to lock condition; max: 10%, min: 2 ppm) | | | | | | | | 0x00 |
| 0x036B | W0 | | Reserved | | | | Inner tolerance, Bits[19:16] | | | | 0x00 |
| 0x036C | W0 | | Outer tolerance (1 ÷ ppm), Bits[7:0] (for lock to unlock; max: 10%, min: 2 ppm) (default: 10%) | | | | | | | | 0x0A |
| 0x036D | W0 | | Outer tolerance (1 ÷ ppm), Bits[15:8] (for lock to unlock; max: 10%, min: 2 ppm) | | | | | | | | 0x00 |
| 0x036E | W0 | | Reserved | | | | Outer tolerance, Bits[19:16] | | | | 0x00 |

| Reg Addr (Hex) | Opt | Name | D7 | D6 | D5 | D4 | D3 | D2 | D1 | D0 | Def (Hex) |
|---|-----|---|---|--|----|------------------------|--|---------------------|-----------------|------|-----------------------|
| 0x036F | W0 | REFD validation | Validation timer (ms), Bits[7:0] (up to 65.5 sec) | | | | | | | | 0x0A |
| 0x0370 | W0 | | Validation timer (ms), Bits[15:8] (up to 65.5 sec) | | | | | | | | 0x00 |
| 0x0371 | W1 | REFD phase lock detector | Phase lock threshold (ps), Bits[7:0] | | | | | | | | 0xBC |
| 0x0372 | W1 | | Phase lock threshold (ps), Bits[15:8] | | | | | | | | 0x02 |
| 0x0373 | W1 | | Phase lock threshold (ps), Bits [23:16] | | | | | | | | 0x00 |
| 0x0374 | W1 | | Phase lock fill rate, Bits[7:0] | | | | | | | | 0x0A |
| 0x0375 | W1 | | Phase lock drain rate, Bits[7:0] | | | | | | | | 0x0A |
| 0x0376 | W1 | REFD frequency lock detector | Frequency lock threshold, Bits[7:0] | | | | | | | | 0xBC |
| 0x0377 | W1 | | Frequency lock threshold, Bits[15:8] | | | | | | | | 0x02 |
| 0x0378 | W1 | | Frequency lock threshold, Bits[23:16] | | | | | | | | 0x00 |
| 0x0379 | W1 | | Frequency lock fill rate, Bits[7:0] | | | | | | | | 0x0A |
| 0x037A | W1 | | Frequency lock drain rate, Bits[7:0] | | | | | | | | 0x0A |
| DPLL_0 General Settings | | | | | | | | | | | |
| 0x0400 | | DPLL_0 free run frequency TW | 30-bit free running frequency tuning word, Bits[7:0] | | | | | | | | 0x12 |
| 0x0401 | | | 30-bit free running frequency tuning word, Bits[15:8] | | | | | | | | 0x15 |
| 0x0402 | | | 30-bit free running frequency tuning word, Bits[23:16] | | | | | | | | 0x64 |
| 0x0403 | | | Reserved | 30-bit free running frequency tuning word, Bits[29:24] | | | | | | | 0x1B |
| 0x0404 | | DCO_0 control | Reserved | | | | Digital oscillator SDM integer part, Bits[3:0] | | | | 0x08 |
| 0x0405 | | DPLL_0 frequency clamp | Lower limit of pull-in range, Bits[7:0] | | | | | | | | 0x51 |
| 0x0406 | | | Lower limit of pull-in range, Bits[15:8] | | | | | | | | 0xB8 |
| 0x0407 | | | Reserved | | | | Lower limit of pull-in range, Bits[19:16] | | | | 0x02 |
| 0x0408 | | | Upper limit of pull-in range, Bits[7:0] | | | | | | | | 0x3E |
| 0x0409 | | | Upper limit of pull-in range, Bits[15:8] | | | | | | | | 0x0A |
| 0x040A | | | Reserved | | | | Upper limit of pull-in range, Bits[19:16] | | | | 0x0B |
| 0x040B | | DPLL_0 holdover history | History accumulation timer (ms), Bits[7:0] (up to 65 sec) | | | | | | | | 0x0A |
| 0x040C | | | History accumulation timer (ms), Bits[15:8] (up to 65 sec) | | | | | | | | 0x00 |
| 0x040D | | DPLL_0 history mode | Reserved | | | Single sample fallback | Persistent history | Incremental average | | | 0x00 |
| 0x040E | | DPLL_0 closed loop phase offset (±0.5 ms) | Fixed phase offset (signed; ps), Bits[7:0] | | | | | | | | 0x00 |
| 0x040F | | | Fixed phase offset (signed; ps), Bits[15:8] | | | | | | | | 0x00 |
| 0x0410 | | | Fixed phase offset (signed; ps), Bits[23:16] | | | | | | | | 0x00 |
| 0x0411 | | | Reserved | Fixed phase offset (signed; ps), Bits[29:24] | | | | | | | 0x00 |
| 0x0412 | | | Incremental phase offset step size (ps/step), Bits[7:0] (up to 65.5 ns/step) | | | | | | | | 0x00 |
| 0x0413 | | | Incremental phase offset step size (ps/step), Bits[15:8] (up to 65.5 ns/step) | | | | | | | | 0x00 |
| 0x0414 | | DPLL_0 phase slew limit | Phase slew rate limit (µs/sec), Bits[7:0] (315 µs/sec up to 65.536 ms/sec) | | | | | | | | 0x00 |
| 0x0415 | | | Phase slew rate Limit (µs/sec), Bits[15:8] (315 µs/sec up to 65.536 ms/sec) | | | | | | | | 0x00 |
| Output PLL_0 (APLL_0) and Channel 0 Output Drivers | | | | | | | | | | | |
| 0x0420 | | APLL_0 charge pump | Output PLL0 (APLL_0) charge pump current, Bits[7:0] | | | | | | | | 0x81 |
| 0x0421 | | APLL_0 M0 divider | Output PLL0 (APLL_0) feedback (M0) divider, Bits[7:0] | | | | | | | | 0x14 |
| 0x0422 | | APLL_0 loop filter control | APLL_0 loop filter control, Bits[7:0] | | | | | | | | 0x07 |
| 0x0423 | | | Reserved | | | | | | | | Bypass internal Rzero |
| 0x0424 | | P0 divider | Reserved | | | | P0 divider divide ratio, Bits[3:0] | | | | 0x04 |
| 0x0425 | | OUT0 sync | Reserved | | | | Sync source selection | | Auto sync mode | | 0x00 |
| 0x0426 | | | Reserved | | | | APLL_0 locked controlled sync disable | Mask OUT0B sync | Mask OUT0A sync | 0x00 | |

| Reg Addr (Hex) | Opt | Name | D7 | D6 | D5 | D4 | D3 | D2 | D1 | D0 | Def (Hex) | |
|--|-----|--|---|--|-------------------------------|-------------------------------|---------------------------|---------------------------|------------------|-------------------------|---|------|
| 0x0427 | | OUT0A | Reserved | OUT0A format, Bits[2:0] | | | OUT0A polarity, Bits[1:0] | | OUT0A LVDS boost | Reserved | 0x10 | |
| 0x0428 | | | Q0_A divider, Bits[7:0] | | | | | | | | 0x00 | |
| 0x0429 | | | Reserved | | | | | | | | Q0_A divider, Bits[9:8] | 0x00 |
| 0x042A | | | Reserved | | | Q0_A divider phase, Bits[5:0] | | | | | 0x00 | |
| 0x042B | | | OUT0B | Enable 3.3 V CMOS driver | OUT0B format[2:0] | | | OUT0B polarity, Bits[1:0] | | OUT0B LVDS boost | Reserved | 0x10 |
| 0x042C | | Q0_B divider, Bits[7:0] | | | | | | | | 0x03 | | |
| 0x042D | | Reserved | | | | | | | | Q0_B divider, Bits[9:8] | 0x00 | |
| 0x042E | | Reserved | | | Q0_B divider phase, Bits[5:0] | | | | | 0x00 | | |
| DPLL_0 Settings for Reference Input A | | | | | | | | | | | | |
| 0x0440 | | Reference priority | Reserved | | | | | REFA priority, Bits[1:0] | | Enable REFA | 0x01 | |
| 0x0441 | W2 | DPLL_0 loop BW (16 bits) | Digital PLL_0 loop BW scaling factor, Bits[7:0] (default: 0x01F4 = 50 Hz) | | | | | | | | | 0xF4 |
| 0x0442 | W2 | | Digital PLL_0 loop BW scaling factor, Bits[15:8] | | | | | | | | | 0x01 |
| 0x0443 | W2 | | Reserved | | | | | | | Base filter | Reserved | 0x00 |
| 0x0444 | W2 | DPLL_0 N0 divider (17 bits) | Digital PLL feedback divider—Integer Part N0, Bits[7:0] | | | | | | | | | 0xCB |
| 0x0445 | W2 | | Digital PLL feedback divider—Integer Part N0, Bits[15:8] | | | | | | | | | 0x07 |
| 0x0446 | W2 | | Reserved | | | | | | | | Digital PLL feedback divider, Integer Part N0, Bit 16 | 0x00 |
| 0x0447 | | DPLL_0 fractional feedback divider (23 bits) | Digital PLL fractional feedback divider—FRAC0, Bits[7:0] | | | | | | | | | 0x04 |
| 0x0448 | | | Digital PLL fractional feedback divider—FRAC0, Bits[15:8] | | | | | | | | | 0x00 |
| 0x0449 | | | Reserved | Digital PLL fractional feedback divider—FRAC0, Bits[22:16] | | | | | | | | 0x00 |
| 0x044A | W2 | DPLL_0 fractional feedback divider modulus (23 bits) | Digital PLL feedback divider modulus—MOD0, Bits[7:0] | | | | | | | | | 0x05 |
| 0x044B | W2 | | Digital PLL feedback divider modulus—MOD0, Bits[15:8] | | | | | | | | | 0x00 |
| 0x044C | W2 | | Reserved | Digital PLL feedback divider modulus—MOD0, Bits[22:16] | | | | | | | | 0x00 |
| DPLL_0 Settings for Reference Input B | | | | | | | | | | | | |
| 0x044D | | Reference priority | Reserved | | | | | REFB priority, Bits[1:0] | | Enable REFB | 0x01 | |
| 0x044E | W2 | DPLL_0 loop BW (16 bits) | Digital PLL_0 loop BW scaling factor, Bits[7:0] (default: 0x01F4 = 50 Hz) | | | | | | | | | 0xF4 |
| 0x044F | W2 | | Digital PLL_0 loop BW scaling factor, Bits[15:8] | | | | | | | | | 0x01 |
| 0x0450 | W2 | | Reserved | | | | | | | Base filter | Reserved | 0x00 |
| 0x0451 | W2 | DPLL_0 N0 divider (17 bits) | Digital PLL feedback divider—Integer Part N0, Bits[7:0] | | | | | | | | | 0xCB |
| 0x0452 | W2 | | Digital PLL feedback divider—Integer Part N0, Bits[15:8] | | | | | | | | | 0x07 |
| 0x0453 | W2 | | Reserved | | | | | | | | Digital PLL feedback divider, Integer Part N0, Bit 16 | 0x00 |
| 0x0454 | | DPLL_0 fractional feedback divider (23 bits) | Digital PLL fractional feedback divider—FRAC0, Bits[7:0] | | | | | | | | | 0x04 |
| 0x0455 | | | Digital PLL fractional feedback divider—FRAC0, Bits[15:8] | | | | | | | | | 0x00 |
| 0x0456 | | | Reserved | Digital PLL fractional feedback divider—FRAC0, Bits[22:16] | | | | | | | | 0x00 |
| 0x0457 | W2 | DPLL_0 fractional feedback divider modulus (23 bits) | Digital PLL feedback divider modulus—MOD0, Bits[7:0] | | | | | | | | | 0x05 |
| 0x0458 | W2 | | Digital PLL feedback divider modulus—MOD0, Bits[15:8] | | | | | | | | | 0x00 |
| 0x0459 | W2 | | Reserved | Digital PLL feedback divider modulus—MOD0, Bits[22:16] | | | | | | | | 0x00 |

| Reg Addr (Hex) | Opt | Name | D7 | D6 | D5 | D4 | D3 | D2 | D1 | D0 | Def (Hex) | |
|--|-----|--|---|--|----|----|----|--|---|-------------|-----------|--|
| DPLL_0 Settings for Reference Input C | | | | | | | | | | | | |
| 0x045A | | Reference priority | Reserved | | | | | REFC priority, Bits[1:0] | | Enable REFC | 0x00 | |
| 0x045B | W2 | DPLL_0 loop BW (16 bits) | Digital PLL_0 loop BW scaling factor, Bits[7:0] (default: 0x01F4 = 50 Hz) | | | | | | | | | 0xF4 |
| 0x045C | W2 | | Digital PLL_0 loop BW scaling factor, Bits[15:8] | | | | | | | | | 0x01 |
| 0x045D | W2 | | Reserved | | | | | | Base filter | Reserved | | 0x00 |
| 0x045E | W2 | DPLL_0 N0 divider (17 bits) | Digital PLL feedback divider—Integer Part N0, Bits[7:0] | | | | | | | | | 0xCB |
| 0x045F | W2 | | Digital PLL feedback divider—Integer Part N0, Bits[15:8] | | | | | | | | | 0x07 |
| 0x0460 | W2 | | Reserved | | | | | | | | | Digital PLL feedback divider—Integer Part N0, Bit 16 |
| 0x0461 | | DPLL_0 fractional feedback divider (23 bits) | Digital PLL fractional feedback divider—FRAC0, Bits[7:0] | | | | | | | | | 0x04 |
| 0x0462 | | | Digital PLL fractional feedback divider—FRAC0, Bits[15:8] | | | | | | | | | 0x00 |
| 0x0463 | | | Reserved | Digital PLL fractional feedback divider—FRAC0, Bits[22:16] | | | | | | | | |
| 0x0464 | W2 | DPLL_0 fractional feedback divider modulus (23 bits) | Digital PLL feedback divider modulus—MOD0, Bits[7:0] | | | | | | | | | 0x05 |
| 0x0465 | W2 | | Digital PLL feedback divider modulus—MOD0, Bits[15:8] | | | | | | | | | 0x00 |
| 0x0466 | W2 | | Reserved | Digital PLL feedback divider modulus—MOD0, Bits[22:16] | | | | | | | | |
| DPLL_0 Settings for Reference Input D | | | | | | | | | | | | |
| 0x0467 | | Reference priority | Reserved | | | | | REFD priority, Bits[1:0] | | Enable REFD | 0x00 | |
| 0x0468 | W2 | DPLL_0 loop BW (16 bits) | Digital PLL_0 loop BW scaling factor, Bits[7:0] (default: 0x01F4 = 50 Hz) | | | | | | | | | 0xF4 |
| 0x0469 | W2 | | Digital PLL_0 loop BW scaling factor, Bits[15:8] | | | | | | | | | 0x01 |
| 0x046A | W2 | | Reserved | | | | | | Base filter | Reserved | | 0x00 |
| 0x046B | W2 | DPLL_0 N0 divider (17 bits) | Digital PLL feedback divider—Integer Part N0, Bits[7:0] | | | | | | | | | 0xCB |
| 0x046C | W2 | | Digital PLL feedback divider—Integer Part N0, Bits[15:8] | | | | | | | | | 0x07 |
| 0x046D | W2 | | Reserved | | | | | | | | | Digital PLL feedback divider—Integer Part N0, Bit 16 |
| 0x046E | | DPLL_0 fractional feedback divider (23 bits) | Digital PLL fractional feedback divider—FRAC0, Bits[7:0] | | | | | | | | | 0x04 |
| 0x046F | | | Digital PLL fractional feedback divider—FRAC0, Bits[15:8] | | | | | | | | | 0x00 |
| 0x0470 | | | Reserved | Digital PLL fractional feedback divider—FRAC0, Bits[22:16] | | | | | | | | |
| 0x0471 | W2 | DPLL_0 fractional feedback divider modulus (23 bits) | Digital PLL feedback divider modulus—MOD0, Bits[7:0] | | | | | | | | | 0x05 |
| 0x0472 | W2 | | Digital PLL feedback divider modulus—MOD0, Bits[15:8] | | | | | | | | | 0x00 |
| 0x0473 | W2 | | Reserved | Digital PLL feedback divider modulus—MOD0, Bits[22:16] | | | | | | | | |
| DPLL_1 General Settings | | | | | | | | | | | | |
| 0x0500 | | DPLL_1 free run frequency TW | 30-bit free running frequency tuning word, Bits[7:0] | | | | | | | | | 0x12 |
| 0x0501 | | | 30-bit free running frequency tuning word, Bits[15:8] | | | | | | | | | 0x15 |
| 0x0502 | | | 30-bit free running frequency tuning word, Bits[23:16] | | | | | | | | | 0x64 |
| 0x0503 | | | Reserved | 30-bit free running frequency tuning word, Bits[29:24] | | | | | | | | |
| 0x0504 | | DCO_1 control | Reserved | | | | | Digital oscillator SDM integer part, Bits[3:0] | | | | 0x08 |
| 0x0505 | | DPLL_1 frequency clamp | Lower limit of pull-in range, Bits[7:0] | | | | | | | | | 0x51 |
| 0x0506 | | | Lower limit of pull-in range, Bits[15:8] | | | | | | | | | 0xB8 |
| 0x0507 | | | Reserved | | | | | | Lower limit of pull-in range, Bits[19:16] | | | 0x02 |
| 0x0508 | | | Upper limit of pull-in range, Bits[7:0] | | | | | | | | | 0x3E |
| 0x0509 | | | Upper limit of pull-in range, Bits[15:8] | | | | | | | | | 0x0A |
| 0x050A | | | Reserved | | | | | | Upper limit of pull-in range, Bits[19:16] | | | 0x0B |

| Reg Addr (Hex) | Opt | Name | D7 | D6 | D5 | D4 | D3 | D2 | D1 | D0 | Def (Hex) | |
|---|-----|---|---|--|----|-------------------------------|---------------------------------------|---------------------|------------------|----------|--|------|
| 0x050B | | DPLL_1 holdover history | History accumulation timer (ms), Bits[7:0] (up to 65 sec) | | | | | | | | 0x0A | |
| 0x050C | | | History accumulation timer (ms), Bits[15:8] (up to 65 sec) | | | | | | | | 0x00 | |
| 0x050D | | DPLL_1 history mode | Reserved | | | Single sample fallback | Persistent history | Incremental average | | | 0x00 | |
| 0x050E | | DPLL_1 closed loop phase offset [±0.5 ms] | Fixed phase offset (signed; ps), Bits[7:0] | | | | | | | | 0x00 | |
| 0x050F | | | Fixed phase offset (signed; ps), Bits[15:8] | | | | | | | | 0x00 | |
| 0x0510 | | | Fixed phase offset (signed; ps), Bits[23:16] | | | | | | | | 0x00 | |
| 0x0511 | | | Reserved | Fixed phase offset (signed; ps), Bits[29:24] | | | | | | | | 0x00 |
| 0x0512 | | | Incremental phase offset step size (ps/step), Bits[7:0] (up to 65.5 ns/step) | | | | | | | | 0x00 | |
| 0x0513 | | | Incremental phase offset step size (ps/step), Bits[15:8] (up to 65.5 ns/step) | | | | | | | | 0x00 | |
| 0x0514 | | DPLL_1 phase slew limit | Phase slew rate limit (µs/sec), Bits[7:0] (315 µs/sec up to 65.536 ms/sec) | | | | | | | | 0x00 | |
| 0x0515 | | | Phase slew rate Limit (µs/sec), Bits[15:8] (315 µs/sec up to 65.536 ms/sec) | | | | | | | | 0x00 | |
| Output PLL_1 (APLL_1) and Channel 1 Output Drivers | | | | | | | | | | | | |
| 0x0520 | | APLL_1 charge pump | Output PLL1 (APLL_1) charge pump current, Bits[7:0] | | | | | | | | 0x81 | |
| 0x0521 | | APLL_1 M1 divider | Output PLL0 (APLL_1) feedback (M1) divider, Bits[7:0] | | | | | | | | 0x14 | |
| 0x0522 | | APLL_1 loop filter control | APLL_1 loop filter control, Bits[7:0] | | | | | | | | 0x07 | |
| 0x0523 | | | Reserved | | | | | | | | Bypass internal Rzero | 0x00 |
| 0x0524 | | P1 divider | Reserved | | | | P1 divider divide ratio, Bits[3:0] | | | | 0x04 | |
| 0x0525 | | OUT1 sync | Reserved | | | | Sync source selection | Auto sync mode | | | | 0x00 |
| 0x0526 | | | Reserved | | | | APLL_1 locked controlled sync disable | Mask OUT1B sync | Mask OUT1A sync | | 0x00 | |
| 0x0527 | | OUT1A | Reserved | OUT1A format, Bits[2:0] | | | OUT1A polarity, Bits[1:0] | | OUT1A LVDS boost | Reserved | | 0x10 |
| 0x0528 | | | Q1_A divider, Bits[7:0] | | | | | | | | 0x00 | |
| 0x0529 | | | Reserved | | | | Q1_A divider, Bits[9:8] | | | | 0x00 | |
| 0x052A | | | Reserved | | | Q1_A divider phase, Bits[5:0] | | | | | 0x00 | |
| 0x052B | | OUT1B | Enable 3.3 V CMOS driver | OUT1B format, Bits[2:0] | | | OUT1B polarity, Bits[1:0] | | OUT1B LVDS boost | Reserved | | 0x10 |
| 0x052C | | | Q1_B divider, Bits[7:0] | | | | | | | | 0x03 | |
| 0x052D | | | Reserved | | | | Q1_B divider, Bits[9:8] | | | | 0x00 | |
| 0x052E | | | Reserved | | | Q1_B divider phase, Bits[5:0] | | | | | 0x00 | |
| DPLL_1 Settings for Reference Input C | | | | | | | | | | | | |
| 0x0540 | | Reference priority | Reserved | | | | REFC priority, Bits[1:0] | | Enable REFC | | 0x01 | |
| 0x0541 | W2 | DPLL_1 loop BW (16 bits) | Digital PLL_1 loop BW scaling factor, Bits[7:0] (default: 0x01F4 = 50 Hz) | | | | | | | | 0xF4 | |
| 0x0542 | W2 | | Digital PLL_1 loop BW scaling factor, Bits[15:8] | | | | | | | | 0x01 | |
| 0x0543 | W2 | | Reserved | | | | | | Base filter | Reserved | | 0x00 |
| 0x0544 | W2 | DPLL_1 N1 divider (17 bits) | Digital PLL_1 feedback divider—Integer Part N1, Bits[7:0] | | | | | | | | 0xCB | |
| 0x0545 | W2 | | Digital PLL_1 feedback divider—Integer Part N1, Bits[15:8] | | | | | | | | 0x07 | |
| 0x0546 | W2 | | Reserved | | | | | | | | Digital PLL feedback divider—Integer Part N1, Bit 16 | 0x00 |
| 0x0547 | | | DPLL_1 fractional feedback divider (23 bits) | Digital PLL_1 fractional feedback divider—FRAC1, Bits[7:0] | | | | | | | | 0x04 |
| 0x0548 | | Digital PLL_1 fractional feedback divider—FRAC1, Bits[15:8] | | | | | | | | 0x00 | | |
| 0x0549 | | Reserved | | Digital PLL_1 fractional feedback divider—FRAC1, Bits[22:16] | | | | | | | | 0x00 |

| Reg Addr (Hex) | Opt | Name | D7 | D6 | D5 | D4 | D3 | D2 | D1 | D0 | Def (Hex) |
|--|-----|--|---|--|----|----|----|--------------------------|-------------|-------------|--|
| 0x054A | W2 | DPLL_1 fractional feedback divider modulus (23 bits) | Digital PLL_1 feedback divider modulus—MOD1, Bits[7:0] | | | | | | | | 0x05 |
| 0x054B | W2 | | Digital PLL_1 feedback divider modulus—MOD1, Bits[15:8] | | | | | | | | 0x00 |
| 0x054C | W2 | | Reserved | Digital PLL_1 feedback divider modulus—MOD1, Bits[22:16] | | | | | | | 0x00 |
| DPLL_1 Settings for Reference Input D | | | | | | | | | | | |
| 0x054D | | Reference priority | Reserved | | | | | REFD priority, Bits[1:0] | | Enable REFD | 0x01 |
| 0x054E | W2 | DPLL_1 loop BW (16 bits) | Digital PLL_1 loop BW scaling factor, Bits[7:0] (default: 0x01F4 = 50 Hz) | | | | | | | | 0xF4 |
| 0x054F | W2 | | Digital PLL_1 loop BW scaling factor, Bits[15:8] | | | | | | | | 0x01 |
| 0x0550 | W2 | | Reserved | | | | | | Base filter | Reserved | 0x00 |
| 0x0551 | W2 | DPLL_1 N1 divider (17 bits) | Digital PLL_1 feedback divider—Integer Part N1, Bits[7:0] | | | | | | | | 0xCB |
| 0x0552 | W2 | | Digital PLL_1 feedback divider—Integer Part N1, Bits[15:8] | | | | | | | | 0x07 |
| 0x0553 | W2 | | Reserved | | | | | | | | Digital PLL feedback divider—Integer Part N1, Bit 16 |
| 0x0554 | | DPLL_1 fractional feedback divider (23 bits) | Digital PLL_1 fractional feedback divider—FRAC1, Bits[7:0] | | | | | | | | 0x04 |
| 0x0555 | | | Digital PLL_1 fractional feedback divider—FRAC1, Bits[15:8] | | | | | | | | 0x00 |
| 0x0556 | | | Reserved | Digital PLL_1 fractional feedback divider—FRAC1, Bits[22:16] | | | | | | | 0x00 |
| 0x0557 | W2 | DPLL_1 fractional feedback divider modulus (23 bits) | Digital PLL_1 feedback divider modulus—MOD1, Bits[7:0] | | | | | | | | 0x05 |
| 0x0558 | W2 | | Digital PLL_1 feedback divider modulus—MOD1, Bits[15:8] | | | | | | | | 0x00 |
| 0x0559 | W2 | | Reserved | Digital PLL_1 feedback divider modulus—MOD1, Bits[22:16] | | | | | | | 0x00 |
| DPLL_1 Settings for Reference Input A | | | | | | | | | | | |
| 0x055A | | Reference priority | Reserved | | | | | REFA priority, Bits[1:0] | | Enable REFA | 0x00 |
| 0x055B | W2 | DPLL_1 loop BW (16 bits) | Digital PLL_1 loop BW scaling factor, Bits[7:0] (default: 0x01F4 = 50 Hz) | | | | | | | | 0xF4 |
| 0x055C | W2 | | Digital PLL_1 loop BW scaling factor, Bits[15:8] | | | | | | | | 0x01 |
| 0x055D | W2 | | Reserved | | | | | | Base filter | Reserved | 0x00 |
| 0x055E | W2 | DPLL_1 N1 divider (17 bits) | Digital PLL_1 feedback divider—Integer Part N1, Bits[7:0] | | | | | | | | 0xCB |
| 0x055F | W2 | | Digital PLL_1 feedback divider—Integer Part N1, Bits[15:8] | | | | | | | | 0x07 |
| 0x0560 | W2 | | Reserved | | | | | | | | Digital PLL feedback divider—Integer Part N1, Bit 16 |
| 0x0561 | | DPLL_1 fractional feedback divider (23 bits) | Digital PLL_1 fractional feedback divider—FRAC1, Bits[7:0] | | | | | | | | 0x04 |
| 0x0562 | | | Digital PLL_1 fractional feedback divider—FRAC1, Bits[15:8] | | | | | | | | 0x00 |
| 0x0563 | | | Reserved | Digital PLL_1 fractional feedback divider—FRAC1, Bits[22:16] | | | | | | | 0x00 |
| 0x0564 | W2 | DPLL_1 fractional feedback divider modulus (23 bits) | Digital PLL_1 feedback divider modulus—MOD1, Bits[7:0] | | | | | | | | 0x05 |
| 0x0565 | W2 | | Digital PLL_1 feedback divider modulus—MOD1, Bits[15:8] | | | | | | | | 0x00 |
| 0x0566 | W2 | | Reserved | Digital PLL_1 feedback divider modulus—MOD1, Bits[22:16] | | | | | | | 0x00 |

| Reg Addr (Hex) | Opt | Name | D7 | D6 | D5 | D4 | D3 | D2 | D1 | D0 | Def (Hex) | |
|--|-----|---|---|--|----|----|---------------------|---------------------|---------------------|---------------------|--|------|
| DPLL_1 Settings for Reference Input B | | | | | | | | | | | | |
| 0x0567 | | Reference priority | Reserved | | | | | REFB priority [1:0] | | Enable REFB | 0x00 | |
| 0x0568 | W2 | DPLL_1 loop BW (16 bits) | Digital PLL_1 loop BW scaling factor, Bits[7:0] (default: 0x01F4 = 50 Hz) | | | | | | | | | 0xF4 |
| 0x0569 | W2 | | Digital PLL_1 loop BW scaling factor, Bits[15:8] | | | | | | | | | 0x01 |
| 0x056A | W2 | DPLL_1 N1 divider (17 bits) | Reserved | | | | | | Base filter | Reserved | | 0x00 |
| 0x056B | W2 | | Digital PLL_1 feedback divider—Integer Part N1, Bits[7:0] | | | | | | | | | 0xCB |
| 0x056C | W2 | | Digital PLL_1 feedback divider—Integer Part N1, Bits[15:8] | | | | | | | | | 0x07 |
| 0x056D | W2 | | Reserved | | | | | | | | Digital PLL feedback divider—Integer Part N1, Bit 16 | 0x00 |
| 0x056E | | DPLL_1 fractional feedback divider (23 bits) | Digital PLL_1 fractional feedback divider—FRAC1, Bits[7:0] | | | | | | | | | 0x04 |
| 0x056F | | | Digital PLL_1 fractional feedback divider—FRAC1, Bits[15:8] | | | | | | | | | 0x00 |
| 0x0570 | | | Reserved | Digital PLL_1 fractional feedback divider—FRAC1, Bits[22:16] | | | | | | | 0x00 | |
| 0x0571 | W2 | DPLL_1 fractional feedback divider modulus (23 bits) | Digital PLL_1 feedback divider modulus—MOD1, Bits[7:0] | | | | | | | | | 0x05 |
| 0x0572 | W2 | | Digital PLL_1 feedback divider modulus—MOD1, Bits[15:8] | | | | | | | | | 0x00 |
| 0x0573 | W2 | | Reserved | Digital PLL_1 feedback divider modulus—MOD1, Bits[22:16] | | | | | | | 0x00 | |
| Loop Filters | | | | | | | | | | | | |
| 0x0800 | L | Base loop filter coefficient set (normal phase margin of 70°) | NPM Alpha-0 linear, Bits[7:0] | | | | | | | | | 0x24 |
| 0x0801 | L | | NPM Alpha-0 linear, Bits[15:8] | | | | | | | | | 0x8C |
| 0x0802 | L | | Reserved | NPM Alpha-1 exponent, Bits[6:0] | | | | | | | 0x49 | |
| 0x0803 | L | | NPM Beta-0 linear, Bits[7:0] | | | | | | | | | 0x55 |
| 0x0804 | L | | NPM Beta-0 linear, Bits[15:8] | | | | | | | | | 0xC9 |
| 0x0805 | L | | Reserved | NPM Beta-1 exponent, Bits[6:0] | | | | | | | 0x7B | |
| 0x0806 | L | | NPM Gamma-0 linear, Bits[7:0] | | | | | | | | | 0x9C |
| 0x0807 | L | | NPM Gamma-0 linear, Bits[15:8] | | | | | | | | | 0xFA |
| 0x0808 | L | | Reserved | NPM Gamma-1 exponent, Bits[6:0] | | | | | | | 0x55 | |
| 0x0809 | L | | NPM Delta-0 linear, Bits[7:0] | | | | | | | | | 0xEA |
| 0x080A | L | NPM Delta-0 linear, Bits[15:8] | | | | | | | | | 0xE2 | |
| 0x080B | L | Reserved | NPM Delta-1 exponent, Bits[6:0] | | | | | | | 0x57 | | |
| 0x080C | L | Base loop filter coefficient set (high phase margin) | HPM Alpha-0 linear, Bits[7:0] | | | | | | | | | 0x8C |
| 0x080D | L | | HPM Alpha-0 linear, Bits[15:8] | | | | | | | | | 0xAD |
| 0x080E | L | | Reserved | HPM Alpha-1 exponent, Bits[6:0] | | | | | | | 0x4C | |
| 0x080F | L | | HPM Beta-0 linear, Bits[7:0] | | | | | | | | | 0xF5 |
| 0x0810 | L | | HPM Beta-0 linear, Bits[15:8] | | | | | | | | | 0xCB |
| 0x0811 | L | | Reserved | HPM Beta-1 exponent, Bits[6:0] | | | | | | | 0x73 | |
| 0x0812 | L | | HPM Gamma-0 linear, Bits[7:0] | | | | | | | | | 0x24 |
| 0x0813 | L | | HPM Gamma-0 linear, Bits[15:8] | | | | | | | | | 0xD8 |
| 0x0814 | L | | Reserved | HPM Gamma-1 exponent, Bits[6:0] | | | | | | | 0x59 | |
| 0x0815 | L | | HPM Delta-0 linear, Bits[7:0] | | | | | | | | | 0xD2 |
| 0x0816 | L | HPM Delta-0 linear, Bits[15:8] | | | | | | | | | 0x8D | |
| 0x0817 | L | Reserved | HPM Delta-1 exponent, Bits[6:0] | | | | | | | 0x5A | | |
| Common Operational Controls | | | | | | | | | | | | |
| 0x0A00 | L | Global | Reserved | | | | | Soft sync all | Calibrate all | Power-down all | 0x00 | |
| 0x0A01 | | Reference inputs | Reserved | | | | REFD power-down | REFC power-down | REFB power-down | REFA power-down | 0x00 | |
| 0x0A02 | A | | Reserved | | | | REFD timeout | REFC timeout | REFB timeout | REFA timeout | 0x00 | |
| 0x0A03 | | | Reserved | | | | REFD fault | REFC fault | REFB fault | REFA fault | 0x00 | |
| 0x0A04 | | | Reserved | | | | REFD monitor bypass | REFC monitor bypass | REFB monitor bypass | REFA monitor bypass | 0x00 | |

| Reg Addr (Hex) | Opt | Name | D7 | D6 | D5 | D4 | D3 | D2 | D1 | D0 | Def (Hex) |
|----------------|-----|------------------|----------------------|-------------------|----------------------|--------------------|--------------------|-------------------|--------------------|--------------------|-----------|
| 0x0A05 | A | Clear IRQ groups | Clear watchdog timer | Reserved | | | Clear DPLL_1 IRQs | Clear DPLL_0 IRQs | Clear common IRQs | Clear all IRQs | 0x00 |
| 0x0A06 | A | Clear common IRQ | Reserved | SYSCLK unlocked | SYSCLK stable | SYSCLK locked | Watchdog timer | Reserved | EEPROM fault | EEPROM complete | 0x00 |
| 0x0A07 | A | | Reserved | REFB validated | REFB fault cleared | REFB fault | Reserved | REFA validated | REFA fault cleared | REFA fault | 0x00 |
| 0x0A08 | A | | Reserved | REFD validated | REFD fault cleared | REFD fault | Reserved | REFC validated | REFC fault cleared | REFC fault | 0x00 |
| 0x0A09 | A | Clear DPLL_0 IRQ | Frequency unclamped | Frequency clamped | Phase slew unlimited | Phase slew limited | Frequency unlocked | Frequency locked | Phase unlocked | Phase locked | 0x00 |
| 0x0A0A | A | | DPLL_0 switching | DPLL_0 free run | DPLL_0 holdover | History updated | REFD activated | REFC activated | REFB activated | REFA activated | 0x00 |
| 0x0A0B | A | | Reserved | | | Clock dist sync'd | APLL_0 unlocked | APLL_0 locked | APLL_0 cal ended | APLL_0 cal started | 0x00 |
| 0x0A0C | A | Clear DPLL_1 IRQ | Frequency unclamped | Frequency clamped | Phase slew unlimited | Phase slew limited | Frequency unlocked | Frequency locked | Phase unlocked | Phase locked | 0x00 |
| 0x0A0D | A | | DPLL_1 switching | DPLL_1 free run | DPLL_1 holdover | History updated | REFD activated | REFC activated | REFB activated | REFA activated | 0x00 |
| 0x0A0E | A | | Reserved | | | Clock dist sync'd | APLL_1 unlocked | APLL_1 locked | APLL_1 cal ended | APLL_1 cal started | 0x00 |

PLL_0 Operational Controls

| | | | | | | | | | | | |
|--------|---|-----------------|----------|------------------------------------|--|----------------------------------|---------------|---------------------------|----------------------------------|-------------------------------|------|
| 0x0A20 | | PLL_0 sync cal | Reserved | | | | | APLL_0 soft sync | APLL_0 calibrate (no self clear) | PLL_0 power-down | 0x00 |
| 0x0A21 | | PLL_0 output | Reserved | | | | OUT0B disable | OUT0A disable | OUT0B power-down | OUT0A power-down | 0x00 |
| 0x0A22 | | PLL_0 user mode | Reserved | DPLL_0 manual reference, Bits[1:0] | | DPLL_0 switching mode, Bits[2:0] | | DPLL_0 user holdover | DPLL_0 user free run | 0x00 | |
| 0x0A23 | A | PLL_0 reset | Reserved | | | | | Reset DPLL_0 loop filter | Reset DPLL_0 TW history | Reset DPLL_0 auto sync | 0x00 |
| 0x0A24 | A | PLL_0 phase | Reserved | | | | | DPLL_0 reset phase offset | DPLL_0 decrement phase offset | DPLL_0 increment phase offset | 0x00 |

PLL_1 Operational Controls

| | | | | | | | | | | | |
|--------|---|-----------------|----------|------------------------------------|--|----------------------------------|---------------|---------------------------|----------------------------------|-------------------------------|------|
| 0x0A40 | | PLL_1 sync cal | Reserved | | | | | APLL_1 soft sync | APLL_1 calibrate (no self clear) | PLL_1 power-down | 0x00 |
| 0x0A41 | | PLL_1 output | Reserved | | | | OUT1B disable | OUT1A disable | OUT1B power-down | OUT1A power-down | 0x00 |
| 0x0A42 | | PLL_1 user mode | Reserved | DPLL_1 manual reference, Bits[1:0] | | DPLL_1 switching mode, Bits[2:0] | | DPLL_1 user holdover | DPLL_1 user free run | 0x00 | |
| 0x0A43 | A | PLL_1 reset | Reserved | | | | | Reset DPLL_1 loop filter | Reset DPLL_1 TW history | Reset DPLL_1 auto sync | 0x00 |
| 0x0A44 | A | PLL_1 phase | Reserved | | | | | DPLL_1 reset phase offset | DPLL_1 decrement phase offset | DPLL_1 increment phase offset | 0x00 |

| Reg Addr (Hex) | Opt | Name | D7 | D6 | D5 | D4 | D3 | D2 | D1 | D0 | Def (Hex) | | | |
|--|------|-------------------------------------|--|--|----------------------|---|---|-----------------------|---|--------------------------|--------------------------|-----|-----|-----|
| Read-Only Status Common Blocks (These registers are accessible during EEPROM transactions. To show the latest status, Register 0x0D02 to Register 0x0D05 require an IO_UPDATE before being read.) | | | | | | | | | | | | | | |
| 0x0D00 | R, L | EEPROM | Reserved | | | | | EEPROM fault detected | EEPROM load in progress | EEPROM save in progress | N/A | | | |
| 0x0D01 | R, L | SYSCLK and PLL status | Reserved | | | | PLL_1 all locked | PLL_0 all locked | SYSCLK stable | SYSCLK lock detect | N/A | | | |
| 0x0D02 | R, L | Reference status | Reserved | DPLL_1 REFA active | DPLL_0 REFA active | REFA valid | REFA fault | REFA fast | REFA slow | N/A | | | | |
| 0x0D03 | R, L | | Reserved | DPLL_1 REFB active | DPLL_0 REFB active | REFB valid | REFB fault | REFB fast | REFB slow | N/A | | | | |
| 0x0D04 | R, L | | Reserved | DPLL_1 REFC active | DPLL_0 REFC active | REFC valid | REFC fault | REFC fast | REFC slow | N/A | | | | |
| 0x0D05 | R, L | | Reserved | DPLL_1 REFD active | DPLL_0 REFD active | REFD valid | REFD fault | REFD fast | REFD slow | N/A | | | | |
| 0x0D06 | R, L | | Reserved | | | | | | | | | N/A | | |
| 0x0D07 | R, L | | Reserved | | | | | | | | | N/A | | |
| IRQ Monitor | | | | | | | | | | | | | | |
| 0x0D08 | R | IRQ, common | Reserved | SYSCLK unlocked | SYSCLK stable | SYSCLK locked | Watchdog timer | Reserved | EEPROM fault | EEPROM complete | N/A | | | |
| 0x0D09 | R | | Reserved | REFB validated | REFB fault cleared | REFB fault | Reserved | REFA validated | REFA fault cleared | REFA fault | N/A | | | |
| 0x0D0A | R | | Reserved | REFD validated | REFD fault cleared | REFD fault | Reserved | REFC validated | REFC fault cleared | REFC fault | N/A | | | |
| 0x0D0B | R | IRQ, DPLL_0 | Frequency unclamped | Frequency clamped | Phase slew unlimited | Phase slew limited | Frequency unlocked | Frequency locked | Phase unlocked | Phase locked | N/A | | | |
| 0x0D0C | R | | DPLL_0 switching | DPLL_0 free run | DPLL_0 holdover | History updated | REFD activated | REFC activated | REFB activated | REFA activated | N/A | | | |
| 0x0D0D | R | | Reserved | | | | Clock dist sync'd | APLL_0 unlocked | APLL_0 locked | APLL_0 cal ended | APLL_0 cal started | N/A | | |
| 0x0D0E | R | IRQ, DPLL_1 | Frequency unclamped | Frequency clamped | Phase slew unlimited | Phase slew limited | Frequency unlocked | Frequency locked | Phase unlocked | Phase locked | N/A | | | |
| 0x0D0F | R | | DPLL_1 switching | DPLL_1 free run | DPLL_1 holdover | History updated | REFD activated | REFC activated | REFB activated | REFA activated | N/A | | | |
| 0x0D10 | R | | Reserved | | | | Clock dist sync'd | APLL_1 unlocked | APLL_1 locked | APLL_1 cal ended | APLL_1 cal started | N/A | | |
| PLL_0 Read-Only Status (To show the latest status, these registers require an IO_UPDATE before being read.) | | | | | | | | | | | | | | |
| 0x0D20 | R, L | PLL_0 lock status | Reserved | | | APLL_0 cal in progress | APLL_0 locked | DPLL_0 freq lock | DPLL_0 phase Lock | PLL_0 all locked | N/A | | | |
| 0x0D21 | R | DPLL_0 loop state | Reserved | | | DPLL_0 active ref, Bits[1:0] | | DPLL_0 switching | DPLL_0 holdover | DPLL_0 free run | N/A | | | |
| 0x0D22 | R, L | | Reserved | | | | | | DPLL_0 phase slew limited | DPLL_0 frequency clamped | DPLL_0 history available | N/A | | |
| 0x0D23 | R | DPLL_0 holdover history | DPLL_0 tuning word readback, Bits[7:0] | | | | | | | | | N/A | | |
| 0x0D24 | R | | DPLL_0 tuning word readback, Bits[15:8] | | | | | | | | | N/A | | |
| 0x0D25 | R | | DPLL_0 tuning word readback, Bits[23:16] | | | | | | | | | N/A | | |
| 0x0D26 | R | | Reserved | DPLL_0 tuning word readback, Bits[29:24] | | | | | | | | | N/A | |
| 0x0D27 | R | DPLL_0 phase lock detect bucket | DPLL_0 phase lock detect bucket level, Bits[7:0] | | | | | | DPLL_0 phase lock detect bucket level, Bits[11:8] | | | | N/A | |
| 0x0D28 | R | | Reserved | | | DPLL_0 phase lock detect bucket level, Bits[11:8] | | | | | | | | |
| 0x0D29 | R | DPLL_0 frequency lock detect bucket | DPLL_0 frequency lock detect bucket level, Bits[7:0] | | | | | | | | | N/A | | |
| 0x0D2A | R | | Reserved | | | | DPLL_0 frequency lock detect bucket level, Bits[11:8] | | | | | | | N/A |

| Reg Addr (Hex) | Opt | Name | D7 | D6 | D5 | D4 | D3 | D2 | D1 | D0 | Def (Hex) | |
|--|------|-------------------------------------|--|--|----|---|------------------------------|---------------------------|--------------------------|--------------------------|-----------|------|
| PLL_1 Read-Only Status (To show the latest status, these registers require an IO_UPDATE before being read.) | | | | | | | | | | | | |
| 0x0D40 | R, L | PLL_1 lock status | Reserved | | | APLL_1 cal in progress | APLL_1 locked | DPLL_1 freq lock | DPLL_1 phase lock | PLL_1 all locked | | N/A |
| 0x0D41 | R | DPLL_1 loop state | Reserved | | | DPLL_1 active ref, Bits[1:0] | | DPLL_1 switching | DPLL_1 holdover | DPLL_1 free run | | N/A |
| 0x0D42 | R, L | | Reserved | | | | | DPLL_1 phase slew limited | DPLL_1 frequency clamped | DPLL_1 history available | | N/A |
| 0x0D43 | R | DPLL_1 holdover history | DPLL_1 tuning word readback, Bits[7:0] | | | | | | | | | N/A |
| 0x0D44 | R | | DPLL_1 tuning word readback, Bits[15:8] | | | | | | | | | N/A |
| 0x0D45 | R | | DPLL_1 tuning word readback, Bits[23:16] | | | | | | | | | N/A |
| 0x0D46 | R | | Reserved | DPLL_1 tuning word readback, Bits[29:24] | | | | | | | | N/A |
| 0x0D47 | R | DPLL_1 phase lock detect bucket | DPLL_1 phase lock detect bucket level, Bits[7:0] | | | | | | | | | N/A |
| 0x0D48 | R | DPLL_1 phase lock detect bucket | Reserved | | | DPLL_1 phase lock detect bucket level, Bits[11:8] | | | | | | N/A |
| 0x0D49 | R | DPLL_1 frequency lock detect bucket | DPLL_1 frequency lock detect bucket level, Bits[7:0] | | | | | | | | | N/A |
| 0x0D4A | R | DPLL_1 frequency lock detect bucket | Reserved | | | DPLL_1 frequency lock detect bucket level, Bits[11:8] | | | | | | N/A |
| Nonvolatile Memory (EEPROM) Control | | | | | | | | | | | | |
| 0x0E00 | E | Write protect | Reserved | | | | | | | Write enable | | 0x00 |
| 0x0E01 | E | Condition | Reserved | | | | Conditional value, Bits[3:0] | | | | 0x00 | |
| 0x0E02 | A, E | Save | Reserved | | | | | | | Save to EEPROM | | 0x00 |
| 0x0E03 | A, E | Load | Reserved | | | | | | | Load from EEPROM | | 0x00 |
| EEPROM Storage Sequence | | | | | | | | | | | | |
| 0x0E10 | | User free run | Command: Set user free run mode | | | | | | | | | 0x98 |
| 0x0E11 | | User scratchpad | Size of transfer: two bytes | | | | | | | | | 0x01 |
| 0x0E12 | | | Starting Address 0x000E | | | | | | | | | 0x00 |
| 0x0E13 | | | | | | | | | | | | 0x0E |
| 0x0E14 | | M pins and IRQ masks | Size of transfer: 19 bytes | | | | | | | | | 0x12 |
| 0x0E15 | | | Starting Address 0x0100 | | | | | | | | | 0x01 |
| 0x0E16 | | | | | | | | | | | | 0x00 |
| 0x0E17 | | System clock | Size of transfer: eight bytes | | | | | | | | | 0x07 |
| 0x0E18 | | | Starting Address 0x0200 | | | | | | | | | 0x02 |
| 0x0E19 | | | | | | | | | | | | 0x00 |
| 0x0E1A | | IO_UPDATE | Command: IO_UPDATE | | | | | | | | | 0x80 |
| 0x0E1B | | REFA | Size of transfer: 27 bytes | | | | | | | | | 0x1A |
| 0x0E1C | | | Starting Address 0x0300 | | | | | | | | | 0x03 |
| 0x0E1D | | | | | | | | | | | | 0x00 |
| 0x0E1E | | REFB | Size of transfer: 27 bytes | | | | | | | | | 0x1A |
| 0x0E1F | | | Starting Address 0x0320 | | | | | | | | | 0x03 |
| 0x0E20 | | | | | | | | | | | | 0x20 |
| 0x0E21 | | REFC | Size of transfer: 27 bytes | | | | | | | | | 0x1A |
| 0x0E22 | | | Starting Address 0x0340 | | | | | | | | | 0x03 |
| 0x0E23 | | | | | | | | | | | | 0x40 |
| 0x0E24 | | REFD | Size of transfer: 27 bytes | | | | | | | | | 0x1A |
| 0x0E25 | | | Starting Address 0x0360 | | | | | | | | | 0x03 |
| 0x0E26 | | | | | | | | | | | | 0x60 |
| 0x0E27 | | DPLL_0 general settings | Size of transfer: 22 bytes | | | | | | | | | 0x15 |
| 0x0E28 | | | Starting Address 0x0400 | | | | | | | | | 0x04 |
| 0x0E29 | | | | | | | | | | | | 0x00 |
| 0x0E2A | | APLL_0 config and output drivers | Size of transfer: 15 bytes | | | | | | | | | 0x0E |
| 0x0E2B | | | Starting Address 0x0420 | | | | | | | | | 0x04 |
| 0x0E2C | | | | | | | | | | | | 0x20 |

| Reg Addr (Hex) | Opt | Name | D7 | D6 | D5 | D4 | D3 | D2 | D1 | D0 | Def (Hex) |
|------------------|-------------------------|----------------------------------|--|----|----|----|----|----|------|----|-----------|
| 0x0E2D | | DPLL_0 dividers and BW | Size of transfer: 52 bytes | | | | | | | | 0x33 |
| 0x0E2E | Starting Address 0x0440 | | | | | | | | 0x04 | | |
| 0x0E2F | | | | | | | | | 0x40 | | |
| 0x0E30 | | DPLL_1 general settings | Size of transfer: 22 bytes | | | | | | | | 0x15 |
| 0x0E31 | Starting Address 0x0500 | | | | | | | | 0x05 | | |
| 0x0E32 | | | | | | | | | 0x00 | | |
| 0x0E33 | | APLL_1 config and output drivers | Size of transfer: 15 bytes | | | | | | | | 0x0E |
| 0x0E34 | Starting Address 0x0520 | | | | | | | | 0x05 | | |
| 0x0E35 | | | | | | | | | 0x20 | | |
| 0x0E36 | | DPLL_1 dividers and BW | Size of transfer: 52 bytes | | | | | | | | 0x33 |
| 0x0E37 | Starting Address 0x0540 | | | | | | | | 0x05 | | |
| 0x0E38 | | | | | | | | | 0x40 | | |
| 0x0E39 | | Loop filter | Size of transfer: 24 bytes | | | | | | | | 0x17 |
| 0x0E3A | Starting Address 0x0800 | | | | | | | | 0x08 | | |
| 0x0E3B | | | | | | | | | 0x00 | | |
| 0x0E3C | | Common operational controls | Size of transfer: 15 bytes | | | | | | | | 0x0E |
| 0x0E3D | Starting Address 0x0A00 | | | | | | | | 0x0A | | |
| 0x0E3E | | | | | | | | | 0x00 | | |
| 0x0E3F | | PLL_0 operational controls | Size of transfer: five bytes | | | | | | | | 0x04 |
| 0x0E40 | Starting Address 0x0A20 | | | | | | | | 0x0A | | |
| 0x0E41 | | | | | | | | | 0x20 | | |
| 0x0E42 | | PLL_1 operational controls | Size of transfer: five bytes | | | | | | | | 0x04 |
| 0x0E43 | Starting Address 0x0A40 | | | | | | | | 0x0A | | |
| 0x0E44 | | | | | | | | | 0x40 | | |
| 0x0E45 | | IO_UPDATE | Command: IO_UPDATE | | | | | | | | 0x80 |
| 0x0E46 | | Calibrate APLLs | Command: calibrate output PLLs | | | | | | | | 0x90 |
| 0x0E47 | | Sync outputs | Command: distribution sync | | | | | | | | 0xA0 |
| 0x0E48 | | End of data | Command: end of data | | | | | | | | 0xFF |
| 0x0E49 to 0x0E4F | | Unused | Unused (available for additional data transfers and/or commands) | | | | | | | | 0x00 |

REGISTER MAP BIT DESCRIPTIONS

SERIAL CONTROL PORT CONFIGURATION (REGISTER 0x0000 TO REGISTER 0x0005)

Table 35. Serial Configuration (Note that the contents of Register 0x0000 are not stored to the EEPROM.)

| Address | Bits | Bit Name | Description |
|---------|-------|-----------------------------|--|
| 0x0000 | 7 | SDO enable | Enables SPI port SDO pin. 1 = 4-wire (SDO pin enabled). 0 (default) = 3-wire. |
| | 6 | LSB first/increment address | Bit order for SPI port. 1 = least significant bit and byte first. Register addresses are automatically incremented in multibyte transfers. 0 (default) = most significant bit and byte first. Register addresses are automatically decremented in multibyte transfers. |
| | 5 | Soft reset | Device reset (invokes an EEPROM download if EEPROM or pin program is enabled.) See the EEPROM and Pin Configuration and Function Descriptions sections for details. |
| | [4:0] | Reserved | Default: 0x00. |

Table 36. Readback Control

| Address | Bits | Bit Name | Description |
|---------|-------|----------------------|--|
| 0x0004 | [7:5] | Reserved | Default: 0x00. |
| | 4 | Reset sans reg map | Resets the part while maintaining the current register settings. 1 = resets the device. 0 (default) = no action. |
| | 3 | Disable auto actions | Disables the automatic updating of DPLL parameters. 1 = disables the automatic register write detection functions described in Table 32. 0 (default) = the live registers in the DPLL profile registers update immediately. |
| | 2 | Reserved | Default: 0x00. |
| | 1 | 2-wire SPI | Enables 2-wire SPI mode, in which the \overline{CS} pin state is ignored. Note that the \overline{CS} stalled high function is not available in this mode and that the correct number of clock edges must be present on the SCLK pin during a transfer. 1 = ignores the state of the \overline{CS} pin, making the M5/ \overline{CS} pin available as an M pin for control/status of the AD9559. 0 (default) = normal SPI operation. |
| | 0 | Read buffer register | For buffered registers, serial port readback reads from actual (active) registers instead of the buffer. 1 = reads buffered values that take effect on next assertion of IO_UPDATE. 0 (default) = reads values currently applied to the device's internal logic. |

Table 37. Soft IO_UPDATE

| Address | Bits | Bit Name | Description |
|---------|-------|-----------|--|
| 0x0005 | [7:1] | Reserved | Reserved. |
| | 0 | IO_UPDATE | Writing a 1 to this bit transfers the data in the serial I/O buffer registers to the device's internal control registers. This is an autoclearing bit. |

CLOCK PART FAMILY ID (REGISTER 0x000C AND REGISTER 0x000D)

Table 38. Clock Part Family ID

| Address | Bits | Bit Name | Description |
|---------|-------|----------------------------------|--|
| 0x000C | [7:0] | Clock part family ID, Bits[7:0] | The values in this read-only register and Register 0x000D uniquely identify the AD9559. This is useful in cases where the user's software must determine which device is located at a given I ² C address. Default: 0x02 for the AD9559. |
| 0x000D | [7:0] | Clock part family ID, Bits[15:8] | Default: 0x00 for the AD9559. |

USER SCRATCHPAD (REGISTER 0x000E AND REGISTER 0x000F)

Table 39. User Scratchpad

| Address | Bits | Bit Name | Description |
|---------|-------|-----------------------------|--|
| 0x000E | [7:0] | User scratchpad, Bits[7:0] | User programmable EEPROM ID registers. These registers enable users to write a unique code of their choosing to keep track of revisions to the EEPROM register loading. It has no effect on part operation. Default = 0x0000. |
| 0x000F | [7:0] | User scratchpad, Bits[15:8] | |

GENERAL CONFIGURATION (REGISTER 0x0100 TO REGISTER 0x0109)**Multifunction Pin Control (M0 to M5) and Watchdog Timer**

Table 40. Multifunction Pins (M0 to M5) Control

| Address | Bits | Bit Name | Description |
|---------|-------|---------------------------------|--|
| 0x0100 | [7:6] | M3 driver mode, Bits[1:0] | 00 (default) = active high CMOS. 01 = active low CMOS. 10 = open-drain PMOS (requires an external pull-down resistor). 11 = open-drain NMOS (requires an external pull-up resistor). |
| | [5:4] | M2 driver mode, Bits[1:0] | The settings of these bits are identical to Register 0x0100[7:6]. |
| | [3:2] | M1 driver mode, Bits[1:0] | The settings of these bits are identical to Register 0x0100[7:6]. |
| | [1:0] | M0 driver mode, Bits[1:0] | The settings of these bits are identical to Register 0x0100[7:6]. |
| 0x0101 | [7:4] | Reserved | Reserved. |
| | [3:2] | M5 driver mode, Bits[1:0] | The settings of these bits are identical to Register 0x0100[7:6]. Note that, for this pin to be an M pin, either I ² C or 2-wire SPI mode must be enabled. |
| | [1:0] | M4 driver mode, Bits[1:0] | The settings of these bits are identical to Register 0x0100[7:6]. Note that, for this pin to be an M pin, 4-wire SPI mode must be disabled. |
| 0x0102 | 7 | M0 output/input | Input/output control for M0 pin. 0 (default) = input (control pin) 1 = output (status pin) |
| | [6:0] | M0 function | These bits control the function of the M0 pin. See Table 196 and Table 197 for details about the input and output functions that are available. Default: 0x00 = high impedance control pin, no function assigned. |
| 0x0103 | 7 | M1 output/input | Input/output control for M1 pin (same as for the M0 pin). |
| | [6:0] | M1 function | These bits control the function of the M1 pin and are the same as Register 0x0102[6:0]. Default: 0x00 = high impedance control pin, no function assigned. |
| 0x0104 | 7 | M2 output/input | Input/output control for M2 pin (same as for the M0 pin). |
| | [6:0] | M2 function | These bits control the function of the M2 pin and are the same as Register 0x0102[6:0]. Default: 0x00 = high impedance control pin, no function assigned. |
| 0x0105 | 7 | M3 output/input | Input/output control for M3 pin (same as for the M0 pin). |
| | [6:0] | M3 function | These bits control the function of the M3 pin and are the same as Register 0x0102[6:0]. Default: 0x00 = high impedance control pin, no function assigned. |
| 0x0106 | 7 | M4 output/input | Input/output control for M3 pin (same as for the M0 pin). |
| | [6:0] | M4 function | These bits control the function of the M4 pin and are the same as Register 0x0102[6:0]. Default: 0x00 = high impedance control pin, no function assigned. |
| 0x0107 | 7 | M5 output/input | Input/output control for M3 pin (same as for the M0 pin). |
| | [6:0] | M5 function | These bits control the function of the M5 pin and are the same as Register 0x0102[6:0]. Default: 0x00 = high impedance control pin, no function assigned. |
| 0x0108 | [7:0] | Watchdog timer (in units of ms) | Watchdog timer, Bits[7:0]. The watchdog timer stops when this register is written, and restarts on the next IO_UPDATE (Register 0x0005 = 0x01). Default: 0x00 (0x0000 = disabled). |
| 0x0109 | [7:0] | | Watchdog timer, Bits[15:8]. The watchdog timer stops when this register is written, and restarts on the next IO_UPDATE (Register 0x0005 = 0x01). Default: 0x00. |

IRQ MASK (REGISTER 0x010A TO REGISTER 0x112)

The IRQ mask register bits form a one-to-one correspondence with the bits of the IRQ monitor register (0x0D08 to 0x0D10). When set to Logic 1, the IRQ mask bits enable the corresponding IRQ monitor bits to indicate an IRQ event. The default for all IRQ mask bits is Logic 0, which prevents the IRQ monitor from detecting any internal interrupts.

Table 41. IRQ Mask for SYSCLK, Watchdog Timer, and EEPROM

| Address | Bits | Bit Name | Description |
|---------|------|-----------------|---|
| 0x010A | 7 | Reserved | Reserved. |
| | 6 | SYSCLK unlocked | Enables IRQ for indicating a SYSCLK PLL state transition from locked to unlocked. |
| | 5 | SYSCLK stable | Enables IRQ for indicating that SYSCLK stability time has expired and that the SYSCLK PLL is considered to be stable. |
| | 4 | SYSCLK locked | Enables IRQ for indicating a SYSCLK PLL state transition from unlocked to locked. |
| | 3 | Watchdog timer | Enables IRQ for indicating expiration of the watchdog timer. |
| | 2 | Reserved | Reserved. |
| | 1 | EEPROM fault | Enables IRQ for indicating a fault during an EEPROM load or save operation. |
| | 0 | EEPROM complete | Enables IRQ for indicating successful completion of an EEPROM load or save operation. |

Table 42. IRQ Mask for Reference Inputs

| Address | Bits | Bit Name | Description |
|---------|------|--------------------|--|
| 0x010B | 7 | Reserved | Reserved. |
| | 6 | REFB validated | Enables IRQ for indicating that REFB has been validated. |
| | 5 | REFB fault cleared | Enables IRQ for indicating that REFB has been cleared of a previous fault. |
| | 4 | REFB fault | Enables IRQ for indicating that REFB has been faulted. |
| | 3 | Reserved | Reserved. |
| | 2 | REFA validated | Enables IRQ for indicating that REFA has been validated. |
| | 1 | REFA fault cleared | Enables IRQ for indicating that REFA has been cleared of a previous fault. |
| | 0 | REFA fault | Enables IRQ for indicating that REFA has been faulted. |
| 0x010C | 7 | Reserved | Reserved. |
| | 6 | REFD validated | Enables IRQ for indicating that REFD has been validated. |
| | 5 | REFD fault cleared | Enables IRQ for indicating that REFD has been cleared of a previous fault. |
| | 4 | REFD fault | Enables IRQ for indicating that REFD has been faulted. |
| | 3 | Reserved | Reserved. |
| | 2 | REFC validated | Enables IRQ for indicating that REFC has been validated. |
| | 1 | REFC fault cleared | Enables IRQ for indicating that REFC has been cleared of a previous fault. |
| | 0 | REFC fault | Enables IRQ for indicating that REFC has been faulted. |

Table 43. IRQ Mask for the Digital PLL0 (DPLL_0)

| Address | Bits | Bit Name | Description |
|---------|-------|-------------------------|--|
| 0x010D | 7 | Frequency unclamped | Enables IRQ to indicate that DPLL_0 has exited a frequency clamped state |
| | 6 | Frequency clamped | Enables IRQ to indicate that DPLL_0 has entered a frequency clamped state |
| | 5 | Phase slew unlimited | Enables IRQ to indicate that DPLL_0 has exited a phase slew limited state |
| | 4 | Phase slew limited | Enables IRQ to indicate that DPLL_0 has entered a phase slew limited state |
| | 3 | Frequency unlocked | Enables IRQ to indicate that DPLL_0 has lost frequency lock |
| | 2 | Frequency locked | Enables IRQ to indicate that DPLL_0 has acquired frequency lock |
| | 1 | Phase unlocked | Enables IRQ to indicate that DPLL_0 has lost phase lock |
| | 0 | Phase locked | Enables IRQ to indicate that DPLL_0 has acquired phase lock |
| 0x010E | 7 | Switching | Enables IRQ to indicate that DPLL_0 is switching to a new reference |
| | 6 | Free run | Enables IRQ to indicate that DPLL_0 has entered free run mode |
| | 5 | Holdover | Enables IRQ to indicate that DPLL_0 has entered holdover mode |
| | 4 | History updated | Enables IRQ to indicate that DPLL_0 has updated its tuning word history |
| | 3 | REFD activated | Enables IRQ to indicate that DPLL_0 has activated REFD |
| | 2 | REFC activated | Enables IRQ to indicate that DPLL_0 has activated REFC |
| | 1 | REFB activated | Enables IRQ to indicate that DPLL_0 has activated REFB |
| | 0 | REFA activated | Enables IRQ to indicate that DPLL_0 has activated REFA |
| 0x010F | [7:5] | Reserved | Reserved |
| | 4 | Sync clock distribution | Enables IRQ for indicating a distribution sync event |
| | 3 | APLL_0 unlocked | Enables IRQ for APLL_0 unlocked |
| | 2 | APLL_0 locked | Enables IRQ for APLL_0 locked |
| | 0 | APLL_0 cal started | Enables IRQ for APLL_0 calibration started |

Table 44. IRQ Mask for the Digital PLL1 (DPLL_1)

| Address | Bits | Bit Name | Description |
|---------|-------|-------------------------|--|
| 0x0110 | 7 | Frequency unclamped | Enables IRQ to indicate that DPLL_1 has exited a frequency clamped state |
| | 6 | Frequency clamped | Enables IRQ to indicate that DPLL_1 has entered a frequency clamped state |
| | 5 | Phase slew unlimited | Enables IRQ to indicate that DPLL_1 has exited a phase slew limited state |
| | 4 | Phase slew limited | Enables IRQ to indicate that DPLL_1 has entered a phase slew limited state |
| | 3 | Frequency unlocked | Enables IRQ to indicate that DPLL_1 has lost frequency lock |
| | 2 | Frequency locked | Enables IRQ to indicate that DPLL_1 has acquired frequency lock |
| | 1 | Phase unlocked | Enables IRQ to indicate that DPLL_1 has lost phase lock |
| | 0 | Phase locked | Enables IRQ to indicate that DPLL_1 has acquired phase lock |
| 0x0111 | 7 | Switching | Enables IRQ to indicate that DPLL_1 is switching to a new reference |
| | 6 | Free run | Enables IRQ to indicate that DPLL_1 has entered free run mode |
| | 5 | Holdover | Enables IRQ to indicate that DPLL_1 has entered holdover mode |
| | 4 | History updated | Enables IRQ to indicate that DPLL_1 has updated its tuning word history |
| | 3 | REFD activated | Enables IRQ to indicate that DPLL_1 has activated REFD |
| | 2 | REFC activated | Enables IRQ to indicate that DPLL_1 has activated REFC |
| | 1 | REFB activated | Enables IRQ to indicate that DPLL_1 has activated REFB |
| | 0 | REFA activated | Enables IRQ to indicate that DPLL_1 has activated REFA |
| 0x0112 | [7:5] | Reserved | Reserved |
| | 4 | Sync clock distribution | Enables IRQ for indicating a distribution sync event |
| | 3 | APLL_1 unlocked | Enables IRQ for APLL_1 unlocked |
| | 2 | APLL_1 locked | Enables IRQ for APLL_1 locked |
| | 0 | APLL_1 cal started | Enables IRQ for APLL_1 calibration started |

SYSTEM CLOCK (REGISTER 0x0200 TO REGISTER 0x0207)**Table 45. System Clock PLL Feedback Divider (K Divider) and Configuration**

| Address | Bits | Bit Name | Description |
|---------|-------|------------------------|--|
| 0x0200 | [7:0] | System clock K divider | System clock PLL feedback divider value = $4 \leq K \leq 255$ (default: 0x08). |

Table 46. SYSCLK Configuration

| Address | Bits | Bit Name | Description |
|---------|-------|------------------------------------|--|
| 0x0201 | [7:4] | Reserved | Reserved. |
| | 4 | SYSCLK XTAL enable | Enables the crystal maintaining amplifier for the system clock input. 1 (default) = crystal mode (crystal maintaining amplifier enabled). 0 = external crystal oscillator or other system clock source. |
| | [2:1] | SYSCLK J1 divider | System clock input divider. 00 (default) = 1. 01 = 2. 10 = 4. 11 = 8. |
| | 0 | SYSCLK doubler enable (J0 divider) | Enables the clock doubler on system clock input to reduce noise. Setting this bit may prevent the SYSCLK PLL from locking if the input duty cycle is not close enough to 50%. See Table 4 for the limits on duty cycle. 0 = disable. 1 (default) = enable. |

Table 47. Nominal System Clock Period

| Address | Bits | Bit Name | Description |
|---------|-------|----------------------------------|--|
| 0x0202 | [7:0] | Nominal system clock period (fs) | System clock period, Bits[7:0]. This is the period of the system clock. Default: 0x0E. [The default of 0x13670E = 1.271566 ns = $16 \times (1/49.152 \text{ MHz})$.] |
| 0x0203 | [7:0] | | System clock period, Bits[15:8]. Default: 0x67. |
| 0x0204 | [7:5] | Reserved | Default: 0x13. |
| | [4:0] | Nominal system clock period (fs) | System clock period, Bits[20:16]. Default: 0x13. |

Table 48. System Clock Stability Period

| Address | Bits | Bit Name | Description |
|---------|-------|------------------------------------|--|
| 0x0205 | [7:0] | System clock stability period (ms) | System clock period, Bits[7:0]. The system clock stability period is the amount of time that the system clock PLL must be locked before it is declared stable. The system clock stability timer is reset automatically if the user writes to this register. The system clock stability timer restarts on the next IO_UPDATE (Register 0x0005 = 0x01). Default: 0x32 (0x000032 = 50 ms). |
| 0x0206 | [7:0] | | System clock period, Bits[15:8]. The system clock stability timer is reset automatically if the user writes to this register. The system clock stability timer restarts on the next IO_UPDATE (Register 0x0005 = 0x01). Default: 0x00. |
| 0x0207 | [7:5] | Reserved | Default: 0x0. |
| | [3:0] | System clock stability period | System clock period, Bits[19:16]. The system clock stability timer is reset automatically if the user writes to this register. The system clock stability timer restarts on the next IO_UPDATE (Register 0x0005 = 0x01). Default: 0x0. |

REFERENCE INPUT A (REGISTER 0x0300 TO REGISTER 0x031A)**Table 49. REFA Logic Type**

| Address | Bits | Bit Name | Description |
|---------|-------|-------------------------|---|
| 0x0300 | [7:4] | Reserved | Default: 0x0 |
| | 3 | Enable REFA divide-by-2 | Enables the reference input divide-by-2 for REFA 0 = bypasses the divide-by-2 (default) 1 = enables the divide-by-2 |
| | 2 | Reserved | Default: 0b |
| | [1:0] | REFA logic type | Selects logic family for REFA input receiver; only the REFA pin is used in CMOS mode 00 (default) = differential 01 = 1.2 V to 1.5 V CMOS 10 = 1.8 V to 2.5 V CMOS 11 = 3.0 V to 3.3 V CMOS |

Table 50. REFA 20-Bit DPLL R Divider

| Address | Bits | Bit Name | Description |
|---------|-------|-----------|--|
| 0x0301 | [7:0] | R divider | DPLL integer reference divider (minus 1), Bits[7:0] (default: 0xCF) |
| 0x0302 | [7:0] | | DPLL integer reference divider (minus 1), Bits[15:8] (default: 0x00) |
| 0x0303 | [7:4] | Reserved | Default: 0x0 |
| | [3:0] | R divider | DPLL integer reference divider (minus 1), Bits[19:16] (default: 0x0) |

Table 51. Nominal Period of REFA Input Clock

| Address | Bits | Bit Name | Description |
|---------|-------|------------------------------------|---|
| 0x0304 | [7:0] | REFA nominal reference period (fs) | Nominal reference period, Bits[7:0] (default: 0xC9) |
| 0x0305 | [7:0] | | Nominal reference period, Bits[15:8] (default: 0xEA) |
| 0x0306 | [7:0] | | Nominal reference period, Bits[23:16] (default: 0x10) |
| 0x0307 | [7:0] | | Nominal reference period, Bits[31:24] (default: 0x03) |
| 0x0308 | [7:0] | | Nominal reference period, Bits[39:32] (default: 0x00) Default for Register 0x0304 to Register 0x0308: 0x000310EAC9 = 51.44 ns (1/19.44 MHz). |

Table 52. REFA Frequency Tolerance

| Address | Bits | Bit Name | Description |
|---------|-------|-----------------|---|
| 0x0309 | [7:0] | Inner tolerance | Input reference frequency monitor inner tolerance, Bits[7:0] (default: 0x14). |
| 0x030A | [7:0] | | Input reference frequency monitor inner tolerance, Bits[15:8] (default: 0x00). |
| 0x030B | [7:4] | Reserved | Default: 0x0. |
| | [3:0] | Inner tolerance | Input reference frequency monitor inner tolerance, Bits[19:16]. Default for Register 0x0309 to Register 0x30B: 0x000014 = 20 (5% or 50,000 ppm). The Stratum 3 clock requires inner tolerance of ± 9.2 ppm and outer tolerance of ± 12 ppm; an SMC clock requires outer tolerance of ± 48 ppm. The allowable range for the inner tolerance is 0x00A (10%) to 0x8FF (2 ppm). |
| 0x030C | [7:0] | Outer tolerance | Input reference frequency monitor outer tolerance, Bits[7:0] (default: 0x0A). |
| 0x030D | [7:0] | | Input reference frequency monitor outer tolerance, Bits[15:8] (default: 0x00). |
| 0x030E | [7:4] | Reserved | Default: 0x0. |
| | [3:0] | Outer tolerance | Input reference frequency monitor outer tolerance, Bits[19:16]. Default for Register 0x030C to Register 0x30E = 0x00000A = 10 (10% or 100,000 ppm). The Stratum 3 clock requires inner tolerance of ± 9.2 ppm and outer tolerance of ± 12 ppm; an SMC clock requires outer tolerance of ± 48 ppm. The outer tolerance must be greater than the inner tolerance so that there is hysteresis. |

Table 53. REFA Validation Timer

| Address | Bits | Bit Name | Description |
|---------|-------|-----------------------|---|
| 0x030F | [7:0] | Validation timer (ms) | Validation timer, Bits[7:0] (default: 0x0A). This is the amount of time a reference input must be valid before it is declared valid by the reference input monitor (default: 10 ms). |
| 0x0310 | [7:0] | | Validation timer, Bits[15:8] (default: 0x00). |

Table 54. REFA Lock Detectors

| Address | Bits | Bit Name | Description |
|---------|-------|---------------------------|---|
| 0x0311 | [7:0] | Phase lock threshold | Phase lock threshold, Bits[7:0] (default: 0xBC); default of 0x02BC = 700 ps |
| 0x0312 | [7:0] | | Phase lock threshold, Bits[15:8] (default: 0x02) |
| 0x0313 | [7:0] | | Phase lock threshold, Bits[23:16] (default: 0x00) |
| 0x0314 | [7:0] | Phase lock fill rate | Phase lock fill rate, Bits[7:0] (default: 0x0A = 10 code/PFD cycle) |
| 0x0315 | [7:0] | Phase lock drain rate | Phase lock drain rate, Bits[7:0] (default: 0x0A = 10 code/PFD cycle) |
| 0x0316 | [7:0] | Frequency lock threshold | Frequency lock threshold, Bits[7:0] (default: 0xBC); default of 0x02BC = 700 ps |
| 0x0317 | [7:0] | | Frequency lock threshold, Bits[15:8] (default: 0x02) |
| 0x0318 | [7:0] | | Frequency lock threshold, Bits[23:16] (default: 0x00) |
| 0x0319 | [7:0] | Frequency lock fill rate | Frequency lock fill rate, Bits[7:0] (default: 0x0A = 10 code/PFD cycle) |
| 0x031A | [7:0] | Frequency lock drain rate | Frequency lock drain rate, Bits[7:0] (default: 0x0A = 10 code/PFD cycle) |

REFERENCE INPUT B (REGISTER 0x0320 TO REGISTER 0x033A)

Table 55. REFB Logic Type

| Address | Bits | Bit Name | Description |
|---------|-------|-------------------------|---|
| 0x0320 | [7:4] | Reserved | Default: 0x0 |
| | 3 | Enable REFB divide-by-2 | Enables the reference input divide-by-2 for REFB 0 = bypasses the divide-by-2 (default) 1 = enables the divide-by-2 |
| | 2 | Reserved | Default: 0b |
| | [1:0] | REFB logic type | Selects logic family for REFB input receiver; only the REFB pin is used in CMOS mode 00 (default) = differential 01 = 1.2 V to 1.5 V CMOS 10 = 1.8 V to 2.5 V CMOS 11 = 3.0 V to 3.3 V CMOS |

Table 56. REFB 20-Bit DPLL R Divider

| Address | Bits | Bit Name | Description |
|---------|-------|-----------|--|
| 0x0321 | [7:0] | R divider | DPLL integer reference divider (minus 1), Bits[7:0] (default: 0xCF) |
| 0x0322 | [7:0] | | DPLL integer reference divider (minus 1), Bits[15:8] (default: 0x00) |
| 0x0323 | [7:4] | Reserved | Default: 0x0 |
| | [3:0] | R divider | DPLL integer reference divider (minus 1), Bits[19:16] (default: 0x0) |

Table 57. Nominal Period of REFB Input Clock

| Address | Bits | Bit Name | Description |
|---------|-------|------------------------------------|--|
| 0x0324 | [7:0] | REFB nominal reference period (fs) | Nominal reference period, Bits[7:0] (default: 0xC9). |
| 0x0325 | [7:0] | | Nominal reference period, Bits[15:8] (default: 0xEA). |
| 0x0326 | [7:0] | | Nominal reference period, Bits[23:16] (default: 0x10). |
| 0x0327 | [7:0] | | Nominal reference period, Bits[31:24] (default: 0x03). |
| 0x0328 | [7:0] | | Nominal reference period, Bits[39:32] (default: 0x00). Default for Register 0x0324 to Register 0x0328: 0x000310EAC9 = 51.44 ns (1/19.44 MHz). |

Table 58. REFB Frequency Tolerance

| Address | Bits | Bit Name | Description |
|---------|-------|-----------------|---|
| 0x0329 | [7:0] | Inner tolerance | Input reference frequency monitor inner tolerance, Bits[7:0] (default: 0x14) |
| 0x032A | [7:0] | | Input reference frequency monitor inner tolerance, Bits[15:8] (default: 0x00) |
| 0x032B | [7:4] | Reserved | Default: 0x0 |
| | [3:0] | Inner tolerance | Input reference frequency monitor inner tolerance, Bits[19:16]. Default for Register 0x0329 to Register 0x032B: 0x000014 = 20 (5% or 50,000 ppm). The Stratum 3 clock requires inner tolerance of ± 9.2 ppm and outer tolerance of ± 12 ppm; an SMC clock requires outer tolerance of ± 48 ppm. The allowable range for the inner tolerance is 0x00A (10%) to 0x8FF (2 ppm). |
| 0x032C | [7:0] | Outer tolerance | Input reference frequency monitor outer tolerance, Bits[7:0] (default: 0x0A). |
| 0x032D | [7:0] | | Input reference frequency monitor outer tolerance, Bits[15:8] (default: 0x00). |
| 0x032E | [7:4] | Reserved | Default: 0x0 |
| | [3:0] | Outer tolerance | Input reference frequency monitor outer tolerance, Bits[19:16]. Default for Register 0x032C to Register 0x032E: 0x00000A = 10 (10% or 100,000 ppm). The Stratum 3 clock requires inner tolerance of ± 9.2 ppm and outer tolerance of ± 12 ppm; an SMC clock requires outer tolerance of ± 48 ppm. The outer tolerance must be greater than the inner tolerance so that there is hysteresis. |

Table 59. REFB Validation Timer

| Address | Bits | Bit Name | Description |
|---------|-------|-----------------------|--|
| 0x032F | [7:0] | Validation timer (ms) | Validation timer, Bits[7:0] (default: 0x0A). This is the amount of time a reference input must be valid before it is declared valid by the reference input monitor (default: 10 ms). |
| 0x0330 | [7:0] | | Validation timer, Bits[15:8] (default: 0x00). |

Table 60. REFB Lock Detectors

| Address | Bits | Bit Name | Description |
|---------|-------|---------------------------|---|
| 0x0331 | [7:0] | Phase lock threshold | Phase lock threshold, Bits[7:0] (default: 0xBC); default of 0x02BC = 700 ps |
| 0x0332 | [7:0] | | Phase lock threshold, Bits[15:8] (default: 0x02) |
| 0x0333 | [7:0] | | Phase lock threshold, Bits[23:16] (default: 0x00) |
| 0x0334 | [7:0] | Phase lock fill rate | Phase lock fill rate, Bits[7:0] (default: 0x0A = 10 code/PFD cycle) |
| 0x0335 | [7:0] | Phase lock drain rate | Phase lock drain rate, Bits[7:0] (default: 0x0A = 10 code/PFD cycle) |
| 0x0336 | [7:0] | Frequency lock threshold | Frequency lock threshold, Bits[7:0] (default: 0xBC); default of 0x02BC = 700 ps |
| 0x0337 | [7:0] | | Frequency lock threshold, Bits[15:8] (default: 0x02) |
| 0x0338 | [7:0] | | Frequency lock threshold, Bits[23:16] (default: 0x00) |
| 0x0339 | [7:0] | Frequency lock fill rate | Frequency lock fill rate, Bits[7:0] (default: 0x0A = 10 code/PFD cycle) |
| 0x033A | [7:0] | Frequency lock drain rate | Frequency lock drain rate, Bits[7:0] (default: 0x0A = 10 code/PFD cycle) |

REFERENCE INPUT C (REGISTER 0x0340 TO REGISTER 0x035A)

Table 61. REFC Logic Type

| Address | Bits | Bit Name | Description |
|---------|-------|-------------------------|---|
| 0x0340 | [7:4] | Reserved | Default: 0x0 |
| | 3 | Enable REFC divide-by-2 | Enables the reference input divide-by-2 for REFC 0 = bypasses the divide-by-2 (default) 1 = enables the divide-by-2 |
| | 2 | Reserved | Default: 0b |
| | [1:0] | REFC logic type | Selects logic family for REFC input receiver; only the REFC pin is used in CMOS mode 00 (default) = differential 01 = 1.2 V to 1.5 V CMOS 10 = 1.8 V to 2.5 V CMOS 11 = 3.0 V to 3.3 V CMOS |

Table 62. REFC 20-bit DPLL R Divider

| Address | Bits | Bit Name | Description |
|---------|-------|-----------|--|
| 0x0341 | [7:0] | R divider | DPLL integer reference divider (minus 1), Bits[7:0] (default: 0xCF) |
| 0x0342 | [7:0] | | DPLL integer reference divider (minus 1), Bits[15:8] (default: 0x00) |
| 0x0343 | [7:4] | Reserved | Default: 0x0 |
| | [3:0] | R divider | DPLL integer reference divider (minus 1), Bits[19:16] (default: 0x0) |

Table 63. Nominal Period of REFC Input Clock

| Address | Bits | Bit Name | Description |
|---------|-------|------------------------------------|--|
| 0x0344 | [7:0] | REFC nominal reference period (fs) | Nominal reference period, Bits[7:0] (default: 0xC9) |
| 0x0345 | [7:0] | | Nominal reference period, Bits[15:8] (default: 0xEA) |
| 0x0346 | [7:0] | | Nominal reference period, Bits[23:16] (default: 0x10) |
| 0x0347 | [7:0] | | Nominal reference period, Bits[31:24] (default: 0x03) |
| 0x0348 | [7:0] | | Nominal reference period, Bits[39:32] (default: 0x00) Default for Register 0x0344 to Register 0x0348: 0x000310EAC9 = 51.44 ns (1/19.44 MHz) |

Table 64. REFC Frequency Tolerance

| Address | Bits | Bit Name | Description |
|---------|-------|-----------------|---|
| 0x0349 | [7:0] | Inner tolerance | Input reference frequency monitor inner tolerance, Bits[7:0] (default: 0x14). |
| 0x034A | [7:0] | | Input reference frequency monitor inner tolerance, Bits[15:8] (default: 0x00). |
| 0x034B | [7:4] | Reserved | Default: 0x0. |
| | [3:0] | Inner tolerance | Input reference frequency monitor inner tolerance, Bits[19:16]. Default for Register 0x0349 to Register 0x034B: 0x000014 = 20 (5% or 50,000 ppm). The Stratum 3 clock requires inner tolerance of ± 9.2 ppm and outer tolerance of ± 12 ppm; an SMC clock requires outer tolerance of ± 48 ppm. The allowable range for the inner tolerance is 0x00A (10%) to 0x8FF (2 ppm). |
| 0x034C | [7:0] | Outer tolerance | Input reference frequency monitor outer tolerance, Bits [7:0] (default: 0x0A). |
| 0x034D | [7:0] | | Input reference frequency monitor outer tolerance, Bits[15:8] (default: 0x00). |
| 0x034E | [7:4] | Reserved | Default: 0x0. |
| | [3:0] | Outer tolerance | Input reference frequency monitor outer tolerance, Bits[19:16]. Default for Register 0x034C to Register 0x034E: 0x00000A = 10 (10% or 100,000 ppm). The Stratum 3 clock requires inner tolerance of ± 9.2 ppm and outer tolerance of ± 12 ppm; an SMC clock requires outer tolerance of ± 48 ppm. The outer tolerance must be greater than the inner tolerance so that there is hysteresis. |

Table 65. REFC Validation Timer

| Address | Bits | Bit Name | Description |
|---------|-------|-----------------------|---|
| 0x034F | [7:0] | Validation timer (ms) | Validation timer, Bits[7:0] (default: 0x0A). This is the amount of time a reference input must be valid before it is declared valid by the reference input monitor (default: 10 ms). |
| 0x0350 | [7:0] | | Validation timer, Bits[15:8] (default: 0x00). |

Table 66. REFC Lock Detectors

| Address | Bits | Bit Name | Description |
|---------|-------|---------------------------|---|
| 0x0351 | [7:0] | Phase lock threshold | Phase lock threshold, Bits[7:0] (default: 0xBC); default of 0x02BC = 700 ps |
| 0x0352 | [7:0] | | Phase lock threshold, Bits[15:8] (default: 0x02) |
| 0x0353 | [7:0] | | Phase lock threshold, Bits[23:16] (default: 0x00) |
| 0x0354 | [7:0] | Phase lock fill rate | Phase lock fill rate, Bits[7:0] (default: 0x0A = 10 code/PFD cycle) |
| 0x0355 | [7:0] | Phase lock drain rate | Phase lock drain rate, Bits[7:0] (default: 0x0A = 10 code/PFD cycle) |
| 0x0356 | [7:0] | Frequency lock threshold | Frequency lock threshold, Bits[7:0] (default: 0xBC); default of 0x02BC = 700 ps |
| 0x0357 | [7:0] | | Frequency lock threshold, Bits[15:8] (default: 0x02) |
| 0x0358 | [7:0] | | Frequency lock threshold, Bits[23:16] (default: 0x00) |
| 0x0359 | [7:0] | Frequency lock fill rate | Frequency lock fill rate, Bits[7:0] (default: 0x0A = 10 code/PFD cycle) |
| 0x035A | [7:0] | Frequency lock drain rate | Frequency lock drain rate, Bits[7:0] (default: 0x0A = 10 code/PFD cycle) |

REFERENCE INPUT D (REGISTER 0x0360 TO REGISTER 0x037A)**Table 67. REFD Logic Type**

| Address | Bits | Bit Name | Description |
|---------|-------|-------------------------|---|
| 0x0360 | [7:4] | Reserved | Default: 0x0 |
| | 3 | Enable REFD divide-by-2 | Enables the reference input divide-by-2 for REFD 0 = bypasses the divide-by-2 (default) 1 = enables the divide-by-2 |
| | 2 | Reserved | Default: 0b |
| | [1:0] | REFD logic type | Selects logic family for REFD input receiver; only the REFD pin is used in CMOS mode 00 (default) = differential 01 = 1.2 V to 1.5 V CMOS 10 = 1.8 V to 2.5 V CMOS 11 = 3.0 V to 3.3 V CMOS |

Table 68. REFD 20-Bit DPLL R Divider

| Address | Bits | Bit Name | Description |
|---------|-------|-----------|--|
| 0x0361 | [7:0] | R divider | DPLL integer reference divider (minus 1), Bits[7:0] (default: 0xCF) |
| 0x0362 | [7:0] | | DPLL integer reference divider (minus 1), Bits[15:8] (default: 0x00) |
| 0x0363 | [7:4] | Reserved | Default: 0x0 |
| | [3:0] | R divider | DPLL integer reference divider (minus 1), Bits[19:16] (default: 0x0) |

Table 69. Nominal Period of REFD Input Clock

| Address | Bits | Bit Name | Description |
|---------|-------|------------------------------------|---|
| 0x0364 | [7:0] | REFD nominal reference period (fs) | Nominal reference period, Bits[7:0] (default: 0xC9) |
| 0x0365 | [7:0] | | Nominal reference period, Bits[15:8] (default: 0xEA) |
| 0x0366 | [7:0] | | Nominal reference period, Bits[23:16] (default: 0x10) |
| 0x0367 | [7:0] | | Nominal reference period, Bits[31:24] (default: 0x03) |
| 0x0368 | [7:0] | | Nominal reference period Bits[39:32] (default: 0x00) Default for Register 0x0364 to Register 0x0368: 0x000310EAC9 = 51.44 ns (1/19.44 MHz) |

Table 70. REFD Frequency Tolerance

| Address | Bits | Bit Name | Description |
|---------|-------|-----------------|---|
| 0x0369 | [7:0] | Inner tolerance | Input reference frequency monitor inner tolerance, Bits[7:0] (default: 0x14). |
| 0x036A | [7:0] | | Input reference frequency monitor inner tolerance, Bits[15:8] (default: 0x00). |
| 0x036B | [7:4] | Reserved | Default: 0x0. |
| | [3:0] | Inner tolerance | Input reference frequency monitor inner tolerance, Bits[19:16]. Default for Register 0x0369 to Register 0x036B: 0x000014 = 20 (5% or 50,000 ppm). The Stratum 3 clock requires inner tolerance of ± 9.2 ppm and outer tolerance of ± 12 ppm; an SMC clock requires an outer tolerance of ± 48 ppm. The allowable range for the inner tolerance is 0x00A (10%) to 0x8FF (2 ppm). |
| 0x036C | [7:0] | Outer tolerance | Input reference frequency monitor outer tolerance, Bits [7:0] (default: 0x0A). |
| 0x036D | [7:0] | | Input reference frequency monitor outer tolerance, Bits[15:8] (default: 0x00). |
| 0x036E | [7:4] | Reserved | Default: 0x0. |
| | [3:0] | Outer tolerance | Input reference frequency monitor outer tolerance, Bits[19:16]. Default for Register 0x036C to Register 0x036E: 0x00000A = 10 (10% or 100,000 ppm). The Stratum 3 clock requires an inner tolerance of ± 9.2 ppm and outer tolerance of ± 12 ppm; an SMC clock requires outer tolerance of ± 48 ppm. The outer tolerance must be greater than the inner tolerance so that there is hysteresis. |

Table 71. REFD Validation Timer

| Address | Bits | Bit Name | Description |
|---------|-------|-----------------------|---|
| 0x036F | [7:0] | Validation timer (ms) | Validation timer, Bits[7:0] (default: 0x0A). This is the amount of time a reference input must be valid before it is declared valid by the reference input monitor (default: 10 ms). |
| 0x0370 | [7:0] | | Validation timer, Bits[15:8] (default: 0x00). |

Table 72. REFD Lock Detectors

| Address | Bits | Bit Name | Description |
|---------|-------|---------------------------|---|
| 0x0371 | [7:0] | Phase lock threshold | Phase lock threshold, Bits[7:0] (default: 0xBC); default of 0x02BC = 700 ps |
| 0x0372 | [7:0] | | Phase lock threshold, Bits[15:8] (default: 0x02) |
| 0x0373 | [7:0] | | Phase lock threshold, Bits[23:16] (default: 0x00) |
| 0x0374 | [7:0] | Phase lock fill rate | Phase lock fill rate, Bits[7:0] (default: 0x0A = 10 code/PFD cycle) |
| 0x0375 | [7:0] | Phase lock drain rate | Phase lock drain rate, Bits[7:0] (default: 0x0A=10 code/PFD cycle) |
| 0x0376 | [7:0] | Frequency lock threshold | Frequency lock threshold, Bits[7:0] (default: 0xBC); default of 0x02BC = 700 ps |
| 0x0377 | [7:0] | | Frequency lock threshold, Bits[15:8] (default: 0x02) |
| 0x0378 | [7:0] | | Frequency lock threshold, Bits[23:16] (default: 0x00) |
| 0x0379 | [7:0] | Frequency lock fill rate | Frequency lock fill rate, Bits[7:0] (default: 0x0A = 10 code/PFD cycle) |
| 0x037A | [7:0] | Frequency lock drain rate | Frequency lock drain rate, Bits[7:0] (default: 0x0A = 10 code/PFD cycle) |

DPLL_0 CONTROLS (REGISTER 0x0400 TO REGISTER 0x0415)

Table 73. DPLL_0 Free Run Frequency Tuning Word

| Address | Bits | Bit Name | Description |
|---------|-------|---|--|
| 0x0400 | [7:0] | 30-bit free running frequency tuning word | Free running frequency tuning word, Bits[7:0]; default: 0x12 |
| 0x0401 | [7:0] | | Free running frequency tuning word, Bits[15:8]; default: 0x15 |
| 0x0402 | [7:0] | | Free running frequency tuning word, Bits[23:16]; default: 0x64 |
| 0x0403 | [7:6] | Reserved | Default: 00b |
| | [5:0] | 30-bit free running frequency tuning word | Free running frequency tuning word, Bits[29:24]; default: 0x1B |

Table 74. DPLL_0 Digital Oscillator Control

| Address | Bits | Bit Name | Description |
|---------|-------|-------------------------------------|--|
| 0x0404 | [7:5] | Reserved | Default: 0x0 |
| | [4:0] | Digital oscillator SDM integer part | 0000 to 0011 = invalid 0100 = divide-by-4 0101 = invalid 0110 = divide-by-6 0111 = divide-by-7 1000 = divide-by-8 (default) 1001 = divide-by-9 1010 = divide-by-10 1011 = divide-by-11 1100 = divide-by-12 1101 = divide-by-13 1110 = divide-by-14 1111 = divide-by-15 |

Table 75. DPLL_0 Frequency Clamp

| Address | Bits | Bit Name | Description |
|---------|-------|--|--|
| 0x0405 | [7:0] | Lower limit of pull-in range (expressed as a 20-bit frequency tuning word) | Lower limit pull-in range, Bits[7:0] Default: 0x51 |
| 0x0406 | [7:0] | | Lower limit pull-in range, Bits[15:8] Default: 0xB8 |
| 0x0407 | [7:4] | Reserved | Default: 0x0 |
| | [3:0] | Lower limit of pull-in range | Lower limit pull-in range, Bits[19:16] Default: 0x2 |
| 0x0408 | [7:0] | Upper limit of pull-in range (expressed as a 20-bit frequency tuning word) | Upper limit pull-in range, Bits[7:0] Default: 0x3E |
| 0x0409 | [7:0] | | Upper limit pull-in range, Bits[15:8] Default: 0x0A |
| 0x040A | [7:4] | Reserved | Default: 0x0 |
| | [3:0] | Upper limit of pull-in range | Upper limit pull-in range, Bits[19:16] Default: 0xB |

Table 76. DPLL_0 History Accumulation Timer

| Address | Bits | Bit Name | Description |
|---------|-------|---|---|
| 0x040B | [7:0] | History accumulation timer (expressed in units of ms) | History accumulation timer, Bits[7:0]. Default: 0x0A. For Register 0x040B and Register 0x040C, 0x000A = 10 ms. Maximum: 65 sec. This register controls the amount of tuning word averaging used to determine the tuning word used in holdover. Never program a timer value of 0. Default value: 0x000A = 10 (10 ms). |
| 0x040C | [7:0] | | History accumulation timer, Bits[15:8]. Default: 0x00. |

Table 77. DPLL_0 History Mode

| Address | Bits | Bit Name | Description |
|---------|-------|------------------------|--|
| 0x040D | [7:5] | Reserved | Reserved. |
| | 4 | Single sample fallback | Controls holdover history. If tuning word history is not available for the reference that was active just prior to holdover, then: 0 (default) = uses the free running frequency tuning word register value. 1 = uses the last tuning word from the DPLL. |
| | 3 | Persistent history | Controls holdover history initialization. When switching to a new reference: 0 (default) = clears the tuning word history. 1 = retains the previous tuning word history. |
| | [2:0] | Incremental average | History mode value from 0 to 7 (default: 0). When set to nonzero, causes the first history accumulation to update prior to the first complete averaging period. After the first full interval, updates occur only at the full period. 0 (default) = update only after the full interval has elapsed. 1 = update at 1/2 the full interval. 2 = update at 1/4 and 1/2 of the full interval. 3 = update at 1/8, 1/4, and 1/2 of the full interval. ... 7 = update at 1/256, 1/128, 1/64, 1/32, 1/16, 1/8, 1/4, and 1/2 of the full interval. |

Table 78. DPLL_0 Fixed Closed Loop Phase Offset

| Address | Bits | Bit Name | Description |
|---------|-------|---------------------------------|--|
| 0x040E | [7:0] | Fixed phase offset (signed; ps) | Fixed phase offset, Bits[7:0] Default: 0x00 |
| 0x040F | [7:0] | | Fixed phase offset, Bits[15:8] Default 0x00 |
| 0x0410 | [7:0] | | Fixed phase offset, Bits[23:16] Default: 0x00 |
| 0x0411 | [7:6] | Reserved | Reserved; default: 0x0 |
| | [5:0] | Fixed phase offset (signed; ps) | Fixed phase offset, Bits[29:24] Default: 0x00 |

Table 79. DPLL_0 Incremental Closed-Loop Phase Offset Step Size¹

| Address | Bits | Bit Name | Description |
|---------|-------|---|--|
| 0x0412 | [7:0] | Incremental phase offset step size (ps) | Incremental phase offset step size, Bits[7:0]. Default: 0x00. This register controls the static phase offset of the DPLL while it is locked. |
| 0x0413 | [7:0] | | Incremental phase offset step size, Bits[15:8]. Default: 0x00. This register controls the static phase offset of the DPLL while it is locked. |

¹ Note that the default incremental closed loop phase lock offset step size value is 0x0000 = 0 (0 ns).

Table 80. DPLL_0 Phase Slew Rate Limit

| Address | Bits | Bit Name | Description |
|---------|-------|--------------------------------|---|
| 0x0414 | [7:0] | Phase slew rate limit (μs/sec) | Phase slew rate limit, Bits[7:0]. Default: 0x00. This register controls the maximum allowable phase slewing during phase adjustment. (The phase adjustment controls are in Register 0x040E to Register 0x0411.) Default phase slew rate limit: 0, or disabled. Minimum useful value is 310 μs/sec. |
| 0x0415 | [7:0] | | Phase slew rate limit, Bits[15:8]. Default = 0x00 |

APLL_0 CONFIGURATION (REGISTER 0x0420 TO REGISTER 0x0423)

Table 81. Output PLL_0 (APLL_0) Setting¹

| Address | Bits | Bit Name | Description | | | |
|---------|----------------------------|------------------------------|--|--------------|--------------|--------------|
| 0x0420 | [7:0] | APLL_0 charge pump current | LSB: 3.5 μ A 00000001 = 1 \times LSB; 00000010 = 2 \times LSB; 11111111 = 255 \times LSB Default: 0x81 = 451 μ A CP current | | | |
| 0x0421 | [7:0] | APLL_0 M0 (feedback) divider | Division: 14 to 255 Default: 0x14 = divide-by-20 | | | |
| 0x0422 | [7:6] | APLL_0 loop filter control | Pole 2 resistor, Rp2; default: 0x07 | | | |
| | | | Rp2 (Ω) | Bit 7 | Bit 6 | |
| | | | 500 (default) | 0 | 0 | |
| | | | 333 | 0 | 1 | |
| | | | | 250 | 1 | 0 |
| | | | | 200 | 1 | 1 |
| | [5:3] | APLL_0 loop filter control | Zero resistor, Rzero | | | |
| | | | Rzero (Ω) | Bit 5 | Bit 4 | Bit 3 |
| | | | 1500 (default) | 0 | 0 | 0 |
| | | | 1250 | 0 | 0 | 1 |
| | | | 1000 | 0 | 1 | 0 |
| | | | 930 | 0 | 1 | 1 |
| | | | 1250 | 1 | 0 | 0 |
| 1000 | | | 1 | 0 | 1 | |
| | | | 750 | 1 | 1 | 0 |
| | | | 680 | 1 | 1 | 1 |
| [2:0] | APLL_0 loop filter control | Pole 1, Cp1 | | | | |
| | | Cp1 (pF) | Bit 2 | Bit 1 | Bit 0 | |
| | | 0 | 0 | 0 | 0 | |
| | | 20 | 0 | 0 | 1 | |
| | | 80 | 0 | 1 | 0 | |
| | | 100 | 0 | 1 | 1 | |
| | | 20 | 1 | 0 | 0 | |
| | | 40 | 1 | 0 | 1 | |
| | | 100 | 1 | 1 | 0 | |
| | | 120 (default) | 1 | 1 | 1 | |
| 0x0423 | [7:1] | Reserved | Default: 0x00. | | | |
| | 0 | Bypass internal Rzero | 0 (default) = use the internal Rzero resistor 1 = bypass the internal Rzero resistor (makes Rzero = 0 and requires the use of a series external zero resistor in addition to the capacitor to ground on the LF_0 pin) | | | |

¹Note that the default APLL loop BW is 240 kHz.

PLL_0 OUTPUT SYNC AND CLOCK DISTRIBUTION (REGISTER 0x0424 TO REGISTER 0x042E)**Table 82. APLL_0 P0 Divider Settings**

| Address | Bits | Bit Name | Description |
|---------|-------|-------------------------|---|
| 0x0424 | [7:4] | Reserved | Default: 0x0 |
| | [3:0] | P0 divider divide ratio | 0000/0001 = 3 0010 = 4 0011 = 5 0100 = 6 (default) 0101 = 7 0110 = 8 0111 = 9 1000 = 10 1001 = 11 |

Table 83. Distribution Output Synchronization Settings

| Address | Bits | Bit Name | Description |
|---------|-------|---------------------------------------|---|
| 0x0425 | [7:3] | Reserved | Default: 00000b |
| | 2 | Sync source selection | Selects the sync source for the clock distribution output channels. 0 (default) = direct. 1 = active reference. |
| | [1:0] | Automatic sync mode | Auto sync mode. 00 = (default) disabled. 01 = sync on DPLL frequency lock. 10 = sync on DPLL phase lock. 11 = reserved. |
| 0x0426 | [7:3] | Reserved | Reserved. |
| | 2 | APLL_0 locked controlled sync disable | 0 (default) = the clock distribution SYNC function is not enabled until the APLL has been calibrated and is locked. After APLL calibration and lock, the output clock distribution sync is armed, and the SYNC function for the clock outputs is under the control of Register 0x0425. 1 = overrides the lock detector state of the APLL; allows Register 0x0425 to control the output SYNC function regardless of the APLL lock status. |
| | 1 | Mask OUT0B sync | Masks the synchronous reset to the OUT0B divider. 0 (default) = unmasked. 1 = masked. Setting this bit asynchronously releases the OUT0B divider from static sync state, thus allowing the OUT0B divider to toggle. OUT0B ignores all sync events while this bit is set. Setting this bit does not enable the output drivers connected to this channel. |
| | 0 | Mask OUT0A sync | Masks the synchronous reset to the OUT0A divider. 0 (default) = unmasked. 1 = masked. Setting this bit asynchronously releases the OUT0A divider from static sync state, thus allowing the OUT0A divider to toggle. OUT0A ignores all sync events while this bit is set. Setting this bit does not enable the output drivers connected to this channel. |

Table 84. Distribution OUT0A Settings

| Address | Bits | Bit Name | Description |
|---------|-------|------------------|---|
| 0x0427 | 7 | Reserved | Default: 0b |
| | [6:4] | OUT0A format | Selects the operating mode of OUT0A. 000 = power-down, tristate. 001 (default) = HSTL. 010 = LVDS. 011 = reserved. 100 = CMOS, both outputs active. 101 = CMOS, P output active, N output power-down. 110 = CMOS, N output active, P output power-down. 111 = reserved. |
| | [3:2] | OUT0A polarity | Controls the OUT0A polarity. 00 (default) = positive, negative. 01 = positive, positive. 10 = negative, positive. 11 = negative, negative. |
| | 1 | OUT0A LVDS boost | Controls the output drive capability of OUT0A. 0 (default) = LVDS: 3.5 mA drive strength. 1 = LVDS: 4.5 mA drive strength (LVDS boost mode). |
| | 0 | Reserved | Default: 0b. |

Table 85. Q0_A Divider Settings

| Address | Bits | Bit Name | Description |
|---------|-------|--------------------|--|
| 0x0428 | [7:0] | Q0_A divider | 10-bit channel divider, Bits[7:0] (LSB). Division equals channel divider, Bits[9:0] + 1. ([9:0] = 0 is divide-by-1, [9:0] = 1 is divide-by-2...[9:0] = 1023 is divide-by-1024) |
| 0x0429 | [7:2] | Reserved | Reserved. |
| | [1:0] | Q0_A divider | 10-bit channel divider, Bits[9:8] (MSB), Bits[1:0]. |
| 0x042A | [7:6] | Reserved | Reserved. |
| | [5:0] | Q0_A divider phase | Divider initial phase after sync relative to the divider input clock (from the P0 divider output). LSB is ½ of a period of the divider input clock. Phase = 0 is no phase offset. Phase = 1 is ½ a period offset. |

Table 86. Distribution OUT0B Settings

| Address | Bits | Bit Name | Description |
|---------|-------|--------------------------|--|
| 0x042B | 7 | Enable 3.3 V CMOS driver | 0 (default) = disables 3.3 V CMOS driver. OUT0B logic is controlled by Register 0x042B[6:4]. 1 = enables 3.3 V CMOS driver as operating mode of OUT0B. This bit should be enabled only if Bits[6:4] are in CMOS mode. |
| | [6:4] | OUT0B format | Select the operating mode of OUT0B. 000 = power-down, tristate. 001 = HSTL. 010 = LVDS. 011 = reserved. 100 = CMOS, both outputs active. 101 = CMOS, P output active, N output power-down. 110 = CMOS, N output active, P output power-down. 111 = reserved. |
| | [3:2] | OUT0B polarity | Configure the OUT0B polarity in CMOS mode. These bits are active in CMOS mode only. 00 (default) = positive, negative. 01 = positive, positive. 10 = negative, positive. 11 = negative, negative. |
| | 1 | OUT0B LVDS boost | Controls the output drive capability of OUT0B. 0 (default) = LVDS: 3.5 mA drive strength. 1 = LVDS: 4.5 mA drive strength (LVDS boost mode). |
| | 0 | Reserved | Default: 0b. |

Table 87. Q0B_B Divider Setting

| Address | Bits | Bit Name | Description |
|---------|-------|--------------------|--|
| 0x042C | [7:0] | Q0_B divider | 10-bit channel divider, Bits[7:0] (LSB). Division equals channel divider, Bits[9:0] + 1. ([9:0] = 0 is divide-by-1, [9:0] = 1 is divide-by-2...[9:0] = 1023 is divide-by-1024). |
| 0x042D | [7:2] | Reserved | Default: 000000b. |
| | [1:0] | Q0_B divider | 10-bit channel divider, Bits[9:8] (MSB), Bits[1:0]. |
| 0x042E | [7:6] | Reserved | Default: 00b. |
| | [5:0] | Q0_B divider phase | Divider initial phase after sync relative to the divider input clock (from the P0 divider output). LSB is 1/2 of a period of the divider input clock. Phase = 0 is no phase offset. Phase = 1 is 1/2 a period offset. |

DPLL_0 SETTINGS FOR REFERENCE INPUT A (REFA) (REGISTER 0x0440 TO REGISTER 0x044C)

Table 88. DPLL_0 REFA Priority Setting

| Address | Bits | Bit Name | Description |
|---------|-------|---------------|--|
| 0x0440 | [7:3] | Reserved | Default: 00000b |
| | [2:1] | REFA priority | These bits set the priority level (0 to 3) of REFA relative to the other input references. 00 (default) = 0 (highest). 01 = 1. 10 = 2. 11 = 3. |
| | 0 | Enable REFA | This bit enables DPLL_0 to lock to REFA. 0 = REFA is not enabled for use by DPLL_0. 1 (default) = REFA is enabled for use by DPLL_0. |

Table 89. DPLL_0 REFA Loop BW Scaling Factor

| Address | Bits | Bit Name | Description |
|---------|-------|--|--|
| 0x0441 | [7:0] | DPLL loop BW scaling factor (unit of 0.1 Hz) | Digital PLL loop bandwidth scaling factor, Bits[7:0] (default: 0xF4). |
| 0x0442 | [7:0] | | Digital PLL loop bandwidth scaling factor, Bits[15:8] (default: 0x01). The default for Register 0x0441 and Register 0x0442 = 0x01F4 = 500 (50 Hz loop BW). The loop bandwidth should always be less than the DPLL phase detector frequency divided by 20. The DPLL may not lock reliably if the DPLL loop BW is <50 Hz and a crystal is used for the system clock. See the Choosing the SYSCLK Source section for details. |
| 0x0443 | [7:2] | Reserved | Default: 0x00. |
| | 1 | Base loop filter selection | 0 = base loop filter with normal (70°) phase margin (default). 1 = base loop filter with high phase margin. (≤0.1 dB peaking in the closed-loop transfer function for loop BW ≤ 2 kHz. Setting this bit is also recommended for loop BW > 2 kHz.) |
| | 0 | Reserved | Default: 0b. |

Table 90. DPLL_0 REFA Integer Part of Feedback Divider

| Address | Bits | Bit Name | Description |
|---------|-------|-----------------|---|
| 0x0444 | [7:0] | Integer Part N0 | DPLL integer feedback divider (minus 1), Bits[7:0] (default: 0xCB) |
| 0x0445 | [7:0] | | DPLL integer feedback divider, Bits[15:8] (default: 0x07) |
| 0x0446 | [7:1] | Reserved | Default: 0x00 |
| | 0 | Integer Part N0 | DPLL integer feedback divider, Bit 16 (default: 0b) Default for Register 0x0444 to Register 0x0446: 0x007CB (which equals N1 = 1996) |

Table 91. DPLL_0 REFA Fractional Part of Fractional Feedback Divider FRAC0

| Address | Bits | Bit Name | Description |
|---------|-------|---|---|
| 0x0447 | [7:0] | Digital PLL fractional feedback divider—FRAC0 | The numerator of the fractional-N feedback divider, Bits[7:0] (default: 0x04) |
| 0x0448 | [7:0] | | The numerator of the fractional-N feedback divider, Bits[15:8] (default: 0x00) |
| 0x0449 | [6:0] | | The numerator of the fractional-N feedback divider, Bits[22:16] (default: 0x00) |
| | 7 | Reserved | Default: 0b |

Table 92. DPLL_0 REFA Modulus of Fractional Feedback Divider MOD0

| Address | Bits | Bit Name | Description |
|---------|-------|---|---|
| 0x044A | [7:0] | Digital PLL feedback divider modulus—MOD0 | The denominator of the fractional-N feedback divider, Bits[7:0] (default: 0x05) |
| 0x044B | [7:0] | | The denominator of the fractional-N feedback divider, Bits[15:8] (default: 0x00) |
| 0x044C | [6:0] | | The denominator of the fractional-N feedback divider, Bits[22:16] (default: 0x00) |
| | 7 | Reserved | Default: 0b |

DPLL_0 SETTINGS FOR REFERENCE INPUT B (REFB) (REGISTER 0x044D TO REGISTER 0x0459)

Table 93. DPLL_0 REFB Priority Setting

| Address | Bits | Bit Name | Description |
|---------|-------|---------------|---|
| 0x044D | [7:3] | Reserved | Default: 00000b. |
| | [2:1] | REFB priority | These bits set the priority level (0 to 3) of REFB relative to the other input references. 00 (default) = 0 (highest). 01 = 1. 10 = 2. 11 = 3. |
| | 0 | Enable REFB | This bit enables DPLL_0 to lock to REFB. 0 = REFB is not enabled for use by DPLL_0. 1 (default) = REFB is enabled for use by DPLL_0. |

Table 94. DPLL_0 REFB Loop BW Scaling Factor

| Address | Bits | Bit Name | Description |
|---------|-------|--|--|
| 0x044E | [7:0] | DPLL loop BW scaling factor (unit of 0.1 Hz) | Digital PLL loop bandwidth scaling factor, Bits[7:0] (default: 0xF4). |
| 0x044F | [7:0] | | Digital PLL loop bandwidth scaling factor, Bits[15:8] (default: 0x01). The default for Register 0x044E and Register 0x044F = 0x01F4 = 500 (50 Hz loop BW). The loop bandwidth should always be less than the DPLL phase detector frequency divided by 20. The DPLL may not lock reliably if the DPLL loop BW is <50 Hz and a crystal is used for the system clock. See the Choosing the SYSCLK Source section for details. |
| 0x0450 | [7:2] | Reserved | Default: 0x00. |
| | 1 | Base loop filter selection | 0 = base loop filter with normal (70°) phase margin (default). 1 = base loop filter with high phase margin. (≤0.1 dB peaking in the closed-loop transfer function for loop BWs ≤ 2 kHz. Setting this bit is also recommended for loop BW > 2 kHz.) |
| | 0 | Reserved | Default: 0b. |

Table 95. DPLL_0 REFB Integer Part of Feedback Divider

| Address | Bits | Bit Name | Description |
|---------|-------|-----------------|--|
| 0x0451 | [7:0] | Integer Part N0 | DPLL integer feedback divider (minus 1), Bits[7:0] (default: 0xCB) |
| 0x0452 | [7:0] | | DPLL integer feedback divider, Bits[15:8] (default: 0x07) |
| 0x0453 | [7:1] | Reserved | Default: 0x00 |
| | 0 | Integer Part N0 | DPLL integer feedback divider, Bit 17 (default: 0b) Default for Register 0x0451 to Register 0x453: 0x007CB (which equals N1 = 1996) |

Table 96. DPLL_0 REFB Fractional Part of Fractional Feedback Divider—FRAC0

| Address | Bits | Bit Name | Description |
|---------|-------|---|---|
| 0x0454 | [7:0] | Digital PLL fractional feedback divider—FRAC0 | The numerator of the fractional-N feedback divider, Bits[7:0] (default: 0x04) |
| 0x0455 | [7:0] | | The numerator of the fractional-N feedback divider, Bits[15:8] (default: 0x00) |
| 0x0456 | [6:0] | | The numerator of the fractional-N feedback divider, Bits[22:16] (default: 0x00) |
| | 7 | Reserved | Default: 0b |

Table 97. DPLL_0 REFB Modulus of Fractional Feedback Divider—MOD0

| Address | Bits | Bit Name | Description |
|---------|-------|---|---|
| 0x0457 | [7:0] | Digital PLL feedback divider modulus—MOD0 | The denominator of the fractional-N feedback divider, Bits[7:0] (default: 0x05) |
| 0x0458 | [7:0] | | The denominator of the fractional-N feedback divider, Bits[15:8] (default: 0x00) |
| 0x0459 | [6:0] | | The denominator of the fractional-N feedback divider, Bits[22:16] (default: 0x00) |
| | 7 | Reserved | Default: 0b |

DPLL_0 SETTINGS FOR REFERENCE INPUT C (REFC) (REGISTER 0x045A TO REGISTER 0x0466)**Table 98. DPLL_0 REFC Priority Setting**

| Address | Bits | Bit Name | Description |
|---------|-------|---------------|--|
| 0x045A | [7:3] | Reserved | Default: 00000b. |
| | [2:1] | REFC priority | These bits set the priority level (0 to 3) of REFC relative to the other input references. 00 (default) = 0 (highest). 01 = 1. 10 = 2. 11 = 3. |
| | 0 | Enable REFC | This bit enables DPLL_0 to lock to REFC. 0 (default) = REFC is not enabled for use by DPLL_0. 1 = REFC is enabled for use by DPLL_0. |

Table 99. DPLL_0 REFC Loop BW Scaling Factor

| Address | Bits | Bit Name | Description |
|---------|-------|---|---|
| 0x045B | [7:0] | DPLL loop BW scaling factor (unit of 0.1 Hz) | Digital PLL loop bandwidth scaling factor, Bits[7:0] (default: 0xF4). |
| 0x045C | [7:0] | | Digital PLL loop bandwidth scaling factor, Bits[15:8] (default: 0x01). The default for Register 0x045B and Register 0x045C: 0x01F4 = 500 (50 Hz loop BW). The loop bandwidth should always be less than the DPLL phase detector frequency divided by 20. The DPLL may not lock reliably if the DPLL loop BW is <50 Hz and a crystal is used for the system clock. See the Choosing the SYSCLK Source section for details. |
| 0x045D | [7:2] | Reserved | Default: 0x00. |
| | 1 | Base loop filter selection | 0 = base loop filter with normal (70°) phase margin (default). 1 = base loop filter with high phase margin. (≤0.1 dB peaking in the closed-loop transfer function for loop BW ≤ 2 kHz. Setting this bit is also recommended for loop BW > 2 kHz.) |
| | 0 | Reserved | Default: 0b. |

Table 100. DPLL_0 REFC Integer Part of Feedback Divider

| Address | Bits | Bit Name | Description |
|---------|-------|-----------------|--|
| 0x045E | [7:0] | Integer Part N0 | DPLL integer feedback divider (minus 1), Bits[7:0] (default: 0xCB). |
| 0x045F | [7:0] | | DPLL integer feedback divider, Bits[15:8] (default: 0x07). |
| 0x0460 | [7:1] | Reserved | Default: 0x00. |
| | 0 | Integer Part N0 | DPLL integer feedback divider, Bit 16 (default: 0b). The default for Register 0x045E to Register 0x460: 0x007CB (which equals N1 = 1996). |

Table 101. DPLL_0 REFC Fractional Part of Fractional Feedback Divider FRAC0

| Address | Bits | Bit Name | Description |
|---------|-------|--|--|
| 0x0461 | [7:0] | Digital PLL fractional feedback divider—FRAC0 | The numerator of the fractional-N feedback divider, Bits[7:0] (default: 0x04). |
| 0x0462 | [7:0] | | The numerator of the fractional-N feedback divider, Bits[15:8] (default: 0x00). |
| 0x0463 | [6:0] | | The numerator of the fractional-N feedback divider, Bits[22:16] (default: 0x00). |
| | 7 | Reserved | Default: 0b |

Table 102. DPLL_0 REFC Modulus of Fractional Feedback Divider MOD0

| Address | Bits | Bit Name | Description |
|---------|-------|--|--|
| 0x0464 | [7:0] | Digital PLL feedback divider modulus—MOD0 | The denominator of the fractional-N feedback divider, Bits[7:0] (default: 0x05). |
| 0x0465 | [7:0] | | The denominator of the fractional-N feedback divider, Bits[15:8] (default: 0x00). |
| 0x0466 | [6:0] | | The denominator of the fractional-N feedback divider, Bits[22:16] (default: 0x00). |
| | 7 | Reserved | Default: 0b |

DPLL_0 SETTINGS FOR REFERENCE INPUT D (REFD) (REGISTER 0x0467 TO REGISTER 0x0473)**Table 103. DPLL_0 REFD Priority Setting**

| Address | Bits | Bit Name | Description |
|---------|-------|---------------|--|
| 0x0467 | [7:3] | Reserved | Default: 00000b. |
| | [2:1] | REFD priority | These bits set the priority level (0 to 3) of REFD relative to the other input references. 00 (default) = 0 (highest). 01 = 1. 10 = 2. 11 = 3. |
| | 0 | Enable REFD | This bit enables DPLL_0 to lock to REFD. 0 (default) = REFD is not enabled for use by DPLL_0. 1 = REFD is enabled for use by DPLL_0. |

Table 104. DPLL_0 REFD Loop BW Scaling Factor

| Address | Bits | Bit Name | Description |
|---------|-------|---|--|
| 0x0468 | [7:0] | DPLL loop BW scaling factor (unit of 0.1 Hz) | Digital PLL loop bandwidth scaling factor, Bits[7:0] (default: 0xF4). |
| 0x0469 | [7:0] | | Digital PLL loop bandwidth scaling factor, Bits[15:8] (default: 0x01). The default for Register 0x0468 and Register 0x0469 = 0x01F4 = 500 (50 Hz loop BW). The loop bandwidth should always be less than the DPLL phase detector frequency divided by 20. The DPLL may not lock reliably if the DPLL loop BW is <50 Hz and a crystal is used for the system clock. See the Choosing the SYSCLK Source section for details. |
| 0x046A | [7:2] | Reserved | Default: 0x00. |
| | 1 | Base loop filter selection | 0 = base loop filter with normal (70°) phase margin (default). 1 = base loop filter with high phase margin. (≤0.1 dB peaking in the closed-loop transfer function for loop BWs ≤ 2 kHz. Setting this bit is also recommended for loop BW > 2 kHz.) |
| | 0 | Reserved | Default: 0b. |

Table 105. DPLL_0 REFD Integer Part of Feedback Divider

| Address | Bits | Bit Name | Description |
|---------|-------|-----------------|--|
| 0x046B | [7:0] | Integer Part N0 | DPLL integer feedback divider (minus 1), Bits[7:0] (default: 0xCB). |
| 0x046C | [7:0] | | DPLL integer feedback divider, Bits[15:8] (default: 0x07). |
| 0x046D | [7:1] | Reserved | Default: 0x00. |
| | 0 | Integer Part N0 | DPLL integer feedback divider, Bit 17 (default: 0b). The default for Register 0x046B to Register 0x46D: 0x007CB (which equals N1 = 1996). |

Table 106. DPLL_0 REFD Fractional Part of Fractional Feedback Divider FRAC0

| Address | Bits | Bit Name | Description |
|---------|-------|--|---|
| 0x046E | [7:0] | Digital PLL fractional feedback divider—FRAC0 | The numerator of the fractional-N feedback divider, Bits[7:0] (default: 0x04) |
| 0x046F | [7:0] | | The numerator of the fractional-N feedback divider, Bits[15:8] (default: 0x00) |
| 0x0470 | [6:0] | | The numerator of the fractional-N feedback divider, Bits[22:16] (default: 0x00) |
| | 7 | Reserved | Default: 0b |

Table 107. DPLL_0 REFD Modulus of Fractional Feedback Divider MOD0

| Address | Bits | Bit Name | Description |
|---------|-------|--|---|
| 0x0471 | [7:0] | Digital PLL feedback divider modulus—MOD0 | The denominator of the fractional-N feedback divider, Bits[7:0] (default: 0x05) |
| 0x0472 | [7:0] | | The denominator of the fractional-N feedback divider, Bits[15:8] (default: 0x00) |
| 0x0473 | [6:0] | | The denominator of the fractional-N feedback divider, Bits[22:16] (default: 0x00) |
| | 7 | Reserved | Default: 0b |

DPLL_1 CONTROLS (REGISTER 0x0500 TO REGISTER 0x0515)**Table 108. DPLL_1 Free Run Frequency Tuning Word**

| Address | Bits | Bit Name | Description |
|---------|-------|---|---|
| 0x0500 | [7:0] | 30-bit free running frequency tuning word | Free running frequency tuning word, Bits[7:0] (default: 0x12) |
| 0x0501 | [7:0] | | Free running frequency tuning word, Bits[15:8] (default: 0x15) |
| 0x0502 | [7:0] | | Free running frequency tuning word, Bits[23:9] (default: 0x64) |
| 0x0503 | [7:6] | Reserved | Default: 00b |
| | [5:0] | 30-bit free running frequency word | Free running frequency tuning word, Bits[29:24] (default: 0x1B) |

Table 109. DPLL_1 Digital Oscillator Control

| Address | Bits | Bit Name | Description |
|---------|-------|-------------------------------------|--|
| 0x0504 | [7:5] | Reserved | Default: 0x0 |
| | [4:0] | Digital oscillator SDM integer part | 0000 to 0011 = invalid 0100 = divide-by-4 0101 = invalid 0110 = divide-by-6 0111 = divide-by-7 1000 = divide-by-8 (default) 1001 = divide-by-9 1010 = divide-by-10 1011 = divide-by-11 1100 = divide-by-12 1101 = divide-by-13 1110 = divide-by-14 1111 = divide-by-15 |

Table 110. DPLL_1 Frequency Clamp

| Address | Bits | Bit Name | Description |
|---------|-------|--|--|
| 0x0505 | [7:0] | Lower limit of pull-in range (expressed as a 20-bit frequency tuning word) | Lower limit pull-in range, Bits[7:0] Default: 0x51 |
| 0x0506 | [7:0] | | Lower limit pull-in range, Bits[15:8] Default: 0xB8 |
| 0x0507 | [7:4] | Reserved | Default: 0x0 |
| | [3:0] | Lower limit of pull-in range | Lower limit pull-in range, Bits[19:16] Default: 0x2 |
| 0x0508 | [7:0] | Upper limit of pull-in range (expressed as a 20-bit frequency tuning word) | Upper limit pull-in range, Bits[7:0] Default: 0x3E |
| 0x0509 | [7:0] | | Upper limit pull-in range, Bits[15:8] Default: 0x0A |
| 0x050A | [7:4] | Reserved | Default: 0x0 |
| | [3:0] | Upper limit of pull-in range | Upper limit pull-in range, Bits[19:16] Default: 0xB |

Table 111. DPLL_1 History Accumulation Timer

| Address | Bits | Bit Name | Description |
|---------|-------|--|---|
| 0x050B | [7:0] | History accumulation timer (expressed in units of ms) | History accumulation timer, Bits[7:0]. Default: 0x0A. For Register 0x050B and Register 0x050C, 0x000A = 10 ms. Maximum: 65 sec. This register controls the amount of tuning word averaging used to determine the tuning word used in holdover. Never program a timer value of 0. Default value: 0x000A = 10 (10 ms). |
| 0x050C | | | History accumulation timer, Bits[15:8]. Default: 0x00. |

Table 112. DPLL_1 History Mode

| Address | Bits | Bit Name | Description |
|---------|-------|------------------------|--|
| 0x050D | [7:5] | Reserved | Reserved. |
| | 4 | Single sample fallback | Controls holdover history. If tuning word history is not available for the reference that was active just prior to holdover, then: 0 (default) = use the free running frequency tuning word register value. 1 = use the last tuning word from the DPLL. |
| | 3 | Persistent history | Controls holdover history initialization. When switching to a new reference: 0 (default) = clear the tuning word history. 1 = retain the previous tuning word history. |
| | [2:0] | Incremental average | History mode value from 0 to 7 (default = 0) When set to nonzero, causes the first history accumulation to update prior to the first complete averaging period. After the first full interval, updates occur only at the full period. 0 (default) = update only after the full interval has elapsed. 1 = update at 1/2 the full interval. 2 = update at 1/4 and 1/2 of the full interval. 3 = update at 1/8, 1/4, and 1/2 of the full interval. ... 7 = update at 1/256, 1/128, 1/64, 1/32, 1/16, 1/8, 1/4, and 1/2 of the full interval. |

Table 113. DPLL_1 Fixed Closed Loop Phase Offset

| Address | Bits | Bit Name | Description |
|---------|-------|---------------------------------|--|
| 0x050E | [7:0] | Fixed phase offset (signed; ps) | Fixed phase offset, Bits[7:0] Default: 0x00 |
| 0x050F | [7:0] | | Fixed phase offset, Bits[15:8] Default: 0x00 |
| 0x0510 | [7:0] | | Fixed phase offset, Bits[23:16] Default: 0x00 |
| 0x0511 | [7:6] | Reserved | Reserved; default: 0x0 |
| | [5:0] | Fixed phase offset (signed; ps) | Fixed phase offset, Bits[29:24] Default: 0x00 |

Table 114. DPLL_1 Incremental Closed-Loop Phase Offset Step Size¹

| Address | Bits | Bit Name | Description |
|---------|-------|---|---|
| 0x0512 | [7:0] | Incremental phase offset step size (ps) | Incremental phase offset step size, Bits[7:0]. Default: 0x00. This register controls the static phase offset of the DPLL while it is locked. |
| 0x0513 | [7:0] | | Incremental phase offset step size, Bits[15:8]. Default: 0x00. This register controls the static phase offset of the DPLL while it is locked. |

¹ Note that the default incremental closed loop phase lock offset step size value is 0x0000 = 0 (0 ns).

Table 115. DPLL_1 Phase Slew Rate Limit

| Address | Bits | Bit Name | Description |
|---------|-------|--------------------------------|--|
| 0x0514 | [7:0] | Phase slew rate limit (μs/sec) | Phase slew rate limit, Bits[7:0]. Default: 0x00. This register controls the maximum allowable phase slewing during phase adjustment (The phase adjustment controls are in Register 0x050E to Register 0x0511.) Default phase slew rate limit: 0, or disabled. Minimum useful value is 310 μs/sec. |
| 0x0515 | [7:0] | | Phase slew rate limit, Bits[15:8]. Default = 0x00. |

APLL_1 CONFIGURATION (REGISTER 0x0520 TO REGISTER 0x0523)

Table 116. Output PLL_1 (APLL_1) Setting¹

| Address | Bits | Bit Name | Description | | | |
|---------|-------|------------------------------|---|--------------|--------------|---------------|
| 0x0520 | [7:0] | APLL_1 charge pump current | LSB = 3.5 μ A 00000001 = 1 \times LSB; 00000010 = 2 \times LSB; 11111111 = 255 \times LSB Default: 0x81 = 451 μ A CP current | | | |
| 0x0521 | [7:0] | APLL_1 M1 (feedback) divider | Division: 14 to 255 Default: 0x14 = divide-by-20 | | | |
| 0x0522 | [7:6] | APLL_1 loop filter control | Pole 2 resistor, Rp2; default: 0x07 | | | |
| | | | Rp2 (Ω) | Bit 7 | Bit 6 | |
| | | | 500 (default) | 0 | 0 | |
| | | | 333 | 0 | 1 | |
| | | | | 250 | 1 | 0 |
| | | | | 200 | 1 | 1 |
| | [5:3] | APLL_1 loop filter control | Zero resistor, Rzero. | | | |
| | | | Rzero (Ω) | Bit 5 | Bit 4 | Bit 3 |
| | | | 1500 (default) | 0 | 0 | 0 |
| | | | 1250 | 0 | 0 | 1 |
| 1000 | | | 0 | 1 | 0 | |
| 930 | | | 0 | 1 | 1 | |
| 1250 | | | 1 | 0 | 0 | |
| | | | 1000 | 1 | 1 | |
| | | | 750 | 1 | 0 | |
| | | | 680 | 1 | 1 | |
| 0x0523 | [2:0] | APLL_1 loop filter control | Pole 1, Cp1. | | | |
| | | | Cp1 (pF) | Bit 2 | Bit 1 | Bit 0 |
| | | | 0 | 0 | 0 | 0 |
| | | | 20 | 0 | 0 | 1 |
| | | | 80 | 0 | 1 | 0 |
| | | | 100 | 0 | 1 | 1 |
| | | | 20 | 1 | 0 | 0 |
| | | | 40 | 1 | 0 | 1 |
| | | | 100 | 1 | 1 | 0 |
| | | | | | | 120 (default) |
| 0x0523 | [7:1] | Reserved | Default: 0x00 | | | |
| | 0 | Bypass internal Rzero | 0 (default) = uses the internal Rzero resistor 1 = bypasses the internal Rzero resistor (makes Rzero = 0 and requires the use of a series external zero resistor in addition to the capacitor to ground on the LF_1 pin) | | | |

¹ Note that the default APLL loop BW is 240 kHz.

PLL_1 OUTPUT SYNC AND CLOCK DISTRIBUTION (REGISTER 0x0524 TO REGISTER 0x052E)

Table 117. APLL_1 P1 Divider Settings

| Address | Bits | Bit Name | Description |
|---------|-------|-------------------------|---|
| 0x0524 | [7:4] | Reserved | Default: 0x0 |
| | [3:0] | P1 divider divide ratio | 0000/0001 = 3 0010 = 4 0011 = 5 0100 = 6 (default) 0101 = 7 0110 = 8 0111 = 9 1000 = 10 1001 = 11 |

Table 118. Distribution Output Synchronization Settings

| Address | Bits | Bit Name | Description |
|---------|-------|---------------------------------------|---|
| 0x0525 | [7:3] | Reserved | Default: 00000b. |
| | 2 | Sync source selection | Selects the sync source for the clock distribution output channels. 0 (default) = direct. 1 = active reference. |
| | [1:0] | Automatic sync mode | Automatic sync mode. 00 (default) = disabled. 01 = sync on DPLL frequency lock. 10 = sync on DPLL phase lock. 11 = reserved. |
| 0x0526 | [7:3] | Reserved | Default: 00000b. |
| | 2 | APLL_1 locked controlled sync disable | 0 (default) = the clock distribution SYNC function is not enabled until APLL_1 has been calibrated and is locked. After APLL calibration and lock, the output clock distribution sync is armed, and the SYNC function for the clock outputs is under the control of Register 0x0525. 1 = overrides the lock detector state of the APLL; allows Register 0x0525 to control the output SYNC function regardless of the APLL lock status. |
| | 1 | Mask OUT1B sync | Masks the synchronous reset to the OUT1B divider. 0 (default) = unmasked. 1 = masked. Setting this bit asynchronously releases the OUT1B divider from the static SYNC state, thus allowing the OUT1B divider to toggle. OUT1B ignores all SYNC events while this bit is set. Setting this bit does not enable the output drivers connected to this channel. |
| | 0 | Mask OUT1A sync | Masks the synchronous reset to the OUT1A divider. 0 (default) = unmasked. 1 = masked. Setting this bit asynchronously releases the OUT1A divider from the static SYNC state, thus allowing the OUT1A divider to toggle. OUT1A ignores all SYNC events while this bit is set. Setting this bit does not enable the output drivers connected to this channel. |

Table 119. Distribution OUT1A Settings

| Address | Bits | Bit Name | Description |
|---------|-------|------------------|--|
| 0x0527 | 7 | Reserved | Default: 0b. |
| | [6:4] | OUT1A format | Select the operating mode of OUT1A. 000 = power-down, tristate. 001 (default) = HSTL. 010 = LVDS. 011 = reserved. 100 = CMOS, both outputs active. 101 = CMOS, P output active, N output power-down. 110 = CMOS, N output active, P output power-down. 111 = reserved. |
| | [3:2] | OUT1A polarity | Control the OUT1A polarity. 00 (default) = positive, negative. 01 = positive, positive. 10 = negative, positive. 11 = negative, negative. |
| | 1 | OUT1A LVDS boost | Controls the output drive capability of OUT1A. 0 (default) = LVDS: 3.5 mA drive strength. 1 = LVDS: 4.5 mA drive strength (LVDS boost mode). |
| | 0 | Reserved | Default: 0b. |

Table 120. Q1_A Divider Settings

| Address | Bits | Bit Name | Description |
|---------|-------|--------------------|--|
| 0x0528 | [7:0] | Q1_A divider | 10-bit channel divider, Bits[7:0] (LSB). Division equals channel divider, Bits[9:0] + 1. ([9:0] = 0 is divide-by-1, [9:0] = 1 is divide-by-2... [9:0] = 1023 is divide-by-1024). |
| 0x0529 | [7:2] | Reserved | Reserved. |
| | [1:0] | Q1_A divider | 10-bit channel divider, Bits[9:8] (MSB), Bits[1:0]. |
| 0x052A | [7:6] | Reserved | Reserved. |
| | [5:0] | Q1_A divider phase | Divider initial phase after sync relative to the divider input clock (from the P1 divider output). LSB is $\frac{1}{2}$ of a period of the divider input clock. Phase = 0 is no phase offset. Phase = 1 is $\frac{1}{2}$ a period offset. |

Table 121. Distribution OUT1B Settings

| Address | Bits | Bit Name | Description |
|---------|-------|--------------------------|--|
| 0x052B | 7 | Enable 3.3 V CMOS driver | 0 (default) = disables 3.3 V CMOS driver, and OUT1B logic is controlled by 0x052B[6:4]. 1 = enables 3.3 V CMOS driver as operating mode of OUT1. This bit should be enabled only if Bits[6:4] are in CMOS mode. |
| | [6:4] | OUT1B format | Select the operating mode of OUT1B. 000 = power-down, tristate. 001 = HSTL. 010 = LVDS. 011 = reserved. 100 = CMOS, both outputs active. 101 = CMOS, P output active, N output power-down. 110 = CMOS, N output active, P output power-down. 111 = reserved. |
| | [3:2] | OUT1B polarity | Configure the OUT1B polarity in CMOS mode. These bits are active in CMOS mode only. 00 (default) = positive, negative. 01 = positive, positive. 10 = negative, positive. 11 = negative, negative. |
| | 1 | OUT1B LVDS boost | Controls the output drive capability of OUT1B. 0 (default) = LVDS: 3.5 mA drive strength. 1 = LVDS: 4.5 mA drive strength (LVDS boost mode). |
| | 0 | Reserved | Default: 0b. |

Table 122. OUT1B Divider Setting

| Address | Bits | Bit Name | Description |
|---------|-------|--------------------|--|
| 0x052C | [7:0] | Q1_B divider | 10-bit channel divider, Bits[7:0] (LSB). Division equals channel divider, Bits[9:0] + 1. ([9:0] = 0 is divide-by-1, [9:0] = 1 is divide-by-2...[9:0] = 1023 is divide-by-1024). |
| 0x052D | [7:2] | Reserved | Default: 000000b. |
| | [1:0] | Q1_B divider | 10-bit channel divider, Bits[9:8] (MSB), Bits[1:0]. |
| 0x052E | [7:6] | Reserved | Default: 00b. |
| | [5:0] | Q1_B divider phase | Divider initial phase after sync relative to the divider input clock (from the P1 divider output). LSB is ½ of a period of the divider input clock. Phase = 0 is no phase offset. Phase = 1 is ½ a period offset. |

DPLL_1 SETTINGS FOR REFERENCE INPUT C (REFC) (REGISTER 0x0540 TO REGISTER 0x054C)

Table 123. DPLL_1 REFC Priority Setting

| Address | Bits | Bit Name | Description |
|---------|-------|---------------|--|
| 0x0540 | [7:3] | Reserved | Reserved. |
| | [2:1] | REFC priority | These bits set the priority level (0 to 3) of REFC relative to the other input references. 00 (default) = 0 (highest). 01 = 1. 10 = 2. 11 = 3. |
| | 0 | Enable REFC | This bit enables DPLL_1 to lock to REFC. 0 = REFC is not enabled for use by DPLL_1. 1 (default) = REFC is enabled for use by DPLL_1. |

Table 124. DPLL_1 REFC Loop BW Scaling Factor

| Address | Bits | Bit Name | Description |
|---------|-------|---|---|
| 0x0541 | [7:0] | DPLL loop BW scaling factor (unit of 0.1 Hz) | Digital PLL loop bandwidth scaling factor, Bits[7:0] (default: 0xF4). |
| 0x0542 | [7:0] | | Digital PLL loop bandwidth scaling factor, Bits[15:8] (default: 0x01). Default for Register 0x0541 and Register 0x0542: 0x01F4 = 500 (50 Hz loop BW). The loop bandwidth should always be less than the DPLL phase detector frequency divided by 20. The DPLL may not lock reliably if the DPLL loop BW is <50 Hz and a crystal is used for the system clock. See the Choosing the SYSCLK Source section for details. |
| 0x0543 | [7:2] | Reserved | Default: 0x00. |
| | 1 | Base loop filter selection | 0 = base loop filter with normal (70°) phase margin (default). 1 = base loop filter with high phase margin. (≤0.1 dB peaking in the closed-loop transfer function for loop BW ≤ 2 kHz. Setting this bit is also recommended for loop BW > 2 kHz.) |
| | 0 | Reserved | Default: 0b. |

Table 125. DPLL_1 REFC Integer Part of Feedback Divider

| Address | Bits | Bit Name | Description |
|---------|-------|-----------------|---|
| 0x0544 | [7:0] | Integer Part N1 | DPLL integer feedback divider (minus 1), Bits[7:0] (default: 0xCB). |
| 0x0545 | [7:0] | | DPLL integer feedback divider, Bits[15:8] (default: 0x07). |
| 0x0546 | [7:1] | Reserved | Default: 0x00. |
| | 0 | Integer Part N1 | DPLL integer feedback divider, Bit 16 (default: 0b). Default for Register 0x0544 to Register 0x0546: 0x007CB (which equals N1 = 1996). |

Table 126. DPLL_1 REFC Fractional Part of Fractional Feedback Divider FRAC1

| Address | Bits | Bit Name | Description |
|---------|-------|--|---|
| 0x0547 | [7:0] | Digital PLL fractional feedback divider—FRAC1 | The numerator of the fractional-N feedback divider, Bits[7:0] (default: 0x04) |
| 0x0548 | [7:0] | | The numerator of the fractional-N feedback divider, Bits[15:8] (default: 0x00) |
| 0x0549 | [6:0] | | The numerator of the fractional-N feedback divider, Bits[22:16] (default: 0x00) |
| | 7 | Reserved | Default: 0b |

Table 127. DPLL_1 REFC Modulus of Fractional Feedback Divider Mod1

| Address | Bits | Bit Name | Description |
|---------|-------|---|---|
| 0x054A | [7:0] | Digital PLL feedback divider modulus—MOD1 | The denominator of the fractional-N feedback divider, Bits[7:0] (default: 0x05) |
| 0x054B | [7:0] | | The denominator of the fractional-N feedback divider, Bits[15:8] (default: 0x00) |
| 0x054C | [6:0] | | The denominator of the fractional-N feedback divider, Bits[22:16] (default: 0x00) |
| | 7 | Reserved | Default: 0b |

DPLL_1 SETTINGS FOR REFERENCE INPUT D (REFD) (REGISTER 0x054D TO REGISTER 0x0559)

Table 128. DPLL_1 REFD Priority Setting

| Address | Bits | Bit Name | Description |
|---------|-------|---------------|--|
| 0x054D | [7:3] | Reserved | Default: 00000b. |
| | [2:1] | REFD priority | These bits set the priority level (0 to 3) of REFD relative to the other input references. 00 (default) = 0 (highest). 01 = 1 10 = 2 11 = 3 |
| | 0 | Enable REFD | This bit enables DPLL_1 to lock to REFD. 0 = REFD is not enabled for use by DPLL_1 1 (default) = REFD is enabled for use by DPLL_1 |

Table 129. DPLL_1 REFD Loop BW Scaling Factor

| Address | Bits | Bit Name | Description |
|---------|-------|--|--|
| 0x054E | [7:0] | DPLL loop BW scaling factor (unit of 0.1 Hz) | Digital PLL loop bandwidth scaling factor, Bits[7:0] (default: 0xF4). |
| 0x054F | [7:0] | | Digital PLL loop bandwidth scaling factor, Bits[15:8] (default: 0x01). The default for Register 0x054E and Register 0x054F = 0x01F4 = 500 (50 Hz loop BW). The loop bandwidth should always be less than the DPLL phase detector frequency divided by 20. The DPLL may not lock reliably if the DPLL loop BW is <50 Hz and a crystal is used for the system clock. See the Choosing the SYSCLK Source section for details. |
| 0x0550 | [7:2] | Reserved | Default: 0x00. |
| | 1 | Base loop filter selection | 0 = base loop filter with normal (70°) phase margin (default). 1 = base loop filter with high phase margin. (≤0.1 dB peaking in the closed-loop transfer function for loop BW ≤ 2 kHz. Setting this bit is also recommended for loop BW > 2 kHz.) |
| | 0 | Reserved | Default: 0b. |

Table 130. DPLL_1 REFD Integer Part of Feedback Divider

| Address | Bits | Bit Name | Description |
|---------|-------|-----------------|---|
| 0x0551 | [7:0] | Integer Part N1 | DPLL integer feedback divider (minus 1), Bits[7:0] (default: 0xCB). |
| 0x0552 | [7:0] | | DPLL integer feedback divider, Bits[15:8] (default: 0x07). |
| 0x0553 | [7:1] | Reserved | Default: 0x00. |
| | 0 | Integer Part N1 | DPLL integer feedback divider, Bit 16 (default: 0b). The default for Register 0x0551 to Register 0x0553: 0x007CB (which equals N1 = 1996). |

Table 131. DPLL_1 REFD Fractional Part of Fractional Feedback Divider FRAC1

| Address | Bits | Bit Name | Description |
|---------|-------|---|---|
| 0x0554 | [7:0] | Digital PLL fractional feedback divider—FRAC1 | The numerator of the fractional-N feedback divider, Bits[7:0] (default: 0x04) |
| 0x0555 | [7:0] | | The numerator of the fractional-N feedback divider, Bits[15:8] (default: 0x00) |
| 0x0556 | [6:0] | | The numerator of the fractional-N feedback divider, Bits[22:16] (default: 0x00) |
| | 7 | Reserved | Default: 0b |

Table 132. DPLL_1 REFD Modulus of Fractional Feedback Divider MOD1

| Address | Bits | Bit Name | Description |
|---------|-------|---|---|
| 0x0557 | [7:0] | Digital PLL feedback divider modulus—MOD1 | The denominator of the fractional-N feedback divider, Bits[7:0] (default: 0x05) |
| 0x0558 | [7:0] | | The denominator of the fractional-N feedback divider, Bits[15:8] (default: 0x00) |
| 0x0559 | [6:0] | | The denominator of the fractional-N feedback divider, Bits[22:16] (default: 0x00) |
| | 7 | Reserved | Default: 0b |

DPLL_1 SETTINGS FOR REFERENCE INPUT A (REFA) (REGISTER 0x055A TO REGISTER 0x0566)**Table 133. DPLL_1 REFA Priority Setting**

| Address | Bits | Bit Name | Description |
|---------|-------|---------------|--|
| 0x055A | [7:3] | Reserved | Default: 00000b. |
| | [2:1] | REFA priority | These bits set the priority level (0 to 3) of REFA relative to the other input references. 00 (default) = 0 (highest). 01 = 1. 10 = 2. 11 = 3. |
| | 0 | Enable REFA | This bit enables DPLL_1 to lock to REFA. 0 (default) = REFA is not enabled for use by DPLL_1. 1 = REFA is enabled for use by DPLL_1. |

Table 134. DPLL_1 REFA Loop BW Scaling Factor

| Address | Bits | Bit Name | Description |
|---------|-------|---|--|
| 0x055B | [7:0] | DPLL loop BW scaling factor (unit of 0.1 Hz) | Digital PLL loop bandwidth scaling factor, Bits[7:0] (default: 0xF4). |
| 0x055C | [7:0] | | Digital PLL loop bandwidth scaling factor, Bits[15:8] (default: 0x01). The default for Register 0x055B and Register 0x055C = 0x01F4 = 500 (50 Hz loop BW). The loop bandwidth should always be less than the DPLL phase detector frequency divided by 20. The DPLL may not lock reliably if the DPLL loop BW is <50 Hz and a crystal is used for the system clock. See the Choosing the SYSCLK Source section for details. |
| 0x055D | [7:2] | Reserved | Default: 0x00. |
| | 1 | Base loop filter selection | 0 = base loop filter with normal (70°) phase margin (default). 1 = base loop filter with high phase margin. (≤0.1 dB peaking in the closed-loop transfer function for loop BW ≤ 2 kHz. Setting this bit is also recommended for loop BW > 2 kHz.) |
| | 0 | Reserved | Default: 0b. |

Table 135. DPLL_1 REFA Integer Part of Feedback Divider

| Address | Bits | Bit Name | Description |
|---------|-------|-----------------|---|
| 0x055E | [7:0] | Integer Part N1 | DPLL integer feedback divider (minus 1), Bits[7:0] (default: 0xCB). |
| 0x055F | [7:0] | | DPLL integer feedback divider, Bits[15:8] (default: 0x07). |
| 0x0560 | [7:1] | Reserved | Default: 0x00. |
| | 0 | Integer Part N1 | DPLL integer feedback divider, Bit 16 (default: 0b). The default for Register 0x055E to Register 0x0560: 0x007CB (which equals N1 = 1996). |

Table 136. DPLL_1 REFA Fractional Part of Fractional Feedback Divider FRAC1

| Address | Bits | Bit Name | Description |
|---------|-------|--|---|
| 0x0561 | [7:0] | Digital PLL fractional feedback divider—FRAC1 | The numerator of the fractional-N feedback divider, Bits[7:0] (default: 0x04) |
| 0x0562 | [7:0] | | The numerator of the fractional-N feedback divider, Bits[15:8] (default: 0x00) |
| 0x0563 | [6:0] | | The numerator of the fractional-N feedback divider, Bits[22:16] (default: 0x00) |
| | 7 | Reserved | Default: 0b |

Table 137. DPLL_1 REFA Modulus of Fractional Feedback Divider MOD1

| Address | Bits | Bit Name | Description |
|---------|-------|--|---|
| 0x0564 | [7:0] | Digital PLL feedback divider modulus—MOD1 | The denominator of the fractional-N feedback divider, Bits[7:0] (default: 0x05) |
| 0x0565 | [7:0] | | The denominator of the fractional-N feedback divider, Bits[15:8] (default: 0x00) |
| 0x0566 | [6:0] | | The denominator of the fractional-N feedback divider, Bits[22:16] (default: 0x00) |
| | 7 | Reserved | Default: 0b |

DPLL_1 SETTINGS FOR REFERENCE INPUT B (REFB) (REGISTER 0x0567 TO REGISTER 0x0573)**Table 138. DPLL_1 REFB Priority Setting**

| Address | Bits | Bit Name | Description |
|---------|-------|---------------|--|
| 0x0567 | [7:3] | Reserved | Default: 00000b. |
| | [2:1] | REFB priority | These bits set the priority level (0 to 3) of REFA relative to the other input references. 00 (default) = 0 (highest). 01 = 1. 10 = 2. 11 = 3. |
| | 0 | Enable REFB | This bit enables DPLL_1 to lock to REFB. 0 (default) = REFB is not enabled for use by DPLL_1. 1 = REFB is enabled for use by DPLL_1. |

Table 139. DPLL_1 REFB Loop BW Scaling Factor

| Address | Bits | Bit Name | Description |
|---------|-------|---|--|
| 0x0568 | [7:0] | DPLL loop BW scaling factor (unit of 0.1 Hz) | Digital PLL loop bandwidth scaling factor, Bits[7:0] (default: 0xF4). |
| 0x0569 | [7:0] | | Digital PLL loop bandwidth scaling factor, Bits[15:8] (default: 0x01). Default for Register 0x0568 to Register 0x056A: 0x01F4 = 500 (50 Hz loop BW). The loop bandwidth should always be less than the DPLL phase detector frequency divided by 20. The DPLL may not lock reliably if the DPLL loop BW is <50 Hz and a crystal oscillator is used for the system clock. See the Choosing the SYSCLK Source section for more information. |
| 0x056A | [7:2] | Reserved | Default: 0x00. |
| | 1 | Base loop filter selection | 0 = base loop filter with normal (70°) phase margin (default). 1 = base loop filter with high phase margin. (≤0.1 dB peaking in the closed-loop transfer function for loop BWs ≤ 2 kHz. Setting this bit is also recommended for loop BW > 2kHz.) |
| | 0 | Reserved | Default: 0b. |

Table 140. DPLL_1 REFB Integer Part of Feedback Divider

| Address | Bits | Bit Name | Description |
|---------|-------|-----------------|---|
| 0x056B | [7:0] | Integer Part N1 | DPLL integer feedback divider (minus 1), Bits[7:0] (default: 0xCB) |
| 0x056C | [7:0] | | DPLL integer feedback divider, Bits[15:8] (default: 0x07) |
| 0x056D | [7:1] | Reserved | Default: 0x00 |
| | 0 | Integer Part N1 | DPLL integer feedback divider, Bit 16 (default: 0b) Default for Register 0x056B to Register 0x056D: 0x007CB (which equals N1 = 1996) |

Table 141. DPLL_1 REFB Fractional Part of Fractional Feedback Divider FRAC1

| Address | Bits | Bit Name | Description |
|---------|-------|--|---|
| 0x056E | [7:0] | Digital PLL fractional feedback divider—FRAC1 | The numerator of the fractional-N feedback divider, Bits[7:0] (default: 0x04) |
| 0x056F | [7:0] | | The numerator of the fractional-N feedback divider, Bits[15:8] (default: 0x00) |
| 0x0570 | [6:0] | | The numerator of the fractional-N feedback divider, Bits[22:16] (default: 0x00) |
| | 7 | Reserved | Default: 0b. |

Table 142. DPLL_1 REFB Modulus of Fractional Feedback Divider MOD1

| Address | Bits | Bit Name | Description |
|---------|-------|--|---|
| 0x0571 | [7:0] | Digital PLL feedback divider modulus—MOD1 | The denominator of the fractional-N feedback divider, Bits[7:0] (default: 0x05) |
| 0x0572 | [7:0] | | The denominator of the fractional-N feedback divider, Bits[15:8] (default: 0x00) |
| 0x0573 | [6:0] | | The denominator of the fractional-N feedback divider, Bits[22:16] (default: 0x00) |
| | 7 | Reserved | Default: 0b. |

DIGITAL LOOP FILTER COEFFICIENTS (REGISTER 0x0800 TO REGISTER 0x0817)**Table 143. Base Digital Loop Filter with Normal Phase Margin (PM = 70°, BW = 0.1 Hz, Third Pole Frequency = 1 Hz, N1 = 1)¹**

| Address | Bits | Bit Name | Description |
|---------|-------|----------------------|--|
| 0x0800 | [7:0] | NPM Alpha-0 linear | Alpha-0 coefficient linear, Bits[7:0]; default: 0x24 |
| 0x0801 | [7:0] | | Alpha-0 coefficient linear, Bits[15:8]; default: 0x8C |
| 0x0802 | 7 | Reserved | Default: 0b |
| | [6:0] | NPM Alpha-1 exponent | Alpha-1 coefficient exponent, Bits[6:0]; default: 0x49 |
| 0x0803 | [7:0] | NPM Beta-0 linear | Beta-0 coefficient linear, Bits[7:0]; default: 0x55 |
| 0x0804 | [7:0] | | Beta-0 coefficient linear, Bits[15:8]; default: 0xC9 |
| 0x0805 | 7 | Reserved | Default: 0b |
| | [6:0] | NPM Beta-1 exponent | Beta-1 coefficient exponent, Bits[6:0]; default: 0x7B |
| 0x0806 | [7:0] | NPM Gamma-0 linear | Gamma-0 coefficient linear, Bits[7:0]; default: 0x9C |
| 0x0807 | [7:0] | | Gamma-0 coefficient linear, Bits[15:8]; default: 0xFA |
| 0x0808 | 7 | Reserved | Default: 0b |
| | [6:0] | NPM Gamma-1 exponent | Gamma-1 coefficient exponent, Bits[6:0]; default: 0x55 |
| 0x0809 | [7:0] | NPM Delta-0 linear | Delta-0 coefficient linear, Bits[7:0]; default: 0xEA |
| 0x080A | [7:0] | | Delta-0 coefficient linear, Bits[15:8]; default: 0xE2 |
| 0x080B | 7 | Reserved | Default: 0b |
| | [6:0] | NPM Delta-1 exponent | Delta-1 coefficient exponent, Bits[6:0]; default: 0x57 |

¹Note that the digital loop filter base coefficients (α , β , γ , and δ) have the general form: $x(2^y)$, where x is the linear component and y is the exponential component of the coefficient. The value of the linear component (x) constitutes a fraction, where $0 \leq x \leq 1$. The exponential component (y) is a signed integer. These are live registers; therefore, an IO_UPDATE is not needed. However, the updated coefficients do not take effect while the loop is locked.

Table 144. Base Digital Loop Filter with High Phase Margin (PM = 88.5°, BW = 0.1 Hz, Third Pole Frequency = 20 Hz, N1 = 1)¹

| Address | Bits | Bit Name | Description |
|---------|-------|----------------------|--|
| 0x080C | [7:0] | HPM Alpha-0 linear | Alpha-0 coefficient linear, Bits[7:0]; default = 0x8C |
| 0x080D | [7:0] | | Alpha-0 coefficient linear, Bits[15:8]; default: 0xAD |
| 0x080E | 7 | Reserved | Default: 0b |
| | [6:0] | HPM Alpha-1 exponent | Alpha-1 coefficient exponent, Bits[6:0]; default: 0x4C |
| 0x080F | [7:0] | HPM Beta-0 linear | Beta-0 coefficient linear, Bits[7:0]; default: 0xF5 |
| 0x0810 | [7:0] | | Beta-0 coefficient linear, Bits[15:8]; default: 0xCB |
| 0x0811 | 7 | Reserved | Default: 0b |
| | [6:0] | HPM Beta-1 exponent | Beta-1 coefficient exponent, Bits[6:0]; default: 0x73 |
| 0x0812 | [7:0] | HPM Gamma-0 linear | Gamma-0 coefficient linear, Bits[7:0]; default: 0x24 |
| 0x0813 | [7:0] | | Gamma-0 coefficient linear, Bits[15:8]; default: 0xD8 |
| 0x0814 | 7 | Reserved | Default: 0b |
| | [6:0] | HPM Gamma-1 exponent | Gamma-1 coefficient exponent, Bits[6:0]; default: 0x59 |
| 0x0815 | [7:0] | HPM Delta-0 linear | Delta-0 coefficient linear, Bits[7:0]; default: 0xD2 |
| 0x0816 | [7:0] | | Delta-0 coefficient linear, Bits[15:8]; default: 0x8D |
| 0x0817 | 7 | Reserved | Default: 0b |
| | [6:0] | HPM Delta-1 exponent | Delta-1 coefficient exponent, Bits[6:0]; default: 0x5A |

¹Note that the base digital loop filter coefficients (α , β , γ , and δ) have the general form: $x(2^y)$, where x is the linear component and y is the exponential component of the coefficient. The value of the linear component (x) constitutes a fraction, where $0 \leq x \leq 1$. The exponential component (y) is a signed integer. These are live registers; therefore, an IO_UPDATE is not needed. However, the updated coefficients do not take effect while the loop is locked.

COMMON OPERATIONAL CONTROLS (REGISTER 0x0A00 TO REGISTER 0x0A0E)**Table 145. Global Operational Controls**

| Address | Bits | Bit Name | Description |
|---------|-------|----------------|--|
| 0x0A00 | [7:3] | Reserved | Default: 00000b. |
| | 2 | Soft sync all | Setting this bit initiates synchronization of all clock distribution outputs (default = 0b). Nonmasked outputs stall when value is 1; restart is initialized on a 1-to-0 transition. |
| | 1 | Calibrate all | Calibrates both output PLL0 (APLL_0) and output PLL1 (APLL_1). |
| | 0 | Power down all | Places the entire device in deep sleep mode (default: device is not powered down). |

Table 146. Reference Input Power-down

| Address | Bits | Bit Name | Description |
|---------|-------|-----------------|---|
| 0x0A01 | [7:4] | Reserved | Default: 0x0 |
| | 3 | REFD power-down | Powers down REFD input receiver 0 (default) = not powered down 1 = powered down |
| | 2 | REFC power-down | Powers down REFC input receiver 0 (default) = not powered down 1 = powered down |
| | 1 | REFB power-down | Powers down REFB input receiver 0 (default) = not powered down 1 = powered down |
| | 0 | REFA power-down | Powers down REFA input receiver 0 (default) = not powered down 1 = powered down |

Table 147. Reference Input Validation Timeout

| Address | Bits | Bit Name | Description |
|---------|-------|--------------------------|--|
| 0x0A02 | [7:4] | Reserved | Default: 0x0 |
| | 3 | REFD timeout (autoclear) | If REFD is unfaulted, setting this autoclearing bit forces the reference validation timer for REFD to zero, thus making it valid immediately (default = 0b). |
| | 2 | REFC timeout (autoclear) | If REFC is unfaulted, setting this autoclearing bit forces the reference validation timer for REFC to zero, thus making it valid immediately (default = 0b). |
| | 1 | REFB timeout (autoclear) | If REFB is unfaulted, setting this autoclearing bit forces the reference validation timer for REFB to zero, thus making it valid immediately (default = 0b). |
| | 0 | REFA timeout (autoclear) | If REFA is unfaulted, setting this autoclearing bit forces the reference validation timer for REFA to zero, thus making it valid immediately (default = 0b). |

Table 148. Force Reference Input Fault

| Address | Bits | Bit Name | Description |
|---------|-------|------------|---|
| 0x0A03 | [7:4] | Reserved | Default: 0x0 |
| | 3 | REFD fault | Faults REFD input receiver 0 (default) = not faulted 1 = faulted (REFD is not used) |
| | 2 | REFC fault | Faults REFC input receiver 0 (default) = not faulted 1 = faulted (REFC is not used) |
| | 1 | REFB fault | Faults REFB input receiver 0 (default) = not faulted 1 = faulted (REFB is not used) |
| | 0 | REFA fault | Faults REFA input receiver 0 (default) = not faulted 1 = faulted (REFA is not used) |

Table 149. Reference Input Monitor Bypass

| Address | Bits | Bit Name | Description |
|---------|-------|---------------------|--|
| 0x0A04 | [7:4] | Reserved | Default: 0x0 |
| | 3 | REFD monitor bypass | Bypasses REFD input receiver frequency monitor 0 (default) = REFD frequency monitor not bypassed 1 = REFD frequency monitor bypassed |
| | 2 | REFC monitor bypass | Bypasses REFC input receiver frequency monitor 0 (default) = REFC frequency monitor not bypassed 1 = REFC frequency monitor bypassed |
| | 1 | REFB monitor bypass | Bypasses REFB input receiver frequency monitor 0 (default) = REFB frequency monitor not bypassed 1 = REFB frequency monitor bypassed |
| | 0 | REFA monitor bypass | Bypasses REFA input receiver frequency monitor 0 (default) = REFA frequency monitor not bypassed 1 = REFA frequency monitor bypassed |

IRQ Clearing (Register 0x0A05 to Register 0x0A0E)

The IRQ clearing registers are identical in format to the IRQ monitor registers (Register 0x0D08 to Register 0x0D10). When set to Logic 1, an IRQ clearing bit resets the corresponding IRQ monitor bit, thereby cancelling the interrupt request for the indicated event. The IRQ clearing registers are autoclearing.

Table 150. IRQ Clearing of Groups

| Address | Bits | Bit Name | Description |
|---------|-------|----------------------|--|
| 0x0A05 | 7 | Clear watchdog timer | Clears watchdog timer alert |
| | [6:4] | Reserved | Reserved |
| | 3 | Clear DPLL_1 IRQs | Clears all IRQs associated with DPLL_1 |
| | 2 | Clear DPLL_0 IRQs | Clears all IRQs associated with DPLL_0 |
| | 1 | Clear common IRQs | Clears all IRQs associated with common IRQ group |
| | 0 | Clear all IRQs | Clears all IRQs |

Table 151. IRQ Clearing for SYSCLK and EEPROM

| Address | Bits | Bit Name | Description |
|---------|------|-----------------|--|
| 0x0A06 | 7 | Reserved | Reserved |
| | 6 | SYSCLK unlocked | Clears IRQ indicating a SYSCLK PLL state transition from locked to unlocked |
| | 5 | SYSCLK stable | Clears IRQ indicating that SYSCLK stability time has expired and that the SYSCLK PLL is considered to be stable. |
| | 4 | SYSCLK locked | Clears IRQ indicating a SYSCLK PLL state transition from unlocked to locked |
| | 3 | Watchdog timer | Clears IRQ indicating expiration of the watchdog timer |
| | 2 | Reserved | Reserved |
| | 1 | EEPROM fault | Clears IRQ indicating a fault during an EEPROM load or save operation |
| | 0 | EEPROM complete | Clears IRQ indicating successful completion of an EEPROM load or save operation |

Table 152. IRQ Clearing for Reference Inputs

| Address | Bits | Bit Name | Description |
|---------|------|--------------------|--|
| 0x0A07 | 7 | Reserved | Reserved |
| | 6 | REFB validated | Clears IRQ indicating that REFB has been validated |
| | 5 | REFB fault cleared | Clears IRQ indicating that REFB has been cleared of a previous fault |
| | 4 | REFB fault | Clears IRQ indicating that REFB has been faulted |
| | 3 | Reserved | Reserved |
| | 2 | REFA validated | Clears IRQ indicating that REFA has been validated |
| | 1 | REFA fault cleared | Clears IRQ indicating that REFA has been cleared of a previous fault |
| | 0 | REFA fault | Clears IRQ indicating that REFA has been faulted |
| 0x0A08 | 7 | Reserved | Reserved |
| | 6 | REFD validated | Clears IRQ indicating that REFD has been validated |
| | 5 | REFD fault cleared | Clears IRQ indicating that REFD has been cleared of a previous fault |
| | 4 | REFD fault | Clears IRQ indicating that REFD has been faulted |
| | 3 | Reserved | Reserved |
| | 2 | REFC validated | Clears IRQ indicating that REFC has been validated |
| | 1 | REFC fault cleared | Clears IRQ indicating that REFC has been cleared of a previous fault |
| | 0 | REFC fault | Clears IRQ indicating that REFC has been faulted |

Table 153. IRQ Clearing for Digital PLL0 (DPLL_0)

| Address | Bits | Bit Name | Description |
|---------|--------------------|---|--|
| 0x0A09 | 7 | Frequency unclamped | Clears IRQ indicating that DPLL_0 has exited a frequency clamped state |
| | 6 | Frequency clamped | Clears IRQ indicating that DPLL_0 has entered a frequency clamped state |
| | 5 | Phase slew unlimited | Clears IRQ indicating that DPLL_0 has exited a phase slew limited state |
| | 4 | Phase slew limited | Clears IRQ indicating that DPLL_0 has entered a phase slew limited state |
| | 3 | Frequency unlocked | Clears IRQ indicating that DPLL_0 has lost frequency lock |
| | 2 | Frequency locked | Clears IRQ indicating that DPLL_0 has acquired frequency lock |
| | 1 | Phase unlocked | Clears IRQ indicating that DPLL_0 has lost phase lock |
| | 0 | Phase locked | Clears IRQ indicating that DPLL_0 has acquired phase lock |
| 0x0A0A | 7 | DPLL_0 switching | Clears IRQ indicating that DPLL_0 is switching to a new reference |
| | 6 | DPLL_0 free run | Clears IRQ indicating that DPLL_0 has entered free run mode |
| | 5 | DPLL_0 holdover | Clears IRQ indicating that DPLL_0 has entered holdover mode |
| | 4 | History updated | Clears IRQ indicating that DPLL_0 has updated its tuning word history |
| | 3 | REFD activated | Clears IRQ indicating that DPLL_0 has activated REFD |
| | 2 | REFC activated | Clears IRQ indicating that DPLL_0 has activated REFC |
| | 1 | REFB activated | Clears IRQ indicating that DPLL_0 has activated REFB |
| | 0 | REFA activated | Clears IRQ indicating that DPLL_0 has activated REFA |
| 0x0A0B | [7:5] | Reserved | Reserved |
| | 4 | Sync distribution | Clears IRQ indicating a distribution sync event |
| | 3 | APLL_0 unlocked | Clears IRQ indicating that APLL_0 has been unlocked |
| | 2 | APLL_0 locked | Clears IRQ indicating that APLL_0 has been locked |
| | 1 | APLL_0 cal complete | Clears IRQ indicating that APLL_0 calibration complete |
| 0 | APLL_0 cal started | Clears IRQ indicating that APLL_0 calibration started | |

Table 154. IRQ Clearing for Digital PLL1 (DPLL_1)

| Address | Bits | Bit Name | Description |
|---------|-------|----------------------|--|
| 0x0A0C | 7 | Frequency unclamp | Clears IRQ indicating that DPLL_1 has exited a frequency clamped state |
| | 6 | Frequency clamp | Clears IRQ indicating that DPLL_1 has entered a frequency clamped state |
| | 5 | Phase slew unlimited | Clears IRQ indicating that DPLL_1 has exited a phase slew limited state |
| | 4 | Phase slew limited | Clears IRQ indicating that DPLL_1 has entered a phase slew limited state |
| | 3 | Frequency unlocked | Clears IRQ indicating that DPLL_1 has lost frequency lock |
| | 2 | Frequency locked | Clears IRQ indicating that DPLL_1 has acquired frequency lock |
| | 1 | Phase unlocked | Clears IRQ indicating that DPLL_1 has lost phase lock |
| | 0 | Phase locked | Clears IRQ indicating that DPLL_1 has acquired phase lock |
| 0x0A0D | 7 | DPLL_1 switching | Clears IRQ indicating that DPLL_1 is switching to a new reference |
| | 6 | DPLL_1 free run | Clears IRQ indicating that DPLL_1 has entered free run mode |
| | 5 | DPLL_1 holdover | Clears IRQ indicating that DPLL_1 has entered holdover mode |
| | 4 | History updated | Clears IRQ indicating that DPLL_1 has updated its tuning word history |
| | 3 | REFD activated | Clears IRQ indicating that DPLL_1 has activated REFD |
| | 2 | REFC activated | Clears IRQ indicating that DPLL_1 has activated REFC |
| | 1 | REFB activated | Clears IRQ indicating that DPLL_1 has activated REFB |
| | 0 | REFA activated | Clears IRQ indicating that DPLL_1 has activated REFA |
| 0x0A0E | [7:5] | Reserved | Reserved |
| | 4 | Sync distribution | Clears IRQ indicating a distribution sync event |
| | 3 | APLL_1 unlocked | Clears IRQ indicating that APLL_1 has been unlocked |
| | 2 | APLL_1 locked | Clears IRQ indicating that APLL_1 has been locked |
| | 1 | APLL_1 cal complete | Clears IRQ indicating that APLL_1 calibration complete |
| | 0 | APLL_1 cal started | Clears IRQ indicating that APLL_1 calibration started |

PLL_0 OPERATIONAL CONTROLS (REGISTER 0x0A20 TO REGISTER 0x0A24)

Table 155. PLL_0 Sync and Calibration

| Address | Bits | Bit Name | Description |
|---------|-------|--------------------------------------|---|
| 0x0A20 | [7:3] | Reserved | Default: 0x0 |
| | 2 | APLL_0 soft sync | Setting this bit initiates synchronization of the clock distribution output. Default: 0b. Nonmasked outputs stall when value is 1; restart is initialized on a 1-to-0 transition. |
| | 1 | APLL_0 calibrate (not self-clearing) | 1 = initiates VCO calibration (calibration occurs on a 0-to-1 transition). 0 (default) = does nothing. This bit is not an autoclearing bit. |
| | 0 | PLL_0 power-down | Places DPLL_0, APLL_0, and PLL_0 clock in deep sleep mode. Default: the device is not powered down. |

Table 156. PLL_0 Output Disable

| Address | Bits | Bit Name | Description |
|---------|-------|--------------------------|--|
| 0x0A21 | [7:4] | Reserved | Default 0x0 |
| | 3 | OUT0B disable | Setting this bit puts the only OUT0B driver into power-down. Default: 0b. Channel synchronization is maintained, but runt pulses may be generated. |
| | 2 | OUT0A disable | Setting this bit puts the only OUT0A driver into power-down. Default: 0b. Channel synchronization is maintained, but runt pulses may be generated. |
| | 1 | OUT0B channel power-down | Setting this bit puts the OUT0B divider and driver into power-down. Default: 0b. This mode saves the most power, but runt pulses may be generated during exit. |
| | 0 | OUT0A channel power-down | Setting this bit puts the OUT0A divider and driver into power-down. Default: 0b. This mode saves the most power, but runt pulses may be generated during exit. |

Table 157. DPLL_0 User Mode

| Address | Bits | Bit Name | Description | |
|---------|---|---|--|---------------------------------|
| 0x0A22 | 7 | Reserved | Default: 0b | |
| | [6:5] | DPLL_0 manual reference | Input reference when user selection mode = 00, 01, 10, or 11 00 (default) = Input Reference A 01 = Input Reference B 10 = Input Reference C 11 = Input Reference D | |
| | [4:2] | DPLL_0 switching mode | Selects the operating mode of the reference switching state machine | |
| | | | Reference Switchover Mode, Bits[2:0] | Reference Selection Mode |
| | | | 000 | Automatic revertive mode |
| 001 | | | Automatic nonrevertive mode | |
| 010 | | | Manual reference select mode (with automatic fallback) | |
| 011 | Manual reference select mode (with automatic holdover fallback) | | | |
| 100 | Manual reference select mode (without holdover fallback) | | | |
| 101 | Not used | | | |
| 110 | Not used | | | |
| 111 | Not used | | | |
| 1 | DPLL_0 user holdover | Forces DPLL_0 into holdover mode 0 (default) = normal operation 1 (default) = DPLL_0 is forced into holdover mode until this bit is cleared | | |
| 0 | DPLL_0 user free run | Forces DPLL_0 into free run mode 0 (default) = normal operation 1 = DPLL_0 is forced into free run mode until this bit is cleared | | |

Table 158. DPLL_0 Reset

| Address | Bits | Bit Name | Description |
|---------|-------|--------------------------|---|
| 0x0A23 | [7:3] | Reserved | Default: 00000b. |
| | 2 | Reset DPLL_0 loop filter | Setting this bit clears the digital loop filter (intended as a debug tool). |
| | 1 | Reset DPLL_0 TW history | Setting this bit resets the tuning word history logic (part of holdover functionality). |
| | 0 | Reset DPLL_0 autosync | Setting this bit resets the automatic synchronization logic (see Register 0x0425). |

Table 159. DPLL_0 Phase

| Address | Bits | Bit Name | Description |
|---------|-------|-------------------------------|---|
| 0x0A24 | [7:3] | Reserved | Default: 00000b. |
| | 2 | DPLL_0 reset phase offset | Resets the incremental phase offset to zero. This is an autoclearing bit. |
| | 1 | DPLL_0 decrement phase offset | Decrements the incremental phase offset by the amount specified in the incremental phase lock offset step size registers (Register 0x0412 and Register 0x0413). This is an autoclearing bit. |
| | 0 | DPLL_0 increment phase offset | Increments the incremental phase offset by the amount specified in the incremental phase lock offset step size registers (Register 0x0412 and Register 0x0413). This is an autoclearing bit. |

PLL_1 OPERATIONAL CONTROLS (REGISTER 0x0A40 TO REGISTER 0x0A44)**Table 160. PLL_1 Sync and Calibration**

| Address | Bits | Bit Name | Description |
|---------|-------|--------------------------------------|---|
| 0x0A40 | [7:3] | Reserved | Default: 0x0. |
| | 2 | APLL_1 soft sync | Setting this bit initiates synchronization of the clock distribution output. Default: 0b. Nonmasked outputs stall when value is 1; restart is initialized on a 1-to-0 transition. |
| | 1 | APLL_1 calibrate (not self-clearing) | 1 = initiates VCO calibration (calibration occurs on a 0-to-1 transition). 0 (default) = does nothing. This bit is not autoclearing. |
| | 0 | PLL_1 power-down | Places DPLL_1, APLL_1, and PLL_1 clock in deep sleep mode. Default: the device is not powered down. |

Table 161. PLL_1 Output Disable

| Address | Bits | Bit Name | Description |
|---------|-------|--------------------------|---|
| 0x0A41 | [7:4] | Reserved | Default 0x0. |
| | 3 | OUT1B disable | Setting this bit puts the only OUT1B driver into power-down. Default: 0b. Channel synchronization is maintained, but runt pulses may be generated. |
| | 2 | OUT1A disable | Setting this bit puts the only OUT1A driver into power-down. Default: 0b. Channel synchronization is maintained, but runt pulses may be generated. |
| | 1 | OUT1B channel power-down | Setting this bit puts the OUT1B divider and driver into power-down. Default: 0b. This mode saves the most power, but runt pulses may be generated during exit. |
| | 0 | OUT1A channel power-down | Setting this bit puts the OUT1A divider and driver into power-down. Default: 0b. This mode saves the most power, but runt pulses may be generated during exit. |

Table 162. DPLL_1 User Mode

| Address | Bits | Bit Name | Description | |
|---------|----------------------|---|---|---------------------------------|
| 0x0A42 | 7 | Reserved | Default: 0b. | |
| | [6:5] | DPLL_1 manual reference | Input reference when user selection mode = 00, 01, 10, or 11. 00 (default) = Input Reference A. 01 = Input Reference B. 10 = Input Reference C. 11 = Input Reference D. | |
| | [4:2] | DPLL_1 switching mode | Selects the operating mode of the reference switching state machine. | |
| | | | Reference Switchover Mode, Bits[2:0] | Reference Selection Mode |
| 000 | | | Automatic revertive mode | |
| 001 | | | Automatic nonrevertive mode | |
| 010 | | | Manual reference select mode (with automatic fallback) | |
| 011 | | | Manual reference select mode (with automatic holdover fallback) | |
| 100 | | | Manual reference select mode (without holdover fallback) | |
| 101 | | | Not used | |
| 110 | Not used | | | |
| 111 | Not used | | | |
| 1 | DPLL_1 user holdover | This bit forces DPLL_1 into holdover mode. 0 (default) = normal operation. 1 (default) = DPLL_1 is forced into holdover mode until this bit is cleared. | | |
| 0 | DPLL_1 user free run | This bit forces DPLL_1 into free run mode. 0 (default) = normal operation. 1 = DPLL_1 is forced into free run mode until this bit is cleared. | | |

Table 163. DPLL_1 Reset

| Address | Bits | Bit Name | Description |
|---------|-------|--------------------------|---|
| 0x0A43 | [7:3] | Reserved | Default: 00000b. |
| | 2 | Reset DPLL_1 loop filter | Setting this bit clears the digital loop filter (intended as a debug tool). |
| | 1 | Reset DPLL_1 TW history | Setting this bit resets the tuning word history logic (part of holdover functionality). |
| | 0 | Reset DPLL_1 autosync | Setting this bit resets the automatic synchronization logic (see Register 0x0525). |

Table 164. DPLL_1 Phase

| Address | Bits | Bit Name | Description |
|---------|-------|-------------------------------|---|
| 0x0A44 | [7:3] | Reserved | Default: 00000b. |
| | 2 | DPLL_1 reset phase offset | Resets the incremental phase offset to zero. This is an autoclearing bit. |
| | 1 | DPLL_1 decrement phase offset | Decrements the incremental phase offset by the amount specified in the incremental phase lock offset step size register (Register 0x0512 to Register 0x0513). This is an autoclearing bit. |
| | 0 | DPLL_1 increment phase offset | Increments the incremental phase offset by the amount specified in the incremental phase lock offset step size register (Register 0x0512 and Register 0x0513). This is an autoclearing bit. |

STATUS READBACK (REGISTER 0x0D00 TO REGISTER 0x0D05)

All bits in Register 0x0D00 to Register 0x0D05 are read only. To report the latest status, these bits require an IO_UPDATE (Register 0x0005 = 0x01) immediately before being read.

Table 165. EEPROM Status

| Address | Bits | Bit Name | Description |
|---------|-------|------------------|--|
| 0x0D00 | [7:3] | Reserved | Default: 00000b. |
| | 2 | Fault detected | An error occurred while saving data to or loading data from the EEPROM. |
| | 1 | Load in progress | The control logic sets this bit while data is being read from the EEPROM. |
| | 0 | Save in progress | The control logic sets this bit while data is being written to the EEPROM. |

Table 166. SYSCLK Status

| Address | Bits | Bit Name | Description |
|---------|-------|---------------------|---|
| 0x0D01 | [7:4] | Reserved | Default: 0x0. |
| | 3 | PLL_1 all locked | Indicates the status of the system clock, APLL_1, and DPLL_1. 0 = system clock or APLL_1 or DPLL_1 is unlocked. 1 = all three PLLs (system clock, APLL_1, and DPLL_1) are locked. |
| | 2 | PLL_0 all locked | Indicates the status of the system clock, APLL_0, and DPLL_0. 0 = system clock or APLL_0 or DPLL_0 is unlocked. 1 = all three PLLs (system clock, APLL_0, and DPLL_0) are locked. |
| | 1 | System clock stable | The control logic sets this bit when the device considers the system clock to be stable (see the System Clock Stability Timer section). |
| | 0 | SYSCLK lock detect | Indicates the status of the system clock PLL. 0 = unlocked. 1 = locked. |

Table 167. Status of Reference Inputs

| Address | Bits | Bit Name | Description |
|---------|-------|--------------------|---|
| 0x0D02 | [7:6] | Reserved | Default: 00b. |
| | 5 | DPLL_1 REFA active | This bit is 1 if DPLL_1 is either locked to or attempting to lock to REFA. |
| | 4 | DPLL_0 REFA active | This bit is 1 if DPLL_0 is either locked to or attempting to lock to REFA. |
| | 3 | REFA valid | This bit is 1 if the REFA frequency is within the programmed limits. |
| | 2 | REFA fault | This bit is 1 if the REFA frequency is outside of the programmed limits. |
| | 1 | REFA fast | This bit is 1 if the REFA frequency is higher than allowed by its profile settings. |
| | 0 | REFA slow | This bit is 1 if the REFA frequency is lower than allowed by its profile settings. |
| 0x0D03 | [7:6] | Reserved | Default: 00b. |
| | 5 | DPLL_1 REFB active | This bit is 1 if DPLL_1 is either locked to or attempting to lock to REFB. |
| | 4 | DPLL_0 REFB active | This bit is 1 if DPLL_0 is either locked to or attempting to lock to REFB. |
| | 3 | REFB valid | This bit is 1 if the REFB frequency is within the programmed limits. |
| | 2 | REFB fault | This bit is 1 if the REFB frequency is outside of the programmed limits. |
| | 1 | REFB fast | This bit is 1 if the REFB frequency is higher than allowed by its profile settings. |
| | 0 | REFB slow | This bit is 1 if the REFB frequency is lower than allowed by its profile settings. |
| 0x0D04 | [7:6] | Reserved | Default: 00b. |
| | 5 | DPLL_1 REFC active | This bit is 1 if DPLL_1 is either locked to or attempting to lock to REFC. |
| | 4 | DPLL_0 REFC active | This bit is 1 if DPLL_0 is either locked to or attempting to lock to REFC. |
| | 3 | REFC valid | This bit is 1 if the REFC frequency is within the programmed limits. |
| | 2 | REFC fault | This bit is 1 if the REFC frequency is outside of the programmed limits. |
| | 1 | REFC fast | This bit is 1 if the REFC frequency is higher than allowed by its profile settings. |
| | 0 | REFC slow | This bit is 1 if the REFC frequency is lower than allowed by its profile settings. |
| 0x0D05 | [7:6] | Reserved | Default: 00b. |
| | 5 | DPLL_1 REFD active | This bit is 1 if DPLL_1 is either locked to or attempting to lock to REFD. |
| | 4 | DPLL_0 REFD active | This bit is 1 if DPLL_0 is either locked to or attempting to lock to REFD. |
| | 3 | REFD valid | This bit is 1 if the REFD frequency is within the programmed limits. |
| | 2 | REFD fault | This bit is 1 if the REFD frequency is outside of the programmed limits. |
| | 1 | REFD fast | This bit is 1 if the REFD frequency is higher than allowed by its profile settings. |
| | 0 | REFD slow | This bit is 1 if the REFD frequency is lower than allowed by its profile settings. |

IRQ MONITOR (REGISTER 0x0D08 TO REGISTER 0x0D10)

If not masked via the IRQ mask registers (Register 0x010A to Register 0x0112), the appropriate IRQ monitor bit is set to Logic 1 when the indicated event occurs. These bits can be cleared only by a device reset, or by setting the clear all IRQs bit in Register 0x0A05, or by setting the IRQ clearing registers (Register 0x0A05 to Register 0x0A0E).

Table 168. IRQ for Common Functions

| Address | Bits | Bit Name | Description |
|---------|------|-----------------|--|
| 0x0D08 | 7 | Reserved | Reserved |
| | 6 | SYSCLK unlocked | IRQ indicating a SYSCLK PLL state transition from locked to unlocked |
| | 5 | SYSCLK stable | IRQ indicating that SYSCLK stability time has expired and that the SYSCLK PLL is considered to be stable |
| | 4 | SYSCLK locked | IRQ indicating a SYSCLK PLL state transition from unlocked to locked |
| | 3 | Watchdog timer | IRQ indicating expiration of the watchdog timer |
| | 2 | Reserved | Reserved |
| | 1 | EEPROM fault | IRQ indicating a fault during an EEPROM load or save operation |
| | 0 | EEPROM complete | IRQ indicating successful completion of an EEPROM load or save operation |

| Address | Bits | Bit Name | Description |
|---------|------|--------------------|---|
| 0x0D09 | 7 | Reserved | Reserved |
| | 6 | REFB validated | IRQ indicating that REFB has been validated |
| | 5 | REFB fault cleared | IRQ indicating that REFB has been cleared of a previous fault |
| | 4 | REFB fault | IRQ indicating that REFB has been faulted |
| | 3 | Reserved | Reserved |
| | 2 | REFA validated | IRQ indicating that REFA has been validated |
| | 1 | REFA fault cleared | IRQ indicating that REFA has been cleared of a previous fault |
| | 0 | REFA fault | IRQ indicating that REFA has been faulted |
| 0x0D0A | 7 | Reserved | Reserved |
| | 6 | REFD validated | IRQ indicating that REFD has been validated |
| | 5 | REFD fault cleared | IRQ indicating that REFD has been cleared of a previous fault |
| | 4 | REFD fault | IRQ indicating that REFD has been faulted |
| | 3 | Reserved | Reserved |
| | 2 | REFC validated | IRQ indicating that REFC has been validated |
| | 1 | REFC fault cleared | IRQ indicating that REFC has been cleared of a previous fault |
| | 0 | REFC fault | IRQ indicating that REFC has been faulted |

Table 169. IRQ Monitor for Digital PLL0 (DPLL_0)

| Address | Bits | Bit Name | Description |
|---------|--------------------|--|---|
| 0x0D0B | 7 | Frequency unclamp | IRQ indicating that DPLL_0 has exited a frequency clamped state |
| | 6 | Frequency clamp | IRQ indicating that DPLL_0 has entered a frequency clamped state |
| | 5 | Phase slew unlimited | IRQ indicating that DPLL_0 has exited a phase slew limited state |
| | 4 | Phase slew limited | IRQ indicating that DPLL_0 has entered a phase slew limited state |
| | 3 | Frequency unlocked | IRQ indicating that DPLL_0 has lost frequency lock |
| | 2 | Frequency locked | IRQ indicating that DPLL_0 has acquired frequency lock |
| | 1 | Phase unlocked | IRQ indicating that DPLL_0 has lost phase lock |
| | 0 | Phase locked | IRQ indicating that DPLL_0 has acquired phase lock |
| 0x0D0C | 7 | DPLL_0 switching | IRQ indicating that DPLL_0 is switching to a new reference |
| | 6 | DPLL_0 free run | IRQ indicating that DPLL_0 has entered free run mode |
| | 5 | DPLL_0 holdover | IRQ indicating that DPLL_0 has entered holdover mode |
| | 4 | History updated | IRQ indicating that DPLL_0 has updated its tuning word history |
| | 3 | REFD activated | IRQ indicating that DPLL_0 has activated REFD |
| | 2 | REFC activated | IRQ indicating that DPLL_0 has activated REFC |
| | 1 | REFB activated | IRQ indicating that DPLL_0 has activated REFB |
| | 0 | REFA activated | IRQ indicating that DPLL_0 has activated REFA |
| 0x0D0D | [7:5] | Reserved | Reserved |
| | 4 | Sync distribution | IRQ indicating a distribution sync event |
| | 3 | APLL_0 unlocked | IRQ indicating that APLL_0 has been unlocked |
| | 2 | APLL_0 locked | IRQ indicating that APLL_0 has been locked |
| | 1 | APLL_0 cal ended | IRQ indicating that APLL_0 calibration complete |
| 0 | APLL_0 cal started | IRQ indicating that APLL_0 calibration started | |

Table 170. IRQ Monitor for Digital PLL1 (DPLL_1)

| Address | Bits | Bit Name | Description |
|---------|-------|----------------------|---|
| 0x0D0E | 7 | Frequency unclamped | IRQ indicating that DPLL_1 has exited a frequency clamped state |
| | 6 | Frequency clamped | IRQ indicating that DPLL_1 has entered a frequency clamped state |
| | 5 | Phase slew unlimited | IRQ indicating that DPLL_1 has exited a phase slew limited state |
| | 4 | Phase slew limited | IRQ indicating that DPLL_1 has entered a phase slew limited state |
| | 3 | Frequency unlocked | IRQ indicating that DPLL_1 has lost frequency lock |
| | 2 | Frequency locked | IRQ indicating that DPLL_1 has acquired frequency lock |
| | 1 | Phase unlocked | IRQ indicating that DPLL_1 has lost phase lock |
| | 0 | Phase locked | IRQ indicating that DPLL_1 has acquired phase lock |
| 0x0D0F | 7 | DPLL_1 switching | IRQ indicating that DPLL_1 is switching to a new reference |
| | 6 | DPLL_1 free run | IRQ indicating that DPLL_1 has entered free run mode |
| | 5 | DPLL_1 holdover | IRQ indicating that DPLL_1 has entered holdover mode |
| | 4 | History updated | IRQ indicating that DPLL_1 has updated its tuning word history |
| | 3 | REFD activated | IRQ indicating that DPLL_1 has activated REFD |
| | 2 | REFC activated | IRQ indicating that DPLL_1 has activated REFC |
| | 1 | REFB activated | IRQ indicating that DPLL_1 has activated REFB |
| | 0 | REFA activated | IRQ indicating that DPLL_1 has activated REFA |
| 0x0D10 | [7:5] | Reserved | Reserved |
| | 4 | Sync distribution | IRQ indicating a distribution sync event |
| | 3 | APLL_1 unlocked | IRQ indicating that APLL_1 has been unlocked |
| | 2 | APLL_1 locked | IRQ indicating that APLL_1 has been locked |
| | 1 | APLL_1 cal ended | IRQ indicating that APLL_1 calibration complete |
| | 0 | APLL_1 cal started | IRQ indicating that APLL_1 calibration started |

PLL_0 READ-ONLY STATUS (REGISTER 0x0D20 TO REGISTER 0x0D2A)

All bits in Register 0x0D20 to Register 0x0D2A are read only. To report the latest status, these bits require an IO_UPDATE (Register 0x0005 = 0x01) immediately before being read.

Table 171. PLL_0 Lock Status

| Address | Bits | Bit Name | Description |
|---------|-------|------------------------|---|
| 0x0D20 | [7:5] | Reserved | Default: 000b |
| | 4 | APLL_0 cal in progress | The control logic holds this bit set while the calibration of the APLL_0 VCO is in progress. |
| | 3 | APLL_0 locked | Indicates the status of APLL_0. 0 = unlocked. 1 = locked. |
| | 2 | DPLL_0 frequency lock | Indicates the frequency lock status of DPLL_0. 0 = unlocked. 1 = locked. |
| | 1 | DPLL_0 phase lock | Indicates the phase lock status of DPLL_0. 0 = unlocked. 1 = locked. |
| | 0 | PLL_0 all locked | Indicates the status of the system clock, APLL_0, and DPLL_0. 0 = system clock PLL or APLL_0 or DPLL_0 is unlocked. 1 = all three PLLs (system clock PLL, APLL_0, and DPLL_0) are locked. |

Table 172. DPLL_0 Loop State

| Address | Bits | Bit Name | Description |
|---------|-------|---------------------------|---|
| 0x0D21 | [7:5] | Reserved | Default: 000b. |
| | [4:3] | DPLL_0 active ref | Indicates the reference input that DPLL_0 is using. 00 = DPLL_0 has selected REFA. 01 = DPLL_0 has selected REFB. 10 = DPLL_0 has selected REFC. 11 = DPLL_0 has selected REFD. |
| | 2 | DPLL_0 switching | Indicates that DPLL_0 is switching input references. 0 = DPLL is not switching. 1 = DPLL is switching input references. |
| | 1 | DPLL_0 holdover | Indicates that DPLL_0 is in holdover mode. 0 = not in holdover. 1 = in holdover mode. |
| | 0 | DPLL_0 free run | Indicates that DPLL_0 is in free run mode. 0 = not in free run mode. 1 = in free run mode. |
| 0x0D22 | [7:3] | Reserved | Default: 00000b. |
| | 2 | DPLL_0 phase slew limited | The control logic sets this bit when DPLL_0 is phase-slew limited. |
| | 1 | DPLL_0 frequency clamped | The control logic sets this bit when DPLL_0 is frequency clamped. |
| | 0 | DPLL_0 history available | The control logic sets this bit when the tuning word history of DPLL_0 is available. (See Register 0x0D23 to Register 0x0D26 for the tuning word.) |

Table 173. DPLL_0 Holdover History

| Address | Bits | Bit Name | Description |
|---------|-------|-----------------------------|---|
| 0x0D23 | [7:0] | DPLL_0 tuning word readback | DPLL_0 tuning word readback bits, Bits[7:0]. This group of registers contains the averaged digital PLL tuning word used when the DPLL enters holdover. Setting the history accumulation timer to its minimal value allows the user to use these registers for a readback of the most recent DPLL tuning word without averaging. |
| 0x0D24 | [7:0] | | DPLL_0 tuning word readback, Bits[15:8]. |
| 0x0D25 | [7:0] | | DPLL_0 tuning word readback, Bits[23:9]. |
| 0x0D26 | [7:6] | | Reserved. |
| | [5:0] | | DPLL_0 tuning word readback, Bits[29:24]. |

Table 174. DPLL_0 Phase Lock and Frequency Lock Bucket Levels

| Address | Bits | Bit Name | Description |
|---------|-------|---|---|
| 0x0D27 | [7:0] | DPLL_0 phase lock detect bucket level | Read-only digital PLL lock detect bucket level, Bits[7:0]; see the DPLL Frequency Lock Detector section for details. |
| 0x0D28 | [7:4] | Reserved | Reserved. |
| | [3:0] | DPLL_0 phase lock detect bucket level | Read-only digital PLL lock detect bucket level, Bits[11:8]; see the DPLL Frequency Lock Detector section for details. |
| 0x0D29 | [7:0] | DPLL_0 frequency lock detect bucket level | Read-only digital PLL lock detect bucket level, Bits[7:0]; see the DPLL Phase Lock Detector section for details. |
| 0x0D2A | [7:4] | Reserved | Reserved. |
| | [3:0] | DPLL_0 frequency lock detect bucket level | Read-only digital PLL lock detect bucket level, Bits[11:8]; see the DPLL Phase Lock Detector section for details. |

PLL_1 READ-ONLY STATUS (REGISTER 0x0D40 TO REGISTER 0x0D4A)

All bits in Register 0x0D40 to Register 0x0D4A are read only. To report the latest status, these bits require an IO_UPDATE (Register 0x0005 = 0x01) immediately before being read.

Table 175. PLL_1 Lock Status

| Address | Bits | Bit Name | Description |
|---------|-------|------------------------|---|
| 0x0D40 | [7:5] | Reserved | Default: 000b |
| | 4 | APLL_1 cal in progress | The control logic holds this bit set while the calibration of the APLL_1 VCO is in progress. |
| | 3 | APLL_1 locked | Indicates the status of APLL_1. 0 = unlocked. 1 = locked. |
| | 2 | DPLL_1 frequency lock | Indicates the frequency lock status of DPLL_1. 0 = unlocked. 1 = locked. |
| | 1 | DPLL_1 phase lock | Indicates the phase lock status of DPLL_1. 0 = unlocked. 1 = locked. |
| | 0 | PLL_1 all locked | Indicates the status of the system clock, APLL_1, and DPLL_1. 0 = system clock PLL or APLL_1 or DPLL_1 is unlocked. 1 = all three PLLs (system clock PLL, APLL_1, and DPLL_1) are locked. |

Table 176. DPLL_1 Loop State

| Address | Bits | Bit Name | Description |
|---------|-------|---------------------------|---|
| 0x0D41 | [7:5] | Reserved | Default: 000b. |
| | [4:3] | DPLL_1 active ref | Indicates the reference input that DPLL_0 is using. 00 = DPLL_1 has selected REFA. 01 = DPLL_1 has selected REFB. 10 = DPLL_1 has selected REFC. 11 = DPLL_1 has selected REFD. |
| | 2 | DPLL_1 switching | Indicates that DPLL_1 is switching input references. 0 = DPLL is not switching. 1 = DPLL is switching input references. |
| | 1 | DPLL_1 holdover | Indicates that DPLL_1 is in holdover mode. 0 = not in holdover mode. 1 = in holdover mode. |
| | 0 | DPLL_1 free run | Indicates that DPLL_1 is in free run mode. 0 = not in free run mode. 1 = in free run mode. |
| 0x0D42 | [7:3] | Reserved | Default: 00000b. |
| | 2 | DPLL_1 phase slew limited | The control logic sets this bit when DPLL_1 is phase-slew limited. |
| | 1 | DPLL_1 frequency clamped | The control logic sets this bit when DPLL_1 is frequency clamped. |
| | 0 | DPLL_1 history updated | The control logic sets this bit when the tuning word history of DPLL_1 is available. (See Register 0x0D43 to Register 0x0D46 for the tuning word.) |

Table 177. DPLL_1 Holdover History

| Address | Bits | Bit Name | Description |
|---------|-------|-----------------------------|---|
| 0x0D43 | [7:0] | DPLL_0 tuning word readback | DPLL_1 tuning word readback bits, Bits[7:0]. This group of registers contains the averaged digital PLL tuning word used when the DPLL enters holdover. Setting the history accumulation timer to its minimal value allows the user to use these registers for a readback of the most recent DPLL tuning word without averaging. |
| 0x0D44 | [7:0] | | DPLL_1 tuning word readback, Bits[15:8]. |
| 0x0D45 | [7:0] | | DPLL_1 tuning word readback, Bits[23:9]. |
| 0x0D46 | [7:6] | | Reserved. |
| | [5:0] | | DPLL_1 tuning word readback, Bits[29:24]. |

Table 178. DPLL_1 Phase Lock and Frequency Lock Bucket Levels

| Address | Bits | Bit Name | Description |
|---------|-------|---------------------------------|---|
| 0x0D47 | [7:0] | DPLL_1 phase lock detect bucket | Read-only DPLL_1 lock detect bucket level, Bits[7:0]; see the DPLL Frequency Lock Detector section. |
| 0x0D48 | [7:4] | Reserved | Reserved. |
| | [3:0] | DPLL_1 phase lock detect bucket | Read-only DPLL_1 lock detect bucket level, Bits[1:8]; see the DPLL Frequency Lock Detector section. |
| 0x0D49 | [7:0] | Frequency tub | Read-only DPLL_1 frequency lock detect bucket level, Bits[7:0]; see the DPLL Phase Lock Detector section. |
| 0x0D4A | [7:4] | Reserved | Reserved. |
| | [3:0] | Frequency tub | Read-only DPLL_1 frequency lock detect bucket level, Bits[1:8]; see the DPLL Phase Lock Detector section. |

EEPROM CONTROL (REGISTER 0x0E00 TO REGISTER 0x0E03)

Table 179. EEPROM Control

| Address | Bits | Bit Name | Description |
|---------|-------|-------------------|---|
| 0x0E00 | [7:1] | Reserved | Reserved |
| | 0 | Write enable | EEPROM write enable/protect. 0 (default) = EEPROM write protected 1 = EEPROM write enabled |
| 0x0E01 | [7:4] | Reserved | Reserved |
| | [3:0] | Conditional value | When set to a nonzero value, it establishes the condition for EEPROM downloads. The default value is 0. |
| 0x0E02 | [7:1] | Reserved | Reserved |
| | 0 | Save to EEPROM | Uploads data to the EEPROM (see the EEPROM Storage Sequence (Register 0x0E10 to Register 0x0E3C) section for more information). Once an EEPROM save/load transfer is complete, the user should wait a minimum of 10 μ s before starting the next EEPROM save/load transfer. |
| 0x0E03 | [7:2] | Reserved | Reserved |
| | 1 | Load from EPROM | Downloads data from the EEPROM. Once an EEPROM save/load transfer is complete, the user should wait a minimum of 10 μ s before starting the next EEPROM save/load transfer. |
| | 0 | Reserved | Reserved |

EEPROM STORAGE SEQUENCE (REGISTER 0x0E10 TO REGISTER 0x0E3C)

The default settings of Register 0x0E10 to Register 0x0E33 contain the default EEPROM instruction sequence. The tables in this section provide descriptions of the register defaults, assuming that the controller has been instructed to carry out an EEPROM storage sequence in which all of the registers are stored and loaded by the EEPROM.

Table 180. EEPROM Storage Sequence for M Pin Settings and IRQ Masks

| Address | Bits | Bit Name | Description |
|---------|-------|----------------------|--|
| 0x0E10 | [7:0] | User free run | The default value of this register is 0x98, which the controller interprets as a user free run command for both PLLs. The controller stores 0x98 in the EEPROM and increments the EEPROM address pointer. |
| 0x0E11 | [7:0] | User scratchpad | The default value of this register is 0x01, which is a data instruction. Its decimal value is 1, which tells the controller to transfer two bytes of data (1 + 1), beginning at the address specified by the next two bytes. The controller stores 0x01 in the EEPROM and increments the EEPROM address pointer. |
| 0x0E12 | [7:0] | | The default value of these two registers is 0x000E. Because the previous register contains a data instruction, these two registers define a starting address (in this case, 0x000E). The controller stores 0x000E in the EEPROM and increments the EEPROM pointer by 2. It then transfers two bytes from the register map (beginning at Address 0x000E) to the EEPROM and increments the EEPROM address pointer by 3 (two data bytes and one checksum byte). The two bytes transferred correspond to the user scratchpad in the register map. |
| 0x0E13 | [7:0] | | |
| 0x0E14 | [7:0] | M pins and IRQ masks | The default value of this register is 0x12, which the controller interprets as a data instruction. Its decimal value is 18, which tells the controller to transfer 19 bytes of data (18 + 1), beginning at the address specified by the next two bytes. The controller stores 0x12 in the EEPROM and increments the EEPROM address pointer. |
| 0x0E15 | [7:0] | | The default value of these two registers is 0x0100. Because the previous register contains a data instruction, these two registers define a starting address (in this case, 0x0100). The controller stores 0x0100 in the EEPROM and increments the EEPROM pointer by 2. It then transfers 19 bytes from the register map (beginning at Address 0x0100) to the EEPROM and increments the EEPROM address pointer by 20 (19 data bytes and one checksum byte). The 19 bytes transferred correspond to the M pin and IRQ settings in the register map. |
| 0x0E16 | [7:0] | | |

Table 181. EEPROM Storage Sequence for System Clock Settings

| Address | Bits | Bit Name | Description |
|---------|-------|--------------|---|
| 0x0E17 | [7:0] | System clock | The default value of this register is 0x07, which is a data instruction. Its decimal value is 7, which tells the controller to transfer eight bytes of data (7 + 1), beginning at the address specified by the next two bytes. The controller stores 0x07 in the EEPROM and increments the EEPROM address pointer. |
| 0x0E18 | [7:0] | | The default value of these two registers is 0x0200. Because the previous register contains a data instruction, these two registers define a starting address (in this case, 0x0200). The controller stores 0x0200 in the EEPROM and increments the EEPROM pointer by 2. It then transfers eight bytes from the register map (beginning at Address 0x0200) to the EEPROM and increments the EEPROM address pointer by 9 (eight data bytes and one checksum byte). The eight bytes transferred correspond to the system clock settings in the register map. |
| 0x0E19 | [7:0] | | |
| 0x0E1A | [7:0] | IO_UPDATE | The default value of this register is 0x80, which the controller interprets as an IO_UPDATE instruction. The controller stores 0x80 in the EEPROM and increments the EEPROM address pointer. |

Table 182. EEPROM Storage Sequence for Reference Input Settings

| Address | Bits | Bit Name | Description |
|---------|-------|----------|---|
| 0x0E1B | [7:0] | REFA | The default value of this register is 0x1A, which is a data instruction. Its decimal value is 26, which tells the controller to transfer 27 bytes of data (26 + 1), beginning at the address specified by the next two bytes. The controller stores 0x1A in the EEPROM and increments the EEPROM address pointer. |
| 0x0E1C | [7:0] | | The default value of these two registers is 0x0300. Because the previous register contains a data instruction, these two registers define a starting address (in this case, 0x0300). The controller stores 0x0300 in the EEPROM and increments the EEPROM pointer by 2. It then transfers 27 bytes from the register map (beginning at Address 0x0300) to the EEPROM and increments the EEPROM address pointer by 28 (27 data bytes and one checksum byte). The 27 bytes transferred correspond to the REFA parameters in the register map. |
| 0x0E1D | [7:0] | | |
| 0x0E1E | [7:0] | REFB | The default value of this register is 0x1A, which is a data instruction. Its decimal value is 26, which tells the controller to transfer 27 bytes of data (26 + 1), beginning at the address specified by the next two bytes. The controller stores 0x1A in the EEPROM and increments the EEPROM address pointer. |
| 0x0E1F | [7:0] | | The default value of these two registers is 0x0320. Because the previous register contains a data instruction, these two registers define a starting address (in this case, 0x0320). The controller stores 0x0320 in the EEPROM and increments the EEPROM pointer by 2. It then transfers 27 bytes from the register map (beginning at Address 0x0320) to the EEPROM and increments the EEPROM address pointer by 28 (27 data bytes and one checksum byte). The 27 bytes transferred correspond to the REFB parameters in the register map. |
| 0x0E20 | [7:0] | | |
| 0x0E21 | [7:0] | REFC | The default value of this register is 0x1A, which is a data instruction. Its decimal value is 26, which tells the controller to transfer 27 bytes of data (26 + 1), beginning at the address specified by the next two bytes. The controller stores 0x1A in the EEPROM and increments the EEPROM address pointer. |
| 0x0E22 | [7:0] | | The default value of these two registers is 0x0340. Because the previous register contains a data instruction, these two registers define a starting address (in this case, 0x0340). The controller stores 0x0340 in the EEPROM and increments the EEPROM pointer by 2. It then transfers 27 bytes from the register map (beginning at Address 0x0340) to the EEPROM and increments the EEPROM address pointer by 28 (27 data bytes and one checksum byte). The 27 bytes transferred correspond to the REFC parameters in the register map. |
| 0x0E23 | [7:0] | | |
| 0x0E24 | [7:0] | REFD | The default value of this register is 0x1A, which is a data instruction. Its decimal value is 26, which tells the controller to transfer 27 bytes of data (26 + 1), beginning at the address specified by the next two bytes. The controller stores 0x1A in the EEPROM and increments the EEPROM address pointer. |
| 0x0E25 | [7:0] | | The default value of these two registers is 0x0360. Because the previous register contains a data instruction, these two registers define a starting address (in this case, 0x0360). The controller stores 0x0360 in the EEPROM and increments the EEPROM pointer by 2. It then transfers 27 bytes from the register map (beginning at Address 0x0360) to the EEPROM and increments the EEPROM address pointer by 28 (27 data bytes and one checksum byte). The 27 bytes transferred correspond to the REFD parameters in the register map. |
| 0x0E26 | [7:0] | | |

Table 183. EEPROM Storage Sequence for DPLL_0 General Settings

| Address | Bits | Bit Name | Description |
|---------|-------|----------------------------|---|
| 0x0E27 | [7:0] | DPLL_0 general settings | The default value of this register is 0x15, which the controller interprets as a data instruction. Its decimal value is 21, which tells the controller to transfer 22 bytes of data (21 + 1), beginning at the address specified by the next two bytes. The controller stores 0x15 in the EEPROM and increments the EEPROM address pointer. |
| 0x0E28 | [7:0] | | The default value of these two registers is 0x0400. Because the previous register contains a data instruction, these two registers define a starting address (in this case, 0x0400). The controller stores 0x0400 in the EEPROM and increments the EEPROM pointer by 2. It then transfers 22 bytes from the register map (beginning at Address 0x0400) to the EEPROM and increments the EEPROM address pointer by 23 (22 data bytes and one checksum byte). The 22 bytes transferred correspond to the DPLL_0 general settings (for example, free running tuning word) in the register map. |
| 0x0E29 | [7:0] | | |

Table 184. EEPROM Storage Sequence for APLL_0 Configuration and Output Drivers

| Address | Bits | Bit Name | Description |
|---------|-------|--|---|
| 0x0E2A | [7:0] | APLL_0 config and output drivers | The default value of this register is 0x0E, which the controller interprets as a data instruction. Its decimal value is 14, which tells the controller to transfer 15 bytes of data (14 + 1) beginning at the address specified by the next two bytes. The controller stores 0x0E in the EEPROM and increments the EEPROM address pointer. |
| 0x0E2B | [7:0] | | The default value of these two registers is 0x0420. Because the previous register contains a data instruction, these two registers define a starting address (in this case, 0x0420). The controller stores 0x0420 in the EEPROM and increments the EEPROM pointer by 2. It then transfers 15 bytes from the register map (beginning at Address 0x0420) to the EEPROM and increments the EEPROM address pointer by 16 (15 data bytes and one checksum byte). The 15 bytes transferred correspond to the APLL_0 settings as well as the PLL_0 output driver settings in the register map. |
| 0x0E2C | [7:0] | | |

Table 185. EEPROM Storage Sequence for PLL_0 Dividers and BW Settings

| Address | Bits | Bit Name | Description |
|---------|-------|---------------------------|---|
| 0x0E2D | [7:0] | DPLL_0 dividers and BW | The default value of this register is 0x33, which the controller interprets as a data instruction. Its decimal value is 51, which tells the controller to transfer 52 bytes of data (51 + 1), beginning at the address specified by the next two bytes. The controller stores 0x33 in the EEPROM and increments the EEPROM address pointer. |
| 0x0E2E | [7:0] | | The default value of these two registers is 0x0440. Because the previous register contains a data instruction, these two registers define a starting address (in this case, 0x0440). The controller stores 0x0440 in the EEPROM and increments the EEPROM pointer by 2. It then transfers 52 bytes from the register map (beginning at Address 0x0440) to the EEPROM and increments the EEPROM address pointer by 53 (52 data bytes and one checksum byte). The 52 bytes transferred correspond to the DPLL_0 feedback dividers and loop BW settings in the register map. |
| 0x0E2F | [7:0] | | |

Table 186. EEPROM Storage Sequence for DPLL_1 General Settings

| Address | Bits | Bit Name | Description |
|---------|-------|----------------------------|---|
| 0x0E30 | [7:0] | DPLL_1 general settings | The default value of this register is 0x15, which the controller interprets as a data instruction. Its decimal value is 21, which tells the controller to transfer 22 bytes of data (21 + 1), beginning at the address specified by the next two bytes. The controller stores 0x15 in the EEPROM and increments the EEPROM address pointer. |
| 0x0E31 | [7:0] | | The default value of these two registers is 0x0500. Because the previous register contains a data instruction, these two registers define a starting address (in this case, 0x0500). The controller stores 0x0500 in the EEPROM and increments the EEPROM pointer by 2. It then transfers 22 bytes from the register map (beginning at Address 0x0500) to the EEPROM and increments the EEPROM address pointer by 23 (22 data bytes and one checksum byte). The 22 bytes transferred correspond to the DPLL_1 general settings (for example, free running tuning word) in the register map. |
| 0x0E32 | [7:0] | | |

Table 187. EEPROM Storage Sequence for APLL_1 Configuration and Output Drivers

| Address | Bits | Bit Name | Description |
|---------|-------|----------------------------------|---|
| 0x0E33 | [7:0] | APLL_1 config and output drivers | The default value of this register is 0x0E, which the controller interprets as a data instruction. Its decimal value is 14, which tells the controller to transfer 15 bytes of data (14 + 1) beginning at the address specified by the next two bytes. The controller stores 0x0E in the EEPROM and increments the EEPROM address pointer. |
| 0x0E34 | [7:0] | | The default value of these two registers is 0x0520. Because the previous register contains a data instruction, these two registers define a starting address (in this case, 0x0520). The controller stores 0x0520 in the EEPROM and increments the EEPROM pointer by 2. It then transfers 15 bytes from the register map (beginning at Address 0x0520) to the EEPROM and increments the EEPROM address pointer by 16 (15 data bytes and one checksum byte). The 15 bytes transferred correspond to the APLL_1 settings as well as the PLL_1 output driver settings in the register map. |
| 0x0E35 | [7:0] | | |

Table 188. EEPROM Storage Sequence for PLL_1 Dividers and BW Settings

| Address | Bits | Bit Name | Description |
|---------|-------|------------------------|---|
| 0x0E36 | [7:0] | DPLL_1 dividers and BW | The default value of this register is 0x33, which the controller interprets as a data instruction. Its decimal value is 52, which tells the controller to transfer 53 bytes of data (52 + 1), beginning at the address specified by the next two bytes. The controller stores 0x33 in the EEPROM and increments the EEPROM address pointer. |
| 0x0E37 | [7:0] | | The default value of these two registers is 0x0540. Because the previous register contains a data instruction, these two registers define a starting address (in this case, 0x0540). The controller stores 0x0540 in the EEPROM and increments the EEPROM pointer by 2. It then transfers 53 bytes from the register map (beginning at Address 0x0540) to the EEPROM and increments the EEPROM address pointer by 54 (53 data bytes and one checksum byte). The 53 bytes transferred correspond to the DPLL_1 feedback dividers and loop BW settings in the register map. |
| 0x0E38 | [7:0] | | |

Table 189. EEPROM Storage Sequence for Loop Filter Settings

| Address | Bits | Bit Name | Description |
|---------|-------|-------------|--|
| 0x0E39 | [7:0] | Loop filter | The default value of this register is 0x17, which the controller interprets as a data instruction. Its decimal value is 23, which tells the controller to transfer 24 bytes of data (23 + 1), beginning at the address specified by the next two bytes. The controller stores 0x17 in the EEPROM and increments the EEPROM address pointer. |
| 0x0E3A | [7:0] | | The default value of these two registers is 0x0800. Because the previous register contains a data instruction, these two registers define a starting address (in this case, 0x0800). The controller stores 0x0800 in the EEPROM and increments the EEPROM pointer by 2. It then transfers 24 bytes from the register map (beginning at Address 0x0800) to the EEPROM and increments the EEPROM address pointer by 25 (24 data bytes and one checksum byte). The 24 bytes transferred are the loop filter settings in the register map. |
| 0x0E3B | [7:0] | | |

Table 190. EEPROM Storage Sequence for Common Operational Control Settings

| Address | Bits | Bit Name | Description |
|---------|-------|-----------------------------|---|
| 0x0E3C | [7:0] | Common operational controls | The default value of this register is 0x0E, which the controller interprets as a data instruction. Its decimal value is 14, which tells the controller to transfer 15 bytes of data (14 + 1), beginning at the address specified by the next two bytes. The controller stores 0x0E in the EEPROM and increments the EEPROM address pointer. |
| 0x0E3D | [7:0] | | The default value of these two registers is 0x0A00. Because the previous register contains a data instruction, these two registers define a starting address (in this case, 0x0A00). The controller stores 0x0A00 in the EEPROM and increments the EEPROM pointer by 2. It then transfers 15 bytes from the register map (beginning at Address 0x0A00) to the EEPROM and increments the EEPROM address pointer by 16 (15 data bytes and one checksum byte). The 15 bytes transferred correspond to the common operational controls in the register map. |
| 0x0E3E | [7:0] | | |

Table 191. EEPROM Storage Sequence for PLL_0 Operational Control Settings

| Address | Bits | Bit Name | Description |
|---------|-------|----------------------------|---|
| 0x0E3F | [7:0] | PLL_0 operational controls | The default value of this register is 0x04, which the controller interprets as a data instruction. Its decimal value is 4, which tells the controller to transfer five bytes of data (4 + 1), beginning at the address specified by the next two bytes. The controller stores 0x04 in the EEPROM and increments the EEPROM address pointer. |
| 0x0E40 | [7:0] | | The default value of these two registers is 0x0A20. Because the previous register contains a data instruction, these two registers define a starting address (in this case, 0x0A20). The controller stores 0x0A20 in the EEPROM and increments the EEPROM pointer by 2. It then transfers five bytes from the register map (beginning at Address 0x0A20) to the EEPROM and increments the EEPROM address pointer by six (five data bytes and one checksum byte). The five bytes transferred correspond to the PLL_0 operational controls in the register map. |
| 0x0E41 | [7:0] | | |

Table 192. EEPROM Storage Sequence for PLL_1 Operational Control Settings

| Address | Bits | Bit Name | Description |
|---------|-------|----------------------------|---|
| 0x0E42 | [7:0] | PLL_1 operational controls | The default value of this register is 0x04, which the controller interprets as a data instruction. Its decimal value is 4, which tells the controller to transfer five bytes of data (4 + 1), beginning at the address specified by the next two bytes. The controller stores 0x04 in the EEPROM and increments the EEPROM address pointer. |
| 0x0E43 | [7:0] | | The default value of these two registers is 0x0A40. Because the previous register contains a data instruction, these two registers define a starting address (in this case, 0x0A40). The controller stores 0x0A40 in the EEPROM and increments the EEPROM pointer by 2. It then transfers five bytes from the register map (beginning at Address 0x0A40) to the EEPROM and increments the EEPROM address pointer by six (five data bytes and one checksum byte). The five bytes transferred correspond to the PLL_1 operational controls in the register map. |
| 0x0E44 | [7:0] | | |

Table 193. EEPROM Storage Sequence for APLL Calibration

| Address | Bits | Bit Name | Description |
|---------|-------|-----------------|--|
| 0x0E45 | [7:0] | IO_UPDATE | The default value of this register is 0x80, which the controller interprets as an IO_UPDATE instruction. The controller stores 0x80 in the EEPROM and increments the EEPROM address pointer. |
| 0x0E46 | [7:0] | Calibrate APLLs | The default value of this register is 0x90, which the controller interprets as a calibrate instruction for both APLLs. The controller stores 0x90 in the EEPROM and increments the EEPROM address pointer. |
| 0x0E47 | [7:0] | Sync outputs | The default value of this register is 0xA0, which the controller interprets as a distribution sync instruction for all of the output dividers. The controller stores 0xA0 in the EEPROM and increments the EEPROM address pointer. |

Table 194. EEPROM Storage Sequence for End of Data

| Address | Bits | Bit Name | Description |
|---------|-------|-------------|--|
| 0x0E48 | [7:0] | End of data | The default value of this register is 0xFF, which the controller interprets as an end instruction. The controller stores this instruction in the EEPROM, resets the EEPROM address pointer, and enters an idle state. Note that if the user replaces this command with a pause rather than an end instruction, the controller actions are the same except that the controller increments the EEPROM address pointer rather than resetting it. This allows the user to store multiple EEPROM profiles in the EEPROM. |

Table 195. Unused

| Address | Bits | Bit Name | Description |
|------------------|-------|----------|---|
| 0x0E49 to 0x0E4F | [7:0] | Unused | This area is unused in the default configuration and is available for additional EEPROM storage sequence commands. Note that the EEPROM storage sequence should always end with either an end of data or pause command. |

Table 196. Multifunction Pin Output Functions (D7 = 1)

| Bits[D7:D0] Value | Output Function | Source Proxy |
|---------------------|---|---|
| 0x80 | Static Logic 0 | None |
| 0x81 | Static Logic 1 | None |
| 0x82 | System clock divided by 32 | None |
| 0x83 | Watchdog timer output (40 ns strobe when timer expires) | None |
| 0x84 | EEPROM upload (write to EEPROM) in progress | Register 0x0D00, Bit 0 |
| 0x85 | EEPROM download (read from EEPROM) in progress | Register 0x0D00, Bit 1 |
| 0x86 | EEPROM fault detected | Register 0x0D00, Bit 2 |
| 0x88 | SYSCLK PLL lock detected | Register 0x0D01, Bit 0 |
| 0x89 | SYSCLK PLL stable | Register 0x0D01, Bit 1 |
| 0x8A | PLL_0 and PLL_1 all locked (logical AND of 0x8B and 0x8C) | Register 0x0D01, Bit 2 and Bit 3 |
| 0x8B | (DPLL_0 phase lock) and (APLL_0 lock) and (sys PLL lock) | Register 0x0D01, Bit 2 |
| 0x8C | (DPLL_1 phase lock) and (APLL_1 lock) and (sys PLL lock) | Register 0x0D01, Bit 3 |
| 0x90 | (IRQ_common) OR (IRQ_PLL_0) OR (IRQ_PLL_1) | None |
| 0x91 | IRQ_common | None |
| 0x92 | IRQ_PLL_0 | None |
| 0x93 | IRQ_PLL_1 | None |
| 0xA0/0xA1/0xA2/0xA3 | REFA/REFB/REFC/REFD fault | Register 0x0D02/0x0D03/0x0D04/0x0D05, Bit 2 |
| 0xA8/0xA9/0xAA/0xAB | REFA/REFB/REFC/REFD valid | Register 0x0D02/0x0D03/0x0D04/0x0D05, Bit 3 |
| 0xB0 | (DPLL_0 REFA active) OR (DPLL_1 REFA active) | Register 0x0D02, Bit 4 Bit 5 |
| 0xB1 | (DPLL_0 REFB active) OR (DPLL_1 REFB active) | Register 0x0D03, Bit 4 Bit 5 |
| 0xB2 | (DPLL_0 REFC active) OR (DPLL_1 REFC active) | Register 0x0D04, Bit 4 Bit 5 |
| 0xB3 | (DPLL_0 REFD active) OR (DPLL_1 REFD active) | Register 0x0D05, Bit 4 Bit 5 |
| 0xC0 | DPLL_0 phase locked | Register 0x0D20, Bit 1 |
| 0xC1 | DPLL_0 frequency locked | Register 0x0D20, Bit 2 |
| 0xC2 | APLL_0 lock detect | Register 0x0D20, Bit 3 |
| 0xC3 | APLL_0 cal in process | Register 0x0D20, Bit 4 |
| 0xC4 | DPLL_0 active | Register 0x0D0C, Bit 4 Bit 3 Bit 2 Bit 1 |
| 0xC5 | DPLL_0 in free run mode | Register 0x0D21, Bit 0 |
| 0xC6 | DPLL_0 in holdover | Register 0x0D21, Bit 1 |
| 0xC7 | DPLL_0 in reference switchover | Register 0x0D21, Bit 2 |
| 0xC8 | DPLL_0 tuning word history available | Register 0x0D22, Bit 0 |
| 0xC9 | DPLL_0 tuning word history updated | Register 0x0D0C, Bit 4 |
| 0xCA | DPLL_0 tuning word clamp activated | Register 0x0D22, Bit 1 |
| 0xCB | DPLL_0 phase slew limited | Register 0x0D22, Bit 2 |
| 0xCC | PLL_0 clock distribution sync pulse | Register 0x0D0D, Bit 4 |
| 0xD0 | DPLL_1 phase locked | Register 0x0D40, Bit 1 |
| 0xD1 | DPLL_1 frequency locked | Register 0x0D40, Bit 2 |
| 0xD2 | APLL_1 lock detect | Register 0x0D40, Bit 3 |
| 0xD3 | APLL_1 cal in process | Register 0x0D40, Bit 4 |
| 0xD4 | DPLL_1 active | Register 0x0D0F, Bit 4 Bit 3 Bit 2 Bit 1 |
| 0xD5 | DPLL_1 in free run mode | Register 0x0D41, Bit 0 |
| 0xD6 | DPLL_1 in holdover | Register 0x0D41, Bit 1 |
| 0xD7 | DPLL_1 in reference switchover | Register 0x0D41, Bit 2 |
| 0xD8 | DPLL_1 tuning word history available | Register 0x0D42, Bit 0 |
| 0xD9 | DPLL_1 tuning word history updated | Register 0x0D0F, Bit 4 |
| 0xDA | DPLL_1 tuning word clamp activated | Register 0x0D42, Bit 1 |
| 0xDB | DPLL_1 phase slew limited | Register 0x0D42, Bit 2 |
| 0xDC | PLL_1 clock distribution sync pulse | Register 0x0D10, Bit 4 |
| 0xDD to 0xFF | Reserved | |

Table 197. Multifunction Pin Input Functions (D7 = 0)

| Bits[D7:D0] Value | Output Function | Destination Proxy |
|---------------------|---|----------------------------|
| 0x00 | Reserved—high-Z input | None |
| 0x01 | IO_UPDATE | Register 0x0005, Bit 0 |
| 0x02 | Full power-down | Register 0x0A00, Bit 0 |
| 0x03 | Clear watchdog timer | Register 0x0A05, Bit 7 |
| 0x04 | Sync all channel dividers | Register 0x0A00, Bit 2 |
| 0x10 | Clear all IRQs | Register 0x0A05, Bit 0 |
| 0x11 | Clear common IRQs | Register 0x0A05, Bit 1 |
| 0x12 | Clear DPLL_0 IRQs | Register 0x0A05, Bit 2 |
| 0x13 | Clear DPLL_1 IRQs | Register 0x0A05, Bit 3 |
| 0x20/0x21/0x22/0x23 | Force fault REFA/REFB/REFC/REFD | Register 0x0A03, Bits[3:0] |
| 0x28/0x29/0x2A/0x2B | Force validation timeout REFA/REFB/REFC/REFD | Register 0x0A02, Bits[3:0] |
| 0x40 | PLL_0 power-down | Register 0x0A20, Bit 0 |
| 0x41 | DPLL_0 user free run | Register 0x0A22, Bit 0 |
| 0x42 | DPLL_0 user holdover | Register 0x0A22, Bit 1 |
| 0x43 | DPLL_0 tuning word history reset | Register 0x0A23, Bit 1 |
| 0x44 | DPLL_0 increment incremental phase offset | Register 0x0A24, Bit 0 |
| 0x45 | DPLL_0 decrement incremental phase offset | Register 0x0A24, Bit 1 |
| 0x46 | DPLL_0 reset incremental phase offset | Register 0x0A24, Bit 2 |
| 0x48 | APLL_0 sync clock distribution outputs | Register 0x0A20, Bit 2 |
| 0x49 | PLL_0 disable all output drivers | Register 0x0A21, Bits[3:2] |
| 0x4A | PLL_0 disable OUT0A | Register 0x0A21, Bit 2 |
| 0x4B | PLL_0 disable OUT0B | Register 0x0A21, Bit 3 |
| 0x4C | PLL_0 manual reference input selection, Bit 0 | Register 0x0A22, Bit 5 |
| 0x4D | PLL_0 manual reference input selection, Bit 1 | Register 0x0A22, Bit 6 |
| 0x50 | PLL_1 power-down | Register 0x0A40, Bit 0 |
| 0x51 | DPLL_1 user free run | Register 0x0A42, Bit 0 |
| 0x52 | DPLL_1 user holdover | Register 0x0A42, Bit 1 |
| 0x53 | DPLL_1 tuning word history reset | Register 0x0A43, Bit 1 |
| 0x54 | DPLL_1 increment incremental phase offset | Register 0x0A44, Bit 0 |
| 0x55 | DPLL_1 decrement incremental phase offset | Register 0x0A44, Bit 1 |
| 0x56 | DPLL_1 reset incremental phase offset | Register 0x0A44, Bit 2 |
| 0x58 | APLL_1 sync clock distribution outputs | Register 0x0A40, Bit 2 |
| 0x59 | PLL_1 disable all output drivers | Register 0x0A41, Bits[3:2] |
| 0x5A | PLL_1 disable OUT1A | Register 0x0A41, Bit 2 |
| 0x5B | PLL_1 disable OUT1B | Register 0x0A41, Bit 3 |
| 0x5C | PLL_1 manual reference input selection, Bit 0 | Register 0x0A42, Bit 5 |
| 0x5D | PLL_1 manual reference input selection, Bit 1 | Register 0x0A42, Bit 6 |
| 0x5E to 0x7F | Reserved | |

OUTLINE DIMENSIONS

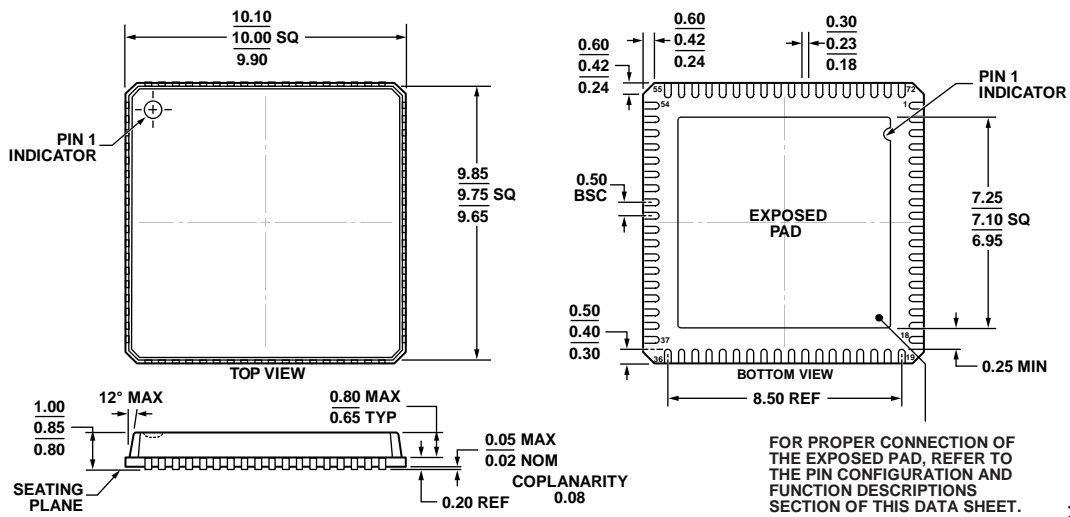

COMPLIANT TO JEDEC STANDARDS MO-220-VNND-4

Figure 57. 72-Lead Lead Frame Chip Scale Package [LFCSP_VQ]
 10 mm × 10 mm Body, Very Thin Quad
 (CP-72-4)

Dimensions shown in millimeters

06-25-2012-A

ORDERING GUIDE

| Model ¹ | Temperature Range | Package Description | Package Option |
|--------------------|-------------------|--|----------------|
| AD9559BCPZ | -40°C to +85°C | 72-Lead Lead Frame Chip Scale Package [LFCSP_VQ] | CP-72-4 |
| AD9559BCPZ-REEL7 | -40°C to +85°C | 72-Lead Lead Frame Chip Scale Package [LFCSP_VQ] | CP-72-4 |
| AD9559/PCBZ | -40°C to +85°C | Evaluation Board | CP-72-4 |

¹ Z = RoHS Compliant Part.

I²C refers to a communications protocol originally developed by Philips Semiconductors (now NXP Semiconductors).

X-ON Electronics

Largest Supplier of Electrical and Electronic Components

Click to view similar products for [Clock & Timer Development Tools](#) category:

Click to view products by [Analog Devices](#) manufacturer:

Other Similar products are found below :

[AD9517-0A/PCBZ](#) [AD9517-2A/PCBZ](#) [AD9522-4/PCBZ](#) [AD9520-5PCBZ](#) [AD9553/PCBZ](#) [ADCLK914PCBZ](#) [LMH2180SDEVAL](#) [DSC400-0333Q0032KE1-EVB](#) [TDGL013](#) [MAX2880EVKIT#](#) [MAX2750EVKIT](#) [MAX2752EVKIT](#) [ADCLK946PCBZ](#) [ADCLK946/PCBZ](#) [MAX2622EVKIT](#) [EKIT01-HMC1032LP6G](#) [Si5332-8IX-EVB](#) [RV-2251-C3-EVALUATION-BOARD](#) [Si5332-12IX-EVB](#) [RV-3029-C2-EVALUATION-BOARD-OPTION-B](#) [Si5332-6IX-EVB](#) [SKY72310-11-EVB](#) [EV1HMC8364LP6G](#) [RV-8263-C7-EVALUATION-BOARD](#) [EVK9FGV1002](#) [EVK9FGV1008](#) [EV1HMC6832ALP5L](#) [EVAL01-HMC830LP6GE](#) [EVAL01-HMC911LC4B](#) [TS3002DB](#) [125605-HMC702LP6CE](#) [LMX2487E-EVM](#) [MIKROE-2481](#) [2045](#) [EKIT01-HMC835LP6G](#) [EKIT01-HMC834LP6GE](#) [TS3006DB](#) [DSC-TIMEFLASH2-KIT1](#) [110227-HMC510LP5](#) [110227-HMC513LP5](#) [AD9515/PCBZ](#) [ADCLK948/PCBZ](#) [ADCLK954/PCBZ](#) [112261-HMC739LP4](#) [ADCLK925/PCBZ](#) [AD9522-0/PCBZ](#) [AD9520-4/PCBZ](#) [AC164147](#) [DFR0469](#) [LMK04133EVAL/NOPB](#)