

Integrated AMR Angle Sensor and Signal Conditioner with Differential Outputs

FEATURES

- ▶ Contactless angular measurement
- ▶ High precision 180° angle sensor
- ▶ Typical angular error of $\pm 0.1^\circ$
- ▶ Low output noise of 850 μV rms
- ▶ Sine and cosine differential outputs
- ▶ Ratiometric analog voltage outputs
- ▶ Negligible hysteresis
- ▶ SAR or $\Sigma\text{-}\Delta$ ADC compatible
- ▶ Temperature compensated AMR bridge
- ▶ Industrial temperature range: -40°C to $+125^\circ\text{C}$
- ▶ Automotive temperature range: -40°C to $+150^\circ\text{C}$
- ▶ EMI resistant
- ▶ Fault diagnostics
- ▶ V_{DD} from 2.7 V to 5.5 V
- ▶ Minimal phase error of 0.85° at 30,000 rpm
- ▶ AEC-Q100 qualified for automotive applications
- ▶ Single chip solution
- ▶ Available in an 8-lead SOIC package

APPLICATIONS

- ▶ Absolute position measurement (linear and angle)
- ▶ Brushless dc motor control and positioning
- ▶ Actuator control and positioning
- ▶ Contactless angular measurement and detection
- ▶ Magnetic angular position sensing

FUNCTIONAL BLOCK DIAGRAM

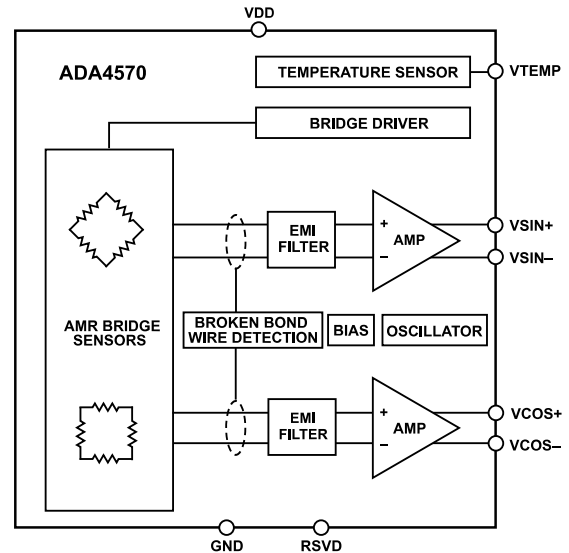

Figure 1.

GENERAL DESCRIPTION

The ADA4570 is an anisotropic magnetoresistive (AMR) sensor with integrated signal conditioning amplifiers and analog-to-digital converter (ADC) drivers. The ADA4570 produces two differential analog outputs that indicate the angular position of the surrounding magnetic field.

The ADA4570 consists of two die within one package, an AMR sensor, and a fixed gain instrumentation amplifier. The ADA4570 delivers amplified differential cosine and sine output signals, with respect to the angle, when the magnetic field is rotating in the x-axis and the y-axis (x-y) plane. The output voltage range is ratiometric to the supply voltage.

The sensor contains two Wheatstone bridges, at a relative angle of 45° to one another. A complete rotation of a dipole magnet produces two periods on the sinusoidal outputs. Therefore, the magnetic angle (α) calculated from the SIN and COS differential outputs represents the physical orientation of the magnet with respect to the ADA4570 in the 0° to 180° measurement range. Within a homogeneous field in the x-y plane, the output signals of the ADA4570 are independent of the physical placement in the z direction (air gap).

The ADA4570 is available in an 8-lead SOIC package.

TABLE OF CONTENTS

Features.....	1	Applications Information.....	11
Applications.....	1	Supply and ADC Reference.....	11
Functional Block Diagram.....	1	Connecting the ADA4570.....	11
General Description.....	1	Angle Calculation.....	11
Specifications.....	3	Signal Dependence on Air Gap Distance	11
Absolute Maximum Ratings.....	5	Signal Offset and Calibration.....	11
Electrostatic Discharge (ESD) Ratings.....	5	VTEMP Output Pin	12
Thermal Resistance.....	5	Power Consumption	12
ESD Caution.....	5	Diagnostic.....	12
Pin Configuration and Function Descriptions.....	6	Outline Dimensions.....	13
Typical Performance Characteristics.....	7	Ordering Guide.....	13
Terminology.....	9	Automotive Products.....	14
Theory of Operation.....	10		

REVISION HISTORY**7/2021—Revision 0: Initial Version**

SPECIFICATIONS

$V_{DD} = 2.7\text{ V to }5.5\text{ V}$, differential load capacitance (C_L) = 22 nF, load resistance (R_L) = 200 k Ω to GND. The operating temperature range (OTR) for the ADA4570B is $-40^\circ\text{C} \leq T_A \leq +125^\circ\text{C}$ and for the ADA4570WH is $-40^\circ\text{C} \leq T_A \leq +150^\circ\text{C}$. The angle inaccuracies referred to the homogenous magnetic field with a minimum flux density of 30 mT. All listed environmental conditions are valid, unless otherwise stated.

Table 1.

Parameter	Min	Typ	Max	Unit	Test Conditions/Comments
MAGNETIC CHARACTERISTICS					
Magnetic Flux Density, B_{EXT}	30			mT	The stimulating magnetic flux density in the x-y sensor plane necessary to ensure operation within specified limits
Magnetic Field Rotational Frequency			50,000	rpm	
Reference Position Error			± 50	μm	
Reference Angle Error			± 2	Degrees	
ANGULAR PERFORMANCE					
Angle Measurement Range	0		180	Degrees	
Uncorrected Angular Error ¹ (α_{UNCORR})					
ADA4570B/ADA4570WH			± 3	Degrees	$T_A = -40^\circ\text{C}$
			± 3	Degrees	$T_A = 25^\circ\text{C}$
			± 4	Degrees	$T_A = 125^\circ\text{C}$
ADA4570WH			± 5	Degrees	$T_A = 150^\circ\text{C}$
Single Point Calibration Angular Error ² (α_{CAL})					
ADA4570B/ADA4570WH		± 0.5		Degrees	$T_A = -40^\circ\text{C to }+125^\circ\text{C}$
ADA4570WH		± 0.7		Degrees	$T_A = -40^\circ\text{C to }+150^\circ\text{C}$
Dynamic Angular Error ^{3, 4} ($\alpha_{DYNAMIC}$)					
ADA4570B/ADA4570WH		± 0.1	± 0.4	Degrees	$T_A = -40^\circ\text{C to }+125^\circ\text{C}$
ADA4570WH		± 0.1	± 0.5	Degrees	$T_A = -40^\circ\text{C to }+150^\circ\text{C}$
OUTPUT PARAMETERS					
Differential Peak Amplitude (V_{AMP})					
ADA4570B/ADA4570WH	56		77	% V_{DD}	$T_A = -40^\circ\text{C}$
	52		72	% V_{DD}	$T_A = 25^\circ\text{C}$
	38		57	% V_{DD}	$T_A = 125^\circ\text{C}$
ADA4570WH	35		55	% V_{DD}	$T_A = 150^\circ\text{C}$
Single-Ended Output Voltage Range ⁵ (V_{O_SWING})	7		93	% V_{DD}	
Single-Ended Output Voltage Low ^{5, 6} (V_{OL})					
ADA4570B/ADA4570WH			3.75	% V_{DD}	$T_A = -40^\circ\text{C to }+125^\circ\text{C}$
ADA4570WH			5	% V_{DD}	$T_A = -40^\circ\text{C to }+150^\circ\text{C}$
Differential Output Referred Offset Voltage (V_{OFFSET})					
ADA4570B/ADA4570WH			3.75	% V_{DD}	$T_A = -40^\circ\text{C to }+125^\circ\text{C}$
ADA4570WH			3.9	% V_{DD}	$T_A = -40^\circ\text{C to }+150^\circ\text{C}$
Amplitude Synchronism ⁷ (k)	99		101	% peak	Differential measurement
Amplifier Propagation Delay ⁸ (t_{DEL})		2.35		μs	
Phase Error ^{8, 9} (Φ_{ERR})		0.85		Degrees	
Orthogonality Error			± 0.05	Degrees	
Output Noise (V_{NOISE})		850		$\mu\text{V rms}$	Bandwidth = 80 kHz, referred to output (RTO)
Output Series Resistance (R_O)		60		Ω	
Output -3 dB Cutoff Frequency (f_{-3dB})		175		kHz	Amplifier bandwidth, $C_L = 10\text{ pF}$
Power Supply Rejection (PSRR)		80		dB	Measured as output variation from $V_{DD}/2$, $V_{DD} = 5.0\text{ V}$, $T_A = 25^\circ\text{C}$

SPECIFICATIONS

Table 1.

Parameter	Min	Typ	Max	Unit	Test Conditions/Comments
Output Short-Circuit Current ¹⁰ (I_{SC})		15		mA	Short to GND per output pin, $V_{DD} = 5.0\text{ V}$, $T_A = 25^\circ\text{C}$
		16		mA	Short to V_{DD} per output pin, $V_{DD} = 5.0\text{ V}$, $T_A = 25^\circ\text{C}$
POWER SUPPLY					
Supply Voltage Range (V_{DD})	2.7		5.5	V	
Supply Current Range (I_{DD})	2.9	4.5	6.3	mA	No load
Power-Up Time (t_{PWUP})			150	μs	The time measured between V_{DD} reaching 90% of the supply voltage and angular measurement result being within 2° of the final angle
TEMPERATURE SENSOR					
Error Over Temperature (T_{ERR})		5		$^\circ\text{C}$	
Temperature Voltage Range (T_{RANGE})	0		82	% V_{DD}	$T_A = -40^\circ\text{C}$ to $+150^\circ\text{C}$
Temperature Coefficient (T_{CO})		3.173		mV/V/ $^\circ\text{C}$	
VTEMP Output Voltage Range	18		40	% V_{DD}	$T_A = 25^\circ\text{C}$
VTEMP Output Impedance		600		Ω	Buffered output
VTEMP Load Capacitance		22		nF	Optional load capacitance
VTEMP Short-Circuit Current (I_{SC_VTEMP})		3		mA	Short-circuit to GND, $V_{DD} = 5.0\text{ V}$, $T_A = 25^\circ\text{C}$
LOAD CAPACITOR					
External Differential Load Capacitance ¹¹ (C_L)		22		nF	

¹ α_{UNCORR} is the total mechanical angular error after the arctan computation. This error includes all sources of error over temperature before calibration. Error components such as offset, amplitude synchronism, amplitude synchronism drift, thermal offset drift, phase error, hysteresis, orthogonality error, and noise are included.

² α_{CAL} is the total mechanical angular error after the arctan computation. This error includes all sources of error over temperature after an initial offset (nulling) is performed at $T_A = 25^\circ\text{C}$. Error components such as amplitude synchronism drift, amplifier gain matching, thermal offset drift, phase error, hysteresis, orthogonality error, and noise are included.

³ Magnetic field rotation frequency = 1000 rpm.

⁴ $\alpha_{DYNAMIC}$ is the total mechanical angular error after the arctan computation. This error includes all sources of error over temperature after a continuous background calibration is performed to correct offset and amplitude synchronism errors. Error components such as phase error, hysteresis, orthogonality error, noise, and lifetime drift are included.

⁵ Applies to the VSIN+, VSIN-, VCOS+, and VCOS- outputs.

⁶ Broken bond wire detected.

⁷ Peak-to-peak amplitude matching. $k = 100 \times VSIN/VCOS$.

⁸ Magnetic field rotation frequency = 30000 rpm.

⁹ Rotation frequency dependent phase error after offset correction, amplitude calibration, and arctan calculation.

¹⁰ The short-circuit condition specified is present for each output at the following mechanical angles: short to VDD with VSIN+ at $\alpha = 135^\circ$, VSIN- at $\alpha = 45^\circ$, VCOS+ at $\alpha = 0^\circ$, and VCOS- at $\alpha = 90^\circ$ and short to GND with VSIN+ at $\alpha = 45^\circ$, VSIN- at $\alpha = 135^\circ$, VCOS+ at $\alpha = 9^\circ$, and VCOS- at $\alpha = 0^\circ$.

¹¹ Solder $C_L/4$ between VSIN+ and VSIN- and between VCOS+ and VCOS-. Solder $C_L/2$ between VSIN+ to GND, VSIN- to GND, VCOS+ to GND, and VCOS- to GND. Solder close to package.

ABSOLUTE MAXIMUM RATINGS

Table 2.

Parameter	Rating
Temperature	
Operating Range	
ADA4570B	-40°C to +125°C
ADA4570WH	-40°C to +150°C
Storage Range	-65°C to +150°C
Supply Voltage (V_{DD})	-0.3 V to +6 V

Stresses at or above those listed under Absolute Maximum Ratings may cause permanent damage to the product. This is a stress rating only; functional operation of the product at these or any other conditions above those indicated in the operational section of this specification is not implied. Operation beyond the maximum operating conditions for extended periods may affect product reliability.

ELECTROSTATIC DISCHARGE (ESD) RATINGS

The following ESD information is provided for handling of ESD-sensitive devices in an ESD protected area only.

Human Body Model (HBM) tested according to standard JESD22-C101. Charge Device Model (CDM) tested according to standard ESDA/JEDEC JS-001-2011.

Table 3. ADA4570, 8-Lead SOIC_N

ESD Model	Withstand Threshold (V)
HBM	4000
CDM	1250

THERMAL RESISTANCE

Thermal performance is directly linked to printed circuit board (PCB) design and operating environment. Careful attention to PCB thermal design is required.

θ_{JA} is the junction to ambient temperature, and θ_{JC} is the junction to case temperature.

Table 4. Thermal Resistance

Package Type ¹	θ_{JA}	θ_{JC}	Unit
R-8	120	39	°C/W

¹ Thermal performance per JEDEC defined (JESD-51) test specifications.

ESD CAUTION



ESD (electrostatic discharge) sensitive device. Charged devices and circuit boards can discharge without detection. Although this product features patented or proprietary protection circuitry, damage may occur on devices subjected to high energy ESD. Therefore, proper ESD precautions should be taken to avoid performance degradation or loss of functionality.

PIN CONFIGURATION AND FUNCTION DESCRIPTIONS

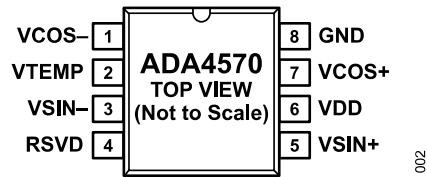

Figure 2. Pin Configuration

Table 5. Pin Function Descriptions

Pin No.	Mnemonic	Description
1	VCOS-	Analog Negative Cosine Output.
2	VTEMP	Analog Temperature Output. The VTEMP pin must be left open when not in use.
3	VSIN-	Analog Negative Sine Output.
4	RSVD	Reserved. The RSVD pin must be connected to GND.
5	VSIN+	Analog Positive Sine Output.
6	VDD	Power Supply.
7	VCOS+	Analog Positive Cosine Output.
8	GND	Ground.

TYPICAL PERFORMANCE CHARACTERISTICS

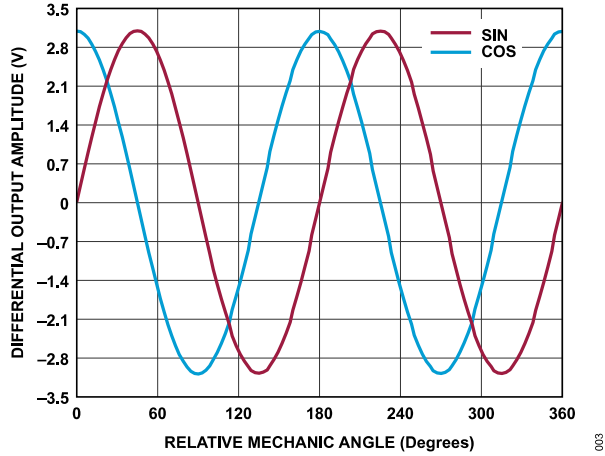

Figure 3. Differential Output Amplitude vs. Relative Mechanical Angle

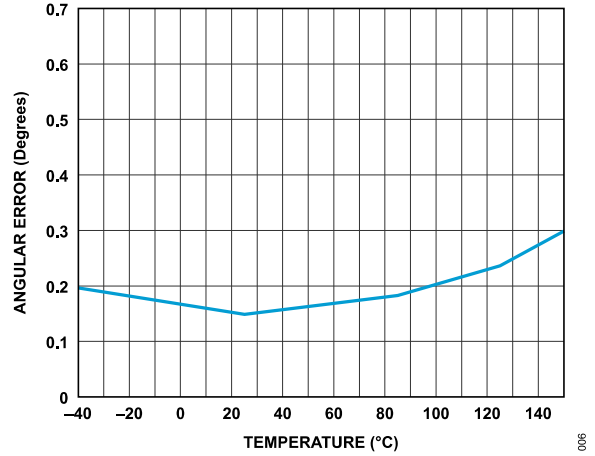

Figure 6. Single Point Calibration Angular Error vs. Temperature

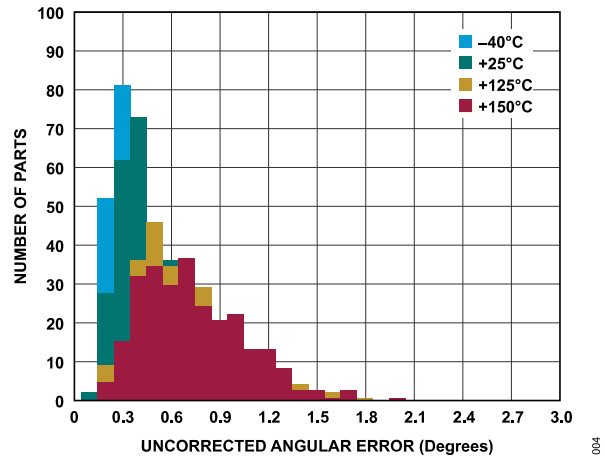

Figure 4. Uncorrected Angular Error Histogram

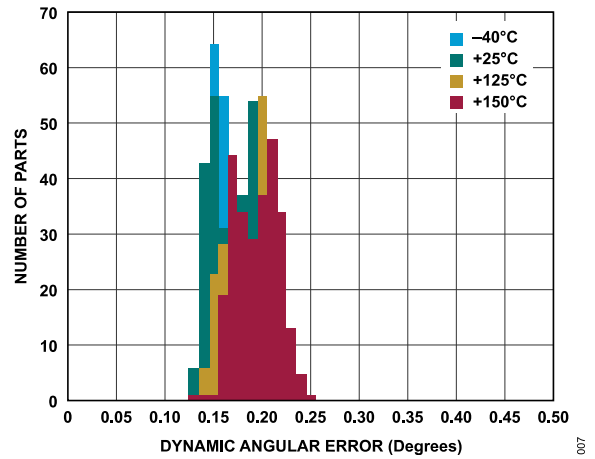

Figure 7. Dynamic Angular Error Histogram

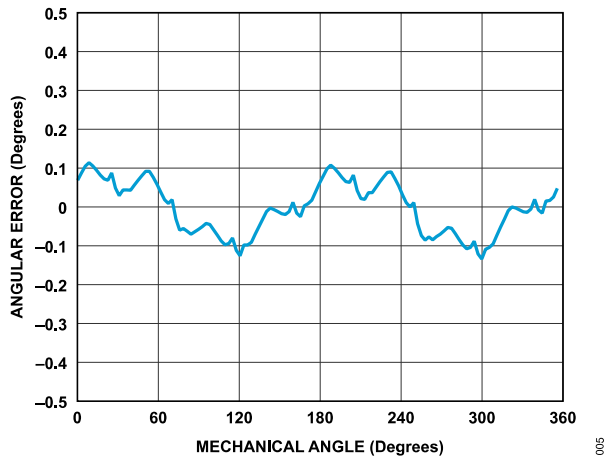

Figure 5. Angular Error vs. Mechanical Angle After Offset Correction

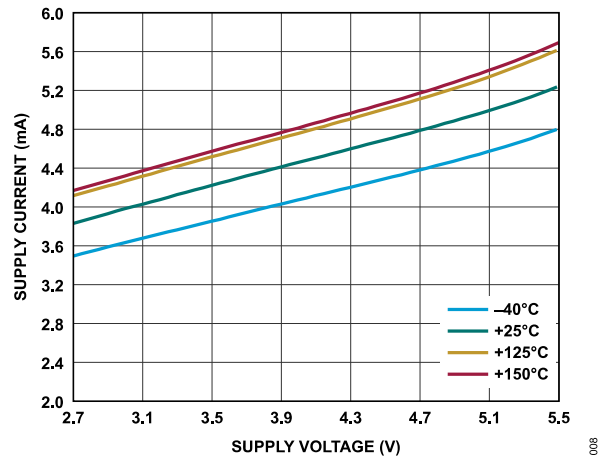

Figure 8. Supply Current vs. Supply Voltage

TYPICAL PERFORMANCE CHARACTERISTICS

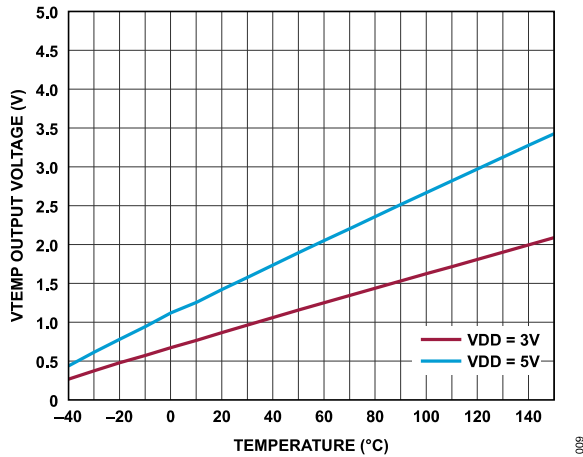

Figure 9. VTEMP Output Voltage vs. Temperature

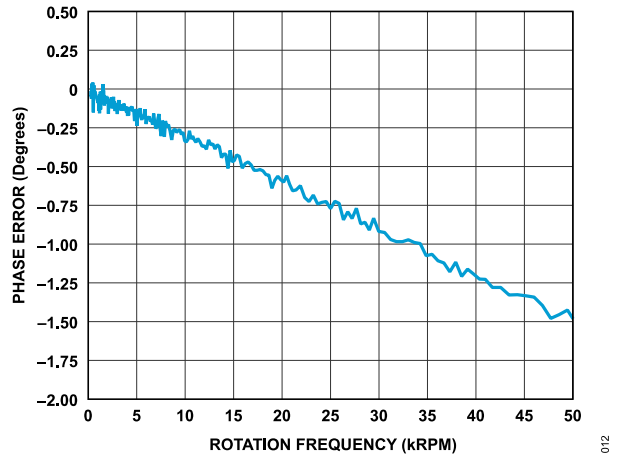

Figure 12. Phase Error vs. Mechanical RPM

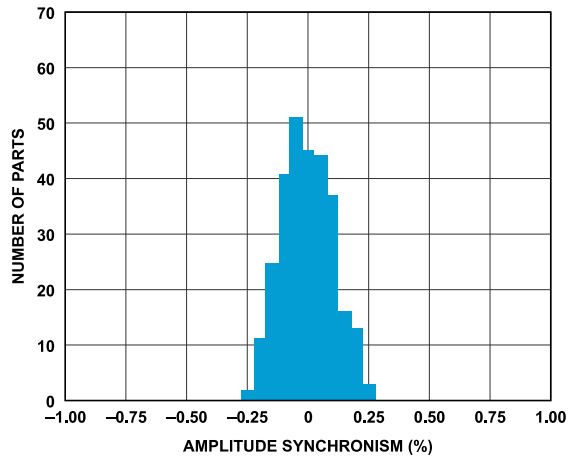

Figure 10. Amplitude Synchronism Histogram

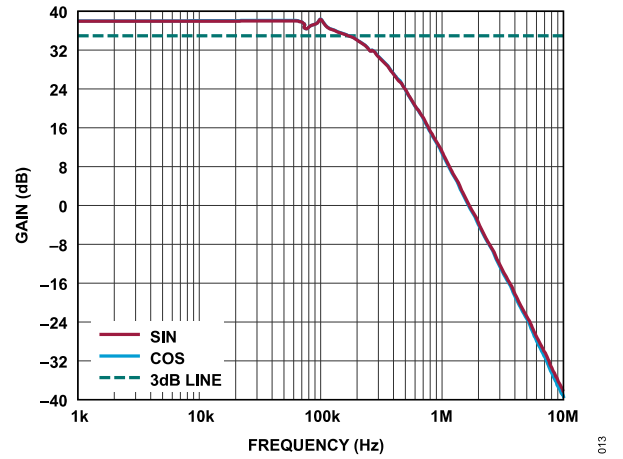

Figure 13. Frequency Response

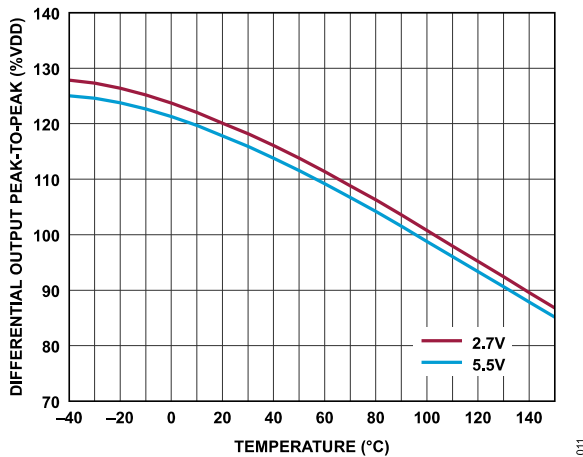

Figure 11. Differential Output Peak-to-Peak vs. Temperature

TERMINOLOGY

Output Signals

The output signals, VSIN+, VSIN-, VCOS+, and VCOS-, of the ADA4570 are biased around a common-mode voltage of VDD/2 as shown in Figure 14.

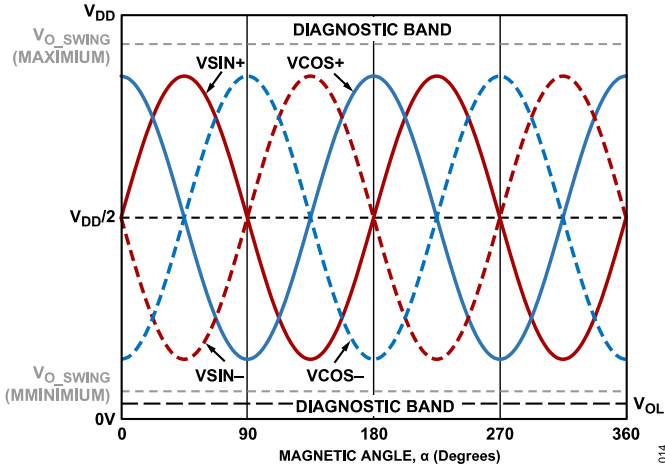

Figure 14. Single-Ended Output Voltage Range

The differential signal outputs, VSIN and VCOS, shown in Figure 15 are generated by sampling the corresponding positive and negative SIN and COS single-ended outputs.

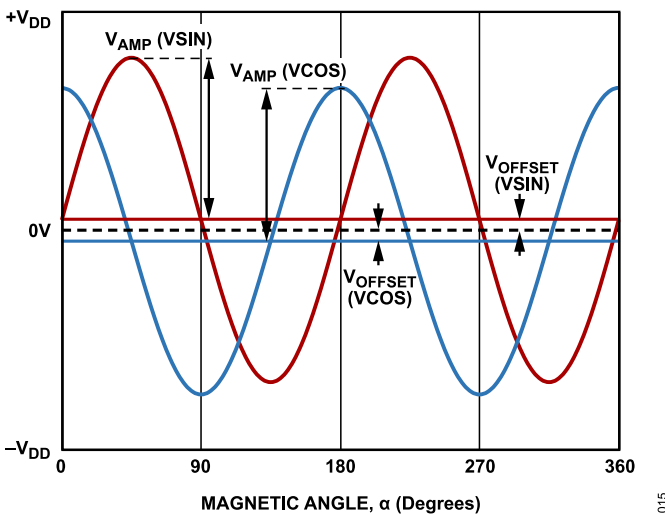

Figure 15. Differential Output Voltage Range

Reference Position Error

The reference position error is the deviation of the sensing element center from the nominal position shown in Figure 22.

Reference Angle Error

The reference angle error, indicated in Figure 16, is the absolute mounting angle error of the sensor from its nominal placement. The angle $\Phi = 0^\circ$ is referred to the straight line between the top of Pin 2 and Pin 7.

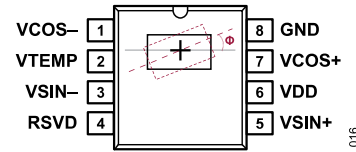

Figure 16. Sensor Alignment in Package

Uncorrected Angular Error

The uncorrected angular error is defined as the maximum deviation from an ideal angle without any calibration applied to the VSIN and VCOS differential signals.

Single Point Calibration Angular Error

The single point calibration angular error is defined as the deviation from an ideal angle after the offset calibration is applied to the VSIN and VCOS differential signals at 25°C.

Dynamic Angular Error

The dynamic angular error is defined as the maximum deviation from an ideal angle with the continuous offset and gain calibration applied to the VSIN and VCOS differential signals.

Output Amplitude Synchronism

The output amplitude synchronism (k) is defined as the ratio between the differential amplitudes of both channels when under a continuously rotating magnetic field. To calculate the amplitude synchronism, use the following equations:

$$k = 100\% \times V_{AMP}(VSIN)/V_{AMP}(VCOS)$$

Propagation Delay

The propagation delay is the amount of time taken for the signal to propagate to the VSIN and VCOS differential signal outputs in response to a magnetic stimulus change.

Phase Error

The phase error is defined as the average of the phase shift in the sine and cosine signal through the amplifier. The phase error increases with the rotation frequency due to the bandwidth limitation of the instrumentation amplifiers. As shown in Figure 12, the typical characteristics value can be used as a first-order compensation for the phase error.

Orthogonality Error

The orthogonality error is the internal phase error caused by misalignment of the sine and cosine sensor elements on-chip, with respect to the ideal 90° sine to cosine phase.

Single-Ended Output Voltage Low

The single-ended output voltage low is the maximum voltage level at the VSIN+, VSIN-, VCOS+, and VCOS- outputs when a broken bond wire is detected and all outputs are pulled low, see Figure 14.

THEORY OF OPERATION

As shown in the [Figure 1](#), the ADA4570 contains all the necessary peripherals for AMR angle sensing of a magnetic field in the x-y plane of the sensor.

The bridge driver provides the voltage supply to the AMR sensor. The sensitivity of AMR sensor is temperature dependent, and the bridge driver is designed to provide a supply voltage that compensates for the temperature dependence (see [Figure 17](#)).

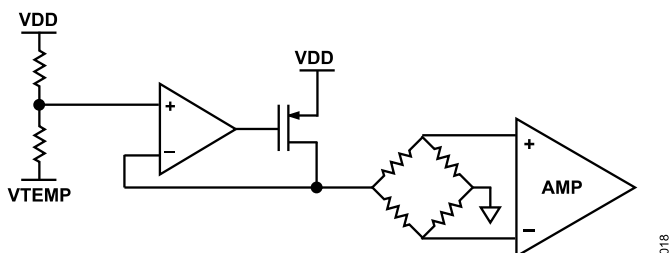

Figure 17. Temperature Compensated Bridge Driver

The ADA4570 consists of two dies that are connected internally by bond wires, the AMR sensor and an application specific IC (ASIC) that incorporates the electronics required to condition the output signals. A broken bond wire detection system was implemented in the ASIC that detects if any of the bond wires between the AMR bridge and ASIC become detached or broken. Note that when

a broken bond wire is detected, the VSIN and VCOS differential signal outputs are forced low.

Electromagnetic interference (EMI) filters are implemented at the AMR sensor outputs to prevent unwanted noise and interference from appearing in the signal band of the input to the instrumentation amplifier.

The architecture of the instrumentation amplifier consists of precision, low noise, zero drift amplifiers that feature a proprietary chopping technique. This chopping technique offers a low input offset voltage as well as a low input offset voltage drift. The zero drift design also features chopping ripple suppression circuitry that removes glitches and other artifacts caused by chopping.

Offset voltage errors caused by common-mode voltage swings and power supply variations are also corrected by the chopping technique, resulting in a very high dc common-mode rejection ratio. The amplifiers feature a low broadband noise of 33 nV/√Hz and no 1/f noise component. These features are ideal for amplification of the low level AMR bridge signals for high precision sensing applications.

The differential amplifier outputs, VSIN and VCOS, are capable of driving the inputs of an external ADC without requiring any additional signal conditioning, as shown in [Figure 18](#).

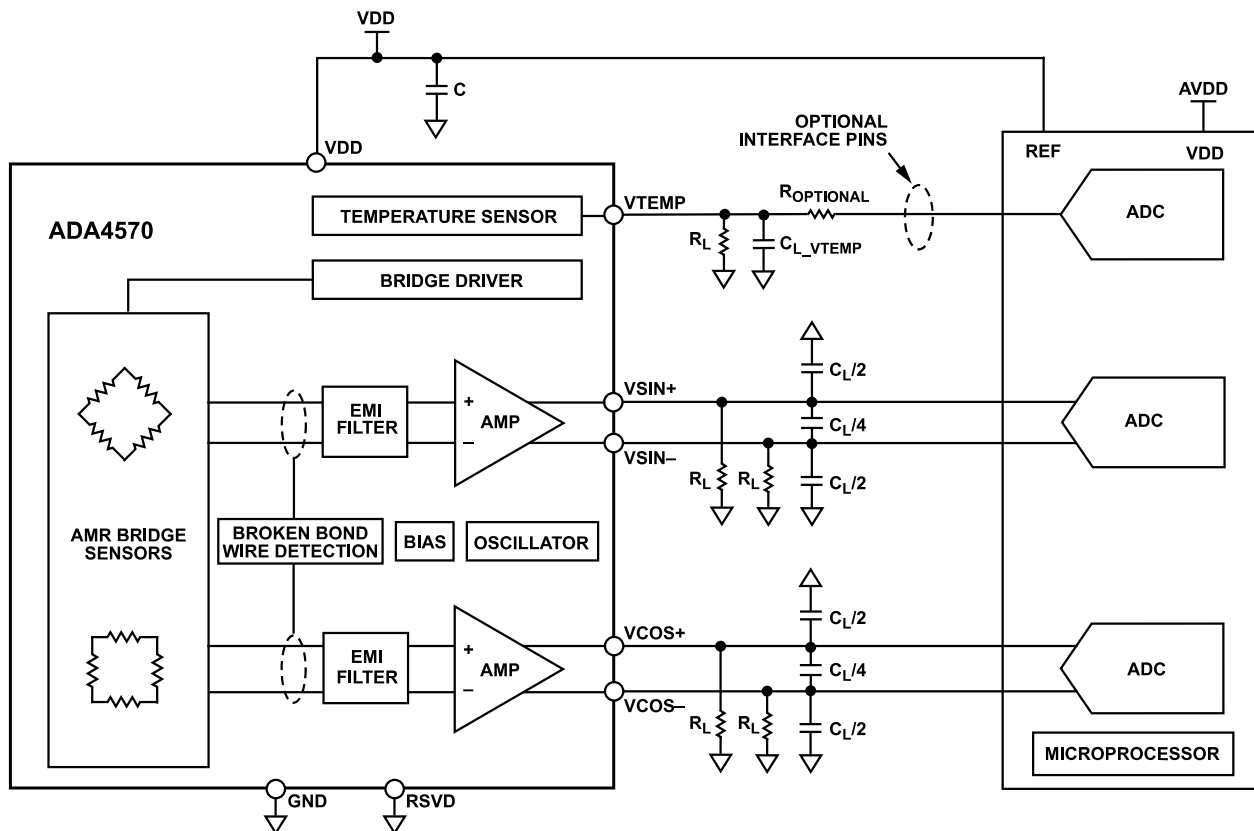

Figure 18. Typical Application Diagram

APPLICATIONS INFORMATION

The ADA4570 is designed for magnetoresistive sensing applications with a differential analog output. The sensor is designed to operate with an external ADC that is controlled by a separate processing IC or electronic control unit (ECU) as indicated in [Figure 18](#).

SUPPLY AND ADC REFERENCE

Connect a decoupling capacitance of 100 nF to the ADA4570 VDD supply pin to minimize interferences on the power supply from entering the system. To achieve optimum power supply related noise performance, connect the VDD supply of the ADA4570 as the voltage reference of the ADC, as shown in [Figure 18](#). Using the ADA4570 VDD supply as the reference input voltage to the external ADC provides a ratiometric configuration where the output dependency on the supply voltage changes is minimized. This configuration also optimizes the use of the ADC input range because the output voltages of the VSIN+, VSIN-, VCOS+, and VCOS- pins track the supply voltage.

CONNECTING THE ADA4570

A typical circuit to connect the ADA4570 to a differential ADC is shown in [Figure 18](#). The ADA4570 signal driving capability is sufficient to connect the analog outputs directly to a differential successive approximation register (SAR) or a Σ - Δ ADC.

Minimize the signal trace lengths to the ADC or the processing IC. Using proper layout techniques and ground planes around the analog signal tracks provides shielding on the PCB and improves electromagnetic compatibility (EMC) robustness. For each differential output, the load resistor (R_L) and the single-ended load capacitance ($C_L/2$) must refer to ground, and the differential load capacitance ($C_L/4$) must be connected between the differential outputs (see [Figure 18](#)). The load resistors and capacitors must match to achieve the best angular accuracy. In addition, take the desired system sampling frequency into account when adding noise reducing filters to the front of the ADC.

ANGLE CALCULATION

The angle of the incident magnetic field is calculated from the output of the ADA4570, and the trigonometric function arctangent(2) ($\arctan2$) is used. To calculate the ADA4570 output angle, use the following equation:

$$\alpha = \arctan2(\text{VSIN}/\text{VCOS})/2$$

With the sensing range of the AMR sensor, the calculated angle repeats every 180° rotation of the magnetic field. For a dipole magnet, the ADA4570 reports an angle with twice the frequency of the rotation.

The direction of a homogeneous magnetic field for an angle of $\alpha = 0^\circ$ is shown in [Figure 19](#)

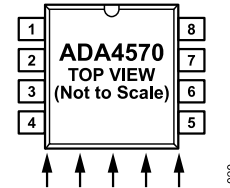

Figure 19. Direction of Homogeneous Magnetic Field for $\alpha = 0^\circ$

SIGNAL DEPENDENCE ON AIR GAP DISTANCE

The ADA4570 measures the direction of the external magnetic field within the sensor x-y plane.

Within a homogeneous field in the xy direction, where the magnetic flux density is at least 30 mT, the accuracy and voltage levels of the angular measurement is independent of the field strength and the sensor placement in z direction (air gap).

The nominal z distance of the internal x-y plane to the top surface of the plastic package is shown in [Figure 22](#).

SIGNAL OFFSET AND CALIBRATION

The ADA4570 provides two differential output signals, VSIN and VCOS, with an output voltage range of $\pm V_{AMP}$ (see [Figure 15](#)).

Matching inaccuracies and other imperfections during the production process may result in offsets in the outputs. To minimize additional offsets, caused by the external filter components, match the external capacitive and resistive loads to each other by using the same nominal values for the external components connected to VSIN+, VSIN-, VCOS+, and VCOS-.

To calculate the offset, use the positive and negative V_{AMP} value of a full magnetic rotation as follows:

$$V_{OFFSET} = (V_{AMP_POS} + V_{AMP_NEG})/2$$

The VSIN and VCOS output offset can be removed by subtracting the calculated offsets $V_{OFFSET}(\text{VSIN})$ and $V_{OFFSET}(\text{VCOS})$ from the VSIN and VCOS measurement result.

A single point calibration is usually done at 25°C and removes the system offset at this temperature. This simple calibration does not take temperature related offset drifts into account that may be caused by drifts within the internal or external components. This calibration may be sufficient for many applications in particular where no large changes in temperature are expected. To compensate for offset drifts over the full temperature range, dynamic offset calibrations are required.

APPLICATIONS INFORMATION

VTEMP OUTPUT PIN

An internal temperature sensor provides a voltage output at the VTEMP pin that can be used to monitor the operating temperature of the system and provide the reference for calibration. This output voltage (VTEMP) is ratiometric to the ADA4570 supply voltage.

Using an ADC, the reference of which is supplied by the VDD of the ADA4570, ensures that the digitized temperature measurement is also ratiometric.

To achieve maximum accuracy from the VTEMP output voltage, perform an initial calibration at a known and controlled temperature. To calculate the temperature, use the following equation:

$$T_{VTEMP} = \frac{\frac{V_{TEMP} - V_{CAL}}{V_{DD}} - T_{CAL} \times T_{CO}}{T_{CO}} \quad (1)$$

where:

T_{VTEMP} is the calculated temperature (°C) from the VTEMP output voltage.

V_{TEMP} is the VTEMP output voltage during operation.

V_{CAL} is the VTEMP output voltage during calibration at a controlled temperature.

T_{CAL} is the controlled temperature during calibration.

T_{CO} is the temperature coefficient of the internal circuit. See the [Specifications](#) section for the exact value.

V_{DD} is the supply voltage.

In [Figure 18](#), an optional resistor is shown in the VTEMP signal path to the ADC. When operating in a harsh environment, this resistor increases device immunity to EMI.

POWER CONSUMPTION

The power consumption is dependent on the supply voltage and temperature as shown in [Figure 8](#).

The analog outputs are protected against short circuit to the VDD pin or ground by a current limitation.

DIAGNOSTIC

Broken Bond Wire Detection

The ADA4570 includes the ability to detect broken bond wires between the AMR sensor and the ASIC. When this circuitry detects that the signal nodes are outside the normal operating region, the device pulls the VSIN+, VSIN-, VCOS+, and VCOS- analog output pins to ground. Monitor the voltage level of the analog signals to verify that the output level does not fall within the short-circuit diagnostic band shown in [Figure 20](#). If the outputs fall within the short-circuit diagnostic band shown in [Figure 20](#), the user must take the appropriate action.

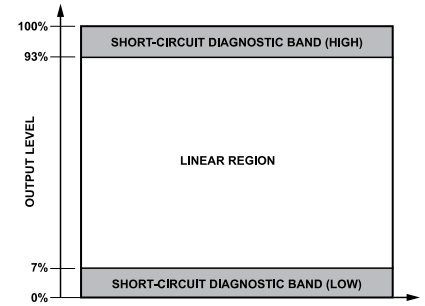

Figure 20. Short-Circuit Diagnostic Band

Short-Circuit Diagnostic Bands

The output levels of the ADA4570 were designed to be within the linear region shown in [Figure 20](#) during normal operation. Validate that the output levels are within the appropriate operating band. If any, or all, of the VSIN+, VSIN-, VCOS+, and VCOS- outputs are in the diagnostic bands, the outputs must be treated at the system level because this is an indication of a potential fault.

Radius Calculation

The differential signal outputs, VSIN and VCOS, from the ADA4570 can be used to calculate a radius (VRAD) of the circle at any angle of the applied magnetic field, as is shown in [Figure 21](#).

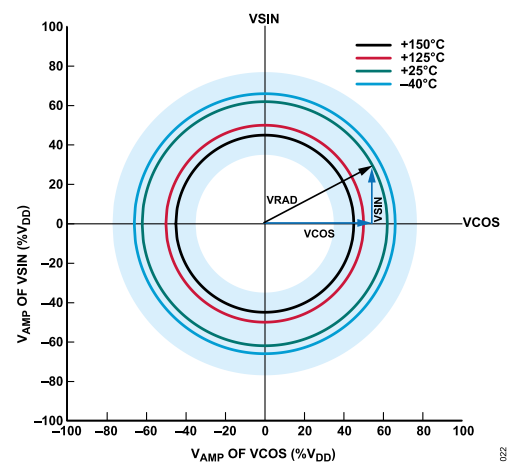

Figure 21. Radius Values

VRAD is equal to the vector sum of the differential signal outputs, VSIN and VCOS.

$$VRAD = \sqrt{VSIN^2 + VCOS^2}$$

Due to the constant phase difference of 90° between the measurements of the differential signal outputs, VSIN and VCOS, VRAD is constant over an entire magnetic revolution for a constant temperature and supply.

It is important to perform an offset calibration before a radius calculation is done.

OUTLINE DIMENSIONS

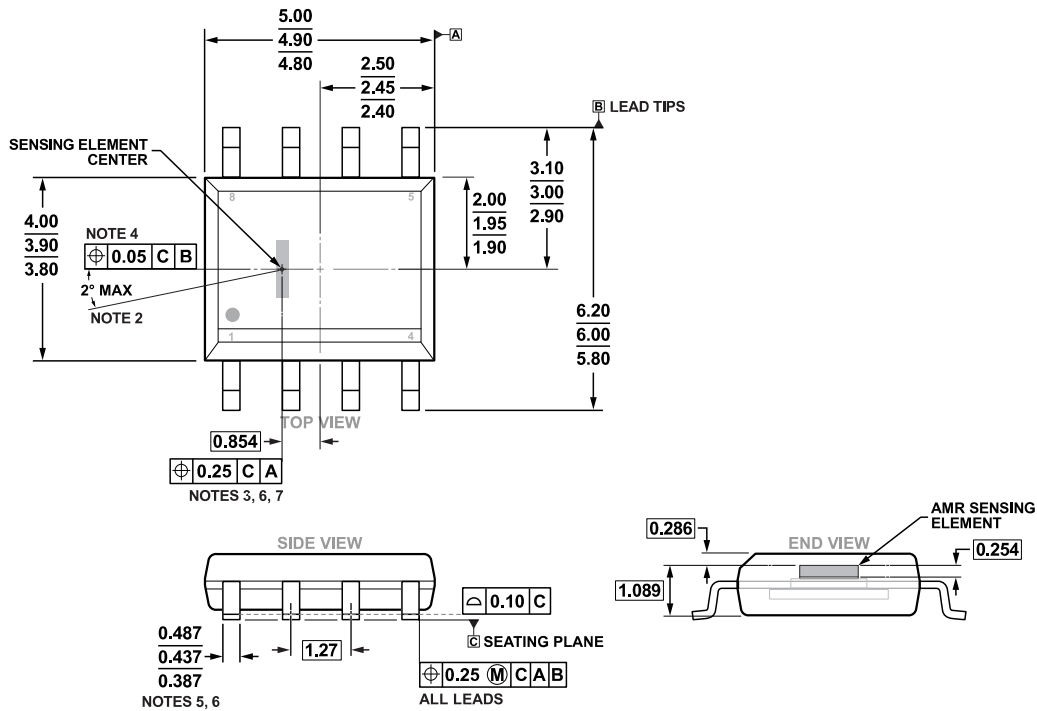

- NOTES**
1. DIMENSIONS ARE IN MILLIMETERS.
 2. MAXIMUM SENSOR ROTATION.
 3. THIS DIMENSION AND TRUE POSITION SPECIFY THE LOCATION OF THE CENTER OF THE SENSING ELEMENT WITH RESPECT TO THE CENTER OF THE PACKAGE. THE CENTER OF THE SENSING ELEMENT IS ALIGNED WITH THE EDGES OF LEAD 2 AND LEAD 7.
 4. THE CENTER OF THE SENSING ELEMENT IS ALIGNED WITH THE CENTER LINE OF THE PACKAGE (DATUM B).
 5. THE LEAD WIDTH DIMENSION IS TOLERANCED MORE TIGHTLY THAN ON THE R8 PACKAGE OUTLINE DRAWING. THIS DIMENSION IS MEASURED AT THE FOOT OF THE LEAD (NO FLASH, BURRS).
 6. DOES NOT INCLUDE MOLD FLASH, DAMBAR PROTRUSIONS, OR BURRS.
 7. MOLD BODY WIDTH AND LENGTH DIMENSIONS DO NOT INCLUDE MOLD FLASH, OFFSETS, OR MOLD GATE PROTRUSIONS.
 8. REFER TO THE R8 PACKAGE OUTLINE DRAWING FOR DIMENSIONS NOT SHOWN HERE.

Figure 22. 8-Lead Standard Small Outline Package [SOIC_N]
Narrow Body
(R-8)
Dimensions Shown in Millimeters

ORDERING GUIDE

Model ¹	Temperature Range	Package Description	Package Option
ADA4570BRZ	-40°C to +125°C	8-Lead Standard Small Outline Package [SOIC_N]	R-8
ADA4570BRZ-R7	-40°C to +125°C	8-Lead Standard Small Outline Package [SOIC_N]	R-8
ADA4570BRZ-RL	-40°C to +125°C	8-Lead Standard Small Outline Package [SOIC_N]	R-8
ADA4570WHRZ	-40°C to +150°C	8-Lead Standard Small Outline Package [SOIC_N]	R-8
ADA4570WHRZ-R7	-40°C to +150°C	8-Lead Standard Small Outline Package [SOIC_N]	R-8
ADA4570WHRZ-RL	-40°C to +150°C	8-Lead Standard Small Outline Package [SOIC_N]	R-8
EVAL-ADA4570SDZ		ADA4570 Evaluation Board	

¹ Z = RoHS-Compliant Part.

OUTLINE DIMENSIONS

AUTOMOTIVE PRODUCTS

The ADA4570W models are available with controlled manufacturing to support the quality and reliability requirements of automotive applications. Note that these automotive models may have specifications that differ from the commercial models; therefore, designers should review the [Specifications](#) section of this data sheet carefully. Only the automotive grade products shown are available for use in automotive applications. Contact your local Analog Devices account representative for specific product ordering information and to obtain the specific Automotive Reliability reports for these models.

X-ON Electronics

Largest Supplier of Electrical and Electronic Components

Click to view similar products for [Board Mount Hall Effect/Magnetic Sensors](#) category:

Click to view products by [Analog Devices](#) manufacturer:

Other Similar products are found below :

[HGPRDT005A](#) [AH1808-P-A](#) [AH277AZ4-AG1](#) [AV-10379](#) [AV-10448](#) [SS41C](#) [AH1803-WG-7](#) [AH1894-Z-7](#) [TLE4917](#) [50017859-003](#) [TY-13101](#) [TLE4976L](#) [SS85CA](#) [BU52002GUL-E2](#) [BU52003GUL-E2](#) [AH277AZ4-BG1](#) [TLE49614MXTSA1](#) [AH211Z4-AG1](#) [AH3360-FT4-7](#) [TLE4961-3M](#) [TLE4941-1](#) [SS460S-100SAMPLE](#) [50065820-03](#) [TLE4941PLUSCB](#) [AH374-P-A](#) [AH1806-P-A](#) [TLE49595UFXHALA1](#) [SS460P-T2](#) [AH1913-W-7](#) [TLE9852QXXUMA1](#) [MA732GQ-Z](#) [MA330GQ-Z](#) [TLE5046ICAKLRHALA1](#) [TLE49421CHAMA2](#) [AH1903-FA-EVM](#) [AH49FNTR-EVM](#) [AH8502-FDC-EVM](#) [AH3774-P-EVM](#) [TLE4998S3XALA1](#) [TLE5011FUMA1](#) [TLE5027CE6747HAMA1](#) [TLE5109A16E1210XUMA1](#) [TLI4966GHTSA1](#) [TLI4906KHTSA1](#) [MA710GQ-P](#) [EDC159S-A-30Y-97-5](#) [XR3\(xp8t\)](#) [S-57K1NBL2A-M3T2U](#) [S-57P1NBL9S-M3T4U](#) [S-576ZNL2B-L3T2U](#)