

FEATURES

- High precision 180° angle sensor
- Maximum angular error of 0.5°
- Analog sine and cosine outputs
- Ratiometric output voltages
- Low thermal and lifetime drift
- SAR or Σ - Δ analog-to-digital converter (ADC) drive capable
- Magnetostrictive (MR) bridge temperature compensation mode
- Temperature range: -40°C to +150°C
- EMI resistant
- Fault diagnostics
- V_{DD} from 2.7 V to 5.5 V
- Minimum phase delay
- Qualified for automotive applications
- Available in an 8-lead SOIC package

APPLICATIONS

- Absolute position measurement (linear and angle)
- Brushless dc motor control and positioning
- Actuator control and positioning
- Contactless angular measurement and detection
- Magnetic angular position sensing

GENERAL DESCRIPTION

The ADA4571 is an anisotropic magnetostrictive (AMR) sensor with integrated signal conditioning amplifiers and ADC drivers. The ADA4571 produces two analog outputs that indicate the angular position of the surrounding magnetic field.

The ADA4571 consists of two die within one package, an AMR sensor, and a fixed gain ($G = 40$ nominally) instrumentation amplifier. The ADA4571 delivers clean and amplified cosine and sine output signals related to the angle of a rotating magnetic field. The output voltage range is ratiometric to the supply voltage.

The sensor contains two Wheatstone bridges, at a relative angle of 45° to one another. A rotating magnetic field in the x-y sensor plane delivers two sinusoidal output signals with the double frequency of the angle (α) between sensor and magnetic field direction. Within a homogeneous field in the x-y plane, the output signals are independent of the physical placement in the z direction (air gap).

The ADA4571 is available in an 8-lead SOIC package.

FUNCTIONAL BLOCK DIAGRAM

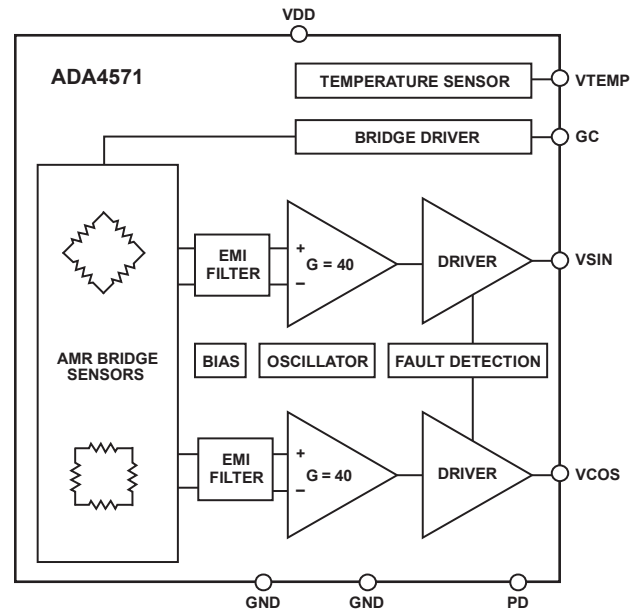

Figure 1.

12514-001

COMPANION PRODUCTS

ADCs: [AD7265](#), [AD7266](#), [AD7866](#), [AD7902](#)

Microconverter: [ADuCM360](#)

Current Sense Amplifier: [AD8418A](#)

Voltage Regulator Design Tool: [ADIsimPower](#)

Additional companion products on the [ADA4571 product page](#)

PRODUCT HIGHLIGHTS

1. Contactless angular measurement.
2. Measures magnetic field direction rather than field intensity.
3. Minimum sensitivity to air gap variations.
4. Large working distance.
5. Excellent accuracy, even for weak saturation fields.
6. Minimal thermal and lifetime drift.
7. Negligible hysteresis.
8. Single chip solution.

Rev. 0

[Document Feedback](#)

Information furnished by Analog Devices is believed to be accurate and reliable. However, no responsibility is assumed by Analog Devices for its use, nor for any infringements of patents or other rights of third parties that may result from its use. Specifications subject to change without notice. No license is granted by implication or otherwise under any patent or patent rights of Analog Devices. Trademarks and registered trademarks are the property of their respective owners.

TABLE OF CONTENTS

Features	1	Pin Configuration and Descriptions.....	8
Applications.....	1	Typical Performance Characteristics	9
Functional Block Diagram	1	Terminology	13
General Description	1	Theory of Operation	14
Companion Products	1	Application Information.....	16
Product Highlights	1	Angle Calculation.....	16
Revision History	2	Connection to ECU	16
Specifications.....	3	Mechanical Tolerances Diagrams	18
Magnetic Characteristics	3	Diagnostics.....	19
Electrical Characteristics	3	Outline Dimensions	21
Absolute Maximum Ratings.....	7	Ordering Guide	21
Thermal Resistance	7	Automotive Products.....	21
ESD Caution.....	7		

REVISION HISTORY

10/14—Revision 0: Initial Version

SPECIFICATIONS

MAGNETIC CHARACTERISTICS

Table 1.

Parameter	Value	Unit	Test Conditions/Comments
Magnetic Field Strength, H_{EXT}	25	kA/m	The stimulating magnetic field in the x-y sensor plane necessary to ensure the minimum error as specified in Table 1 and Table 2
Maximum Magnetic Field Rotational Frequency	50,000	rpm	
Reference Position Error	± 50	μm	Reference position for $y = 0 \mu\text{m}$ is the straight connection line of Pin 2 and Pin 7; the $x = 0 \mu\text{m}$ position is referred to the middle distance of the package top Reference position for angle $\Phi = 0^\circ$ is parallel to the straight connection line of Pin 2 and Pin 7
Reference Angle Error	± 2	Degrees	

ELECTRICAL CHARACTERISTICS

ADA4571WH

$-40^\circ\text{C} \leq T_A \leq +150^\circ\text{C}$, $V_{DD} = 2.7 \text{ V to } 5.5 \text{ V}$, $C_L = 10 \text{ nF to GND}$, $R_L = 200 \text{ k}\Omega \text{ to GND}$; angle inaccuracies referred to homogenous magnetic field of 25 kA/m; output signals and offset voltages are related to the common-mode level of $V_{DD}/2$, unless otherwise stated.

Table 2.

Parameter	Symbol	Test Conditions/Comments	Min	Typ	Max	Unit
ANGULAR PERFORMANCE						
Angle Measurement Range			0		180	Degrees
Uncorrected Angular Error ¹	α_{UNCORR}	$T_A = -40^\circ\text{C}$			± 5	Degrees
		$T_A = 25^\circ\text{C}$			± 5	Degrees
		$T_A = 150^\circ\text{C}$			± 5	Degrees
Single Point Calibration Angular Error ^{2,3}	α_{CAL}	$T_A = -40^\circ\text{C to } +150^\circ\text{C}$, GC = GND		± 0.7		Degrees
Dynamic Angular Error ⁴	$\alpha_{DYNAMIC}$	$T_A = -40^\circ\text{C to } +150^\circ\text{C}$, GC = V_{DD} $T_A = -40^\circ\text{C to } +150^\circ\text{C}$, rotation frequency = 2000 rpm		± 0.7 ± 0.1	± 0.5	Degrees Degrees
OUTPUT PARAMETERS						
Amplitude	V_{AMP}					
GC = GND		$T_A = -40^\circ\text{C}$	63		75	% V_{DD}
		$T_A = 25^\circ\text{C}$	41		53	% V_{DD}
		$T_A = 125^\circ\text{C}$	21		33	% V_{DD}
		$T_A = 150^\circ\text{C}$	18		30	% V_{DD}
GC = V_{DD}		$T_A = -40^\circ\text{C}$	56		77	% V_{DD}
		$T_A = 25^\circ\text{C}$	52		72	% V_{DD}
		$T_A = 125^\circ\text{C}$	38		57	% V_{DD}
		$T_A = 150^\circ\text{C}$	35		55	% V_{DD}
Output Voltage Range	V_{O_SWING}	VSIN and VCOS, normal operation	7		93	% V_{DD}
Output Voltage Low	V_{OL}	VSIN or VCOS, broken bond wire detected			5	% V_{DD}
Output Referred Offset Voltage	V_{OFFSET}	GC = V_{DD}			3.75	% V_{DD}
		GC = GND			3.75	% V_{DD}
Amplitude Synchronism Error ⁵	k		-1		+1	% peak
Delay Time	t_{DEL}	Rotation frequency = 30,000 rpm		2		μs
Phase Error ⁶	Φ_{ERR}	Rotation frequency = 30,000 rpm		0.8		Degrees
Orthogonality Error ³	OE				0.05	Degrees
Output Noise	V_{NOISE}	Bandwidth (BW) = 80 kHz, referred to output (RTO)		500		$\mu\text{V rms}$
Output Series Resistance	R_O	Normal operation, PD = GND		60		Ω
		PD = V_{DD}	63			k Ω
Output -3 dB Cutoff Frequency ³	f_{-3dB}	Amplifier BW, $C_L = 10 \text{ pF}$		100		kHz

Parameter	Symbol	Test Conditions/Comments	Min	Typ	Max	Unit
Power Supply Rejection ³	PSRR	Measured as output variation from $V_{DD}/2$, $V_{DD} = 2.7\text{ V to }5.5\text{ V}$, $R_L = 200\text{ k}\Omega$ to GND, GC = GND or V_{DD}		80		dB
Output Short-Circuit Current	I_{SC}	Short to GND per pin (VSIN, VCOS)	15	20		mA
		Short to VDD per pin (VSIN, VCOS)	-15	-18		mA
Sensitivity	SEN	$\alpha_1 = 0^\circ$, $\alpha_2 = 135^\circ$, $T_A = 25^\circ\text{C}$		52		mV/ $^\circ$
POWER SUPPLY						
Supply Voltage	V_{DD}		2.7		5.5	V
Quiescent Supply Current	I_{SY}	PD = GND, GC = GND, no load	3.5	4.5	6.5	mA
		PD = GND, GC = V_{DD} , no load			7	mA
		PD = V_{DD} , no load			15	μA
Power-Up Time	t_{PWRUP}	To 98% of desired output level after V_{DD} was reached			150	μs
		To 98% of desired output level after PD cycling			100	μs
DIGITAL INPUTS						
Input Bias Current (GC)	I_{B_GC}	For GC mode control pin, GC = GND			30	μA
		For GC mode control pin, GC = V_{DD}		3		μA
Input Bias Current (PD)	I_{B_PD}	For PD pin, PD = GND		3		μA
		For PD pin, PD = V_{DD}			30	μA
Input Voltage (GC and PD)						
High	V_{IH}		1.4			V
Low	V_{IL}				0.35	V
TEMPERATURE SENSOR						
Error Over Temperature	T_{ERR}			5		$^\circ\text{C}$
Temperature Voltage Range	T_{RANGE}	$T_A = -40^\circ\text{C to }+150^\circ\text{C}$	0		82	% V_{DD}
Temperature Coefficient	T_{CO}			3.173		mV/V/ $^\circ\text{C}$
VTEMP Output Voltage		$T_A = 25^\circ\text{C}$	18		40	% V_{DD}
VTEMP Output Impedance		Buffered output		50		Ω
VTEMP Load Capacitance		Optional load capacitance	0		22	nF
VTEMP Short-Circuit Current	I_{SC_VTEMP}	Short-circuit to VDD or GND	2			mA
LOAD CAPACITOR						
External Load Capacitance	C_L	Between VSIN to GND and VCOS to GND; solder close to package			10	nF

¹ α_{UNCORR} is the total mechanical angular error after arctan computation. This parameter is 100% production tested at 25°C and 150°C. This error includes all sources of error over temperature before calibration. Error components such as offset, amplitude synchronism, amplitude synchronism drift, thermal offset drift, phase error, hysteresis, orthogonality error, and noise are included.

² α_{CAL} is the total mechanical angular error after arctan computation. This error includes all sources of error over temperature after an initial offset (nulling) is performed at $T_A = 25^\circ\text{C}$. Error components such as amplitude synchronism drift, amplifier gain matching, thermal offset drift, phase error, hysteresis, orthogonality error, and noise are included.

³ Guaranteed through characterization.

⁴ $\alpha_{DYNAMIC}$ is the total mechanical angular error after arctan computation. This parameter is 100% production tested. This error includes all sources of error over temperature after a continuous background calibration is performed to correct offset and amplitude synchronism errors. Error components such as phase error, hysteresis, orthogonality error, noise, and lifetime drift are included.

⁵ Peak-to-peak amplitude mismatch. $k = 100 \times VSIN/VCOS$.

⁶ Rotation frequency dependent phase error, after offset correction, amplitude calibration, and arctan calculation.

ADA4571B

$-40^{\circ}\text{C} \leq T_A \leq +125^{\circ}\text{C}$, $V_{DD} = 2.7\text{ V to } 5.5\text{ V}$, $C_L = 10\text{ nF to GND}$, $R_L = 200\text{ k}\Omega\text{ to GND}$; angle inaccuracies referred to homogenous magnetic field of 25 kA/m; output signals and offset voltages are related to the common-mode level of $V_{DD}/2$, unless otherwise stated.

Table 3.

Parameter	Symbol	Test Conditions/Comments	Min	Typ	Max	Unit
ANGULAR PERFORMANCE						
Angle Measurement Range			0		180	Degrees
Uncorrected Angular Error ¹	α_{UNCORR}	$T_A = -40^{\circ}\text{C}$			± 3	Degrees
		$T_A = 25^{\circ}\text{C}$			± 3	Degrees
		$T_A = 125^{\circ}\text{C}$			± 4	Degrees
Single Point Calibration Angular Error ^{2,3}	α_{CAL}	$T_A = -40^{\circ}\text{C to } +125^{\circ}\text{C}$, GC = GND		± 0.5		Degrees
Dynamic Angular Error ⁴	α_{DYNAMIC}	$T_A = -40^{\circ}\text{C to } +125^{\circ}\text{C}$, GC = V_{DD} $T_A = -40^{\circ}\text{C to } +125^{\circ}\text{C}$, rotation frequency = 2000 rpm		± 0.5 0.1	± 0.4	Degrees
Angular Inaccuracy ^{3,5}	$\Delta\alpha$	After end of line (EOL) calibration for offset voltage error and amplitude synchronism at $T_A = -40^{\circ}\text{C to } +125^{\circ}\text{C}$ (only 180° range)		0.05		Degrees
OUTPUT PARAMETERS						
Amplitude	V_{AMP}					
GC = GND		$T_A = -40^{\circ}\text{C}$	63		75	% V_{DD}
		$T_A = 25^{\circ}\text{C}$	41		53	% V_{DD}
		$T_A = 125^{\circ}\text{C}$	21		33	% V_{DD}
GC = V_{DD}		$T_A = -40^{\circ}\text{C}$	56		77	% V_{DD}
		$T_A = 25^{\circ}\text{C}$	52		72	% V_{DD}
		$T_A = 125^{\circ}\text{C}$	38		57	% V_{DD}
Output Voltage Range	V_{O_SWING}	VSIN and VCOS, normal operation	7		93	% V_{DD}
Output Voltage Low	V_{OL}	VSIN or VCOS, broken bond wire detected			3.75	% V_{DD}
Output Referred Offset Voltage	V_{OFFSET}	GC = V_{DD}			3.75	% V_{DD}
		GC = GND			3.75	% V_{DD}
Amplitude Synchronism Error ⁶	k		-0.75		+0.75	% peak
Delay Time	t_{DEL}	Rotation frequency = 30,000 rpm		2		μs
Phase Error ⁷	Φ_{ERR}	Rotation frequency = 30,000 rpm		0.8		Degrees
Orthogonality Error ³	OE				0.05	Degrees
Output Noise	V_{NOISE}	BW = 80 kHz, RTO		500		$\mu\text{V rms}$
Output Series Resistance	R_O	Normal operation, PD = GND		50		Ω
		PD = V_{DD}	63			k Ω
Output -3 dB Cutoff Frequency ³	$f_{-3\text{dB}}$	Amplifier BW, $C_L = 10\text{ pF}$		100		kHz
Power Supply Rejection ³	PSRR	Measured as output variation from $V_{DD}/2$, $V_{DD} = 2.7\text{ V to } 5.5\text{ V}$, $R_L = 200\text{ k}\Omega\text{ to GND}$, GC = GND or V_{DD}		80		dB
Output Short-Circuit Current	I_{SC}	Short to GND per pin (VSIN, VCOS)	15	20		mA
		Short to VDD per pin (VSIN, VCOS)	-15	-18		mA
Sensitivity	SEN	$\alpha = 0^{\circ}$ and 135° , $T_A = 25^{\circ}\text{C}$		52		mV/ $^{\circ}$
POWER SUPPLY						
Supply Voltage	V_{DD}		2.7		5.5	V
Quiescent Supply Current	I_{SY}	PD = GND, GC = GND, no load	3.5	4.5	6	mA
		PD = GND, GC = V_{DD}			6.5	mA
		PD = V_{DD} , no load			12.5	μA
Power-Up Time	t_{PWRUP}	To 98% of desired output level after V_{DD} was reached			150	μs
		To 98% of desired output level after PD cycling			100	μs

Parameter	Symbol	Test Conditions/Comments	Min	Typ	Max	Unit
DIGITAL INPUTS						
Input Bias Current (GC)	I_{B_GC}	For GC mode control pin, GC = GND			30	μA
		For GC mode control pin, GC = V_{DD}		3		μA
Input Bias Current (PD)	I_{B_PD}	For PD pin, PD = GND		3		μA
		For PD pin, PD = V_{DD}			30	μA
Input Voltage (GC and PD)						
High	V_{IH}		1.4			V
Low	V_{IL}				0.35	V
TEMPERATURE SENSOR						
Error Over Temperature	T_{ERR}			5		$^{\circ}\text{C}$
Temperature Voltage Range	T_{RANGE}	$T_A = -40^{\circ}\text{C}$ to $+125^{\circ}\text{C}$	0		69	$\% V_{DD}$
Temperature Coefficient	T_{CO}			3.173		$\text{mV}/\text{V}/^{\circ}\text{C}$
VTEMP Output Voltage		$T_A = 25^{\circ}\text{C}$	18		40	$\% V_{DD}$
VTEMP Output Impedance		Buffered output		50		Ω
VTEMP Load Capacitance		Optional load capacitance	0		22	nF
VTEMP Short-Circuit Current	I_{SC_VTEMP}	Short-circuit to VDD or GND	2			mA
LOAD CAPACITOR						
External Load Capacitance	C_L	Between VSIN to GND and VCOS to GND; solder close to package			10	nF

¹ α_{UNCORR} is the total mechanical angular error after arctan computation. This parameter is 100% production tested at 25°C and 150°C . This error includes all sources of error over temperature before calibration. Error components such as offset, amplitude synchronism, amplitude synchronism drift, thermal offset drift, phase error, hysteresis, orthogonality error, and noise are included.

² α_{CAL} is the total mechanical angular error after arctan computation. This error includes all sources of error over temperature after an initial offset (nulling) is performed at $T_A = 25^{\circ}\text{C}$. Error components such as amplitude synchronism drift, amplifier gain matching, thermal offset drift, phase error, hysteresis, orthogonality error, and noise are included.

³ Guaranteed through characterization.

⁴ $\alpha_{DYNAMIC}$ is the total mechanical angular error after arctan computation. This parameter is 100% production tested. This error includes all sources of error over temperature after a continuous background calibration is performed to correct offset and amplitude synchronism errors. Error components such as phase error, hysteresis, orthogonality error, noise, and lifetime drift are included.

⁵ Angular speed < 300 rpm. Limited to 180° rotation. The value is calculated only with the third and fifth harmonics of the spectrum of output signal amplitude by the ideal homogeneous field.

⁶ Peak-to-peak amplitude mismatch. $k = 100 \times VSIN/VCOS$.

⁷ Rotation frequency dependent phase error, after offset correction, amplitude calibration, and arctan calculation.

ABSOLUTE MAXIMUM RATINGS

Table 4.

Parameter	Rating
Operating Temperature	−40°C to +150°C
Storage Temperature	−65°C to +150°C
Supply Voltage (V _{DD}) ¹	−0.3 V to +6 V
Output Short-Circuit Duration to GND or VDD	Indefinite
VTEMP Short-Circuit to GND or VDD	Indefinite
ESD	
Human Body Model (HBM) ²	4000 V
Machine Model (MM) ³	300 V
Charge Device Model (CDM) ⁴	1250 V

¹ GC or PD at VDD + 0.3 V.

² Applicable standard: JESD22-C101.

³ Applicable standard: JESD22-A115.

⁴ Applicable standard: ESDA/JEDEC JS-001-2011.

Stresses at or above those listed under Absolute Maximum Ratings may cause permanent damage to the product. This is a stress rating only; functional operation of the product at these or any other conditions above those indicated in the operational section of this specification is not implied. Operation beyond the maximum operating conditions for extended periods may affect product reliability.

THERMAL RESISTANCE

θ_{JA} is specified for the worst case conditions, that is, a device soldered in a circuit board for surface-mount packages.

Table 5. Thermal Resistance

Package Type	θ_{JA}	Unit
8-Lead SOIC	120	°C/W

ESD CAUTION



ESD (electrostatic discharge) sensitive device. Charged devices and circuit boards can discharge without detection. Although this product features patented or proprietary protection circuitry, damage may occur on devices subjected to high energy ESD. Therefore, proper ESD precautions should be taken to avoid performance degradation or loss of functionality.

PIN CONFIGURATION AND DESCRIPTIONS

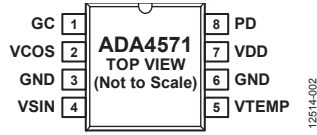

Figure 2. Pin Configuration

Table 6. Pin Function Descriptions

Pin No.	Mnemonic	Description
1	GC	Gain Control Mode Enable
2	VCOS	Analog Cosine Output
3	GND	Ground
4	VSIN	Analog Sine Output
5	VTEMP	Temperature Output
6	GND	Ground
7	VDD	Supply Pin
8	PD	Power-Down Pin, Active High

TYPICAL PERFORMANCE CHARACTERISTICS

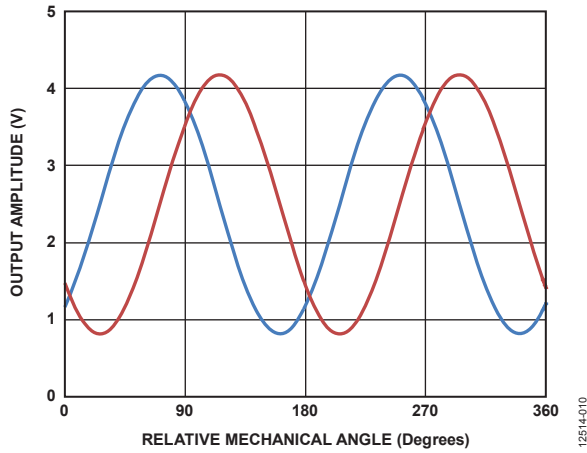

Figure 3. Raw Output Waveforms, $V_{DD} = 5\text{ V}$, $GC = \text{On}$, $T = 25^\circ\text{C}$

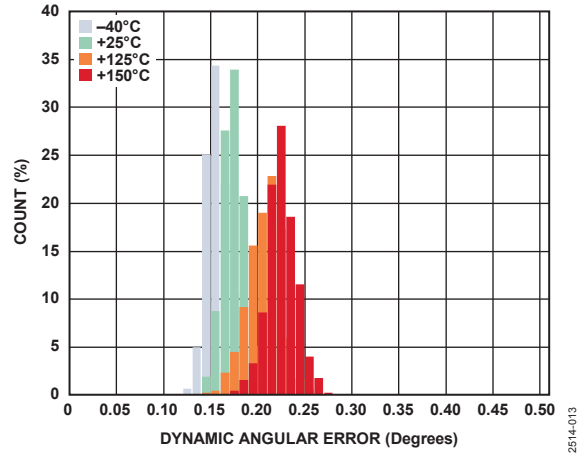

Figure 6. Dynamic Angular Error, $V_{DD} = 5.5\text{ V}$, $GC = \text{Off}$

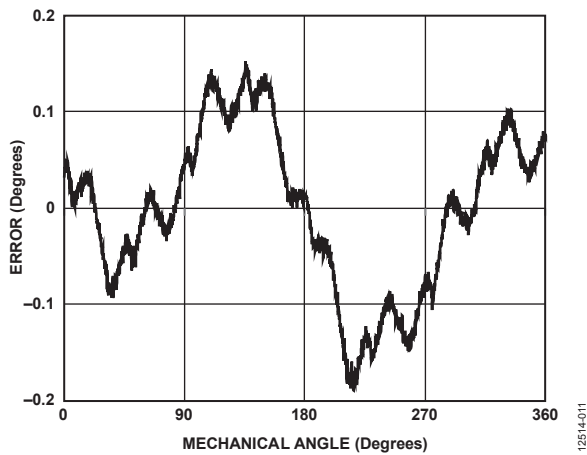

Figure 4. Error Waveform After Offset Correction, $V_{DD} = 5\text{ V}$, $GC = \text{On}$

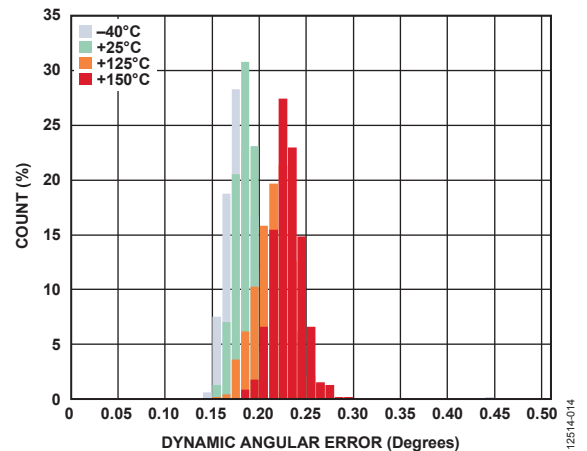

Figure 7. Dynamic Angular Error, $V_{DD} = 2.7\text{ V}$, $GC = \text{On}$

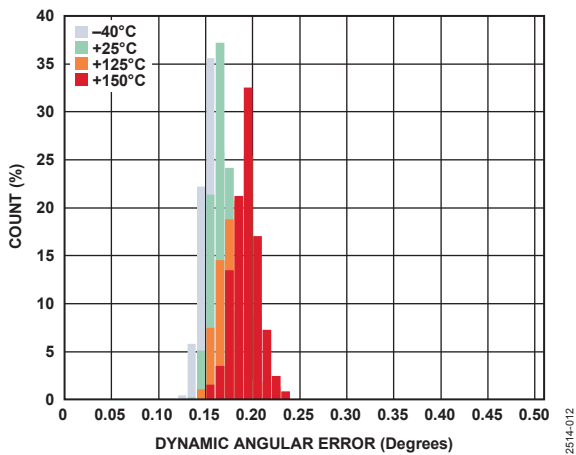

Figure 5. Dynamic Angular Error, $V_{DD} = 5.5\text{ V}$, $GC = \text{On}$

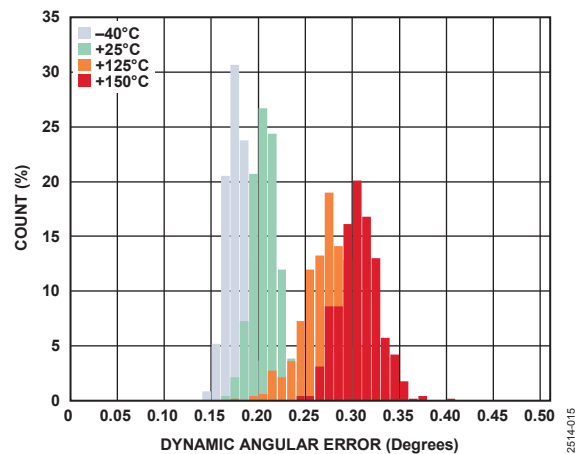

Figure 8. Dynamic Angular Error, $V_{DD} = 2.7\text{ V}$, $GC = \text{Off}$

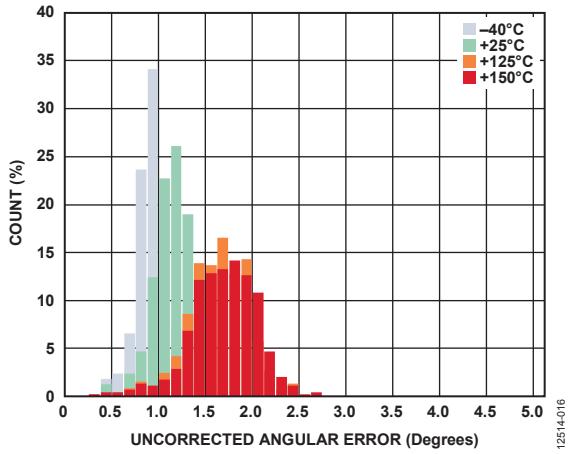

Figure 9. Uncorrected Angular Error, $V_{DD} = 5.5\text{ V}$, $GC = \text{On}$

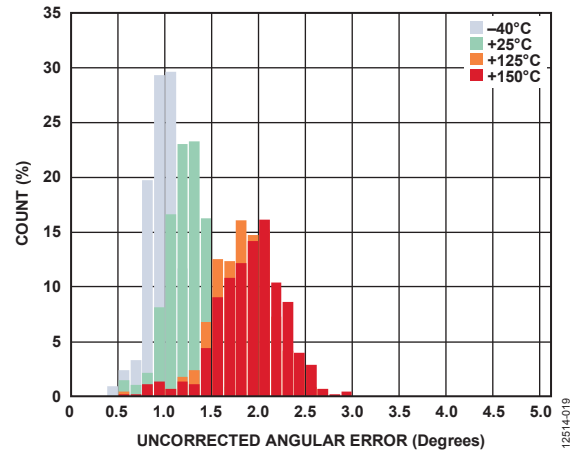

Figure 12. Uncorrected Angular Error, $V_{DD} = 2.7\text{ V}$, $GC = \text{Off}$

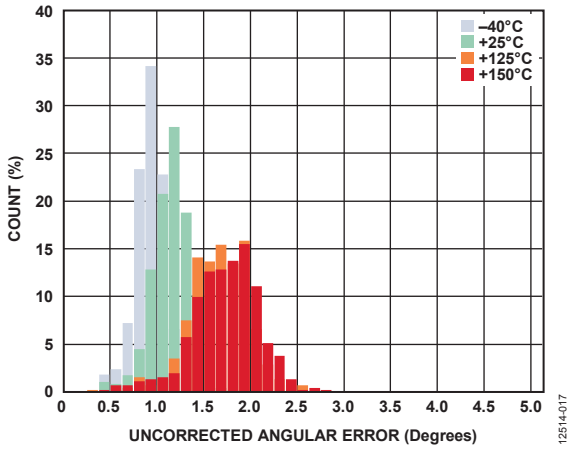

Figure 10. Uncorrected Angular Error, $V_{DD} = 5.5\text{ V}$, $GC = \text{Off}$

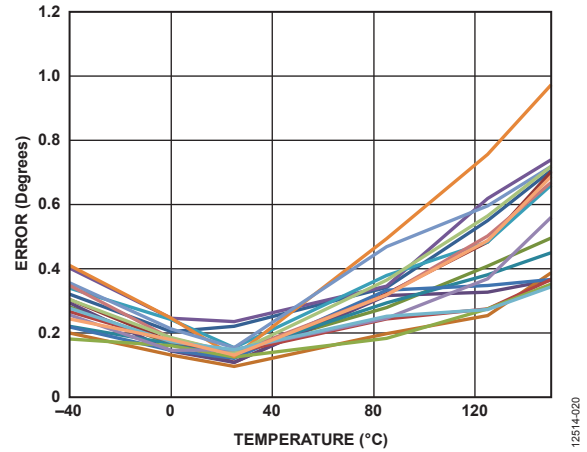

Figure 13. Single Point Calibration Angular Error, $V_{DD} = 5.5\text{ V}$, $GC = \text{On}$

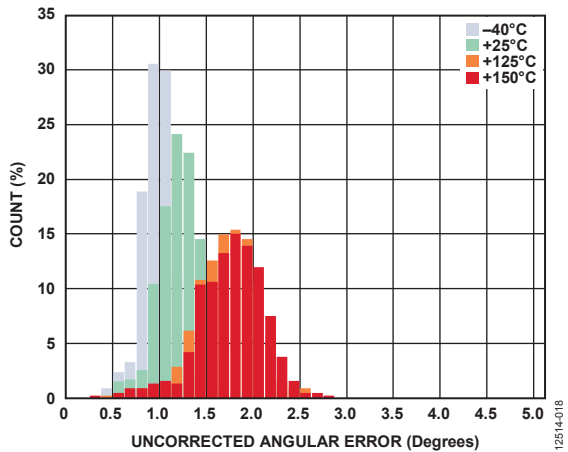

Figure 11. Uncorrected Angular Error, $V_{DD} = 2.7\text{ V}$, $GC = \text{On}$

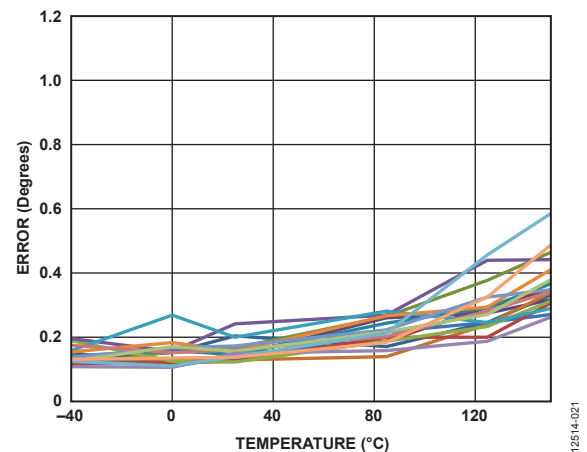

Figure 14. Single Point Calibration Angular Error, $V_{DD} = 5.5\text{ V}$, $GC = \text{Off}$

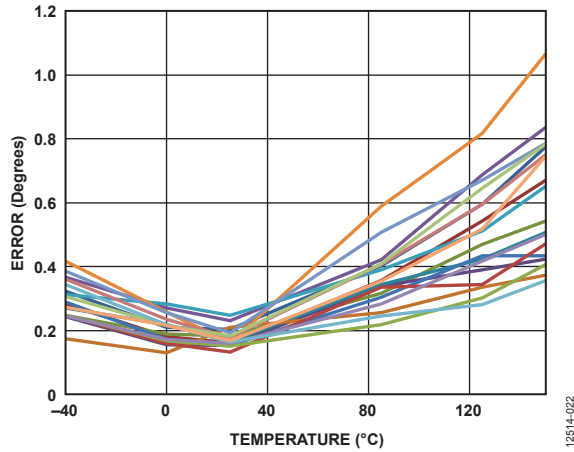

Figure 15. Single Point Calibration Angular Error, $V_{DD} = 2.7\text{ V}$, GC = On

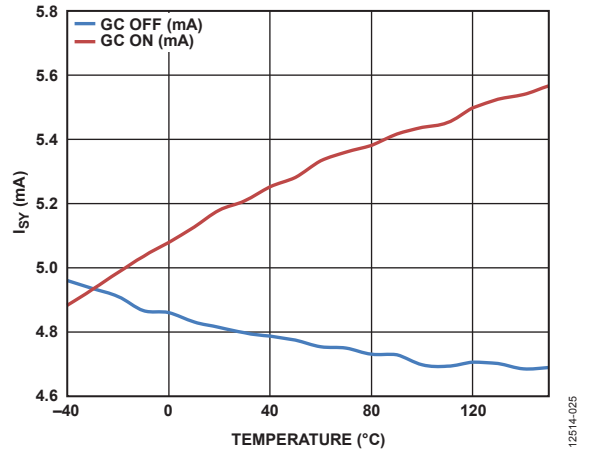

Figure 18. Supply Current (I_{Sy}) vs. Temperature, $V_{DD} = 5\text{ V}$

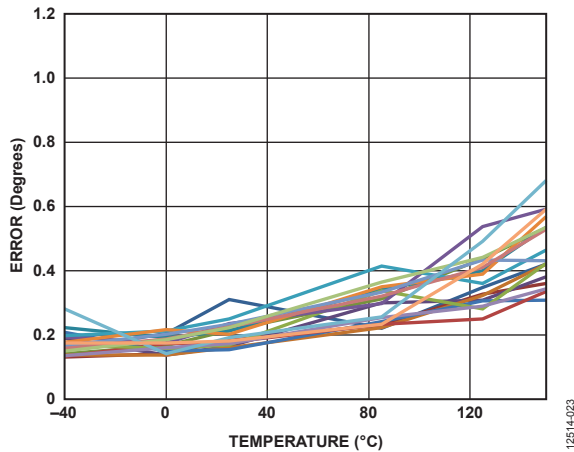

Figure 16. Single Point Calibration Angular Error, $V_{DD} = 2.7\text{ V}$, GC = Off

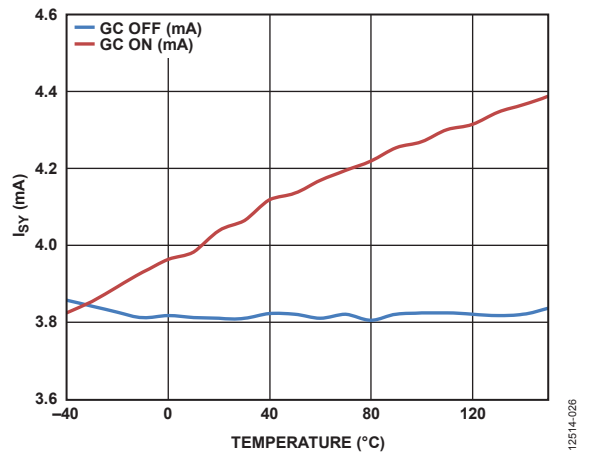

Figure 19. Supply Current (I_{Sy}) vs. Temperature, $V_{DD} = 3\text{ V}$

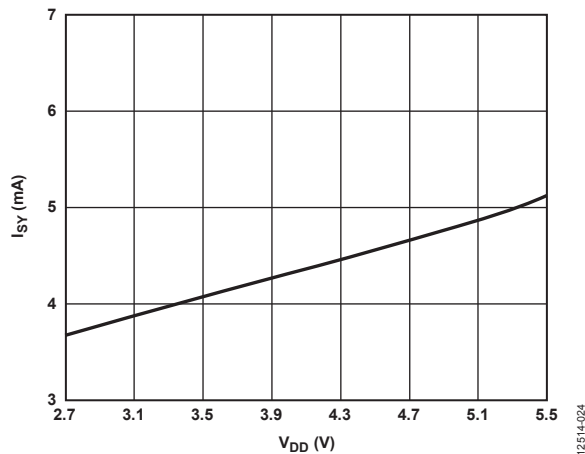

Figure 17. Supply Current (I_{Sy}) vs. Voltage (V_{DD}), $T = 25^\circ\text{C}$

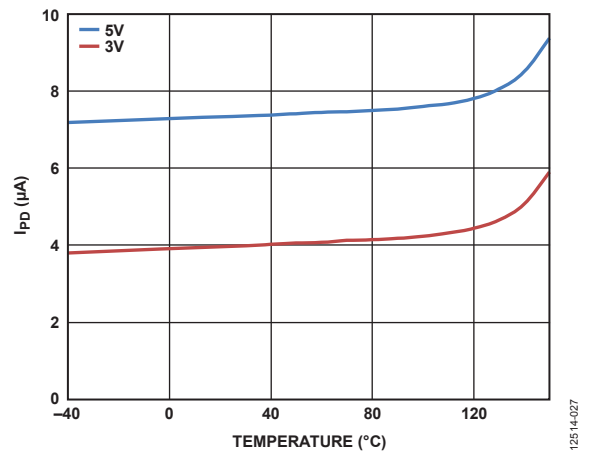

Figure 20. Power-Down Current (I_{PD}) vs. Temperature

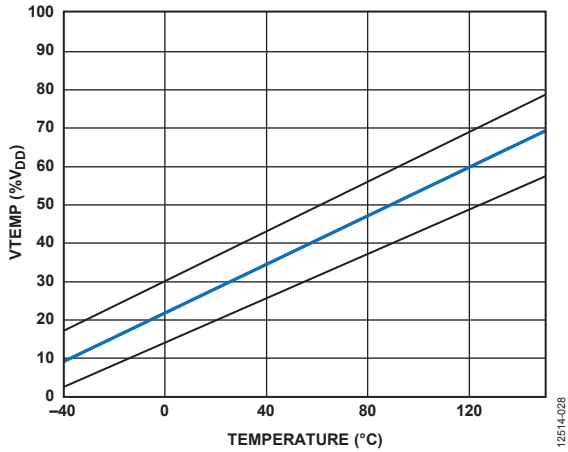

Figure 21. VTEMP Output Voltage vs. Temperature

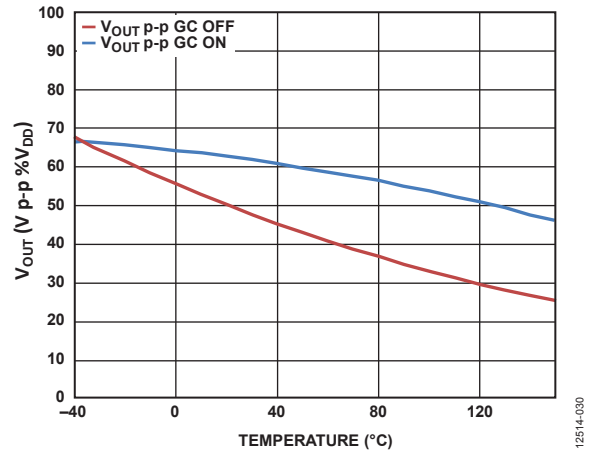

Figure 23. Output Voltage (V_{SIN} and V_{COS}) Peak-to-Peak vs. Temperature (% V_{DD})

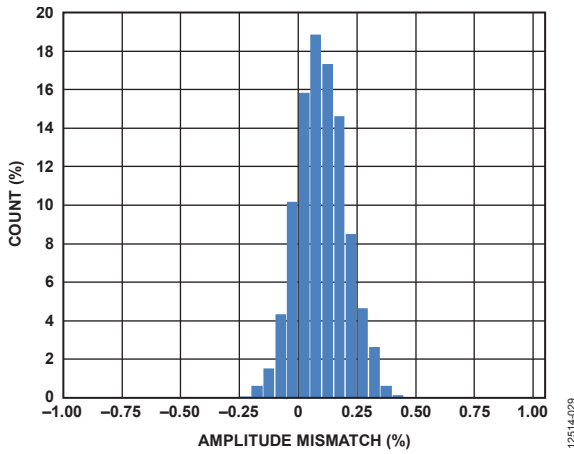

Figure 22. Amplitude Synchronism (% k)

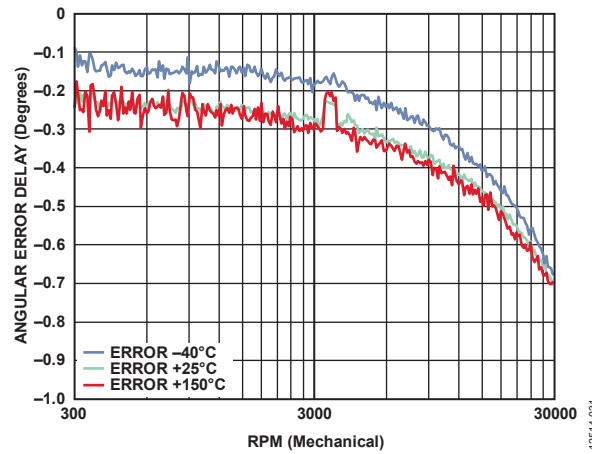

Figure 24. Angular Error Delay vs. RPM (Mechanical)

TERMINOLOGY

Reference Position Error

The reference position error is the absolute mounting position deviation of the sensor from its nominal placement. The reference position for $Y = 0 \mu\text{m}$ is the straight connection line of Pin 2 and Pin 7. The $X = 0 \mu\text{m}$ position is referred to the middle distance of the package top. The position accuracies are within a precision of $\pm 0.05 \text{ mm}$ ($\pm 50 \mu\text{m}$) in both the X and Y direction.

Reference Angle Error

The reference angle error is the absolute mounting rotation deviation of the sensor from its nominal placement. Marking the position for angle $\Phi = 0^\circ$ position is referred parallel to the straight connection line of Pin 2 and Pin 7.

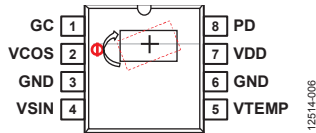

Figure 25. Bonding Arrangement and Sensor Alignment in Package

Output Amplitude Synchronism Error

The output amplitude matching error (k) is defined as the relationship between both output channel amplitudes at continuously rotating magnetic excitation of the MR sensor mathematically expressed as

$$k = 100\% \times V_{\text{SIN}_P-P} / V_{\text{COS}_P-P}$$

Uncorrected Angular Error

The uncorrected angular error is defined as the maximum deviation from an ideal angle reading, when calculating the angle from V_{SIN} and V_{COS} without offset calibration.

Single Point Calibration Angular Error

The single point calibration angular error is defined as the maximum deviation from an ideal angle reading, when calculating the angle from V_{SIN} and V_{COS} after an initial calibration for offset voltage at $T_A = 25^\circ\text{C}$.

Dynamic Angular Error

The dynamic angular error is defined as the maximum deviation from an ideal angle reading, when calculating the angle from V_{SIN} and V_{COS} while a continuous offset calibration is taken into account.

Phase Error

The phase error (Φ_{ERR}) is defined as the rotation frequency dependent error due to bandwidth limitation of the instrumentation amplifiers. V_{SIN} and V_{COS} are impacted by the amplifier propagation delay, referred to the actual angle direction of the rotating magnetic field. The typical characteristics value can be used for a first-order compensation of this error on very high rotations per minute. For low rotational speed systems, this error component is negligible and no compensation is necessary.

THEORY OF OPERATION

The ADA4571 is an AMR sensor with integrated signal conditioning amplifiers and ADC drivers. The ADA4571 produces two analog outputs, sine and cosine, which indicate the angular position of the surrounding magnetic field.

The AMR sensing element is designed and manufactured by Sensitec GmbH.

SENSITEC KÖRBER SOLUTIONS

Figure 27 shows the sine channel, consisting of an AMR sensor element and the supporting functions for control, filtering, buffering, and signal amplification. A reference voltage that is proportional to the supply voltage is generated and it controls the supply voltage of the sensor bridges. For noise and electromagnetic compatibility (EMC) suppression purposes, the bridge supply is low-pass filtered. The bridge output voltages are amplified by a constant factor ($G = 40$, GC mode disabled) and buffered. The single-ended outputs are biased around a common-mode voltage of $V_{DD}/2$ and are capable of driving the inputs of an external ADC referenced to the supply voltage.

For optimum use of the ADC input range, the cosine and sine output voltages track the supply voltage ensuring a ratiometric configuration. To achieve high signal performance both output signals are carefully matched in both amplitude and phase. The amplifier bandwidth is sufficient to ensure low phase delay at maximum specified rotation speed.

Electromagnetic interference (EMI) filters at the sensor outputs and between the first and second stages reject unwanted noise and interference from appearing in the signal band.

The architecture of the instrumentation amplifier consists of precision, low noise, zero drift amplifiers that feature a proprietary chopping technique. This chopping technique offers a low input offset voltage of $0.3 \mu\text{V}$ typical and an input offset voltage drift of $0.02 \mu\text{V}/^\circ\text{C}$ typical. The zero drift design also features chopping ripple suppression circuitry, which removes glitches and other artifacts caused by chopping.

Offset voltage errors caused by common-mode voltage swings and power supply variations are also corrected by the chopping technique, resulting in a dc common-mode rejection ratio that is greater than 150 dB. The amplifiers feature low broadband noise of $22 \text{ nV}/\sqrt{\text{Hz}}$ and no $1/f$ noise component. These features are ideal for amplification of the low level AMR bridge signals for high precision sensing applications.

In addition, extensive diagnostics are integrated on-chip to self check sensor and IC conditions.

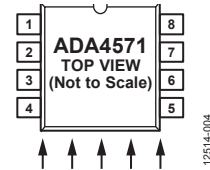

Figure 26. Direction of Homogeneous Magnetic Field for $\alpha = 0^\circ$

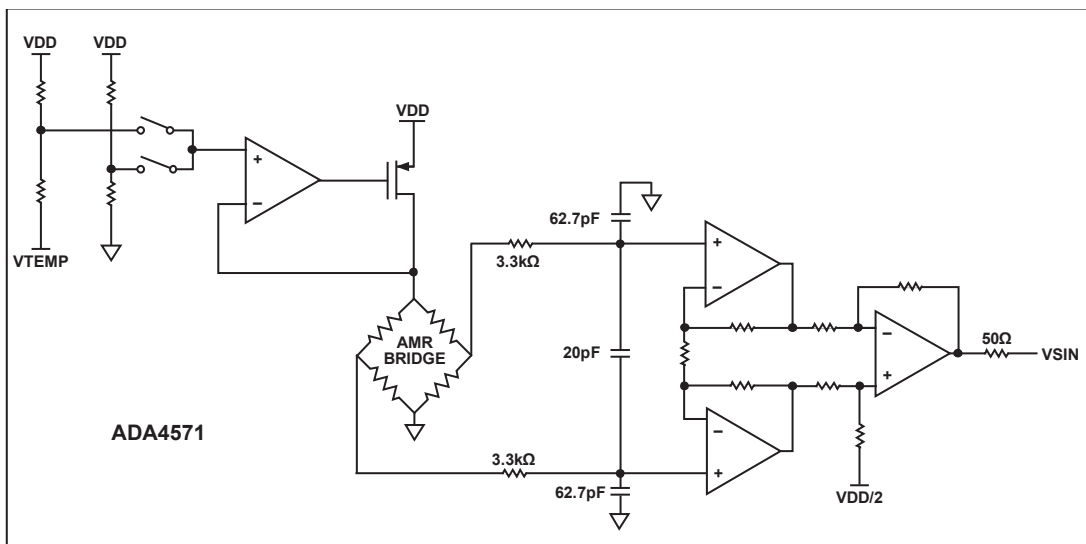
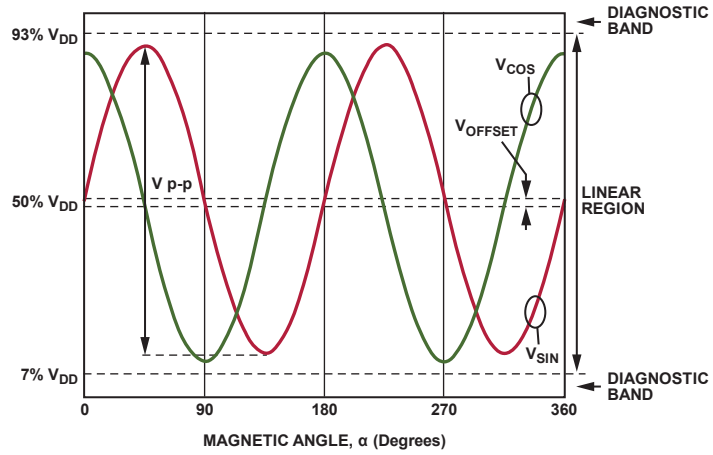

Figure 27. Detailed Internal Diagram of the ADA4571 Sine Channel



12514-003

Figure 28. Typical Output Waveforms; Sine and Cosine vs. Magnetic Angle

APPLICATIONS INFORMATION

The integrated AMR sensor is designed for applications with a separate processing IC or electronic control unit (ECU) containing an ADC with references connected to the supply voltage. With the ADC input resolution related to V_{DD} in the same way as the AMR sensor output, the system is inherently ratiometric and the signal dependency on supply voltage changes are minimized.

ANGLE CALCULATION

To calculate angle from the output of the AMR device, use the trigonometric function $\arctan2$. The $\arctan2$ function is a standard \arctan function with additional quadrant information to extend the output from the magnetic angle range of -90° to $+90^\circ$ to the magnetic angle range of -180° to $+180^\circ$. Because of the sensing range of AMR technology, this calculated magnetic angle repeats over each pole of the magnet. For a simple dipole magnet, the following equation reports absolute angle over 180° mechanical:

$$\alpha = \frac{\arctan\left(\frac{V_{SIN}}{V_{COS}}\right)}{2}$$

CONNECTION TO ECU

Because of the limited driving capability of the ADA4571 output, minimize the length of printed circuit board (PCB) traces between the ADA4571 and other IC. Shielding of the signal lines is recommended. Match the load capacitors and resistors for best angular accuracy. Add bandwidth limitation filters related to the sampling frequency of the system in front of the ADC inputs to reduce noise bandwidth.

In Figure 29, the load resistors on VCOS and VSIN are representing the input load of the filter and the ADC. The processor may be used for \arctan and offset calculations, offset storage, and additional calibration.

VTEMP Output Pin

A proportional to absolute temperature circuit provides a voltage output at the VTEMP pin for temperature monitoring or temperature calibration purposes. The output voltage is ratiometric to the supply voltage enabling the interface with an ADC that uses the supply voltage to generate the reference voltage. This pin must be left open when not in use.

To achieve maximum accuracy from the VTEMP output voltage, perform an initial calibration at a known, controlled temperature. Then, use the following equation to extract temperature information:

$$T_{VTEMP} = \frac{\left(\frac{V_{TEMP}}{V_{DD}}\right) - \left(\left(\frac{V_{CAL}}{V_{DD}}\right) - T_{CAL} \times T_{CO}\right)}{TC_{VTEMP}}$$

where:

T_{VTEMP} is the calculated temperature ($^\circ\text{C}$) from the VTEMP output voltage.

V_{TEMP} is the VTEMP output voltage during operation.

V_{DD} is the supply voltage.

V_{CAL} is the VTEMP output voltage during calibration at a controlled temperature.

T_{CAL} is the controlled temperature during calibration.

T_{CO} is the temperature coefficient of the internal circuit; see the Specifications section for the exact value.

Gain Control Mode

Gain control (GC) enable mode can be activated by switching the GC pin to the VDD pin. In this mode, the AMR bridge sensor amplitude outputs are compensated to reduce temperature variation. This results in higher and controlled output voltage levels, boosting system dynamic range and easing the system design task. If the GC pin is left floating, a weak pull-up resistor ensures that the GC mode is enabled as a default condition. The GC mode can also be used as a sensor self diagnostic by comparing the sine and cosine amplitude outputs when enabled and disabled, such as radius check. In the event that the radius does not change, it indicates a gross failure in the IC.

Power-Down Mode

Power-down mode can be activated by switching the PD pin to the VDD pin. Within this mode, the device shuts down and its output pins are set to high impedance to avoid current consumption across the load resistors. The VTEMP output is connected to ground through a pull-down resistor. Power-down mode can be entered with $GC = V_{DD}$ or $GC = GND$. An internal pull-down resistor ensures that the device remains active if the PD pin is left floating.

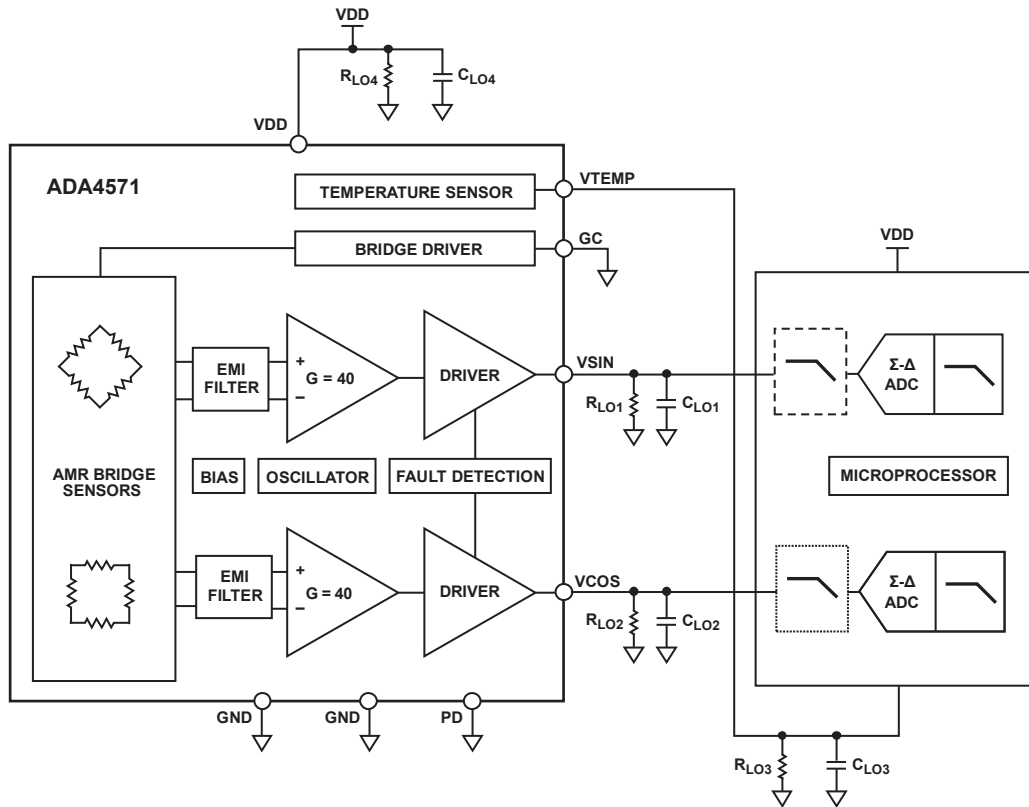

Figure 29. Typical Application Diagram with Separate Processor and Data Conversion

1.2514-007

Power Consumption

Worst case quiescent power occurs when the supply current runs at its specified maximum of 7 mA and the ADA4571 is run at the maximum V_{DD} of 5.5 V, giving a worst case quiescent power of 38.5 mW.

The power consumption is dependent on V_{DD} , temperature, load resistance (R_L), load capacitance (C_L), and frequency of the rotating magnetic field. It is recommended to refer R_L and C_L to ground. The output voltages are protected against short circuit to the V_{DD} pin or ground by current limitation within the given time duration. Placing the device 180° rotated into the socket may lead to damages if the supply current is not limited to 100 mA.

Offset of Signal Outputs

The single-ended output signals are referenced to $V_{DD}/2$ generated internally on-chip. Offsets originate from matching inaccuracies and other imperfections during the production process. For tight tolerances, it is required to match the external loads for VSIN and VCOS to each other. For ESD and EMC protection, the outputs contain a series resistance of 50 Ω. The influence of this series resistance is minimized with a large output load resistance.

Signal Dependence on Air Gap Distance

The IC measures the direction of the external magnetic field within its x-y plane. The result is widely independent of the field strength as long as it is above the specified minimum value of 25 kA/m. Within a homogeneous field in x-y direction, the result is independent of its placement in z direction (air gap). The nominal z distance of the internal x-y plane to the top surface of the plastic package is 0.400 mm.

MECHANICAL TOLERANCES DIAGRAMS

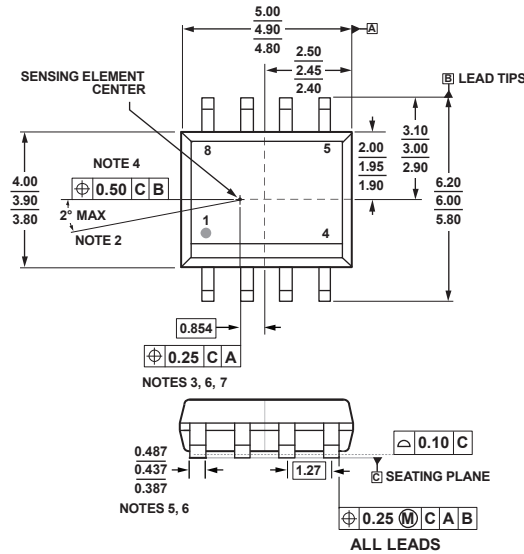

- NOTES
1. DIMENSIONS ARE IN MILLIMETERS.
 2. MAXIMUM SENSOR ROTATION.
 3. THIS DIMENSION AND TRUE POSITION SPECIFY THE LOCATION OF THE CENTER OF THE SENSING ELEMENT WITH RESPECT TO THE CENTER OF THE PACKAGE. THE CENTER OF THE SENSING ELEMENT IS ALIGNED WITH THE EDGES OF LEAD 2 AND LEAD 7.
 4. THE CENTER OF THE SENSING ELEMENT IS ALIGNED WITH THE CENTER LINE OF THE PACKAGE (DATUM B).
 5. THE LEAD WIDTH DIMENSION IS TOLERANCED MORE TIGHTLY THAN ON THE R8 PACKAGE OUTLINE DRAWING. THIS DIMENSION IS MEASURED AT THE FOOT OF THE LEAD (NO FLASH, BURRS).
 6. DOES NOT INCLUDE MOLD FLASH, DAMBAR PROTRUSIONS, OR BURRS.
 7. MOLD BODY WIDTH AND LENGTH DIMENSIONS DO NOT INCLUDE MOLD FLASH, OFFSETS, OR MOLD GATE PROTRUSIONS.
 8. REFER TO THE R8 PACKAGE OUTLINE DRAWING FOR DIMENSIONS NOT SHOWN HERE.

Figure 30. Mechanical Drawing of the ADA4571

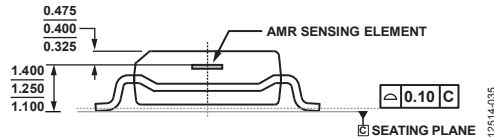

Figure 31. Cross Sectional View of the ADA4571

DIAGNOSTICS

Radius Calculation

The V_{SIN} and V_{COS} outputs can be used to calculate a radius value. These outputs have a fixed 90° phase relationship and therefore the calculated radius value remains in a predictable, predetermined range that varies with the temperature of the device independent of the current magnetic field direction. This radius, V_{RAD} , can be used to validate the V_{SIN} and V_{COS} readings in the ECU. When the calculated radius is no longer within the acceptable bounds, a fault may occur in the system. To calculate radius, use the following formula:

$$V_{RAD} = \sqrt{(V_{SIN} - \frac{V_{DD}}{2})^2 + (V_{COS} - \frac{V_{DD}}{2})^2}$$

It is important to perform offset calibration before calculating the radius.

Figure 32 shows the allowable radius values when GC mode is enabled and Figure 33 shows the allowable radius values when GC mode is disabled. The maximum and minimum V_{RAD} values are calculated based on the allowable amplitude range for V_{SIN} and V_{COS} , over the entire operating temperature of the device as specified in the Specifications section. This range is represented by the shaded region in Figure 32 and Figure 33.

Typical V_{RAD} values for -40°C, +25°C, +125°C, and +150°C are indicated as well.

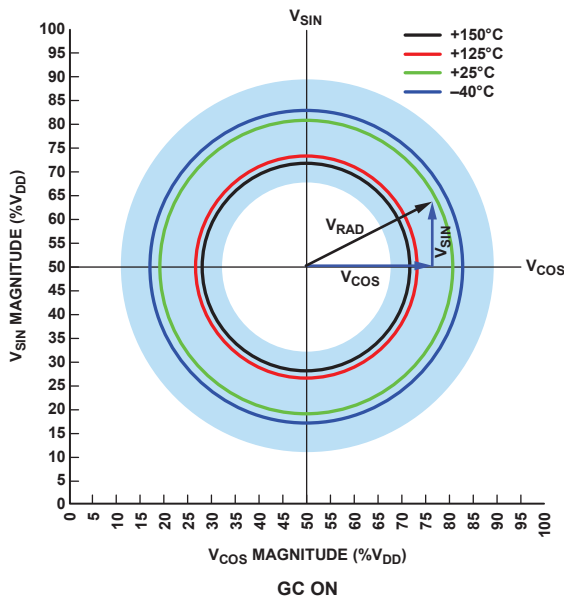

Figure 32. GC On Radius Values

12514-101

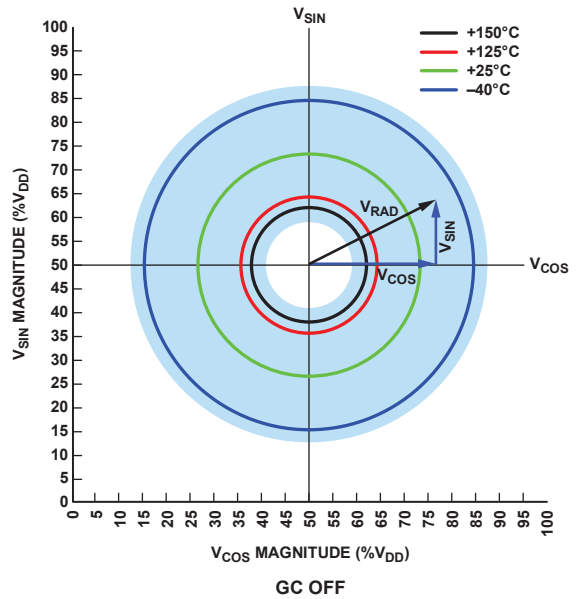

Figure 33. GC Off Radius Values

12514-100

Monitoring of the VTEMP pin can allow an even tighter range for radius length at the known temperature. See the Specifications section and the Typical Performance Characteristics section for exact values and output amplitude specifications at each temperature.

Broken Bond Wire Detection

The ADA4571 includes circuitry to detect broken bond wire conditions between the AMR sensor and the instrumentation amplifier. The detection circuitry consists of current sources and window comparators placed on the signal connections between the AMR sensor and the ASIC. The purpose of the current sources is to pull the signal node outside of the normal operating region in the event of an open bond wire between the AMR sensor and the ASIC. The purpose of the window comparators is to detect when the signal from the AMR sensor is outside of the normal operating region. When the comparators detect that the signal nodes are outside the normal operating region, the circuit pulls the VSIN and/or VCOS node to ground to indicate the fault to the host controller.

In addition to the active circuitry, there are applications recommendations, such as the utilization of pull-up and pull-down resistors, which detect broken bond wires by pulling nodes outside of the defined operating regions. A broken bond wire at VTEMP, VCOS, and VSIN interrupts the corresponding outputs. To ensure that the output enters into a known state if there is a broken bond wire on these pins, connect a 200 kΩ pull-down resistor at these pins. Pulling these nodes outside of the normal operating region signals a fault to the host controller.

Short-Circuit Condition to GND or VDD

In the event of a short-circuit condition, the output voltages are pulled to the GND or VDD pin.

Short-Circuit Between Sine and Cosine Sensor Outputs

In the event of a short-circuit between sensor outputs, the IC output voltages are tied to the output common-mode voltage. A gross angular error is detected in the microcontroller.

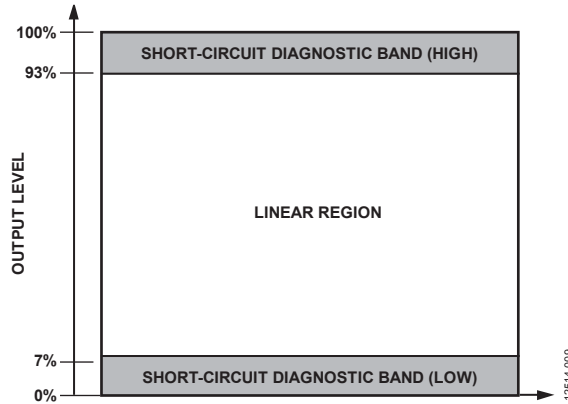
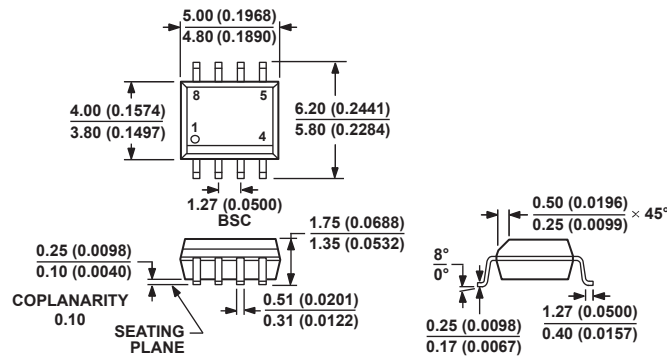

Figure 34. Output Span Classification During Short-Circuit Diagnostic Condition

Table 7. Diagnostic Cases

Fault Description	Output Conditions	Alert
Broken Bond Wire Between the Internal MR Sensor and the ASIC	Broken bond wire detection is activated; the broken channel(s), VSIN or VCOS, are pulled to ground	Diagnostic region violation
Broken Bond Wire at the PD Pin	Device remains functional	No alert
Broken Bond Wire at the GC Pin	Gain control is activated	Possible change in output amplitude
Output Short-Circuit to GND	Shorted channel is pulled to ground	Diagnostic region violation
Output Short-Circuit to VDD	Shorted channel is pulled to VDD	Diagnostic region violation

OUTLINE DIMENSIONS



COMPLIANT TO JEDEC STANDARDS MS-012-AA
 CONTROLLING DIMENSIONS ARE IN MILLIMETERS; INCH DIMENSIONS (IN PARENTHESES) ARE ROUNDED-OFF MILLIMETER EQUIVALENTS FOR REFERENCE ONLY AND ARE NOT APPROPRIATE FOR USE IN DESIGN.

012407-A

Figure 35. 8-Lead Standard Small Outline Package [SOIC_N] Narrow Body (R-8)

Dimensions shown in millimeters and (inches)

ORDERING GUIDE

Model ^{1,2}	Temperature Range	Package Description	Package Option
ADA4571WHRZ-R7	-40°C to +150°C	8-Lead SOIC_N, 7" Tape and Reel	R-8
ADA4571BRZ	-40°C to +125°C	8-Lead SOIC_N	R-8
ADA4571BRZ-RL	-40°C to +125°C	8-Lead SOIC_N, 13" Tape and Reel	R-8
ADA4571BRZ-R7	-40°C to +125°C	8-Lead SOIC_N, 7" Tape and Reel	R-8

¹ Z = RoHS Compliant Part.

² W = Qualified for Automotive Applications.

AUTOMOTIVE PRODUCTS

The ADA4571WHRZ model is available with controlled manufacturing to support the quality and reliability requirements of automotive applications. Note that this automotive model may have specifications that differ from the commercial models; therefore, designers should review the Specifications section of this data sheet carefully. Only the automotive grade products shown are available for use in automotive applications. Contact your local Analog Devices account representative for specific product ordering information and to obtain the specific Automotive Reliability reports for these models.

X-ON Electronics

Largest Supplier of Electrical and Electronic Components

Click to view similar products for [Board Mount Hall Effect/Magnetic Sensors](#) category:

Click to view products by [Analog Devices](#) manufacturer:

Other Similar products are found below :

[HGPRDT005A](#) [AH277AZ4-AG1](#) [AV-10379](#) [AV-10448](#) [SS41C](#) [AH1894-Z-7](#) [ATS601LSGTN-LT-WU4-T](#) [TLE4917](#) [50017859-003](#) [TY-13101](#) [TLE4976L](#) [AH49FNTR-G1](#) [SS85CA](#) [AH277AZ4-BG1](#) [TLE49614MXTSA1](#) [AH3377-P-B](#) [AH211Z4-AG1](#) [AH3360-FT4-7](#) [SS460S-100SAMPLE](#) [50065820-03](#) [TLE4941PLUSCB](#) [AH374-P-A](#) [AH1806-P-A](#) [AH374-W-7](#) [SS460P-T2](#) [AH1913-W-7](#) [SS413F](#)
[TLE5046ICAKLRHALA1](#) [TLE49421CHAMA2](#) [TLE4941PLUSCXAMA1](#) [AH1912-W-EVM](#) [AH1903-FA-EVM](#) [AH3774-W-EVM](#)
[AH49FNTR-EVM](#) [MMC5633NJL](#) [AH3360-FA-EVM](#) [AH8502-FDC-EVM](#) [AH3366Q-SA-EVM](#) [AH3774-P-EVM](#) [KTH1601SU-ST3](#)
[MG910](#) [MG910M](#) [MG911](#) [MG610](#) [MW921](#) [MW922](#) [TLE4998S3XALA1](#) [TLE5011FUMA1](#) [TLE5027CE6747HAMA1](#)
[TLE5109A16E2210XUMA1](#)