

FEATURES

- Low wideband noise**
 - 1 nV/ $\sqrt{\text{Hz}}$
 - 2.8 pA/ $\sqrt{\text{Hz}}$
- Low 1/f noise: 2.4 nV/ $\sqrt{\text{Hz}}$ at 10 Hz**
- Low distortion: -115 dBc at 100 kHz, $V_{\text{OUT}} = 2 \text{ V p-p}$**
- Low power: 3 mA per amplifier**
- Low input offset voltage: 0.5 mV maximum**
- High speed**
 - 3 dB bandwidth: 230 MHz ($G = +1$)
 - Slew rate: 120 V/ μs
 - Settling time to 0.1%: 45 ns
- Rail-to-rail output**
- Wide supply range: 3 V to 10 V**
- Disable feature (ADA4897-1/ADA4897-2)**

APPLICATIONS

- Low noise preamplifier
- Ultrasound amplifiers
- PLL loop filters
- High performance ADC drivers
- DAC buffers

GENERAL DESCRIPTION

The ADA4896-2/ADA4897-1/ADA4897-2 are unity-gain stable, low noise, rail-to-rail output, high speed voltage feedback amplifiers that have a quiescent current of 3 mA. With a 1/f noise of 2.4 nV/ $\sqrt{\text{Hz}}$ at 10 Hz and a spurious-free dynamic range of -80 dBc at 2 MHz, the ADA4896-2/ADA4897-1/ADA4897-2 are ideal solutions in a variety of applications, including ultrasound, low noise preamplifiers, and drivers of high performance ADCs. The Analog Devices, Inc., proprietary next-generation SiGe bipolar process and innovative architecture enable such high performance amplifiers.

The ADA4896-2/ADA4897-1/ADA4897-2 have 230 MHz bandwidth, 120 V/ μs slew rate, and settle to 0.1% in 45 ns. With a wide supply voltage range of 3 V to 10 V, the ADA4896-2/ADA4897-1/ADA4897-2 are ideal candidates for systems that require high dynamic range, precision, low power, and high speed.

The ADA4896-2 is available in 8-lead LFCSP and 8-lead MSOP packages. The ADA4897-1 is available in 8-lead SOIC and 6-lead SOT-23 packages. The ADA4897-2 is available in a 10-lead MSOP package. The ADA4896-2/ADA4897-1/ADA4897-2 operate over the extended industrial temperature range of -40°C to +125°C.

Rev. B

Information furnished by Analog Devices is believed to be accurate and reliable. However, no responsibility is assumed by Analog Devices for its use, nor for any infringements of patents or other rights of third parties that may result from its use. Specifications subject to change without notice. No license is granted by implication or otherwise under any patent or patent rights of Analog Devices. Trademarks and registered trademarks are the property of their respective owners.

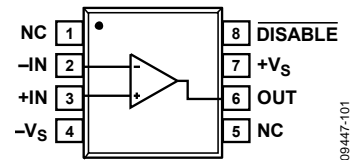
FUNCTIONAL BLOCK DIAGRAM


Figure 1. 8-Lead SOIC (ADA4897-1)

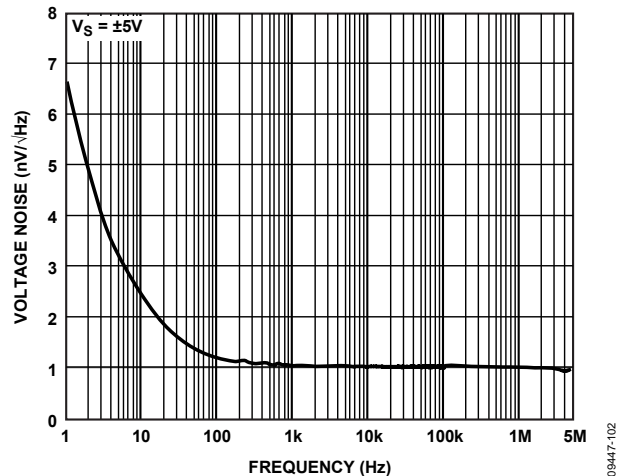


Figure 2. Voltage Noise vs. Frequency

Table 1. Other Low Noise Amplifiers

Part No.	V_N (nV/ $\sqrt{\text{Hz}}$)		BW (MHz)	Supply Voltage (V)
	At 1 kHz	At 100 kHz		
AD797	0.9	0.9	8	10 to 30
AD8021	5	2.1	490	5 to 24
AD8099	3	0.95	510	5 to 12
AD8045	6	3	1000	3.3 to 12
ADA4899-1	1.4	1	600	5 to 12
ADA4898-1/ ADA4898-2	0.9	0.9	65	10 to 32

Table 2. Complementary ADCs

Part No.	Bits	Speed (MSPS)	Power (mW)
AD7944	14	2.5	15.5
AD7985	16	2.5	15.5
AD7986	18	2	15

TABLE OF CONTENTS

Features 1
 Applications..... 1
 General Description 1
 Functional Block Diagram 1
 Revision History 2
 Specifications..... 3
 ±5 V Supply 3
 +5 V Supply 4
 +3 V Supply 6
 Absolute Maximum Ratings..... 8
 Thermal Resistance 8
 Maximum Power Dissipation 8
 ESD Caution..... 8
 Pin Configurations and Function Descriptions 9
 Typical Performance Characteristics 11

REVISION HISTORY

4/12—Rev. A to Rev. B

Changed 6-Lead Single SOT-23 (ADA4897-1) Thermal
 Resistance from 306°C/W to 150°C/W 8
 Changes to Figure 3..... 8

10/11—Rev. 0 to Rev. A

Added ADA4897-2 and 10-Lead MSOP Universal
 Change to Table 1 1
 Changes to Table 3..... 3
 Changes to Table 4..... 4
 Changes to Table 5..... 6
 Changes to Table 7 and Figure 3..... 8
 Changes to Figure 4, Table 8, and Table 9 9
 Added Figure 8 and Table 10; Renumbered Sequentially 10
 Changed Summary Statement for Typical Performance
 Characteristics Section..... 11
 Changes to Figure 18..... 12
 Change to Figure 20 12

Theory of Operation 17
 Amplifier Description..... 17
 Input Protection 17
 Disable Operation 17
 DC Errors 18
 Bias Current Cancellation 18
 Noise Considerations..... 19
 Capacitance Drive 19
 Applications Information 20
 Typical Performance Values..... 20
 Low Noise, Gain Selectable Amplifier..... 21
 Medical Ultrasound Applications 22
 Layout Considerations..... 24
 Outline Dimensions..... 25
 Ordering Guide 27

Change to Figure 26; Moved Figure 26..... 13
 Changes to Figure 37..... 15

Changes to Amplifier Description Section, Disable Operation
 Section, Figure 44, and Figure 45 17
 Added Bias Current Cancellation Section, Figure 47,
 Table 11, and Table 12..... 18
 Changes to Table 13 20
 Changes to Low Noise, Gain Selectable Amplifier Section
 and Figure 52..... 21
 Deleted Figure 51..... 22
 Changes to Power Supply Bypassing Section 24
 Moved Figure 57 25
 Moved Figure 58 26
 Added Figure 60 27
 Changes to Ordering Guide 27

7/11—Revision 0: Initial Version

SPECIFICATIONS

±5 V SUPPLY

$T_A = 25^\circ\text{C}$, $G = +1$, $R_L = 1\text{ k}\Omega$ to ground, unless otherwise noted.

Table 3.

Parameter	Test Conditions/Comments	Min	Typ	Max	Unit
DYNAMIC PERFORMANCE					
-3 dB Bandwidth	$G = +1$, $V_{OUT} = 0.02\text{ V p-p}$		230		MHz
	$G = +1$, $V_{OUT} = 2\text{ V p-p}$		30		MHz
Bandwidth for 0.1 dB Flatness	$G = +2$, $V_{OUT} = 0.02\text{ V p-p}$		90		MHz
	$G = +2$, $V_{OUT} = 2\text{ V p-p}$, $R_L = 100\ \Omega$		7		MHz
Slew Rate	$G = +2$, $V_{OUT} = 6\text{ V step}$		120		V/ μs
Settling Time to 0.1%	$G = +2$, $V_{OUT} = 2\text{ V step}$		45		ns
Settling Time to 0.01%	$G = +2$, $V_{OUT} = 2\text{ V step}$		90		ns
NOISE/HARMONIC PERFORMANCE					
Harmonic Distortion (SFDR)	$V_{OUT} = 2\text{ V p-p}$				
	$f_C = 100\text{ kHz}$		-115		dBc
	$f_C = 1\text{ MHz}$		-93		dBc
	$f_C = 2\text{ MHz}$		-80		dBc
	$f_C = 5\text{ MHz}$		-61		dBc
Input Voltage Noise	$f = 10\text{ Hz}$		2.4		nV/ $\sqrt{\text{Hz}}$
	$f = 100\text{ kHz}$		1		nV/ $\sqrt{\text{Hz}}$
Input Current Noise	$f = 10\text{ Hz}$		11		pA/ $\sqrt{\text{Hz}}$
	$f = 100\text{ kHz}$		2.8		pA/ $\sqrt{\text{Hz}}$
0.1 Hz to 10 Hz Noise	$G = +101$, $R_F = 1\text{ k}\Omega$, $R_G = 10\ \Omega$		99		nV p-p
DC PERFORMANCE					
Input Offset Voltage		-500	-28	+500	μV
Input Offset Voltage Drift			0.2		$\mu\text{V}/^\circ\text{C}$
Input Bias Current		-17	-11	-4	μA
Input Bias Current Drift			3		nA/ $^\circ\text{C}$
Input Bias Offset Current		-0.6	-0.02	+0.6	μA
Open-Loop Gain	$V_{OUT} = -4\text{ V to }+4\text{ V}$	100	110		dB
INPUT CHARACTERISTICS					
Input Resistance					
	Common-Mode		10		M Ω
Differential			10		k Ω
Input Capacitance					
	Common-Mode		3		pF
Differential			11		pF
Input Common-Mode Voltage Range			-4.9 to +4.1		V
Common-Mode Rejection Ratio (CMRR)	$V_{CM} = -2\text{ V to }+2\text{ V}$	-92	-120		dB
OUTPUT CHARACTERISTICS					
Output Overdrive Recovery Time	$V_{IN} = \pm 5\text{ V}$, $G = +2$		81		ns
Output Voltage Swing					
	Positive	$R_L = 1\text{ k}\Omega$	4.85	4.96	V
	$R_L = 100\ \Omega$	4.5	4.73		V
Negative	$R_L = 1\text{ k}\Omega$	-4.85	-4.97		V
	$R_L = 100\ \Omega$	-4.5	-4.84		V
Output Current	SFDR = -45 dBc		80		mA
Short-Circuit Current	Sinking/sourcing		135		mA
Capacitive Load Drive	30% overshoot, $G = +2$		39		pF

Parameter	Test Conditions/Comments	Min	Typ	Max	Unit
POWER SUPPLY					
Operating Range			3 to 10		V
Quiescent Current per Amplifier		2.8	3.0	3.2	mA
	$\overline{\text{DISABLE}} = -5\text{ V}$		0.13	0.25	mA
Power Supply Rejection Ratio (PSRR)					
Positive	$+V_S = 4\text{ V to }6\text{ V}, -V_S = -5\text{ V}$	-96	-125		dB
Negative	$+V_S = 5\text{ V}, -V_S = -4\text{ V to }-6\text{ V}$	-96	-121		dB
DISABLE PIN (ADA4897-1/ADA4897-2)					
DISABLE Voltage	Enabled		$>+V_S - 0.5$		V
	Disabled		$<+V_S - 2$		V
Input Current					
Enabled	$\overline{\text{DISABLE}} = +5\text{ V}$		-1.2		μA
Disabled	$\overline{\text{DISABLE}} = -5\text{ V}$		-40		μA
Switching Speed					
Enabled			0.25		μs
Disabled			12		μs

+5 V SUPPLY

$T_A = 25^\circ\text{C}$, $G = +1$, $R_L = 1\text{ k}\Omega$ to midsupply, unless otherwise noted.

Table 4.

Parameter	Test Conditions/Comments	Min	Typ	Max	Unit
DYNAMIC PERFORMANCE					
-3 dB Bandwidth	$G = +1, V_{OUT} = 0.02\text{ V p-p}$		230		MHz
	$G = +1, V_{OUT} = 2\text{ V p-p}$		30		MHz
	$G = +2, V_{OUT} = 0.02\text{ V p-p}$		90		MHz
Bandwidth for 0.1 dB Flatness	$G = +2, V_{OUT} = 2\text{ V p-p}, R_L = 100\ \Omega$		7		MHz
Slew Rate	$G = +2, V_{OUT} = 3\text{ V step}$		100		$\text{V}/\mu\text{s}$
Settling Time to 0.1%	$G = +2, V_{OUT} = 2\text{ V step}$		45		ns
Settling Time to 0.01%	$G = +2, V_{OUT} = 2\text{ V step}$		95		ns
NOISE/HARMONIC PERFORMANCE					
Harmonic Distortion (SFDR)	$V_{OUT} = 2\text{ V p-p}$				
	$f_C = 100\text{ kHz}$		-115		dBc
	$f_C = 1\text{ MHz}$		-93		dBc
	$f_C = 2\text{ MHz}$		-80		dBc
	$f_C = 5\text{ MHz}$		-61		dBc
Input Voltage Noise	$f = 10\text{ Hz}$		2.4		$\text{nV}/\sqrt{\text{Hz}}$
	$f = 100\text{ kHz}$		1		$\text{nV}/\sqrt{\text{Hz}}$
Input Current Noise	$f = 10\text{ Hz}$		11		$\text{pA}/\sqrt{\text{Hz}}$
	$f = 100\text{ kHz}$		2.8		$\text{pA}/\sqrt{\text{Hz}}$
0.1 Hz to 10 Hz Noise	$G = +101, R_F = 1\text{ k}\Omega, R_G = 10\ \Omega$		99		nV p-p
DC PERFORMANCE					
Input Offset Voltage		-500	-30	+500	μV
Input Offset Voltage Drift			0.2		$\mu\text{V}/^\circ\text{C}$
Input Bias Current		-17	-11	-4	μA
Input Bias Current Drift			3		$\text{nA}/^\circ\text{C}$
Input Bias Offset Current		-0.6	-0.02	+0.6	μA
Open-Loop Gain	$V_{OUT} = 0.5\text{ V to }4.5\text{ V}$	97	110		dB

Parameter	Test Conditions/Comments	Min	Typ	Max	Unit
INPUT CHARACTERISTICS					
Input Resistance					
Common-Mode			10		M Ω
Differential			10		k Ω
Input Capacitance					
Common-Mode			3		pF
Differential			11		pF
Input Common-Mode Voltage Range			0.1 to 4.1		V
Common-Mode Rejection Ratio (CMRR)	$V_{CM} = 1\text{ V to }4\text{ V}$	-91	-118		dB
OUTPUT CHARACTERISTICS					
Output Overdrive Recovery Time	$V_{IN} = 0\text{ V to }5\text{ V}, G = +2$		96		ns
Output Voltage Swing					
Positive	$R_L = 1\text{ k}\Omega$	4.85	4.98		V
	$R_L = 100\ \Omega$	4.8	4.88		V
Negative	$R_L = 1\text{ k}\Omega$	0.15	0.014		V
	$R_L = 100\ \Omega$	0.2	0.08		V
Output Current	SFDR = -45 dBc		70		mA
Short-Circuit Current	Sinking/sourcing		125		mA
Capacitive Load Drive	30% overshoot, $G = +2$		39		pF
POWER SUPPLY					
Operating Range			3 to 10		V
Quiescent Current per Amplifier		2.6	2.8	2.9	mA
	$\overline{\text{DISABLE}} = 0\text{ V}$		0.05	0.18	mA
Power Supply Rejection Ratio (PSRR)					
Positive	$+V_S = 4.5\text{ V to }5.5\text{ V}, -V_S = 0\text{ V}$	-96	-123		dB
Negative	$+V_S = 5\text{ V}, -V_S = -0.5\text{ V to }+0.5\text{ V}$	-96	-121		dB
DISABLE PIN (ADA4897-1/ADA4897-2)					
DISABLE Voltage	Enabled		$>+V_S - 0.5$		V
	Disabled		$<+V_S - 2$		V
Input Current					
Enabled	$\overline{\text{DISABLE}} = +5\text{ V}$		-1.2		μA
Disabled	$\overline{\text{DISABLE}} = 0\text{ V}$		-20		μA
Switching Speed					
Enabled			0.25		μs
Disabled			12		μs

+3 V SUPPLY

T_A = 25°C, G = +1, R_L = 1 kΩ to midsupply, unless otherwise noted.

Table 5.

Parameter	Test Conditions/Comments	Min	Typ	Max	Unit
DYNAMIC PERFORMANCE					
-3 dB Bandwidth	G = +1, V _{OUT} = 0.02 V p-p		230		MHz
	G = -1, V _{OUT} = 1 V p-p		45		MHz
	G = +2, V _{OUT} = 0.02 V p-p		90		MHz
Bandwidth for 0.1 dB Flatness	G = +2, V _{OUT} = 2 V p-p, R _L = 100 Ω		7		MHz
Slew Rate	G = +2, V _{OUT} = 1 V step		85		V/μs
Settling Time to 0.1%	G = +2, V _{OUT} = 2 V step		45		ns
Settling Time to 0.01%	G = +2, V _{OUT} = 2 V step		96		ns
NOISE/HARMONIC PERFORMANCE					
Harmonic Distortion (SFDR)	f _C = 100 kHz, V _{OUT} = 2 V p-p, G = +2		-105		dBc
	f _C = 1 MHz, V _{OUT} = 1 V p-p, G = -1		-84		dBc
	f _C = 2 MHz, V _{OUT} = 1 V p-p, G = -1		-77		dBc
	f _C = 5 MHz, V _{OUT} = 1 V p-p, G = -1		-60		dBc
Input Voltage Noise	f = 10 Hz		2.3		nV/√Hz
	f = 100 kHz		1		nV/√Hz
Input Current Noise	f = 10 Hz		11		pA/√Hz
	f = 100 kHz		2.8		pA/√Hz
0.1 Hz to 10 Hz Noise	G = +101, R _F = 1 kΩ, R _G = 10 Ω		99		nV p-p
DC PERFORMANCE					
Input Offset Voltage		-500	-30	+500	μV
Input Offset Voltage Drift			0.2		μV/°C
Input Bias Current		-17	-11	-4	μA
Input Bias Current Drift			3		nA/°C
Input Bias Offset Current		-0.6	-0.02	+0.6	μA
Open-Loop Gain	V _{OUT} = 0.5 V to 2.5 V	95	108		dB
INPUT CHARACTERISTICS					
Input Resistance			10		MΩ
			10		kΩ
Input Capacitance			3		pF
			11		pF
Input Common-Mode Voltage Range			0.1 to 2.1		V
Common-Mode Rejection Ratio (CMRR)	V _{CM} = 1.1 V to 1.9 V	-90	-124		dB
OUTPUT CHARACTERISTICS					
Output Overdrive Recovery Time	V _{IN} = 0 V to 3 V, G = +2		83		ns
Output Voltage Swing	Positive	R _L = 1 kΩ	2.85	2.97	V
		R _L = 100 Ω	2.8	2.92	V
	Negative	R _L = 1 kΩ	0.15	0.01	V
		R _L = 100 Ω	0.2	0.05	V
Output Current	SFDR = -45 dBc		60		mA
Short-Circuit Current	Sinking/sourcing		120		mA
Capacitive Load Drive	30% overshoot, G = +2		39		pF
POWER SUPPLY					
Operating Range			3 to 10		V
Quiescent Current per Amplifier		2.5	2.7	2.9	mA
	<u>DISABLE</u> = 0 V		0.035	0.15	mA

Parameter	Test Conditions/Comments	Min	Typ	Max	Unit
Power Supply Rejection Ratio (PSRR)					
Positive	$+V_S = 2.7\text{ V to }3.7\text{ V}, -V_S = 0\text{ V}$	-96	-121		dB
Negative	$+V_S = 3\text{ V}, -V_S = -0.3\text{ V to }+0.7\text{ V}$	-96	-120		dB
DISABLE PIN (ADA4897-1/ADA4897-2)					
DISABLE Voltage	Enabled		$>+V_S - 0.5$		V
	Disabled		$<-V_S + 2$		V
Input Current					
Enabled	$\overline{\text{DISABLE}} = +3\text{ V}$		-1.2		μA
Disabled	$\overline{\text{DISABLE}} = 0\text{ V}$		-15		μA
Switching Speed					
Enabled			0.25		μs
Disabled			12		μs

ABSOLUTE MAXIMUM RATINGS

Table 6.

Parameter	Rating
Supply Voltage	11 V
Power Dissipation	See Figure 3
Common-Mode Input Voltage	-V _S - 0.7 V to +V _S + 0.7 V
Differential Input Voltage	±0.7 V
Storage Temperature Range	-65°C to +125°C
Operating Temperature Range	-40°C to +125°C
Lead Temperature (Soldering 10 sec)	300°C
Junction Temperature	150°C

Stresses above those listed under Absolute Maximum Ratings may cause permanent damage to the device. This is a stress rating only; functional operation of the device at these or any other conditions above those indicated in the operational section of this specification is not implied. Exposure to absolute maximum rating conditions for extended periods may affect device reliability.

THERMAL RESISTANCE

θ_{JA} is specified for the worst-case conditions, that is, θ_{JA} is specified for a device soldered in a circuit board for surface-mount packages. Table 7 lists the θ_{JA} for the [ADA4896-2/ADA4897-1/ADA4897-2](#).

Table 7. Thermal Resistance

Package Type	θ _{JA}	Unit
8-Lead Dual MSOP (ADA4896-2)	222	°C/W
8-Lead Dual LFCSP (ADA4896-2)	61	°C/W
8-Lead Single SOIC (ADA4897-1)	133	°C/W
6-Lead Single SOT-23 (ADA4897-1)	150	°C/W
10-Lead Dual MSOP (ADA4897-2)	210	°C/W

MAXIMUM POWER DISSIPATION

The maximum safe power dissipation for the [ADA4896-2/ADA4897-1/ADA4897-2](#) is limited by the associated rise in junction temperature (T_J) on the die. At approximately 150°C, which is the glass transition temperature, the properties of the plastic change. Even temporarily exceeding this temperature limit may change the stresses that the package exerts on the die, permanently shifting the parametric performance of the [ADA4896-2/ADA4897-1/ADA4897-2](#). Exceeding a junction temperature of 175°C for an extended period of time can result in changes in silicon devices, potentially causing degradation or loss of functionality.

The power dissipated in the package (P_D) is the sum of the quiescent power dissipation and the power dissipated in the die due to the [ADA4896-2/ADA4897-1/ADA4897-2](#) drive at the output.

The quiescent power dissipation is the voltage between the supply pins (±V_S) multiplied by the quiescent current (I_S).

$$P_D = \text{Quiescent Power} + (\text{Total Drive Power} - \text{Load Power})$$

$$P_D = (V_S \times I_S) + \left(\frac{V_S}{2} \times \frac{V_{OUT}}{R_L} \right) - \frac{V_{OUT}^2}{R_L}$$

RMS output voltages should be considered. If R_L is referenced to -V_S, as in single-supply operation, the total drive power is V_S × I_{OUT}. If the rms signal levels are indeterminate, consider the worst case, when V_{OUT} = V_S/4 for R_L to midsupply.

$$P_D = (V_S \times I_S) + \frac{(V_S / 4)^2}{R_L}$$

In single-supply operation with R_L referenced to -V_S, worst case is V_{OUT} = V_S/2.

Airflow increases heat dissipation, effectively reducing θ_{JA}. Also, more metal directly in contact with the package leads and exposed paddle from metal traces, through holes, ground, and power planes reduces θ_{JA}.

Figure 3 shows the maximum safe power dissipation in the package vs. the ambient temperature on a JEDEC standard 4-layer board. θ_{JA} values are approximations.



Figure 3. Maximum Power Dissipation vs. Temperature for a 4-Layer Board

ESD CAUTION



ESD (electrostatic discharge) sensitive device. Charged devices and circuit boards can discharge without detection. Although this product features patented or proprietary protection circuitry, damage may occur on devices subjected to high energy ESD. Therefore, proper ESD precautions should be taken to avoid performance degradation or loss of functionality.

PIN CONFIGURATIONS AND FUNCTION DESCRIPTIONS



NOTES
 1. THE EXPOSED PAD CAN BE CONNECTED TO GND OR POWER PLANES, OR IT CAN BE LEFT FLOATING.

09447-022

Figure 4. 8-Lead LFCSP Pin Configuration

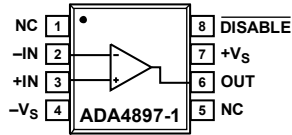


09447-022

Figure 5. 8-Lead MSOP Pin Configuration

Table 8. ADA4896-2 Pin Function Descriptions

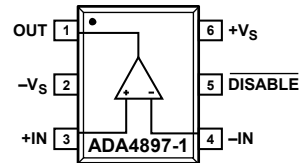
Pin No.	Mnemonic	Description
1	OUT1	Output 1.
2	-IN1	Inverting Input 1.
3	+IN1	Noninverting Input 1.
4	-Vs	Negative Supply.
5	+IN2	Noninverting Input 2.
6	-IN2	Inverting Input 2.
7	OUT2	Output 2.
8	+Vs EPAD	Positive Supply. Exposed Pad (LFCSP Only). The exposed pad can be connected to GND or power planes, or it can be left floating.



NC = NO CONNECT. DO NOT CONNECT TO THIS PIN.

09447-016

Figure 6. 8-Lead SOIC Pin Configuration



09447-017

Figure 7. 6-Lead SOT-23 Pin Configuration

Table 9. ADA4897-1 Pin Function Descriptions

Pin No.		Mnemonic	Description
SOIC	SOT-23		
1, 5	N/A	NC	No Connect. Do not connect to these pins.
2	4	-IN	Inverting Input.
3	3	+IN	Noninverting Input.
4	2	-Vs	Negative Supply.
6	1	OUT	Output.
7	6	+Vs	Positive Supply.
8	5	DISABLE	Disable.

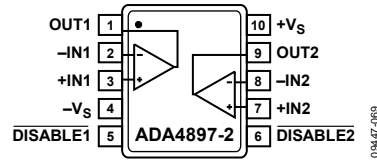


Figure 8. 10-Lead MSOP Pin Configuration

Table 10. ADA4897-2 Pin Function Descriptions

Pin No.	Mnemonic	Description
1	OUT1	Output 1.
2	-IN1	Inverting Input 1.
3	+IN1	Noninverting Input 1.
4	-Vs	Negative Supply.
5	$\overline{\text{DISABLE1}}$	Disable 1.
6	$\overline{\text{DISABLE2}}$	Disable 2.
7	+IN2	Noninverting Input 2.
8	-IN2	Inverting Input 2.
9	OUT2	Output 2.
10	+Vs	Positive Supply.

TYPICAL PERFORMANCE CHARACTERISTICS

$R_L = 1\text{ k}\Omega$, unless otherwise noted. When $G = +1$, $R_F = 0\ \Omega$; otherwise, $R_F = 249\ \Omega$.



Figure 9. Small Signal Frequency Response vs. Gain



Figure 12. Frequency Response for Various Output Voltages



Figure 10. Small Signal Frequency Response vs. Supply Voltage



Figure 13. 0.1 dB Bandwidth at Selected R_F Values



Figure 11. Small Signal Frequency Response vs. Temperature



Figure 14. Large Signal Frequency Response vs. Gain



Figure 15. Small Signal Frequency Response vs. Capacitive Load



Figure 18. Harmonic Distortion vs. Frequency, $G = +10$



Figure 16. Harmonic Distortion vs. Frequency, $G = +1$

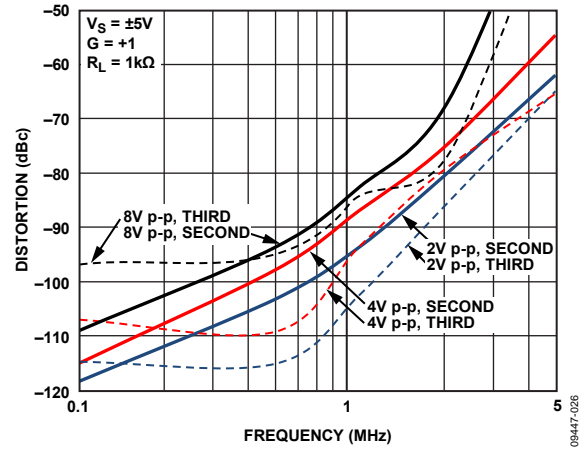


Figure 19. Harmonic Distortion vs. Frequency for Various Output Voltages



Figure 17. Harmonic Distortion vs. Frequency, $G = +5$



Figure 20. Harmonic Distortion vs. Frequency for Various Supplies

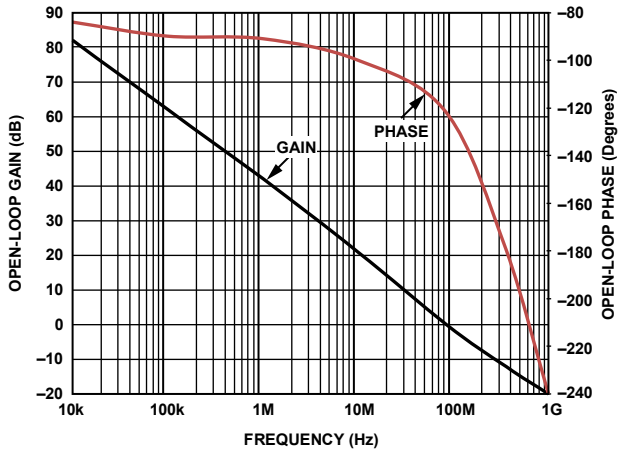


Figure 21. Open-Loop Gain and Phase vs. Frequency



Figure 24. Input Offset Voltage Drift Distribution

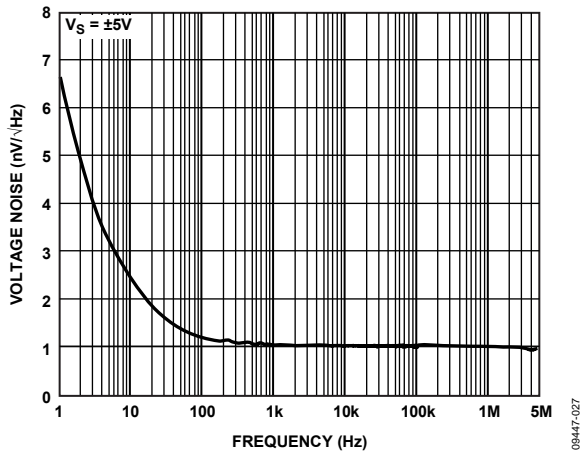


Figure 22. Voltage Noise vs. Frequency



Figure 25. Small Signal Transient Response for Various Supplies, G = +1

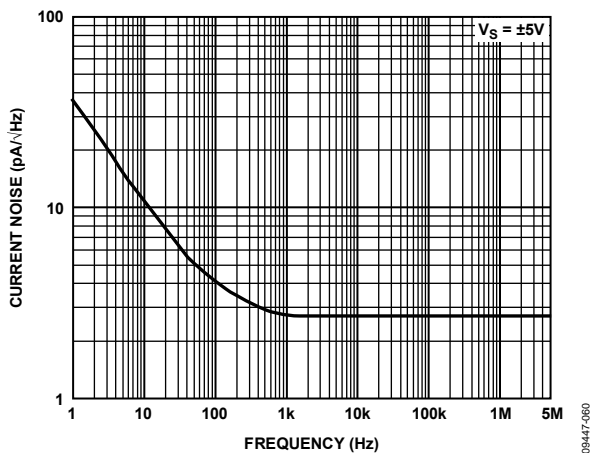


Figure 23. Current Noise vs. Frequency

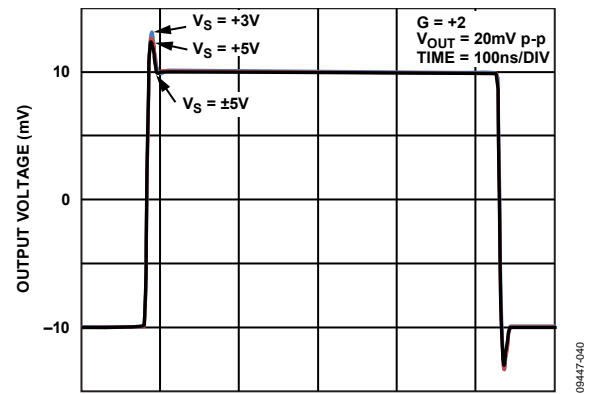


Figure 26. Small Signal Transient Response for Various Supplies, G = +2



Figure 27. Small Signal Transient Response for Various Capacitive Loads



Figure 30. Output Overdrive Recovery Time



Figure 28. Large Signal Transient Response, $G = +1$ and $G = +2$



Figure 31. Average Output Overload Recovery Time vs. Overload Duration



Figure 29. Input Overdrive Recovery Time

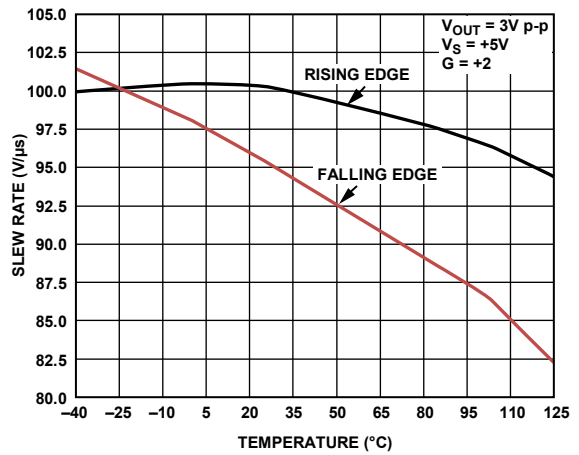


Figure 32. Slew Rate vs. Temperature



Figure 33. Settling Time to 0.1%



Figure 36. Output Impedance vs. Frequency

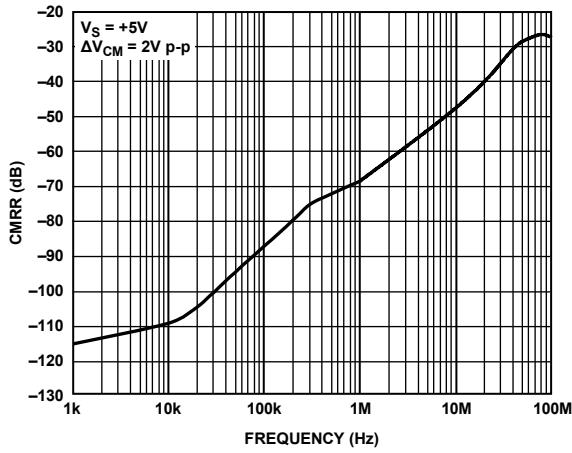


Figure 34. CMRR vs. Frequency

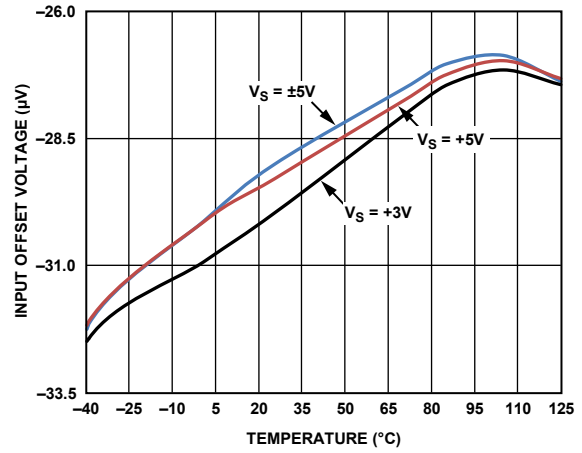


Figure 37. Input Offset Voltage vs. Temperature for Various Supplies

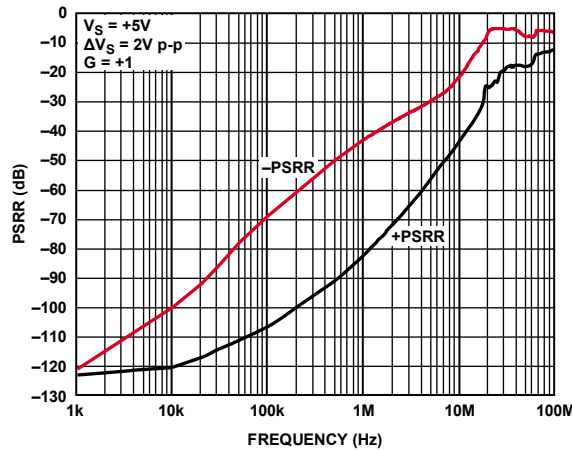


Figure 35. PSRR vs. Frequency

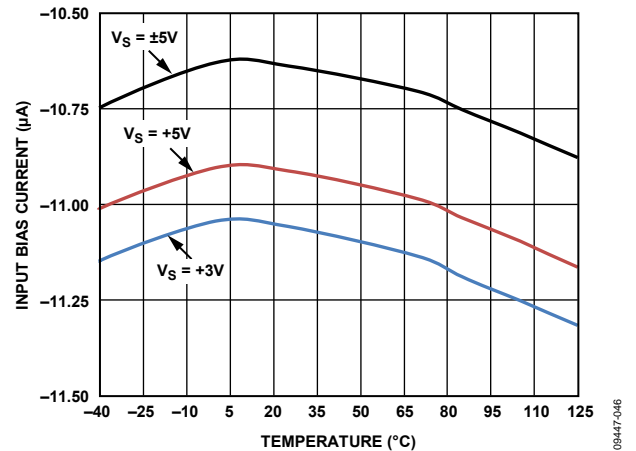


Figure 38. Input Bias Current vs. Temperature for Various Supplies



Figure 39. Supply Current vs. Temperature for Various Supplies



Figure 42. Turn-Off Time vs. Temperature (ADA4897-1 and ADA4897-2)



Figure 40. Crosstalk, OUT1 to OUT2 (ADA4896-2 and ADA4897-2)



Figure 43. Forward Isolation vs. Frequency

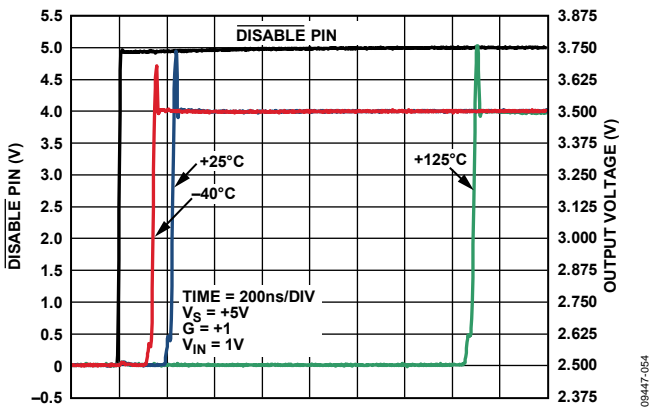


Figure 41. Turn-On Time vs. Temperature (ADA4897-1 and ADA4897-2)

DC ERRORS

Figure 46 shows a typical connection diagram and the major dc error sources.



Figure 46. Typical Connection Diagram and DC Error Sources

The ideal transfer function (all error sources set to 0 and infinite dc gain) can be written as

$$V_{OUT} = \left(1 + \frac{R_F}{R_G}\right) \times V_{IP} - \left(\frac{R_F}{R_G}\right) \times V_{IN} \quad (1)$$

This equation reduces to the familiar forms for noninverting and inverting op amp gain expressions, as follows:

For noninverting gain ($V_{IN} = 0$ V)

$$V_{OUT} = \left(1 + \frac{R_F}{R_G}\right) \times V_{IP} \quad (2)$$

For inverting gain ($V_{IP} = 0$ V)

$$V_{OUT} = \left(\frac{-R_F}{R_G}\right) \times V_{IN} \quad (3)$$

The total output voltage error is the sum of errors due to the amplifier offset voltage and input currents. The output error due to the offset voltage can be estimated as

$$V_{OUT_ERROR} = \left(V_{OFFSET_NOM} + \frac{V_{CM}}{CMRR} + \frac{V_P - V_{PNOM}}{PSRR} + \frac{V_{OUT}}{A} \right) \times \left(1 + \frac{R_F}{R_G}\right) \quad (4)$$

where:

V_{OFFSET_NOM} is the offset voltage at the specified supply voltage,

which is measured with the input and output at midsupply.

V_{CM} is the common-mode voltage.

V_P is the power supply voltage.

V_{PNOM} is the specified power supply voltage.

$CMRR$ is the common-mode rejection ratio.

$PSRR$ is the power supply rejection ratio.

A is the dc open-loop gain.

The output error due to the input currents can be estimated as

$$V_{OUT_ERROR} = (R_F \parallel R_G) \times \left(1 + \frac{R_F}{R_G}\right) \times I_{B-} - R_S \times \left(1 + \frac{R_F}{R_G}\right) \times I_{B+} \quad (5)$$

BIAS CURRENT CANCELLATION

To cancel the output voltage error due to unmatched bias currents at the inputs, R_{BP} and R_{BN} can be used (see Figure 47).



Figure 47. Using R_{BP} and R_{BN} to Cancel Bias Current Error

To compensate for the unmatched bias currents at the two inputs, set R_{BP} and R_{BN} as shown in Table 11.

Table 11. Setting R_{BN} and R_{BP} to Cancel Bias Current Errors

Value of $R_F \parallel R_G$	Value of R_{BP} (Ω)	Value of R_{BN} (Ω)
Greater Than R_S	$R_F \parallel R_G - R_S$	0
Less Than R_S	0	$R_S - R_F \parallel R_G$

Table 12 shows sample values for R_{BP} and R_{BN} when $R_F \parallel R_G > R_S$ and when $R_F \parallel R_G < R_S$.

Table 12. Examples of R_{BN} and R_{BP} Settings

Gain	R_F (Ω)	R_G (Ω)	R_S (Ω)	R_{BP} (Ω)	R_{BN} (Ω)
+2	249	249	50	74.5	0
+10	249	27.4	50	0	25.3

NOISE CONSIDERATIONS

Figure 48 illustrates the primary noise contributors for the typical gain configurations. The total rms output noise is the root-mean-square of all the contributions.



Figure 48. Noise Sources in Typical Connection

The output noise spectral density can be calculated by

$$v_{out_en} = \sqrt{4kTR_F + \left(1 + \frac{R_F}{R_G}\right)^2 \left[4kTR_S + i_{ep}^2 R_S^2 + \overline{v_{en}}^2\right] + \left(\frac{R_F}{R_G}\right)^2 4kTR_G + \overline{i_{en}}^2 R_F^2} \tag{6}$$

where:

k is Boltzmann’s constant.

T is the absolute temperature (degrees Kelvin).

i_{ep} and i_{en} represent the amplifier input current noise spectral density (pA/√Hz).

v_{en} is the amplifier input voltage noise spectral density (nV/√Hz).

R_S is the source resistance, as shown in Figure 48.

R_F and R_G are the feedback network resistances, as shown in Figure 48.

Source resistance noise, amplifier voltage noise ($\overline{v_{en}}$), and the voltage noise from the amplifier current noise ($i_{ep} \times R_S$) are all subject to the noise gain term $(1 + R_F/R_G)$. Note that with a 1 nV/√Hz input voltage noise and 2.8 pA/√Hz input current noise, the noise contributions of the amplifier are relatively small for source resistances from approximately 50 Ω to 700 Ω.

Figure 49 shows the total RTI noise due to the amplifier vs. the source resistance. In addition, the value of the feedback resistors used affects the noise. It is recommended that the value of the feedback resistors be maintained between 250 Ω and 1 kΩ to keep the total noise low.



Figure 49. RTI Noise vs. Source Resistance

CAPACITANCE DRIVE

Capacitance at the output of an amplifier creates a delay within the feedback path that, if within the bandwidth of the loop, can create excessive ringing and oscillation. The ADA4896-2/ADA4897-1/ADA4897-2 show the most peaking at a gain of +2 (see Figure 9).

Placing a small snub resistor (R_{SNUB}) in series with the amplifier output and the capacitive load mitigates the problem. Figure 50 shows the effect of using a snub resistor (R_{SNUB}) on reducing the peaking for the worst-case frequency response (gain of +2). Using $R_{SNUB} = 100 \Omega$ eliminates the peaking entirely, with the trade-off that the closed-loop gain is reduced by 0.8 dB due to attenuation at the output. R_{SNUB} can be adjusted from 0 Ω to 100 Ω to maintain an acceptable level of peaking and closed-loop gain (see Figure 50).

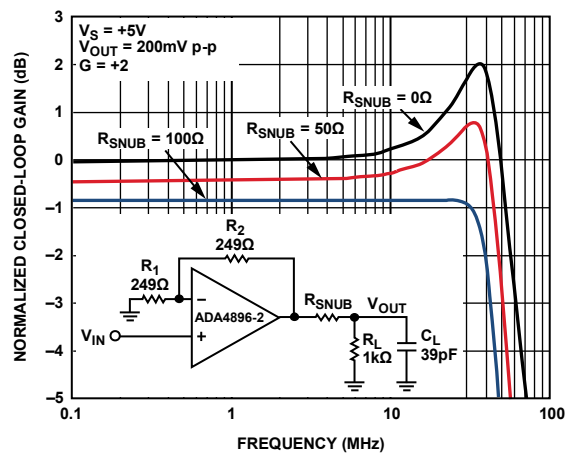


Figure 50. Using a Snub Resistor to Reduce Peaking Due to Output Capacitive Load

APPLICATIONS INFORMATION

TYPICAL PERFORMANCE VALUES

To reduce design time and eliminate uncertainty, Table 13 provides a reference for typical gains, component values, and performance parameters. The supply voltage used is 5 V. The bandwidth is obtained with a small signal output of 200 mV p-p, and the slew rate is obtained with a 2 V output step.

Note that as the gain increases, the small signal bandwidth decreases, as is expected from the gain bandwidth product relationship. In addition, the phase margin improves with higher gains, and the amplifier becomes more stable. As a result, the peaking in the frequency response is reduced (see Figure 51).



Figure 51. Small Signal Frequency Response at Various Gains

Table 13. Recommended Values and Typical Performance

Gain	R_F (Ω)	R_G (Ω)	-3 dB BW (MHz)	Slew Rate, t_R/t_F (V/ μ s)	Peaking (dB)	Total Output Noise Including Resistors (nV/ \sqrt{Hz})
+1	0	N/A	92	78/158	0.8	1.0
+2	249	249	54	101/140	1.2	3.6
+5	249	61.9	30	119/137	0	6.8
+10	249	27.4	17	87/88	0	12.0
+20	249	13.0	9	37/37	0	21.1

LOW NOISE, GAIN SELECTABLE AMPLIFIER



Figure 52. Using the ADA4896-2 and the ADG633 to Construct a Low Noise, Gain Selectable Amplifier to Drive a Low Resistive Load

A gain selectable amplifier makes processing a wide range of input signals possible. A traditional gain selectable amplifier uses switches in the feedback loops connecting to the inverting input. The switch resistances degrade the noise performance of the amplifier, as well as adding significant capacitance on the inverting input node. The noise and capacitance issues can be especially bothersome when working with low noise amplifiers. Also, the switch resistances contribute to nonlinear gain error, which is undesirable.

Figure 52 presents an innovative switching technique used in the gain selectable amplifier such that the 1 nV/Hz noise performance of the ADA4896-2 is preserved while the nonlinear gain error is much reduced. With this technique, the user can also choose switches with minimal capacitance to optimize the bandwidth of the circuit.

In the circuit shown in Figure 52, the switches are implemented with the ADG633 and are configured such that either S1A and S2A are on, or S1B and S2B are on. In this example, when the S1A and S2A switches are on, the first stage amplifier gain is +4. When the S1B and S2B switches are on, the first stage amplifier gain is +2. The first set of switches of the ADG633 is placed on the output side of the feedback loop, and the second set of switches is used to sample at a point (V1 or V2) where switch resistances and nonlinear resistances do not matter. In this way, the gain error can be reduced while preserving the noise performance of the ADA4896-2.

Note that the input bias current of the output buffer can cause problems with the impedance of the S2A and S2B sampling switches. Both sampling switches are not only nonlinear with voltage but with temperature as well. If this is an issue, place the unused switch of the ADG633 (S3B) in the feedback path of the output buffer to balance the bias currents (see Figure 52).

In addition, the bias current of the input amplifier causes an offset at the output that varies based on the gain setting. Because the input amplifier and the output buffer are monolithic, the relative matching of their bias currents can be used

to cancel out the varying offset. Placing a resistor equal to the difference between R_{F2} and R_{F1} in series with Switch S2A results in a more constant offset voltage.

The following derivation shows that sampling at V1 yields the desired signal gain without gain error. R_S denotes the switch resistance. V2 can be derived using the same method.

$$V_{01} = V_{IN} \times \left(1 + \frac{R_{F1} + R_{S1}}{R_{G1}} \right) \tag{7}$$

$$V1 = V_{01} \times \left(\frac{R_{F1} + R_{G1}}{R_{F1} + R_{G1} + R_{S1}} \right) \tag{8}$$

Substituting Equation 1 into Equation 2, the following derivation is obtained.

$$V1 = V_{IN} \times \left(1 + \frac{R_{F1}}{R_{G1}} \right) \tag{9}$$

Note that if V_{01} yields the desired signal gain without gain error, the buffered output V_{02} will also be free from gain error. Figure 53 shows the normalized frequency response of the circuit at V_{02} .



Figure 53. Frequency Response of V_{02}/V_{IN}

MEDICAL ULTRASOUND APPLICATIONS



Figure 54. Simplified Ultrasound System Block Diagram

09447-033

Overview of the Ultrasound System

Medical ultrasound systems are among the most sophisticated signal processing systems in widespread use today. By transmitting acoustic energy into the body and receiving and processing the returning reflections, ultrasound systems can generate images of internal organs and structures, map blood flow and tissue motion, and provide highly accurate blood velocity information. Figure 54 shows a simplified block diagram of an ultrasound system.

The ultrasound system consists of two main operations: the time gain control (TGC) operation and the continuous wave (CW) Doppler operation. The **AD9279** integrates the essential components of these two operations into a single IC. It contains eight channels of a variable gain amplifier (VGA) with a low noise preamplifier (LNA), an antialiasing filter (AAF), an analog-to-digital converter (ADC), and an I/Q demodulator with programmable phase rotation. For detailed information about how to use the **AD9279** in an ultrasound system, see the **AD9279** data sheet.

ADA4896-2/ADA4897-1/ADA4897-2 in the Ultrasound System

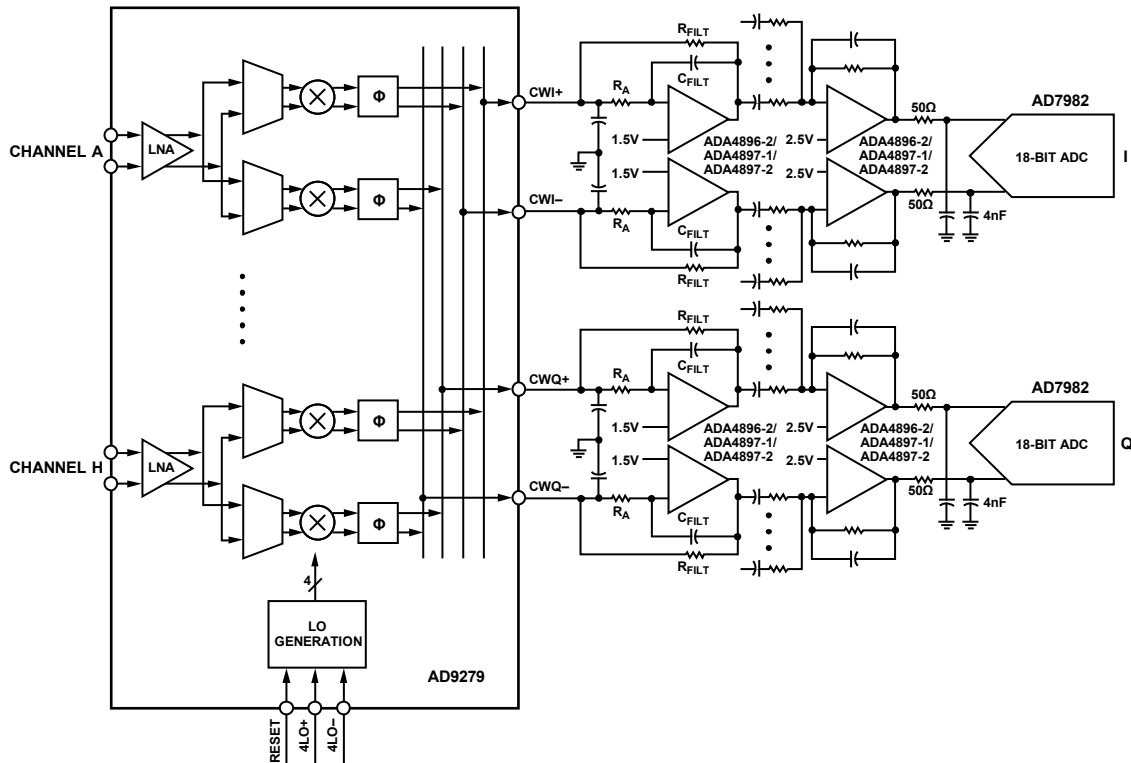


Figure 55. Using the ADA4896-2/ADA4897-1/ADA4897-2 as Filters, I-to-V Converters, Current Summers, and ADC Drivers After the I/Q Outputs of the AD9279

09447-032

The ADA4896-2/ADA4897-1/ADA4897-2 are used in the CW Doppler path in the ultrasound application after the I/Q demodulators of the AD9279. Doppler signals can be typically between 100 Hz to 100 kHz. The low noise floor and high dynamic range of the ADA4896-2/ADA4897-1/ADA4897-2 make them excellent choices for processing weak Doppler signals.

The rail-to-rail output and the high output current drive of the ADA4896-2/ADA4897-1/ADA4897-2 make them suitable candidates for the I-to-V converter, current summer, and ADC driver.

Figure 55 shows an interconnection block diagram of all eight channels of the AD9279. Two stages of the ADA4896-2 amplifiers are used. The first stage performs an I-to-V conversion and filters the high frequency content that results from the demodulation process. The second stage of the ADA4896-2 amplifiers is used to sum the output currents of multiple AD9279 devices, to provide gain, and to drive the AD7982 device, an 18-bit SAR ADC.

The output-referred noise of the CW signal path depends on the LNA gain, the selection of the first stage summing amplifier, and the value of R_{FILT} . To determine the output-referred noise, it is important to know the active low-pass filter (LPF) values R_A , R_{FILT} , and C_{FILT} , as shown as Figure 55. Typical filter values for all eight channels of a single AD9279 are 100 Ω for R_A , 500 Ω for R_{FILT} , and 2.0 nF for C_{FILT} ; these values implement a 100 kHz, single-pole LPF.

The gain of the I-to-V converter can be increased by increasing the filter resistor, R_{FILT} . To keep the corner frequency unchanged, decrease the filter capacitor, C_{FILT} , by the same factor. The factor limiting the magnitude of the gain is the output swing and drive capability of the op amp selected for the I-to-V converter, in this example, the ADA4896-2/ADA4897-1/ADA4897-2. Because any amplifier has limited drive capability, a finite number of channels can be summed.

LAYOUT CONSIDERATIONS

To ensure optimal performance, careful and deliberate attention must be paid to the board layout, signal routing, power supply bypassing, and grounding.

Ground Plane

It is important to avoid ground in the areas under and around the input and output of the [ADA4896-2/ADA4897-1/ADA4897-2](#). Stray capacitance created between the ground plane and the input and output pads of a device is detrimental to high speed amplifier performance. Stray capacitance at the inverting input, along with the amplifier input capacitance, lowers the phase margin and can cause instability. Stray capacitance at the output creates a pole in the feedback loop, which can reduce phase margin and can cause the circuit to become unstable.

Power Supply Bypassing

Power supply bypassing is a critical aspect in the performance of the [ADA4896-2/ADA4897-1/ADA4897-2](#). A parallel connection of capacitors from each power supply pin to ground works best. Smaller value capacitor electrolytics offer better high frequency response, whereas larger value capacitor electrolytics offer better low frequency performance.

Paralleling different values and sizes of capacitors helps to ensure that the power supply pins are provided with a low ac impedance across a wide band of frequencies. This is important for minimizing the coupling of noise into the amplifier—especially when the amplifier PSRR begins to roll off—because the bypass capacitors can help lessen the degradation in PSRR performance.

The smallest value capacitor should be placed on the same side of the board as the amplifier and as close as possible to the amplifier power supply pins. The ground end of the capacitor should be connected directly to the ground plane.

It is recommended that a 0.1 μF ceramic capacitor with a 0508 case size be used. The 0508 case size offers low series inductance and excellent high frequency performance. A 10 μF electrolytic capacitor should be placed in parallel with the 0.1 μF capacitor. Depending on the circuit parameters, some enhancement to performance can be realized by adding additional capacitors. Each circuit is different and should be analyzed individually for optimal performance.

OUTLINE DIMENSIONS



COMPLIANT TO JEDEC STANDARDS MO-187-AA

Figure 56. 8-Lead Mini Small Outline Package [MSOP] (RM-8)

Dimensions shown in millimeters

10-07-2009-B



COMPLIANT TO JEDEC STANDARDS MO-229-WEED

Figure 57. 8-Lead Lead Frame Chip Scale Package [LFCS_P_WD] 3 mm x 3 mm Body, Very Very Thin, Dual Lead (CP-8-11)

Dimensions shown in millimeters

01-24-2011-B



COMPLIANT TO JEDEC STANDARDS MS-012-AA
 CONTROLLING DIMENSIONS ARE IN MILLIMETERS; INCH DIMENSIONS
 (IN PARENTHESES) ARE ROUNDED-OFF MILLIMETER EQUIVALENTS FOR
 REFERENCE ONLY AND ARE NOT APPROPRIATE FOR USE IN DESIGN.

Figure 58. 8-Lead Standard Small Outline Package [SOIC_N]
 Narrow Body
 (R-8)

Dimensions shown in millimeters and (inches)

012407-A



COMPLIANT TO JEDEC STANDARDS MO-178-AB

Figure 59. 6-Lead Small Outline Transistor Package [SOT-23]
 (RJ-6)

Dimensions shown in millimeters

12-16-2008-A



COMPLIANT TO JEDEC STANDARDS MO-187-BA

Figure 60. 10-Lead Mini Small Outline Package [MSOP] (RM-10)

Dimensions shown in millimeters

091708-A

ORDERING GUIDE

Model ¹	Temperature Range	Package Description	Package Option	Ordering Quantity	Branding
ADA4896-2ARMZ	-40°C to +125°C	8-Lead MSOP	RM-8	50	H2P
ADA4896-2ARMZ-R7	-40°C to +125°C	8-Lead MSOP	RM-8	1,000	H2P
ADA4896-2ARMZ-RL	-40°C to +125°C	8-Lead MSOP	RM-8	3,000	H2P
ADA4896-2ACPZ-R2	-40°C to +125°C	8-Lead LFCSP_WD	CP-8-11	250	H2P
ADA4896-2ACPZ-R7	-40°C to +125°C	8-Lead LFCSP_WD	CP-8-11	1,500	H2P
ADA4896-2ACPZ-RL	-40°C to +125°C	8-Lead LFCSP_WD	CP-8-11	5,000	H2P
ADA4896-2ACP-EBZ		Evaluation Board for the 8-Lead LFCSP			
ADA4896-2ARM-EBZ		Evaluation Board for the 8-Lead MSOP			
ADA4897-1ARZ	-40°C to +125°C	8-Lead SOIC_N	R-8	98	
ADA4897-1ARZ-R7	-40°C to +125°C	8-Lead SOIC_N	R-8	1,000	
ADA4897-1ARZ-RL	-40°C to +125°C	8-Lead SOIC_N	R-8	2,500	
ADA4897-1ARJZ-R2	-40°C to +125°C	6-Lead SOT-23	RJ-6	250	H2K
ADA4897-1ARJZ-R7	-40°C to +125°C	6-Lead SOT-23	RJ-6	3,000	H2K
ADA4897-1ARJZ-RL	-40°C to +125°C	6-Lead SOT-23	RJ-6	10,000	H2K
ADA4897-1AR-EBZ		Evaluation Board for the 8-Lead SOIC_N			
ADA4897-1ARJ-EBZ		Evaluation Board for the 6-Lead SOT-23			
ADA4897-2ARMZ	-40°C to +125°C	10-Lead MSOP	RM-10	50	H2N
ADA4897-2ARMZ-R7	-40°C to +125°C	10-Lead MSOP	RM-10	1,000	H2N
ADA4897-2ARMZ-RL	-40°C to +125°C	10-Lead MSOP	RM-10	3,000	H2N
ADA4897-2ARM-EBZ		Evaluation Board for the 10-Lead MSOP			

¹ Z = RoHS Compliant Part.

NOTES

X-ON Electronics

Largest Supplier of Electrical and Electronic Components

Click to view similar products for [High Speed Operational Amplifiers](#) category:

Click to view products by [Analog Devices](#) manufacturer:

Other Similar products are found below :

[NJU7047RB1-TE2](#) [LTC6226IS8#PBF](#) [LTC6226HS8#PBF](#) [LT1058ACN](#) [LT1206CR](#) [LT1058ISW](#) [THS4222DGNR](#) [OPA2677IDDAR](#)
[THS6042ID](#) [THS4221DBVR](#) [THS4081CD](#) [ADA4858-3ACPZ-R7](#) [LT6202IS5#TRMPBF](#) [LT1206CR#PBF](#) [LTC6253CMS8#PBF](#)
[LT1813CDD#PBF](#) [ADA4851-4YRUZ-RL](#) [LT1037IN8#PBF](#) [LTC6401CUD-20#PBF](#) [LT1192CN8#PBF](#) [LTC6401IUD-26#PBF](#)
[LT1037ACN8#PBF](#) [LTC6253CTS8#TRMPBF](#) [LT1399HVCS#PBF](#) [LT1993CUD-2#PBF](#) [LT6203CDD#PBF](#) [LT1722CS8#PBF](#)
[LT1208CN8#PBF](#) [LT1222CN8#PBF](#) [LT6203IDD#PBF](#) [LT6411IUD#PBF](#) [LTC6400CUD-26#PBF](#) [LTC6400CUD-8#PBF](#) [LT6211IDD#PBF](#)
[OP27EN8#PBF](#) [LT1810IMS8#PBF](#) [OP37EN8#PBF](#) [LTC6253IMS8#PBF](#) [LT1360CS8](#) [OPA2132PAG4](#) [OPA2353UA/2K5](#) [OPA2691I-14D](#)
[OPA4353UA/2K5](#) [OPA690IDRG4](#) [LMH6723MFX/NOPB](#) [ADP5302ACPZ-3-R7](#) [AD8007AKSZ-REEL7](#) [AD8008ARMZ](#) [AD8009JRTZ-](#)
[REEL7](#) [AD8010ANZ](#)