

FEATURES

Extremely low harmonic distortion (HD)

- 106 dBc HD2 @ 10 MHz
- 82 dBc HD2 @ 50 MHz
- 109 dBc HD3 @ 10 MHz
- 82 dBc HD3 @ 50 MHz

Low input voltage noise: 2.6 nV/ $\sqrt{\text{Hz}}$

High speed

- 3 dB bandwidth of 1000 MHz, $G = +1$
- Slew rate: 4700 V/ μs
- 0.1 dB gain flatness to 150 MHz
- Fast overdrive recovery of 4 ns

1 mV typical offset voltage

Externally adjustable gain

Differential-to-differential or single-ended-to-differential operation

Adjustable output common-mode voltage

Wide supply voltage range: +5 V to ± 5 V

Single or dual amplifier configuration available

APPLICATIONS

ADC drivers

Single-ended-to-differential converters

IF and baseband gain blocks

Differential buffers

Line drivers

GENERAL DESCRIPTION

The ADA4938-1/ADA4938-2 are low noise, ultralow distortion, high speed differential amplifiers. It is an ideal choice for driving high performance ADCs with resolutions up to 16 bits from dc to 27 MHz, or up to 12 bits from dc to 74 MHz. The output common-mode voltage is adjustable over a wide range, allowing the ADA4938-1/ADA4938-2 to match the input of the ADC. The internal common-mode feedback loop also provides exceptional output balance as well as suppression of even-order harmonic distortion products.

Full differential and single-ended-to-differential gain configurations are easily realized with the ADA4938-1/ADA4938-2. A simple external feedback network of four resistors determines the closed-loop gain of the amplifier.

The ADA4938-1/ADA4938-2 are fabricated using the Analog Devices, Inc., proprietary third generation, high voltage XFCB process, enabling it to achieve very low levels of distortion with an input voltage noise of only 2.6 nV/ $\sqrt{\text{Hz}}$. The low dc offset and excellent dynamic performance of the ADA4938-1/ADA4938-2

FUNCTIONAL BLOCK DIAGRAMS

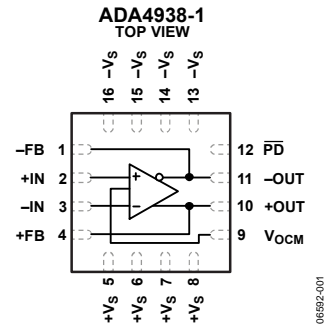

Figure 1. ADA4938-1 Functional Block Diagram

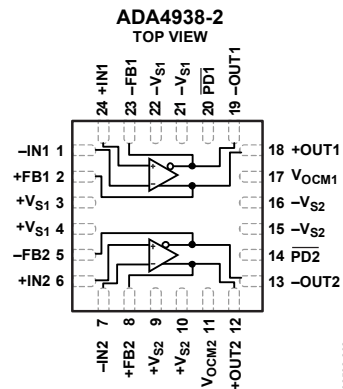

Figure 2. ADA4938-2 Functional Block Diagram

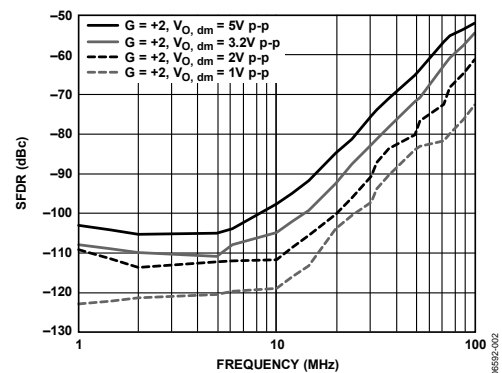

Figure 3. SFDR vs. Frequency and Output Voltage

makes them well-suited for a wide variety of data acquisition and signal processing applications.

The ADA4938-1 (single amplifier) is available in a Pb-free, 3 mm \times 3 mm, 16-lead LFCSP. The ADA4938-2 (dual amplifier) is available in a Pb-free, 4 mm \times 4 mm, 24-lead LFCSP. The pinouts have been optimized to facilitate layout and minimize distortion. The devices are specified to operate over the extended industrial temperature range of -40°C to $+85^{\circ}\text{C}$.

Rev. B

Document Feedback

Information furnished by Analog Devices is believed to be accurate and reliable. However, no responsibility is assumed by Analog Devices for its use, nor for any infringements of patents or other rights of third parties that may result from its use. Specifications subject to change without notice. No license is granted by implication or otherwise under any patent or patent rights of Analog Devices. Trademarks and registered trademarks are the property of their respective owners.

TABLE OF CONTENTS

Features 1
 Applications..... 1
 General Description 1
 Functional Block Diagrams..... 1
 Revision History 2
 Specifications..... 3
 Dual-Supply Operation 3
 Single-Supply Operation 5
 Absolute Maximum Ratings..... 7
 Thermal Resistance 7
 ESD Caution..... 7
 Pin Configurations and Function Descriptions 8
 Typical Performance Characteristics 9
 Test Circuits..... 17
 Terminology 18

Theory of Operation 19
 Analyzing an Application Circuit 19
 Setting the Closed-Loop Gain 19
 Estimating the Output Noise Voltage 19
 The Impact of Mismatches in the Feedback Networks 20
 Calculating the Input Impedance of an Application Circuit 20
 Input Common-Mode Voltage Range in Single-Supply Applications 20
 Terminating a Single-Ended Input 21
 Setting the Output Common-Mode Voltage 21
 Layout, Grounding, and Bypassing..... 23
 High Performance ADC Driving 24
 Outline Dimensions 25
 Ordering Guide 25

REVISION HISTORY

6/2016—Rev. A to Rev. B

Changed CP-16-2 to CP-16-21, CP-24-1 to CP-24-10.. Throughout
 Changed ADA4938-x to ADA4938-1/ADA4938-2.. Throughout
 Changes to Figure 1 and Figure 2 1
 Changes to Figure 5 and Figure 6 8
 Updated Outline Dimensions 25
 Changes to Ordering Guide 25

10/2009—Rev. 0 to Rev. A

Added Settling Time Parameter, Table 1 3
 Changes to Linear Output Current Parameter, Table 1 3

Added Settling Time Parameter, Table 35
 Changes to Linear Output Current Parameter, Table 3.....5
 Changes to Figure 5 and Figure 6.....8
 Added EP Row to Table 7 and EP Row to Table 88
 Changes to Figure 41..... 14
 Added New Figure 53, Renumbered Sequentially 16
 Changes to Table 9..... 19
 Added Exposed Pad Notation to Outline Dimensions 25
 Changes to Ordering Guide 25

11/2007—Revision 0: Initial Version

SPECIFICATIONS

DUAL-SUPPLY OPERATION

$T_A = 25^\circ\text{C}$, $+V_S = 5\text{ V}$, $-V_S = -5\text{ V}$, $V_{\text{OCM}} = 0\text{ V}$, $R_T = 61.9\ \Omega$, $R_G = R_F = 200\ \Omega$, $G = +1$, $R_{L, \text{dm}} = 1\text{ k}\Omega$, unless otherwise noted.

All specifications refer to single-ended input and differential output, unless otherwise noted. For gains other than $G = +1$, values for R_F and R_G are shown in Table 11.

$\pm D_{\text{IN}}$ to $\pm \text{OUT}$ Performance

Table 1.

| Parameter | Conditions | Min | Typ | Max | Unit |
|-----------------------------------|---|-----|------------------------------|-----|---|
| DYNAMIC PERFORMANCE | | | | | |
| -3 dB Small Signal Bandwidth | $V_{\text{OUT}} = 0.1\text{ V p-p}$ | | 1000 | | MHz |
| Bandwidth for 0.1 dB Flatness | $V_{\text{OUT}} = 2\text{ V p-p}$ | | 150 | | MHz |
| Large Signal Bandwidth | $V_{\text{OUT}} = 2\text{ V p-p}$ | | 800 | | MHz |
| Slew Rate | $V_{\text{OUT}} = 2\text{ V p-p}$ | | 4700 | | V/ μs |
| Settling Time | $V_{\text{OUT}} = 2\text{ V p-p}$ | | 6.5 | | ns |
| Overdrive Recovery Time | $V_{\text{IN}} = 5\text{ V to } 0\text{ V step}$, $G = +2$ | | 4 | | ns |
| NOISE/HARMONIC PERFORMANCE | | | | | |
| Second Harmonic | $V_{\text{OUT}} = 2\text{ V p-p}$, 10 MHz | | -106 | | dBc |
| | $V_{\text{OUT}} = 2\text{ V p-p}$, 50 MHz | | -82 | | dBc |
| Third Harmonic | $V_{\text{OUT}} = 2\text{ V p-p}$, 10 MHz | | -109 | | dBc |
| | $V_{\text{OUT}} = 2\text{ V p-p}$, 50 MHz | | -82 | | dBc |
| IMD | $f_1 = 30.0\text{ MHz}$, $f_2 = 30.1\text{ MHz}$ | | 89 | | dBc |
| IP3 | $f = 30\text{ MHz}$, $R_{L, \text{dm}} = 100\ \Omega$ | | 45 | | dBm |
| Input Voltage Noise | $f = 10\text{ MHz}$ | | 2.6 | | nV/ $\sqrt{\text{Hz}}$ |
| Noise Figure | $G = +4$, $f = 10\text{ MHz}$ | | 15.8 | | dB |
| Input Current Noise | $f = 10\text{ MHz}$ | | 4.8 | | pA/ $\sqrt{\text{Hz}}$ |
| Crosstalk (ADA4938-2) | $f = 100\text{ MHz}$ | | -85 | | dB |
| INPUT CHARACTERISTICS | | | | | |
| Offset Voltage | $V_{\text{OS, dm}} = V_{\text{OUT, dm}}/2$; $V_{\text{DIN+}} = V_{\text{DIN-}} = 0\text{ V}$ T_{MIN} to T_{MAX} variation | | 1 ± 4 | 4 | mV $\mu\text{V}/^\circ\text{C}$ |
| Input Bias Current | T_{MIN} to T_{MAX} variation | -18 | -13 -0.01 | | μA $\mu\text{A}/^\circ\text{C}$ |
| Input Resistance | Differential | | 6 | | M Ω |
| | Common mode | | 3 | | M Ω |
| Input Capacitance | | | 1 | | pF |
| Input Common-Mode Voltage | | | $-V_S + 0.3$ to $+V_S - 1.6$ | | V |
| CMRR | $\Delta V_{\text{OUT, dm}}/\Delta V_{\text{IN, cm}}$; $\Delta V_{\text{IN, cm}} = \pm 1\text{ V}$, $f = 1\text{ MHz}$ | | -75 | | dB |
| OUTPUT CHARACTERISTICS | | | | | |
| Output Voltage Swing | Maximum ΔV_{OUT} ; single-ended output | | $-V_S + 1.2$ to $+V_S - 1.2$ | | V |
| Linear Output Current | Per amplifier, $R_{L, \text{dm}} = 20\ \Omega$, $f = 10\text{ MHz}$ | | ± 75 | | mA |
| Output Balance Error | $\Delta V_{\text{OUT, cm}}/\Delta V_{\text{OUT, dm}}$; $\Delta V_{\text{OUT, dm}} = 1\text{ V}$; $f = 10\text{ MHz}$ | | -60 | | dB |

V_{OCM} to $\pm OUT$ Performance

Table 2.

| Parameter | Conditions | Min | Typ | Max | Unit | |
|---------------------------------|--|---|------------------------------|----------|------------------------------|-----|
| V_{OCM} DYNAMIC PERFORMANCE | | | | | | |
| –3 dB Bandwidth | $V_{IN} = -3.4\text{ V to } +3.4\text{ V, } 25\% \text{ to } 75\%$ | | 230 | | MHz | |
| Slew Rate | | | 1700 | | V/ μs | |
| Input Voltage Noise (RTI) | | | 7.5 | | nV/ $\sqrt{\text{Hz}}$ | |
| V_{OCM} INPUT CHARACTERISTICS | | | | | | |
| Input Voltage Range | $V_{OS,cm} = V_{OUT,cm}; V_{DIN+} = V_{DIN-} = 0\text{ V}$ | | $-V_S + 1.3$ to $+V_S - 1.3$ | | V | |
| Input Resistance | | | 10 | | k Ω | |
| Input Offset Voltage | | | 3 | | mV | |
| Input Bias Current | | | 0.5 | | μA | |
| V_{OCM} CMRR | | $\Delta V_{OUT,dm}/\Delta V_{OCM}; \Delta V_{OCM} = \pm 1\text{ V}$ | | –81 | | dB |
| Gain | | $\Delta V_{OUT,cm}/\Delta V_{OCM}; \Delta V_{OCM} = \pm 1\text{ V}$ | 0.95 | 1.00 | 1.05 | V/V |
| POWER SUPPLY | | | | | | |
| Operating Range | Per amplifier T_{MIN} to T_{MAX} variation Powered down | 4.5 | | 11 | V | |
| Quiescent Current | | | 37 | 40 | mA | |
| | | | 40 | | $\mu\text{A}/^\circ\text{C}$ | |
| | | | 2.0 | 3.0 | mA | |
| Power Supply Rejection Ratio | $\Delta V_{OUT,dm}/\Delta V_S; \Delta V_S = \pm 1\text{ V}$ | | –80 | | dB | |
| POWER DOWN (\overline{PD}) | | | | | | |
| \overline{PD} Input Voltage | Powered down Enabled | | ≤ 2.5 | | V | |
| | | | | ≥ 3 | | V |
| Turn-Off Time | | | 1 | | μs | |
| Turn-On Time | | | 200 | | ns | |
| \overline{PD} Bias Current | | | | | | |
| Enabled | $\overline{PD} = 5\text{ V}$ | | 1 | | μA | |
| Disabled | $\overline{PD} = -5\text{ V}$ | | –760 | | μA | |
| OPERATING TEMPERATURE RANGE | | –40 | | +85 | $^\circ\text{C}$ | |

SINGLE-SUPPLY OPERATION

$T_A = 25^\circ\text{C}$, $+V_S = 5\text{ V}$, $-V_S = 0\text{ V}$, $V_{OCM} = +V_S/2$, $R_T = 61.9\ \Omega$, $R_G = R_F = 200\ \Omega$, $G = +1$, $R_{L, dm} = 1\text{ k}\Omega$, unless otherwise noted.

All specifications refer to single-ended input and differential output, unless otherwise noted. For gains other than $G = 1$, values for R_F and R_G are shown in Table 11.

 $\pm D_{IN}$ to $\pm OUT$ Performance**Table 3.**

| Parameter | Conditions | Min | Typ | Max | Unit |
|-----------------------------------|--|-----|------------------------------|-----|---|
| DYNAMIC PERFORMANCE | | | | | |
| -3 dB Small Signal Bandwidth | $V_{OUT} = 0.1\text{ V p-p}$ | | 1000 | | MHz |
| Bandwidth for 0.1 dB Flatness | $V_{OUT} = 2\text{ V p-p}$ | | 150 | | MHz |
| Large Signal Bandwidth | $V_{OUT} = 2\text{ V p-p}$ | | 750 | | MHz |
| Slew Rate | $V_{OUT} = 2\text{ V p-p}$ | | 3900 | | V/ μs |
| Settling Time | $V_{OUT} = 2\text{ V p-p}$ | | 6.5 | | ns |
| Overdrive Recovery Time | $V_{IN} = 2.5\text{ V to } 0\text{ V step, } G = +2$ | | 4 | | ns |
| NOISE/HARMONIC PERFORMANCE | | | | | |
| Second Harmonic | $V_{OUT} = 2\text{ V p-p, } 10\text{ MHz}$ | | -110 | | dBc |
| | $V_{OUT} = 2\text{ V p-p, } 50\text{ MHz}$ | | -79 | | dBc |
| Third Harmonic | $V_{OUT} = 2\text{ V p-p, } 10\text{ MHz}$ | | -100 | | dBc |
| | $V_{OUT} = 2\text{ V p-p, } 50\text{ MHz}$ | | -79 | | dBc |
| Input Voltage Noise | $f = 10\text{ MHz}$ | | 2.6 | | nV/ $\sqrt{\text{Hz}}$ |
| Noise Figure | $G = +4, f = 10\text{ MHz}$ | | 15.8 | | dB |
| Input Current Noise | $f = 10\text{ MHz}$ | | 4.8 | | pA/ $\sqrt{\text{Hz}}$ |
| Crosstalk (ADA4938-2) | $f = 100\text{ MHz}$ | | -85 | | dB |
| INPUT CHARACTERISTICS | | | | | |
| Offset Voltage | $V_{OS, dm} = V_{OUT, dm}/2; V_{DIN+} = V_{DIN-} = V_{OCM} = 2.5\text{ V}$ T_{MIN} to T_{MAX} variation | | 1 ± 4 | 4 | mV $\mu\text{V}/^\circ\text{C}$ |
| Input Bias Current | T_{MIN} to T_{MAX} variation | -18 | -13 -0.01 | | μA $\mu\text{A}/^\circ\text{C}$ |
| Input Resistance | Differential | | 6 | | M Ω |
| | Common mode | | 3 | | M Ω |
| Input Capacitance | | | 1 | | pF |
| Input Common-Mode Voltage | | | $-V_S + 0.3$ to $+V_S - 1.6$ | | V |
| CMRR | $\Delta V_{OUT, dm}/\Delta V_{IN, cm}; \Delta V_{IN, cm} = \pm 1\text{ V}$ | | -80 | | dB |
| OUTPUT CHARACTERISTICS | | | | | |
| Output Voltage Swing | Maximum ΔV_{OUT} ; single-ended output | | $-V_S + 1.2$ to $+V_S - 1.2$ | | V |
| Linear Output Current | Per amplifier, $R_{L, dm} = 20\ \Omega, f = 10\text{ MHz}$ | | ± 65 | | mA |
| Output Balance Error | $\Delta V_{OUT, cm}/\Delta V_{OUT, dm}; \Delta V_{OUT, dm} = 1\text{ V}$ | | -60 | | dB |

V_{OCM} to $\pm OUT$ Performance

Table 4.

| Parameter | Conditions | Min | Typ | Max | Unit |
|---------------------------------|--|------|-------------------------------------|------|------------------------|
| V_{OCM} DYNAMIC PERFORMANCE | | | | | |
| –3 dB Bandwidth | | | 400 | | MHz |
| Slew Rate | $V_{IN} = 1.6\text{ V to }3.4\text{ V, }25\% \text{ to }75\%$ | | 1700 | | V/ μ s |
| Input Voltage Noise (RTI) | | | 7.5 | | nV/ $\sqrt{\text{Hz}}$ |
| V_{OCM} INPUT CHARACTERISTICS | | | | | |
| Input Voltage Range | | | $-V_S + 1.3 \text{ to } +V_S - 1.3$ | | V |
| Input Resistance | | | 10 | | k Ω |
| Input Offset Voltage | $V_{OS,cm} = V_{OUT,cm}; V_{DIN+} = V_{DIN-} = V_{OCM} = 2.5\text{ V}$ | | 3 | | mV |
| Input Bias Current | | | 0.5 | | μ A |
| V_{OCM} CMRR | $\Delta V_{OUT,dm}/\Delta V_{OCM}; \Delta V_{OCM} = \pm 1\text{ V}$ | | –89 | | dB |
| Gain | $\Delta V_{OUT,cm}/\Delta V_{OCM}; \Delta V_{OCM} = \pm 1\text{ V}$ | 0.95 | 1.00 | 1.05 | V/V |
| POWER SUPPLY | | | | | |
| Operating Range | | 4.5 | | 11 | V |
| Quiescent Current | | | 34 | 36.5 | mA |
| | T_{MIN} to T_{MAX} variation | | 40 | | μ A/ $^{\circ}$ C |
| | Powered down | | 1.0 | 1.7 | mA |
| Power Supply Rejection Ratio | $\Delta V_{OUT,dm}/\Delta V_S; \Delta V_S = \pm 1\text{ V}$ | | –80 | | dB |
| POWER DOWN (\overline{PD}) | | | | | |
| \overline{PD} Input Voltage | Powered down | | ≤ 2.5 | | V |
| | Enabled | | ≥ 3 | | V |
| Turn-Off Time | | | 1 | | μ s |
| Turn-On Time | | | 200 | | ns |
| PD Bias Current | | | | | |
| Enabled | $\overline{PD} = 5\text{ V}$ | | 1 | | μ A |
| Disabled | $\overline{PD} = 0\text{ V}$ | | –260 | | μ A |
| OPERATING TEMPERATURE RANGE | | –40 | | +85 | $^{\circ}$ C |

ABSOLUTE MAXIMUM RATINGS

Table 5.

| Parameter | Rating |
|--------------------------------------|-----------------|
| Supply Voltage | 12 V |
| Power Dissipation | See Figure 4 |
| Storage Temperature Range | -65°C to +125°C |
| Operating Temperature Range | -40°C to +85°C |
| Lead Temperature (Soldering, 10 sec) | 300°C |
| Junction Temperature | 150°C |

Stresses at or above those listed under Absolute Maximum Ratings may cause permanent damage to the product. This is a stress rating only; functional operation of the product at these or any other conditions above those indicated in the operational section of this specification is not implied. Operation beyond the maximum operating conditions for extended periods may affect product reliability.

THERMAL RESISTANCE

θ_{JA} is specified for the device (including exposed pad) soldered to a high thermal conductivity 4-layer circuit board, as described in EIA/JESD 51-7. The exposed pad is not electrically connected to the device. It is typically soldered to a pad on the PCB that is thermally and electrically connected to an internal ground plane.

Table 6. Thermal Resistance

| Package Type | θ_{JA} | Unit |
|-----------------------------|---------------|------|
| 16-Lead LFCSP (Exposed Pad) | 95 | °C/W |
| 24-Lead LFCSP (Exposed Pad) | 65 | °C/W |

Maximum Power Dissipation

The maximum safe power dissipation in the ADA4938-1/ADA4938-2 packages is limited by the associated rise in junction temperature (T_j) on the die. At approximately 150°C, which is the glass transition temperature, the plastic changes its properties. Even temporarily exceeding this temperature limit can change the stresses that the package exerts on the die, permanently shifting the parametric performance of the ADA4938-1/ADA4938-2. Exceeding a junction temperature of 150°C for an extended period can result in changes in the silicon devices, potentially causing failure.

The power dissipated in the package (P_D) is the sum of the quiescent power dissipation and the power dissipated in the package due to the load drive. The quiescent power is the voltage between the supply pins (V_S) times the quiescent current (I_S). The power dissipated due to the load drive depends upon the particular application. The power due to load drive is calculated by multiplying the load current by the associated voltage drop across the device. RMS voltages and currents must be used in these calculations.

Airflow increases heat dissipation, which effectively reduces θ_{JA} . In addition, more metal directly in contact with the package leads/exposed pad from metal traces, through-holes, ground, and power planes reduces the θ_{JA} .

Figure 4 shows the maximum safe power dissipation in the package vs. the ambient temperature for the ADA4938-1, 16-lead LFCSP (95°C/W) and the ADA4938-2, 24-lead LFCSP (65°C/W) on a JEDEC standard 4-layer board.

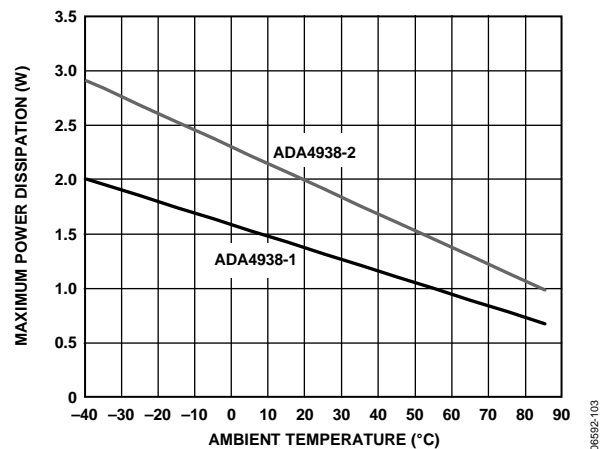

Figure 4. Maximum Power Dissipation vs. Temperature, 4-Layer Board

ESD CAUTION



ESD (electrostatic discharge) sensitive device. Charged devices and circuit boards can discharge without detection. Although this product features patented or proprietary protection circuitry, damage may occur on devices subjected to high energy ESD. Therefore, proper ESD precautions should be taken to avoid performance degradation or loss of functionality.

PIN CONFIGURATIONS AND FUNCTION DESCRIPTIONS

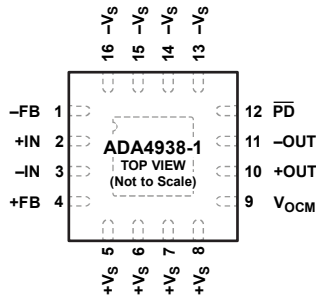

NOTES
 1. THE EXPOSED PAD IS NOT ELECTRICALLY CONNECTED TO THE DEVICE. IT IS TYPICALLY SOLDERED TO GROUND OR A POWER PLANE ON THE PCB THAT IS THERMALLY CONDUCTIVE.

06932-003

Figure 5. ADA4938-1 Pin Configuration

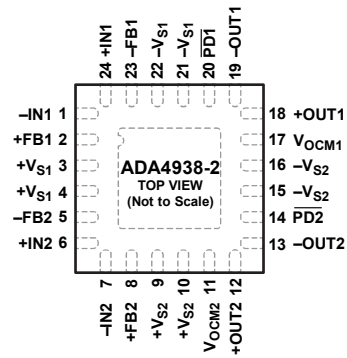

NOTES
 1. THE EXPOSED PAD IS NOT ELECTRICALLY CONNECTED TO THE DEVICE. IT IS TYPICALLY SOLDERED TO GROUND OR A POWER PLANE ON THE PCB THAT IS THERMALLY CONDUCTIVE.

06932-006

Figure 6. ADA4938-2 Pin Configuration

Table 7. ADA4938-1 Pin Function Descriptions

| Pin No. | Mnemonic | Description |
|----------|------------------|---|
| 1 | -FB | Negative Output Feedback Pin. |
| 2 | +IN | Positive Input Summing Node. |
| 3 | -IN | Negative Input Summing Node. |
| 4 | +FB | Positive Output Feedback Pin. |
| 5 to 8 | +Vs | Positive Supply Voltage. |
| 9 | V _{OCM} | Output Common-Mode Voltage. |
| 10 | +OUT | Positive Output for Load Connection. |
| 11 | -OUT | Negative Output for Load Connection. |
| 12 | PD | Power-Down Pin. |
| 13 to 16 | -Vs | Negative Supply Voltage. |
| EP | | Exposed Paddle. The exposed pad is not electrically connected to the device. It is typically soldered to ground or a power plane on the PCB that is thermally conductive. |

Table 8. ADA4938-2 Pin Function Descriptions

| Pin No. | Mnemonic | Description |
|---------|-------------------|---|
| 1 | -IN1 | Negative Input Summing Node 1. |
| 2 | +FB1 | Positive Output Feedback Pin 1. |
| 3, 4 | +Vs ₁ | Positive Supply Voltage 1. |
| 5 | -FB2 | Negative Output Feedback Pin 2. |
| 6 | +IN2 | Positive Input Summing Node 2. |
| 7 | -IN2 | Negative Input Summing Node 2. |
| 8 | +FB2 | Positive Output Feedback Pin 2. |
| 9, 10 | +Vs ₂ | Positive Supply Voltage 2. |
| 11 | V _{OCM2} | Output Common-Mode Voltage 2. |
| 12 | +OUT2 | Positive Output 2. |
| 13 | -OUT2 | Negative Output 2. |
| 14 | PD2 | Power-Down Pin 2. |
| 15, 16 | -Vs ₂ | Negative Supply Voltage 2. |
| 17 | V _{OCM1} | Output Common-Mode Voltage 1. |
| 18 | +OUT1 | Positive Output 1. |
| 19 | -OUT1 | Negative Output 1. |
| 20 | PD1 | Power-Down Pin 1. |
| 21, 22 | -Vs ₁ | Negative Supply Voltage 1. |
| 23 | -FB1 | Negative Output Feedback Pin 1. |
| 24 | +IN1 | Positive Input Summing Node 1. |
| EP | | Exposed Paddle. The exposed pad is not electrically connected to the device. It is typically soldered to ground or a power plane on the PCB that is thermally conductive. |

TYPICAL PERFORMANCE CHARACTERISTICS

$T_A = 25^\circ\text{C}$, $+V_S = 5\text{ V}$, $-V_S = -5\text{ V}$, $V_{\text{OCM}} = 0\text{ V}$, $R_T = 61.9\ \Omega$, $R_G = R_F = 200\ \Omega$, $G = +1$, $R_{L,\text{dm}} = 1\text{ k}\Omega$, unless otherwise noted.

All measurements were performed with single-ended input and differential output, unless otherwise noted. For gains other than $G = +1$, values for R_F and R_G are shown in Table 11.

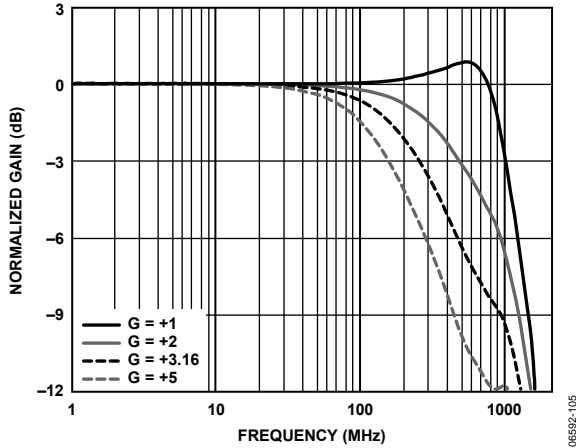

Figure 7. Small Signal Frequency Response for Various Gains, $V_{\text{OUT}} = 0.1\text{ V p-p}$

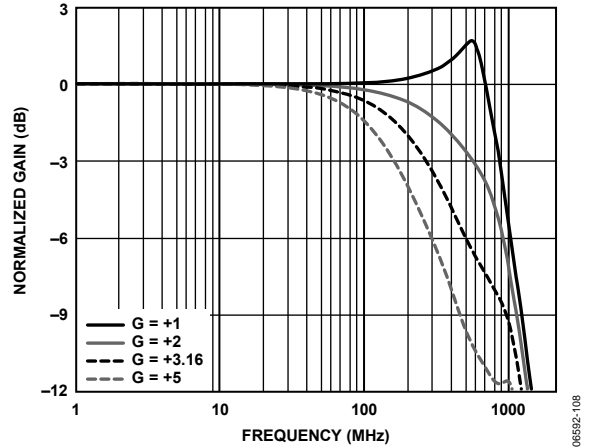

Figure 10. Large Signal Frequency Response for Various Gains

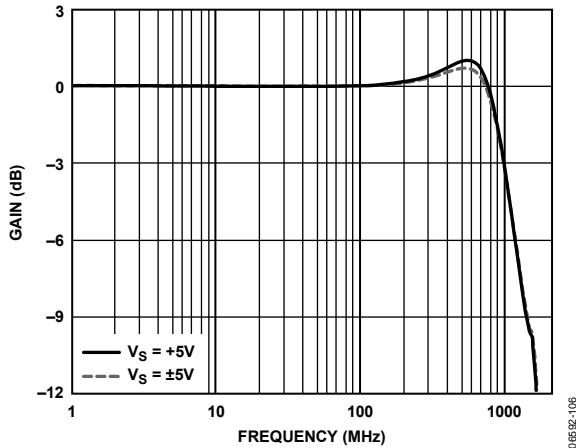

Figure 8. Small Signal Response for Various Supplies, $V_{\text{OUT}} = 0.1\text{ V p-p}$

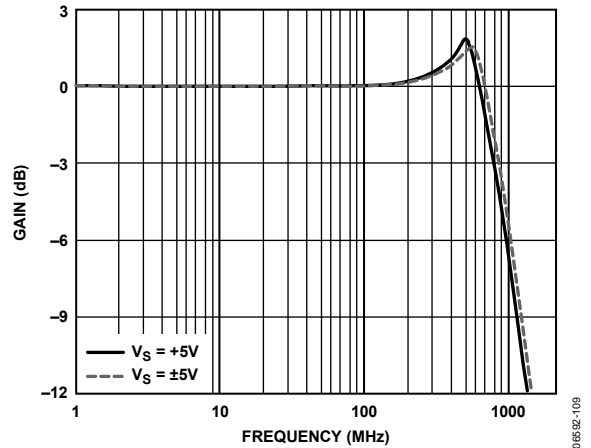

Figure 11. Large Signal Response for Various Supplies

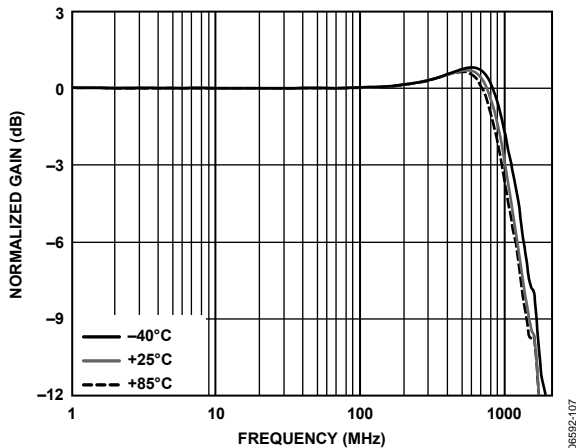

Figure 9. Small Signal Frequency Response for Various Temperatures, $V_{\text{OUT}} = 0.1\text{ V p-p}$

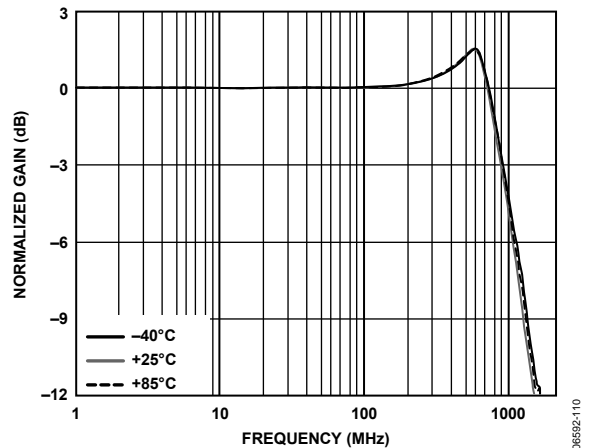

Figure 12. Large Signal Frequency Response for Various Temperatures

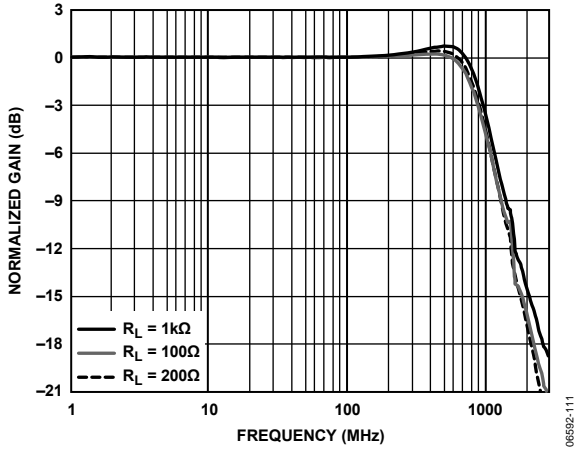

Figure 13. Small Signal Frequency Response for Various Loads, $V_{OUT} = 0.1 \text{ V p-p}$

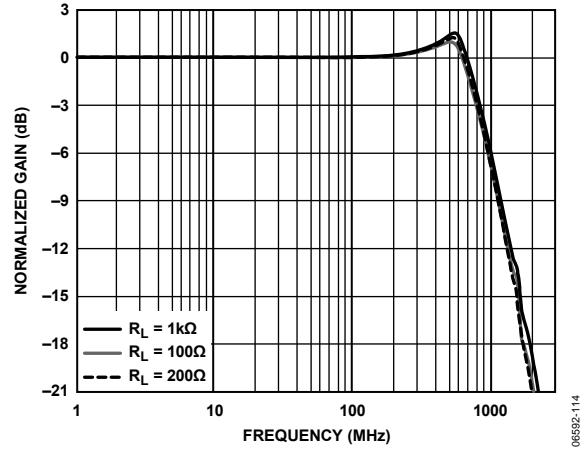

Figure 16. Large Signal Frequency Response for Various Loads

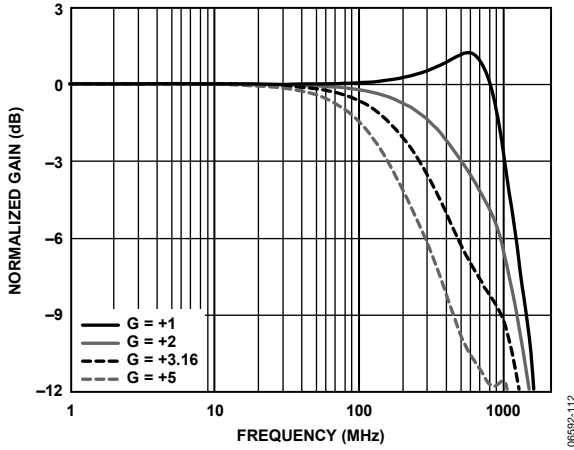

Figure 14. Small Signal Frequency Response for Various Gains, $V_S = 5 \text{ V}$, $V_{OUT} = 0.1 \text{ V p-p}$

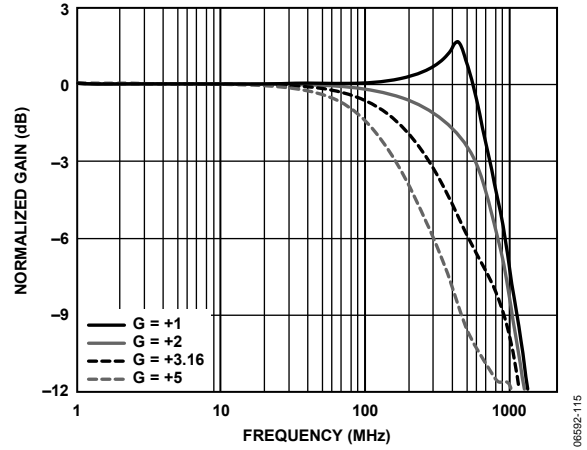

Figure 17. Large Signal Frequency Response for Various Gains, $V_S = 5 \text{ V}$

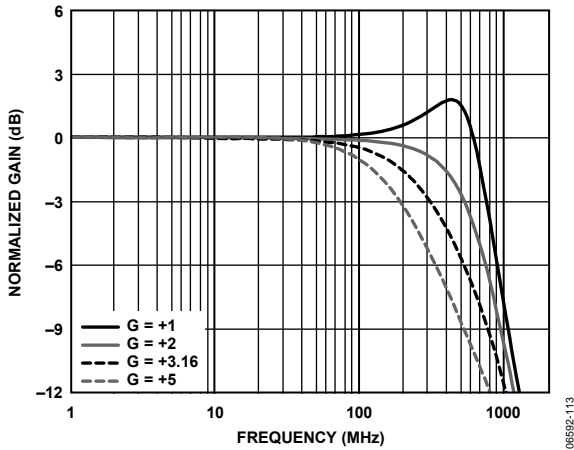

Figure 15. Small Signal Response for Various Gains, $R_F = 402 \Omega$, $V_{OUT} = 0.1 \text{ V p-p}$

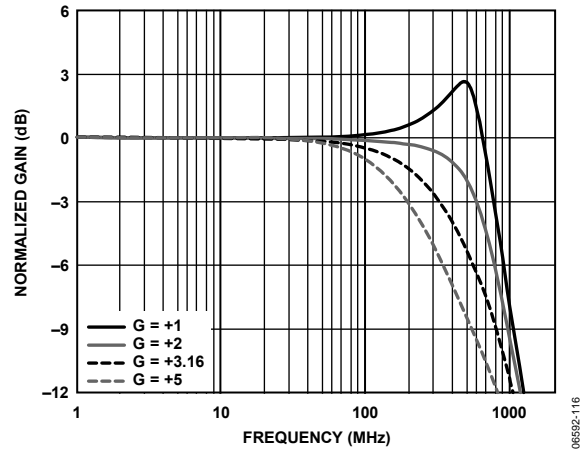

Figure 18. Large Signal Response for Various Gains, $R_F = 402 \Omega$

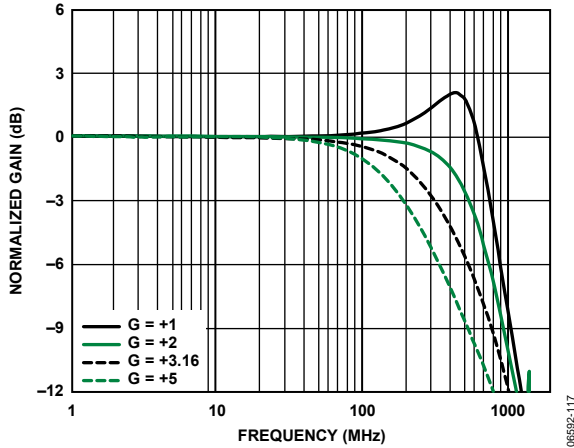

Figure 19. Small Signal Frequency Response for Various Gains, $R_F = 402 \Omega$, $V_S = 5 V$, $V_{OUT} = 0.1 V p-p$

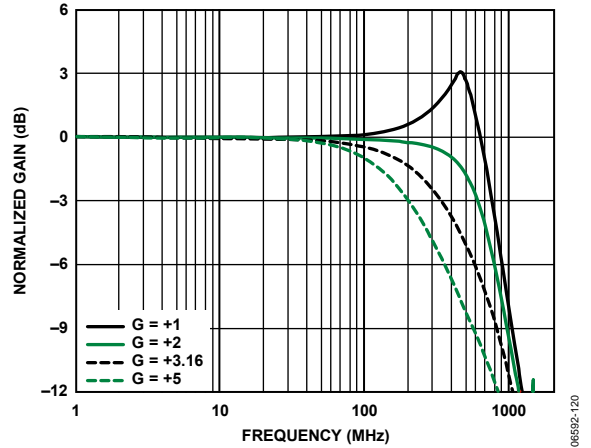

Figure 22. Large Signal Frequency Response for Various Gains, $R_F = 402 \Omega$, $V_S = 5 V$

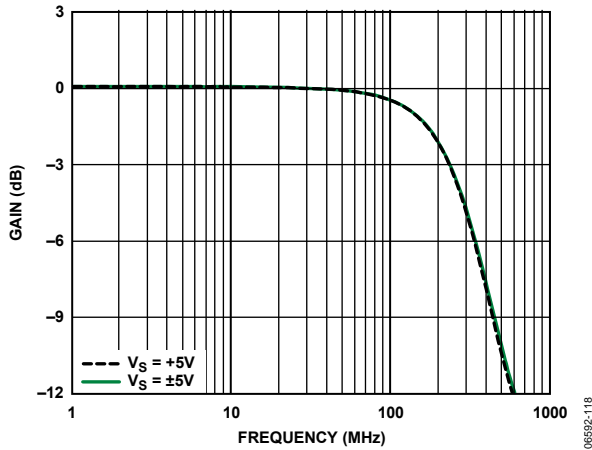

Figure 20. $V_{OUT,cm}$ Small Signal Frequency Response, $V_{OUT} = 0.1 V p-p$

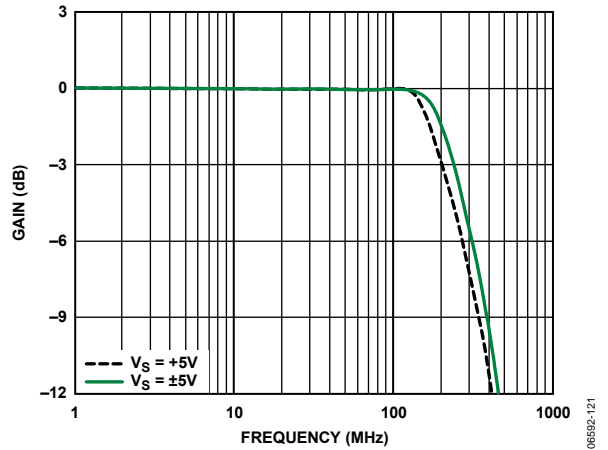

Figure 23. $V_{OUT,cm}$ Large Signal Frequency Response

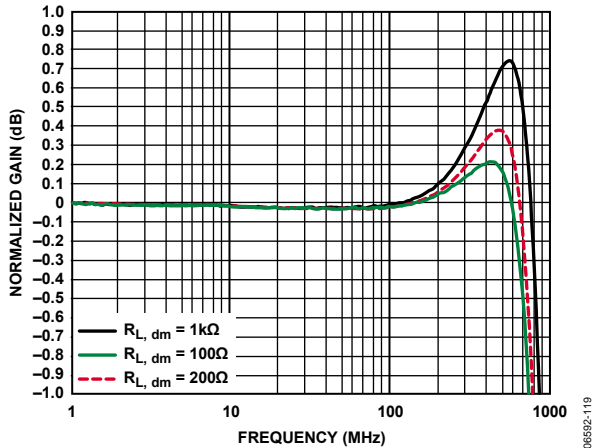

Figure 21. 0.1 dB Flatness Response for Various Loads, ADA4938-1, $V_{OUT} = 0.1 V p-p$

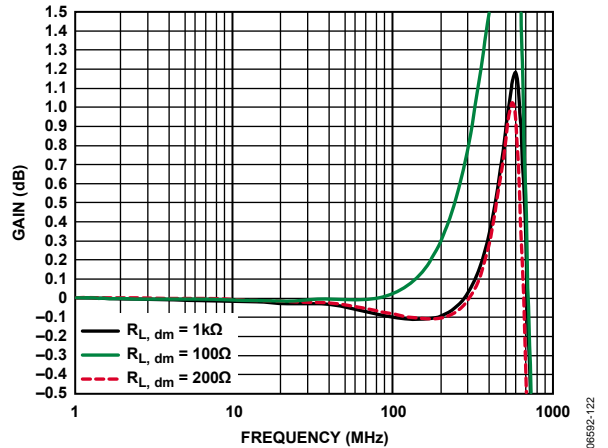

Figure 24. 0.1 dB Flatness Response for Various Loads, ADA4938-2, $V_{OUT} = 0.1 V p-p$

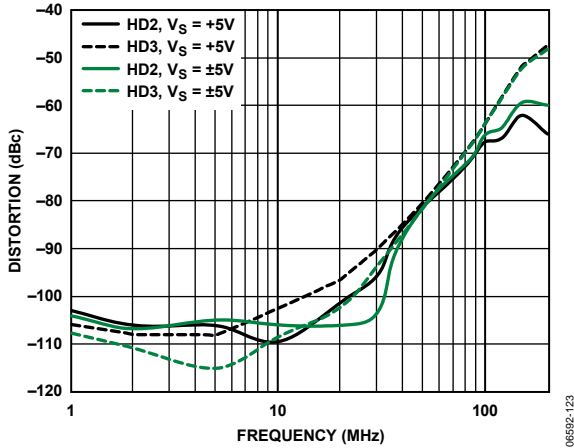

Figure 25. Harmonic Distortion vs. Frequency and Supply Voltage

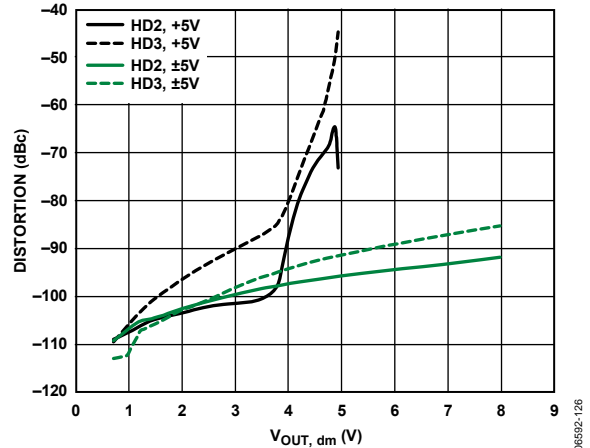

Figure 28. Harmonic Distortion vs. V_{OUT} and Supply Voltage

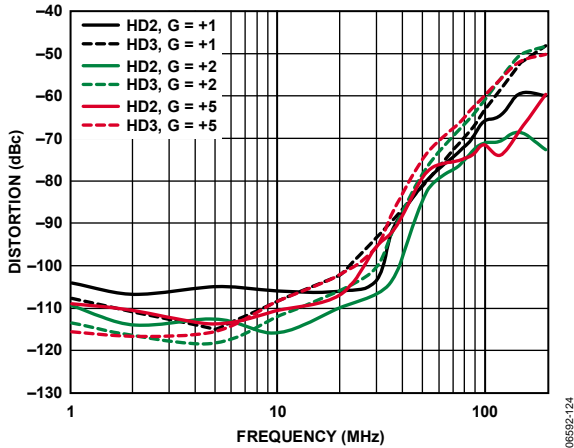

Figure 26. Harmonic Distortion vs. Frequency and Gain

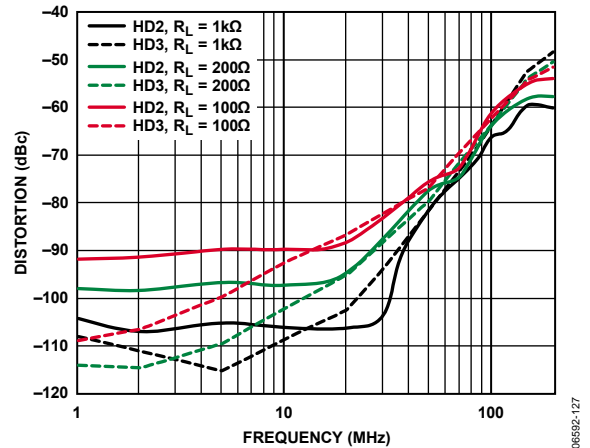

Figure 29. Harmonic Distortion vs. Frequency for Various Loads

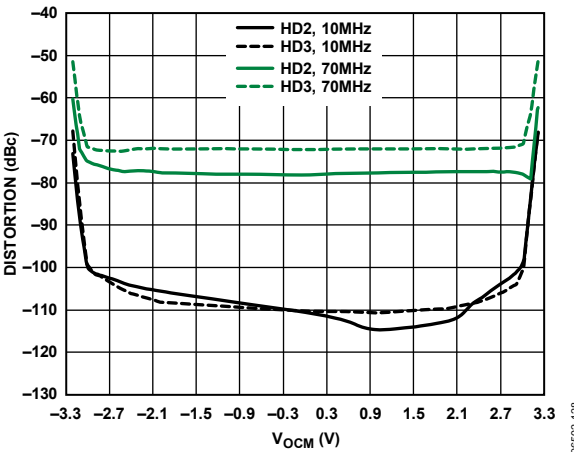

Figure 27. Harmonic Distortion vs. V_{OCM} and Frequency

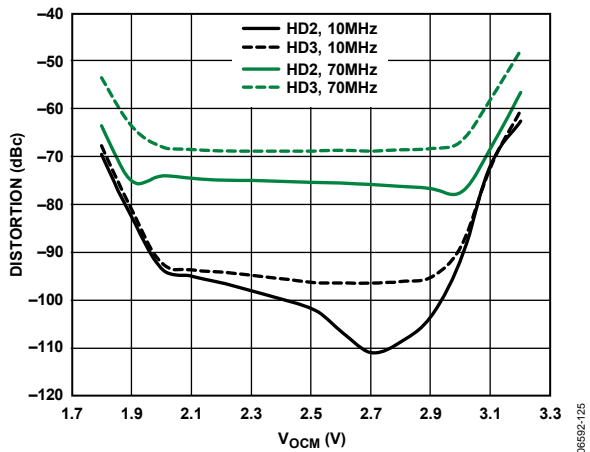

Figure 30. Harmonic Distortion vs. V_{OCM} and Frequency, $V_S = 5 V$

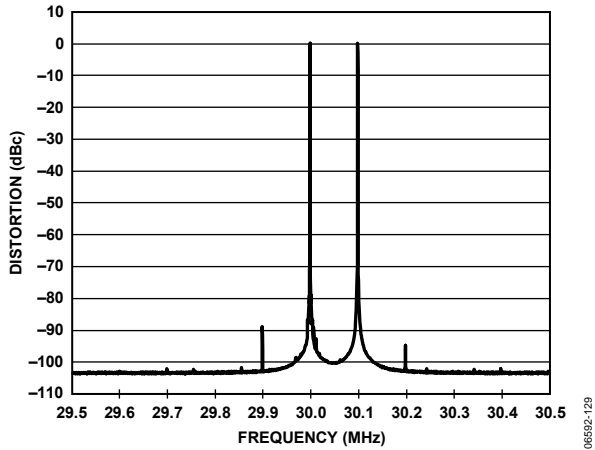

Figure 31. Intermodulation Distortion

06592-129

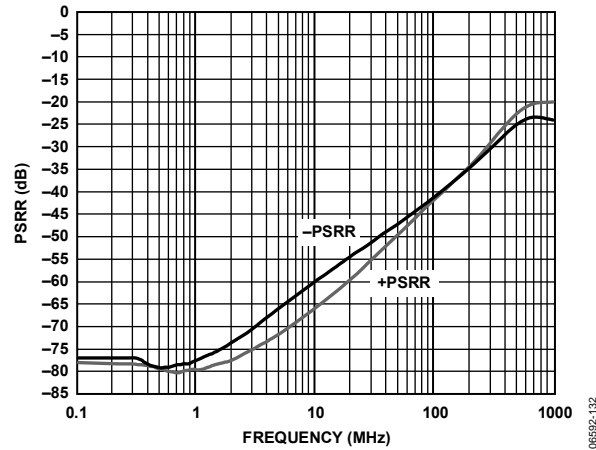

Figure 34. PSRR vs. Frequency

06592-132

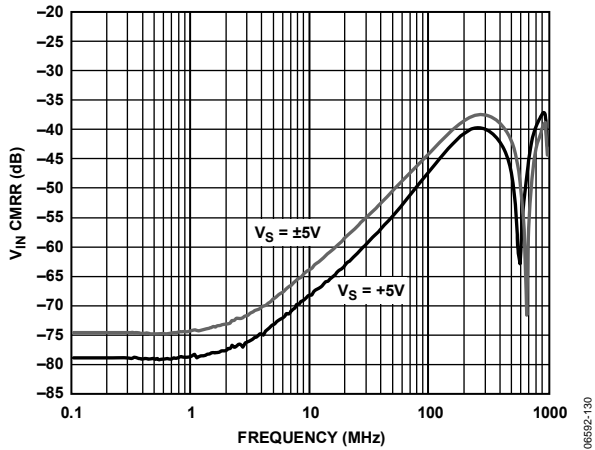

Figure 32. V_{IN} CMRR vs. Frequency

06592-130

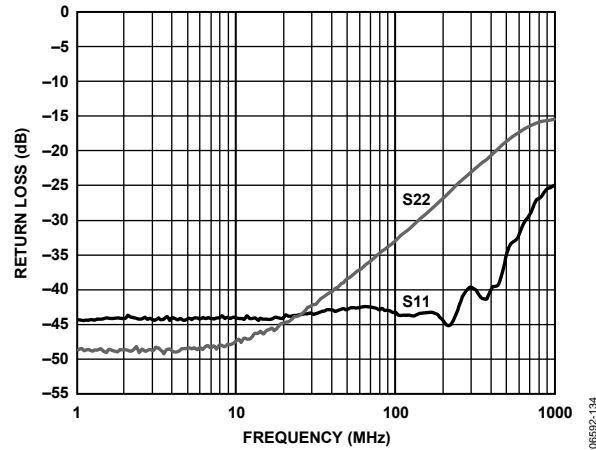

Figure 35. Return Loss (S_{11} , S_{22}) vs. Frequency

06592-134

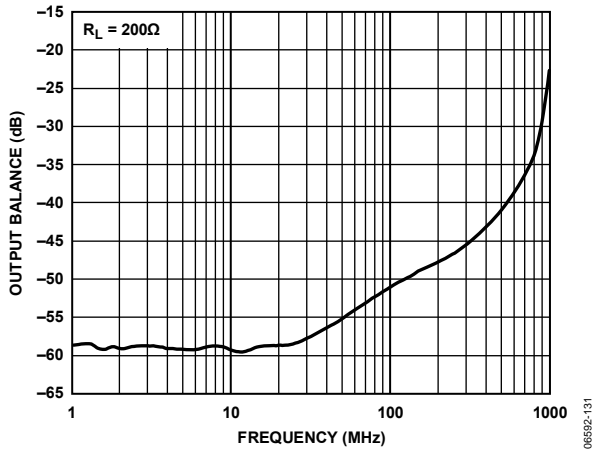

Figure 33. Output Balance vs. Frequency

06592-131

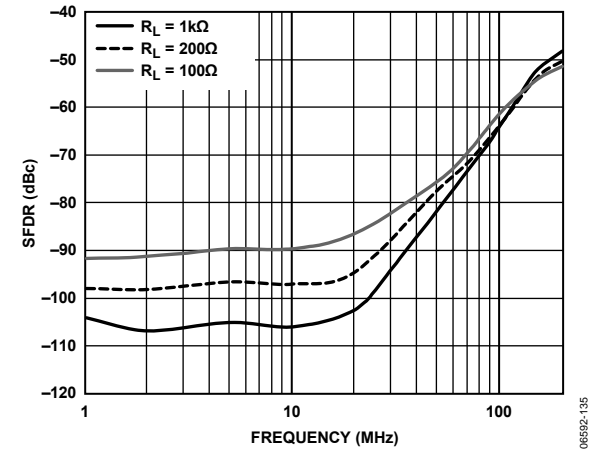

Figure 36. SFDR vs. Frequency for Various Loads

06592-135

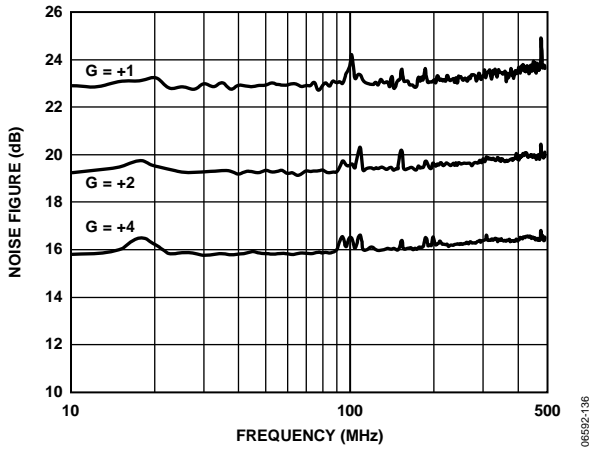

Figure 37. Noise Figure vs. Frequency

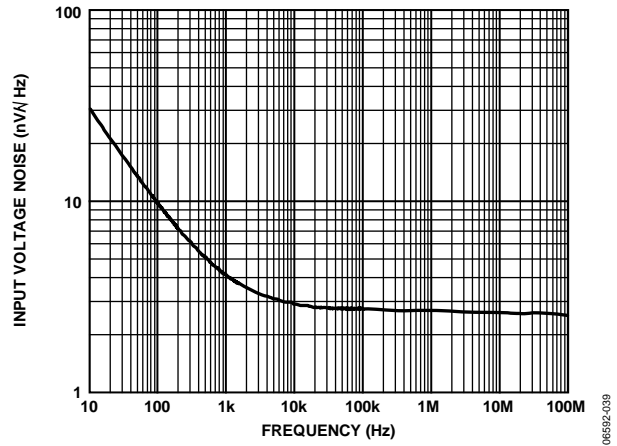

Figure 40. Input Voltage Noise vs. Frequency

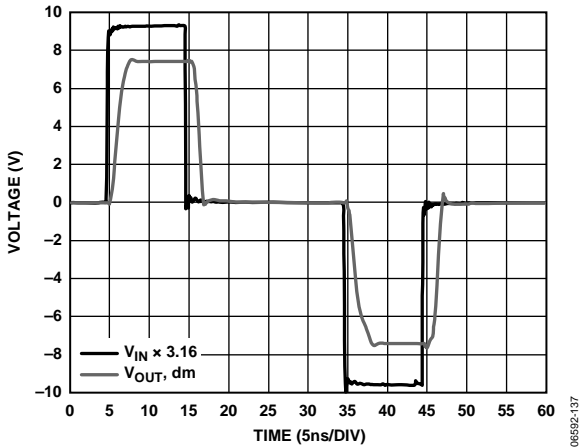

Figure 38. Overdrive Recovery Time (Pulse Input)

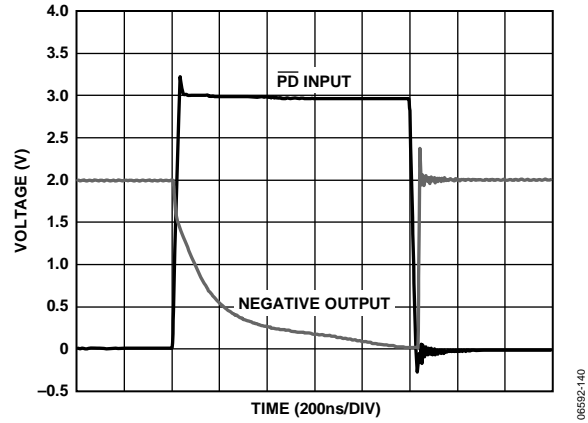

Figure 41. Power-Down Response Time

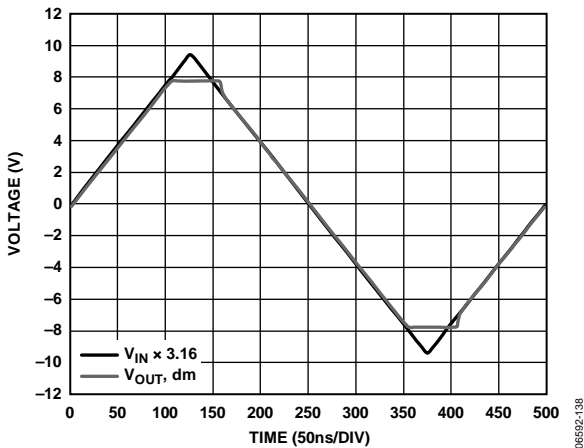

Figure 39. Overdrive Amplitude Characteristics (Triangle Wave Input)

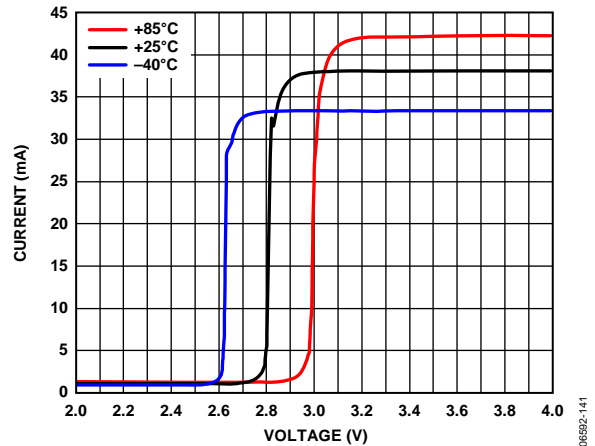

Figure 42. Supply Current vs. Power-Down Voltage and Temperature

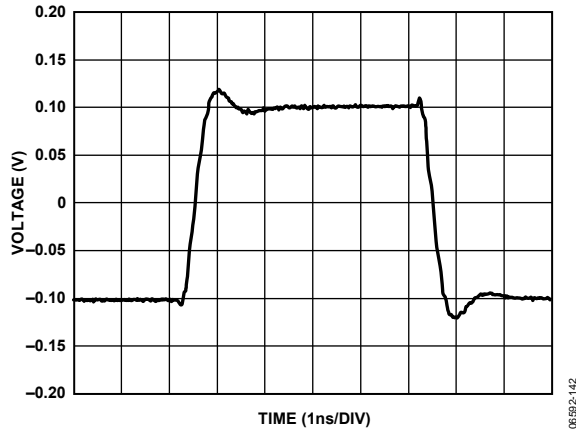

Figure 43. Small Signal Transient Response, $V_{OUT} = 0.1\text{ V p-p}$

06592-142

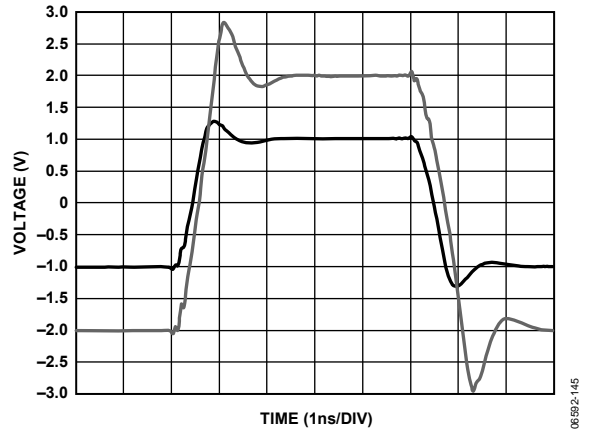

Figure 46. Large Signal Transient Response

06592-145

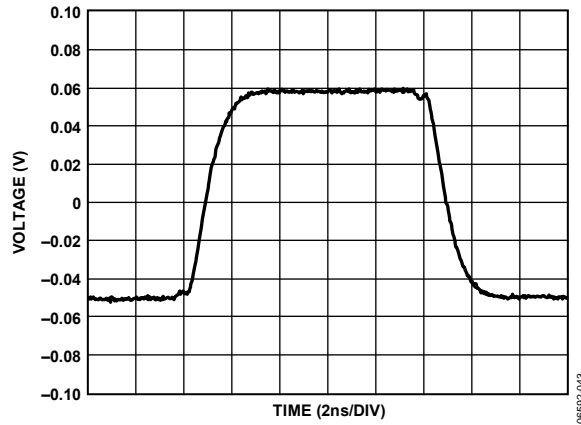

Figure 44. V_{OCM} Small Signal Transient Response, $V_{OUT} = 0.1\text{ V p-p}$

06592-043

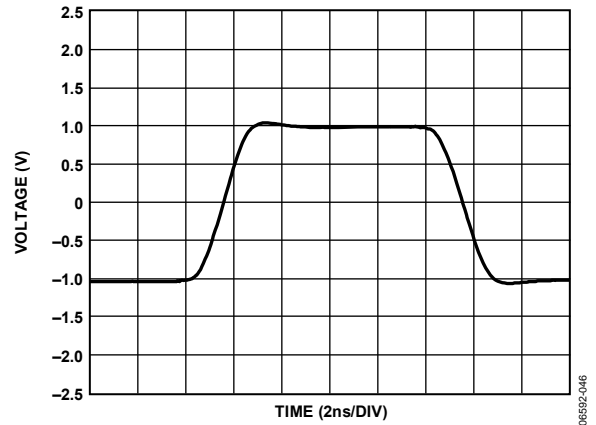

Figure 47. V_{OCM} Large Signal Transient Response

06592-046

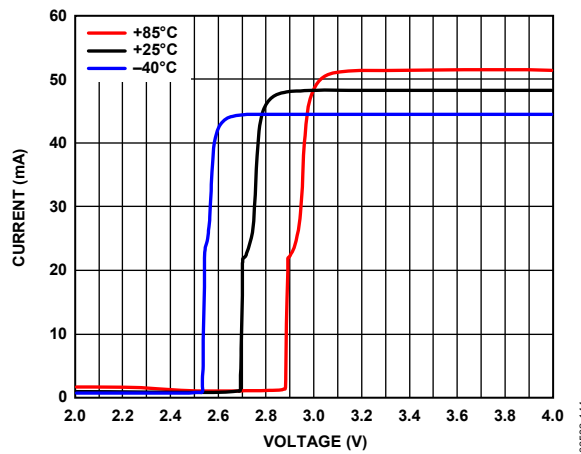

Figure 45. Supply Current vs. Power-Down Voltage and Temperature, $V_S = 5\text{ V}$

06592-144

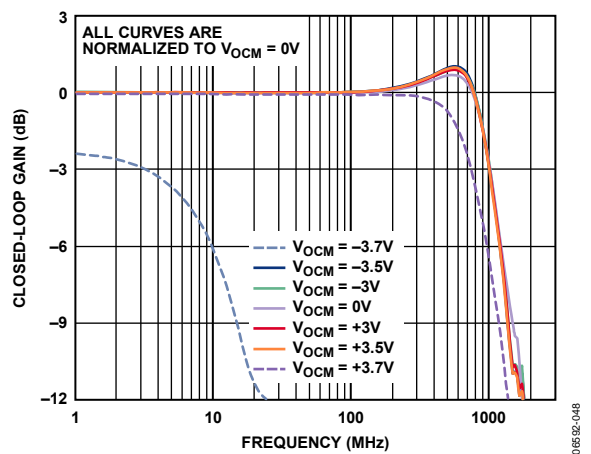

Figure 48. $V_{OUT,dm}$ Small Signal Frequency Response for Various V_{OCM} , $V_{OUT} = 0.1\text{ V p-p}$

06592-048

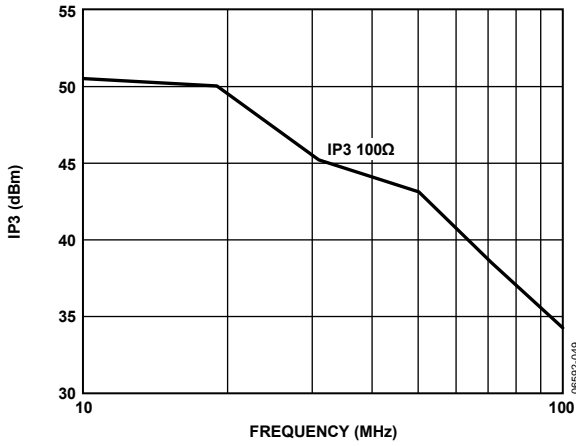

Figure 49. IP3 vs. Frequency

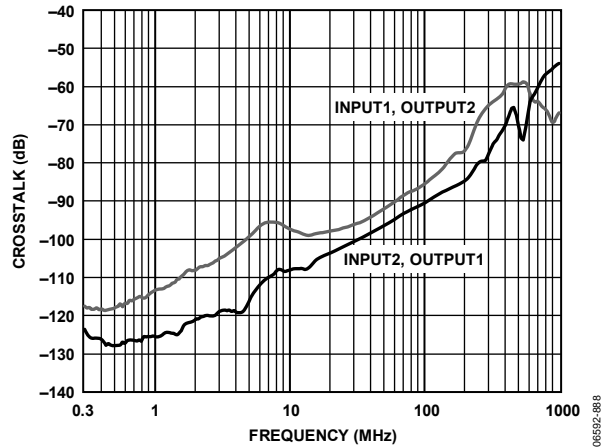

Figure 52. Crosstalk vs. Frequency for ADA4938-2

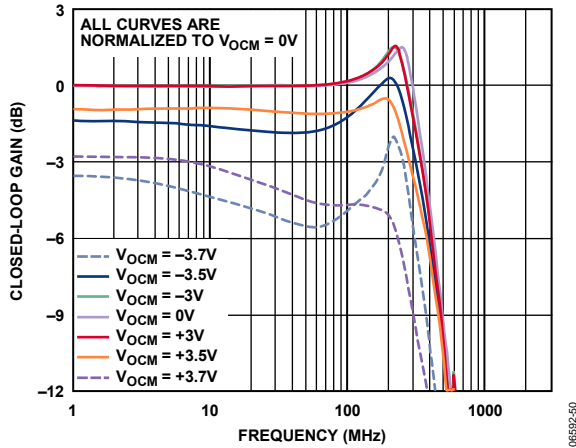

Figure 50. $V_{OUT, dm}$ Large Signal Frequency Response for Various V_{OCM}

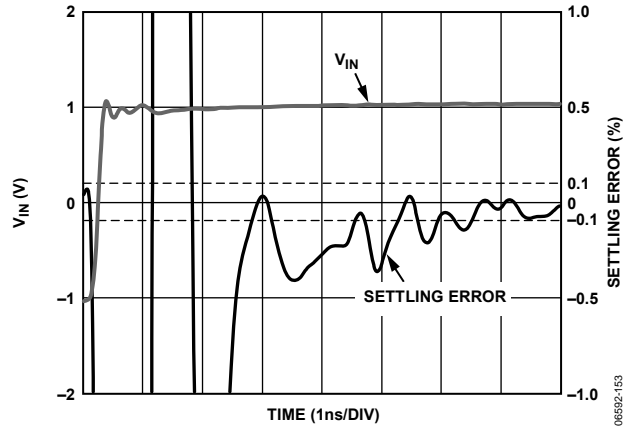

Figure 53. 0.1% Settling Time

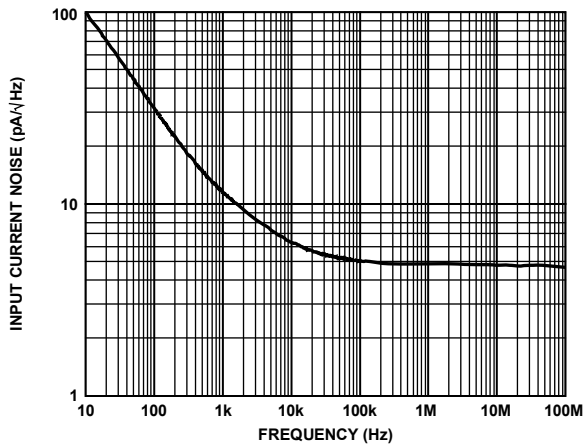

Figure 51. Input Current Noise vs. Frequency

TEST CIRCUITS

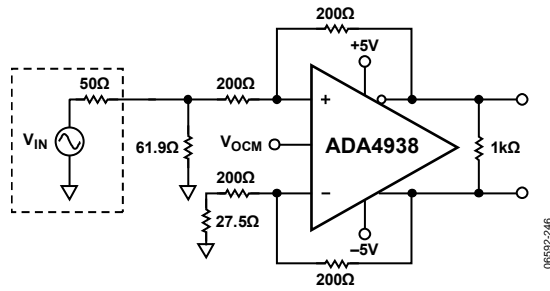

Figure 54. Equivalent Basic Test Circuit

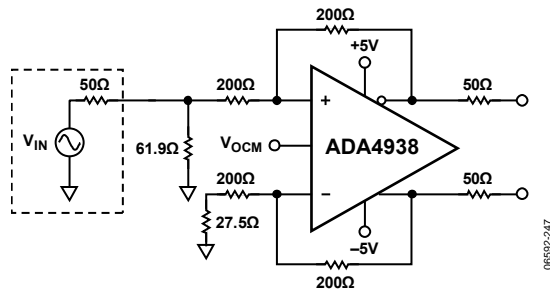

Figure 55. Test Circuit for Output Balance

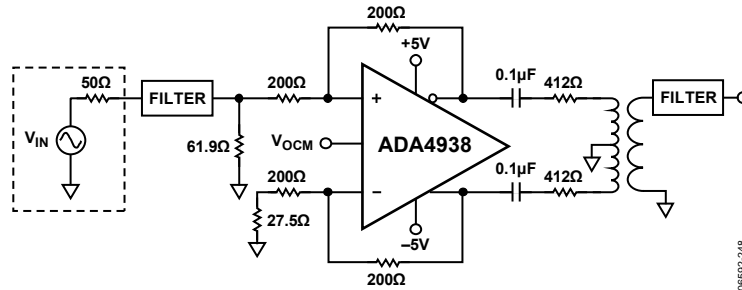

Figure 56. Test Circuit for Distortion Measurements

TERMINOLOGY

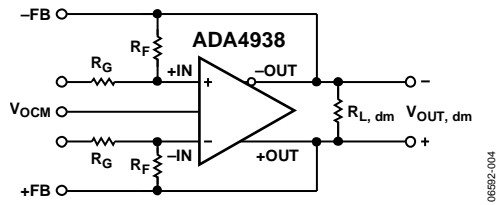

Figure 57. Circuit Definitions

Differential Voltage

The differential voltage is the difference between two node voltages. For example, the output differential voltage (or equivalently, output differential-mode voltage) is defined as

$$V_{OUT, dm} = (V_{+OUT} - V_{-OUT})$$

where V_{+OUT} and V_{-OUT} refer to the voltages at the +OUT and -OUT terminals with respect to a common reference.

Common-Mode Voltage

The common-mode voltage is the average of two node voltages. The output common-mode voltage is defined as

$$V_{OUT, cm} = (V_{+OUT} + V_{-OUT})/2$$

Balance

Balance is a measure of how well differential signals are matched in amplitude and are exactly 180° apart in phase. Balance is most easily determined by placing a well-matched resistor divider between the differential voltage nodes and comparing the magnitude of the signal at the midpoint of the divider with the magnitude of the differential signal. By this definition, output balance is the magnitude of the output common-mode voltage divided by the magnitude of the output differential mode voltage.

$$\text{Output Balance Error} = \left| \frac{V_{OUT, cm}}{V_{OUT, dm}} \right|$$

THEORY OF OPERATION

The ADA4938-1/ADA4938-2 differ from conventional op amps in that they have two outputs whose voltages move in opposite directions. Like an op amp, it relies on open-loop gain and negative feedback to force these outputs to the desired voltages. The ADA4938-1/ADA4938-2 behave much like a standard voltage feedback op amp and makes it easier to perform single-ended-to-differential conversions, common-mode level shifting, and amplifications of differential signals. Also like an op amp, the ADA4938-1/ADA4938-2 have high input impedance and low output impedance.

Two feedback loops are employed to control the differential and common-mode output voltages. The differential feedback, set with external resistors, controls only the differential output voltage. The common-mode feedback controls only the common-mode output voltage. This architecture makes it easy to set the output common-mode level to any arbitrary value. It is forced, by internal common-mode feedback, to be equal to the voltage applied to the V_{OCM} input, without affecting the differential output voltage.

The ADA4938-1/ADA4938-2 architecture results in outputs that are highly balanced over a wide frequency range without requiring tightly matched external components. The common-mode feedback loop forces the signal component of the output common-mode voltage to zero, which results in nearly perfectly balanced differential outputs that are identical in amplitude and are exactly 180° apart in phase.

ANALYZING AN APPLICATION CIRCUIT

The ADA4938-1/ADA4938-2 use open-loop gain and negative feedback to force its differential and common-mode output voltages in such a way as to minimize the differential and common-mode error voltages. The differential error voltage is defined as the voltage between the differential inputs labeled +IN and -IN (see Figure 57). For most purposes, this voltage can be assumed to be zero. Similarly, the difference between the actual output common-mode voltage and the voltage applied to V_{OCM} can also be assumed to be zero. Starting from these two assumptions, any application circuit can be analyzed.

SETTING THE CLOSED-LOOP GAIN

The differential-mode gain of the circuit in Figure 57 can be determined by

$$\left| \frac{V_{OUT, dm}}{V_{IN, dm}} \right| = \frac{R_F}{R_G}$$

This assumes the input resistors (R_G) and feedback resistors (R_F) on each side are equal.

ESTIMATING THE OUTPUT NOISE VOLTAGE

The differential output noise of the ADA4938-1/ADA4938-2 can be estimated using the noise model in Figure 58. The input-referred noise voltage density, v_{nIN}, is modeled as a differential input, and the noise currents, i_{nIN-} and i_{nIN+}, appear between each input and ground. The noise currents are assumed to be equal and produce a voltage across the parallel combination of the gain and feedback resistances. v_{n, cm} is the noise voltage density at the V_{OCM} pin. Each of the four resistors contributes (4kTR)^{1/2}. Table 9 summarizes the input noise sources, the multiplication factors, and the output-referred noise density terms.

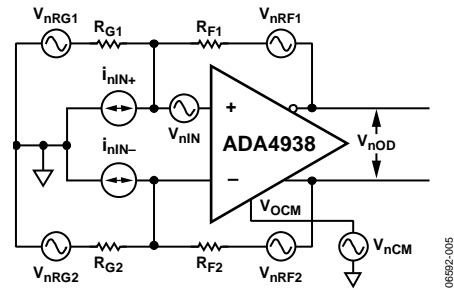

Figure 58. ADA4938-1/ADA4938-2 Noise Model

Table 9. Output Noise Voltage Density Calculations

| Input Noise Contribution | Input Noise Term | Input Noise Voltage Density | Output Multiplication Factor | Output Noise Voltage Density Term |
|------------------------------------|--------------------|---|---|---|
| Differential Input | V _{nIN} | V _{nIN} | G _N | V _{nO1} = G _N (V _{nIN}) |
| Inverting Input | i _{nIN-} | i _{nIN-} × (R _{G2} R _{F2}) | G _N | V _{nO2} = G _N [i _{nIN-} × (R _{G2} R _{F2})] |
| Noninverting Input | i _{nIN+} | i _{nIN+} × (R _{G1} R _{F1}) | G _N | V _{nO3} = G _N [i _{nIN+} × (R _{G1} R _{F1})] |
| V _{OCM} Input | V _{n, cm} | V _{n, cm} | G _N (β ₁ - β ₂) | V _{nO4} = G _N (β ₁ - β ₂)(V _{nCM}) |
| Gain Resistor, R _{G1} | V _{nRG1} | (4kTR _{G1}) ^{1/2} | G _N (1 - β ₁) | V _{nO5} = G _N (1 - β ₁)(4kTR _{G1}) ^{1/2} |
| Gain Resistor, R _{G2} | V _{nRG2} | (4kTR _{G2}) ^{1/2} | G _N (1 - β ₂) | V _{nO6} = G _N (1 - β ₂)(4kTR _{G2}) ^{1/2} |
| Feedback Resistor, R _{F1} | V _{nRF1} | (4kTR _{F1}) ^{1/2} | 1 | V _{nO7} = (4kTR _{F1}) ^{1/2} |
| Feedback Resistor, R _{F2} | V _{nRF2} | (4kTR _{F2}) ^{1/2} | 1 | V _{nO8} = (4kTR _{F2}) ^{1/2} |

Similar to the case of a conventional op amp, the output noise voltage densities can be estimated by multiplying the input-referred terms at +IN and -IN by the appropriate output factor, where:

$$G_N = \frac{2}{(\beta_1 + \beta_2)}$$
 is the circuit noise gain.

$$\beta_1 = \frac{R_{G1}}{R_{F1} + R_{G1}} \text{ and } \beta_2 = \frac{R_{G2}}{R_{F2} + R_{G2}}$$
 are the feedback factors.

When $R_{F1}/R_{G1} = R_{F2}/R_{G2}$, $\beta_1 = \beta_2 = \beta$, and the noise gain becomes

$$G_N = \frac{1}{\beta} = 1 + \frac{R_F}{R_G}$$

Note that the output noise from V_{OCM} goes to zero in this case. The total differential output noise density, v_{nOD} , is the root-sum-square of the individual output noise terms.

$$v_{nOD} = \sqrt{\sum_{i=1}^8 v_{nOi}^2}$$

THE IMPACT OF MISMATCHES IN THE FEEDBACK NETWORKS

As previously mentioned, even if the external feedback networks (R_F/R_G) are mismatched, the internal common-mode feedback loop still forces the outputs to remain balanced. The amplitudes of the signals at each output remain equal and 180° out of phase. The input-to-output, differential mode gain varies proportionately to the feedback mismatch, but the output balance is unaffected.

As well as causing a noise contribution from V_{OCM} , ratio matching errors in the external resistors result in a degradation of the ability of the circuit to reject input common-mode signals, much the same as for a four-resistor difference amplifier made from a conventional op amp.

In addition, if the dc levels of the input and output common-mode voltages are different, matching errors result in a small differential-mode output offset voltage. When $G = +1$, with a ground referenced input signal and the output common-mode level set to 2.5 V, an output offset of as much as 25 mV (1% of the difference in common-mode levels) can result if 1% tolerance resistors are used. Resistors of 1% tolerance result in a worst-case input CMRR of about 40 dB, a worst-case differential-mode output offset of 25 mV due to 2.5 V level-shift, and no significant degradation in output balance error.

CALCULATING THE INPUT IMPEDANCE OF AN APPLICATION CIRCUIT

The effective input impedance of a circuit depends on whether the amplifier is being driven by a single-ended or differential signal source. For balanced differential input signals, as shown in Figure 59, the input impedance ($R_{IN, dm}$) between the inputs (+D_{IN} and -D_{IN}) is simply $R_{IN, dm} = 2 \times R_G$.

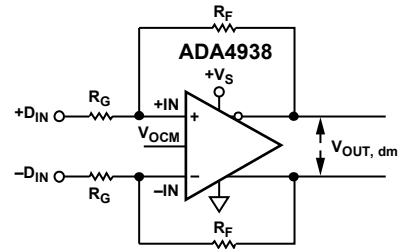

Figure 59. ADA4938-1/ADA4938-2 Configured for Balanced (Differential) Inputs

For an unbalanced, single-ended input signal (see Figure 60), the input impedance is

$$R_{IN, cm} = \left(\frac{R_G}{1 - \frac{R_F}{2 \times (R_G + R_F)}} \right)$$

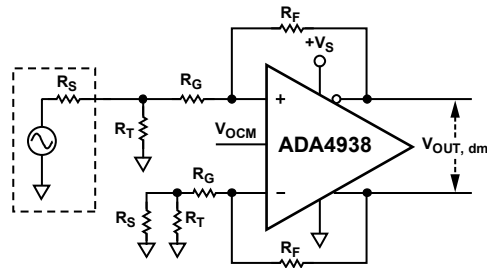

Figure 60. ADA4938-1/ADA4938-2 Configured for Unbalanced (Single-Ended) Input

The input impedance of the circuit is effectively higher than it would be for a conventional op amp connected as an inverter because a fraction of the differential output voltage appears at the inputs as a common-mode signal, partially bootstrapping the voltage across the Input Gain Resistor R_G .

INPUT COMMON-MODE VOLTAGE RANGE IN SINGLE-SUPPLY APPLICATIONS

The ADA4938-1/ADA4938-2 is optimized for level-shifting, ground-referenced input signals. As such, the center of the input common-mode range is shifted approximately 1 V down from midsupply. The input common-mode range at the summing nodes of the amplifier is from 0.3 V above $-V_S$ to 1.6 V below $+V_S$. To avoid clipping at the outputs, the voltage swing at the +IN and -IN terminals must be confined to these ranges.

TERMINATING A SINGLE-ENDED INPUT

Using an example with an input source of 2 V, a source resistance of 50 Ω, and an overall gain of 1 V/V, four simple steps must be followed to terminate a single-ended input to the ADA4938-1/ADA4938-2.

1. The input impedance is calculated using the formula

$$R_{IN} = \left(\frac{R_G}{1 - \frac{R_F}{2 \times (R_G + R_F)}} \right) = \left(\frac{200}{1 - \frac{200}{2 \times (200 + 200)}} \right) = 267 \Omega$$

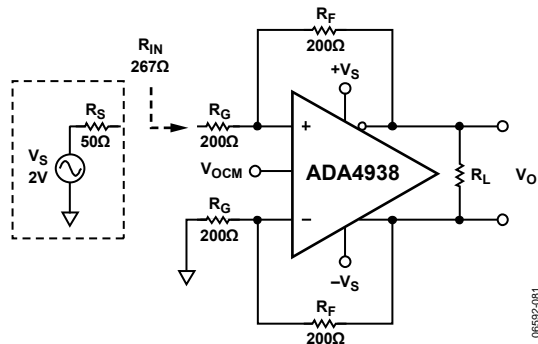

Figure 61. Single-Ended Input Impedance

2. To provide a 50 Ω termination for the source, the Resistor RT is calculated such that RT || RIN = 50 Ω, or RT = 61.9 Ω.

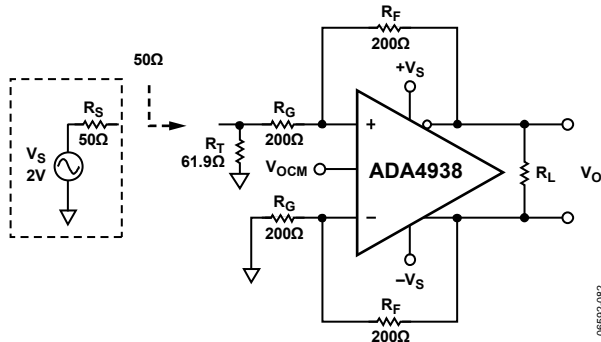

Figure 62. Adding Termination Resistor RT

3. To compensate for the imbalance of the gain resistors, a correction resistor (RTS) is added in series with the inverting Input Gain Resistor RG. RTS is equal to the Thevenin equivalent of the source resistance (RS || RT).

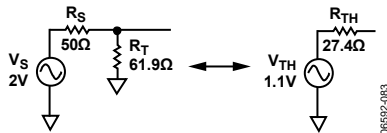

Figure 63. Calculating Thevenin Equivalent

RTS = RTH = RS || RT = 27.4 Ω. Note that VTH is not equal to VS/2, which would be the case if the amplifier circuit did not affect the termination.

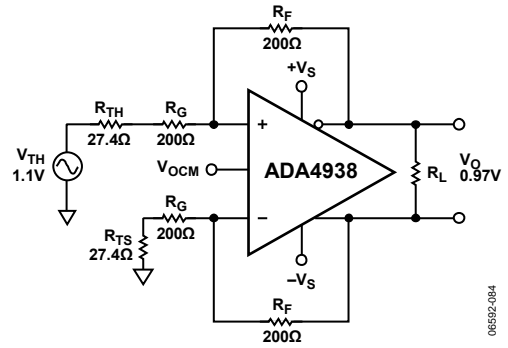

Figure 64. Balancing Gain Resistor RG

4. Finally, the feedback resistor is recalculated to adjust the output voltage to the desired level.

a. To make the output voltage Vo = 1 V, RF is calculated using

$$R_F = \left(\frac{V_O \times (R_G + R_{TS})}{V_{TH}} \right) = \left(\frac{1 \times (200 + 27.4)}{1.1} \right) = 207 \Omega$$

b. To return the overall gain to 1 V/V (Vo = Vs = 2 V), RF should be

$$R_F = \left(\frac{V_O \times (R_G + R_{TS})}{V_{TH}} \right) = \left(\frac{2 \times (200 + 27.4)}{1.1} \right) = 414 \Omega$$

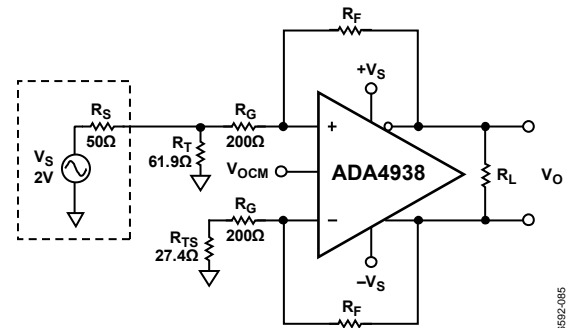

Figure 65. Complete Single-Ended-to-Differential System

SETTING THE OUTPUT COMMON-MODE VOLTAGE

The VOCM pin of the ADA4938-1/ADA4938-2 is internally biased at a voltage approximately equal to the midsupply point (average value of the voltages on V+ and V-). Relying on this internal bias results in an output common-mode voltage that is within about 100 mV of the expected value.

In cases where more accurate control of the output common-mode level is required, it is recommended that an external source or resistor divider (10 kΩ or greater resistors) be used.

It is also possible to connect the VOCM input to a common-mode level (CML) output of an ADC. However, care must be taken to ensure that the output has sufficient drive capability. The input impedance of the VOCM pin is approximately 10 kΩ. If multiple ADA4938-1/ADA4938-2 devices share one reference output, it is recommended that a buffer be used.

Table 10 and Table 11 list several common gain settings, associated resistor values, input impedances, and output noise densities for both balanced and unbalanced input configurations. Also shown

are the input common-mode voltages under the given conditions for different V_{OCM} settings for both a 10 V single supply and ± 5 V dual supplies.

Table 10. Differential Ground-Referenced Input, DC-Coupled; See Figure 59

| Nominal Gain (V/V) | R_F (Ω) | R_G (Ω) | $R_{IN, dm}$ (Ω) | Differential Output Noise Density (nV/ \sqrt{Hz}) | Common-Mode Level at +IN, -IN (V) | | | |
|--------------------|--------------------|--------------------|---------------------------|--|---|--------------------------|---|--------------------------|
| | | | | | $+V_S = 10\text{ V}, -V_S = 0\text{ V}$ $V_{OUT, dm} = 2.0\text{ V p-p}$ | | $+V_S = 5\text{ V}, -V_S = -5\text{ V}$ $V_{OUT, dm} = 2.0\text{ V p-p}$ | |
| | | | | | $V_{OCM} = 2.5\text{ V}$ | $V_{OCM} = 3.5\text{ V}$ | $V_{OCM} = 1.0\text{ V}$ | $V_{OCM} = 3.2\text{ V}$ |
| 1 | 200 | 200 | 400 | 6.5 | 1.25 | 1.75 | 0.50 | 1.60 |
| 2 | 402 | 200 | 400 | 10.4 | 0.83 | 1.16 | 0.33 | 1.06 |
| 3.16 | 402 | 127 | 254 | 13.4 | 0.60 | 0.84 | 0.24 | 0.77 |
| 5 | 402 | 80.6 | 161 | 18.2 | 0.42 | 0.58 | 0.17 | 0.53 |

Table 11. Single-Ended Ground-Referenced Input, DC-Coupled, $R_S = 50\ \Omega$; See Figure 60

| Nominal Gain (V/V) | R_F (Ω) | R_{G1} (Ω) | R_T (Ω) | $R_{IN, se}$ (Ω) | R_{G2} (Ω) ¹ | Overall Gain (V/V) ² | Differential Output Noise Density (nV/ \sqrt{Hz}) | Common-Mode Swing at +IN, -IN (V) | | | |
|--------------------|--------------------|-----------------------|--------------------|---------------------------|------------------------------------|---------------------------------|--|---|--------------------------|---|--------------------------|
| | | | | | | | | $+V_S = 10\text{ V}, -V_S = 0\text{ V}$ $V_{OUT, dm} = 2.0\text{ V p-p}$ | | $+V_S = 5\text{ V}, -V_S = -5\text{ V}$ $V_{OUT, dm} = 2.0\text{ V p-p}$ | |
| | | | | | | | | $V_{OCM} = 2.5\text{ V}$ | $V_{OCM} = 3.5\text{ V}$ | $V_{OCM} = 0\text{ V}$ | $V_{OCM} = 2.0\text{ V}$ |
| 1 | 200 | 200 | 60.4 | 267 | 226 | 0.9 | 6.2 | 1.00 to 1.50 | 1.50 to 2.00 | -0.25 to +0.25 | 0.75 to 1.25 |
| 2 | 402 | 200 | 60.4 | 300 | 226 | 1.8 | 9.8 | 0.66 to 1.00 | 1.00 to 1.33 | -0.17 to +0.17 | 0.50 to 0.83 |
| 3.16 | 402 | 127 | 66.5 | 205 | 158 | 2.5 | 11.8 | 0.48 to 0.72 | 0.72 to 0.96 | -0.12 to +0.12 | 0.36 to 0.60 |
| 5 | 402 | 80.6 | 76.8 | 138 | 110 | 3.6 | 14.7 | 0.33 to 0.50 | 0.50 to 0.67 | -0.08 to +0.08 | 0.25 to 0.42 |

¹ $R_{G2} = R_{G1} + R_{TS}$.

² Includes effects of termination match.

LAYOUT, GROUNDING, AND BYPASSING

As high speed devices, the ADA4938-1/ADA4938-2 are sensitive to the PCB environment in which it operates. Realizing its superior performance requires attention to the details of high speed PCB design.

The first requirement is a solid ground plane that covers as much of the board area around the ADA4938-1/ADA4938-2 as possible. However, the area near the feedback resistors (R_F), input gain resistors (R_G), and the input summing nodes should be cleared of all ground and power planes (see Figure 66). Clearing the ground and power planes minimizes any stray capacitance at these nodes and prevents peaking of the response of the amplifier at high frequencies.

The thermal resistance, θ_{JA} , is specified for the device, including the exposed pad, soldered to a high thermal conductivity 4-layer circuit board, as described in EIA/JESD 51-7. The exposed pad is electrically isolated from the device; therefore, it can be connected to a ground plane using vias. Examples of the thermal attach pad and via structure for the ADA4938-1 are shown in Figure 67 and Figure 68.

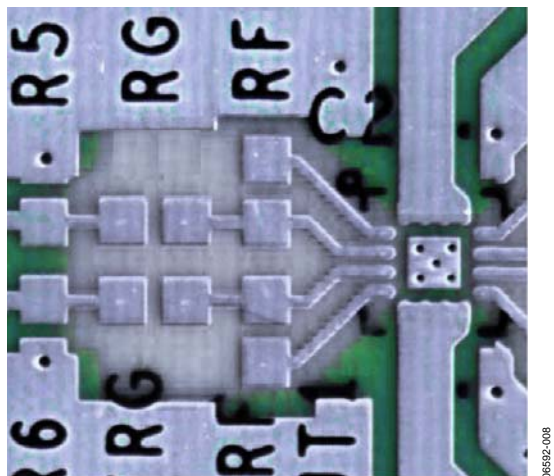

Figure 66. Ground and Power Plane Voiding in Vicinity of R_F and R_G

Bypass the power supply pins as close to the device as possible and directly to a nearby ground plane. Use high frequency ceramic chip capacitors. It is recommended that two parallel bypass capacitors (1000 pF and 0.1 μ F) be used for each supply with the 1000 pF capacitor placed closer to the device; if further away, provide low frequency bypassing using 10 μ F tantalum capacitors from each supply to ground.

Signal routing should be short and direct to avoid parasitic effects. Wherever complementary signals exist, provide a symmetrical layout to maximize balanced performance.

When routing differential signals over a long distance, keep PCB traces close together and twist any differential wiring to minimize loop area. Doing this reduces radiated energy and makes the circuit less susceptible to interference.

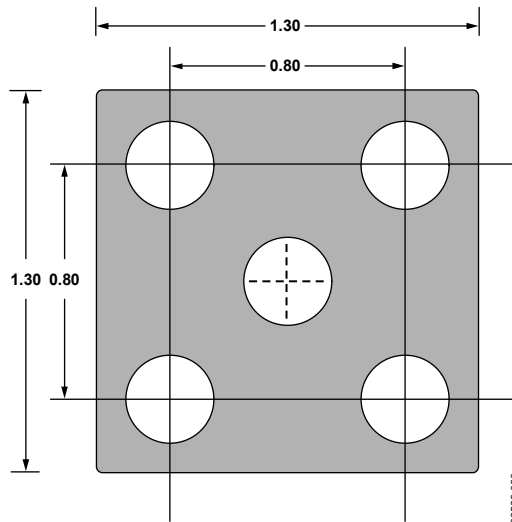

Figure 67. Recommended PCB Thermal Attach Pad (ADA4938-1) (Dimensions in mm)

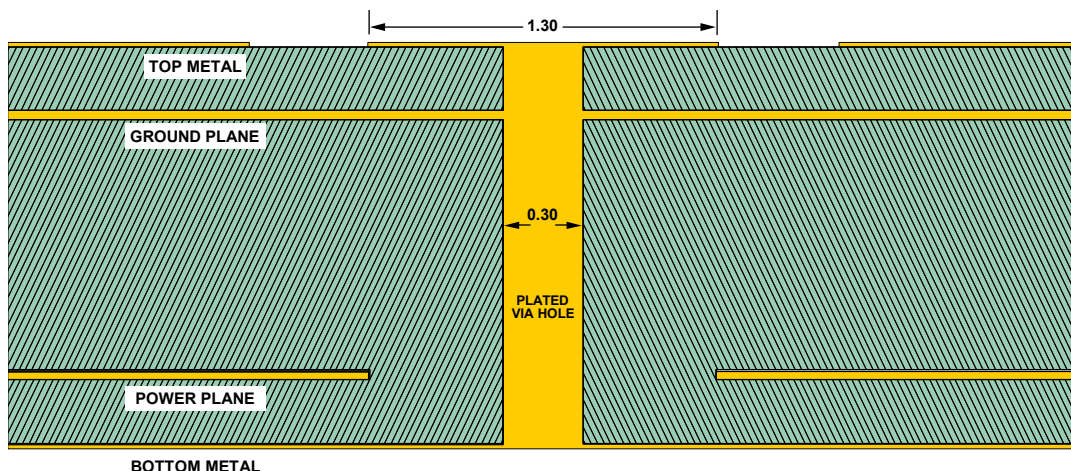

Figure 68. Cross-Section of a 4-Layer PCB (ADA4938-1) Showing a Thermal Via Connection to the Buried Ground Plane (Dimensions in mm)

HIGH PERFORMANCE ADC DRIVING

The ADA4938-1/ADA4938-2 are ideally suited for dc-coupled baseband applications. The circuit in Figure 69 shows a front-end connection for an ADA4938-1/ADA4938-2 driving an AD9446, 16-bit, 80 MSPS ADC. The AD9446 achieves its optimum performance when it is driven differentially. The ADA4938-1/ADA4938-2 eliminate the need for a transformer to drive the ADC, performs a single-ended-to-differential conversion, buffers the driving signal, and provides appropriate level shifting for dc coupling.

The ADA4938-1/ADA4938-2 are configured with a single 10 V supply and unity gain for a single-ended input to differential output. The 61.9 Ω termination resistor, in parallel with the single-ended input impedance of 267 Ω, provides a 50 Ω termination for the source. The additional 26 Ω (226 Ω total) at the inverting input balances the parallel impedance of the 50 Ω source and the termination resistor driving the noninverting input.

The signal generator has a symmetric, ground-referenced bipolar output. The V_{OCM} pin of the ADA4938-1/ADA4938-2 is biased with an external resistor divider to obtain the desired 3.5 V output common-mode. One-half of the common-mode voltage is fed back to the summing nodes, biasing -IN and +IN at 1.75 V. For a common-mode voltage of 3.5 V, each ADA4938-1/ADA4938-2 output swings between 2.7 V and 4.3 V, providing a 3.2 V p-p differential output.

The output of the amplifier is dc-coupled to the ADC through a second-order, low-pass filter with a -3 dB frequency of 50 MHz. The filter reduces the noise bandwidth of the amplifier and isolates the driver outputs from the ADC inputs.

The AD9446 is configured for a 4.0 V p-p full-scale input by setting R1 = R2 = 1 kΩ between the VREF pin and SENSE pin in Figure 69.

The circuit in Figure 70 shows a simplified front-end connection for an ADA4938-1/ADA4938-2 driving an AD9246, 14-bit, 125 MSPS ADC. The AD9246 achieves its optimum performance when it is driven differentially. The ADA4938-1/ADA4938-2 eliminate the need for a transformer to drive the ADC, performs a single-ended-to-differential conversion, buffers the driving signal, and provides appropriate level shifting for dc coupling.

The ADA4938-1/ADA4938-2 are configured with dual ±5 V supplies and a gain of ~2 V/V for a single-ended input to differential output. The 76.8 Ω termination resistor, in parallel with the single-ended input impedance of 137 Ω, provides a 50 Ω dc termination for the source. The additional 30.1 Ω (120 Ω total) at the inverting input balances the parallel dc impedance of the 50 Ω source and the termination resistor driving the noninverting input.

The signal generator has a symmetric, ground-referenced bipolar output. The V_{OCM} pin of the ADA4938-1/ADA4938-2 is connected to the CML pin of the AD9246 to set the output common-mode level at the appropriate point. A portion of this is fed back to the summing nodes, biasing -IN and +IN at 0.55 V. For a common-mode voltage of 0.9 V, each ADA4938-1/ADA4938-2 output swings between 0.4 V and 1.4 V, providing a 2 V p-p differential output.

The output is dc-coupled to a single-pole, low-pass filter. The filter reduces the noise bandwidth of the amplifier and provides some level of isolation from the switched capacitor inputs of the ADC.

The AD9246 is set for a 2 V p-p full-scale input by connecting the SENSE pin to AGND. The inputs of the AD9246 are biased at 1 V by connecting the CML output, as shown in Figure 70.

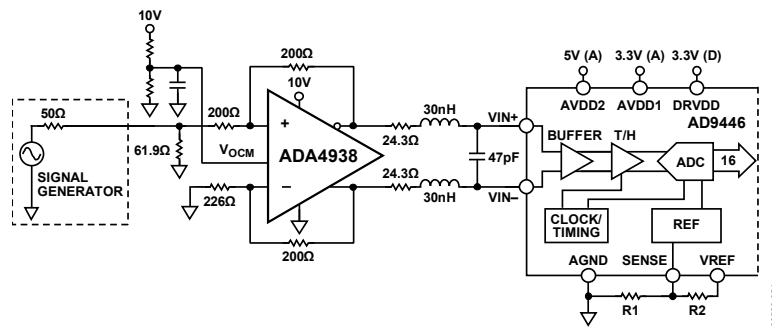

Figure 69. ADA4938-1/ADA4938-2 Driving an AD9446, 16-Bit, 80 MSPS ADC

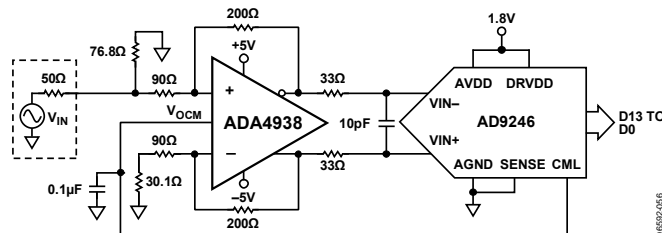
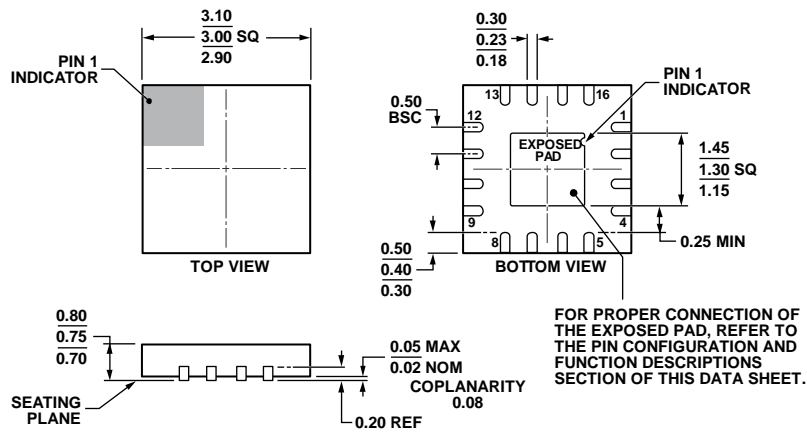

Figure 70. ADA4938-1/ADA4938-2 Driving an AD9246, a 14-Bit, 125 MSPS ADC

OUTLINE DIMENSIONS



COMPLIANT TO JEDEC STANDARDS MO-220-WEED.

Figure 71. 16-Lead Lead Frame Chip Scale Package [LFCSFP]
3 mm × 3 mm Body and 0.75 mm Package Height
(CP-16-21)
Dimensions shown in millimeters

111808-A

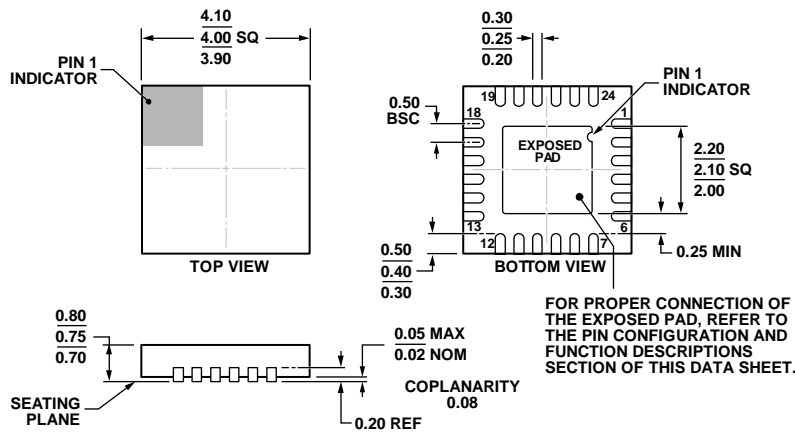

COMPLIANT TO JEDEC STANDARDS MO-220-WGGD-8.

Figure 72. 24-Lead Lead Frame Chip Scale Package [LFCSFP]
4 mm × 4 mm Body, and 0.75 mm Package Height
(CP-24-10)
Dimensions shown in millimeters

06-11-2012-A

ORDERING GUIDE

| Model ¹ | Temperature Range | Package Description | Package Option | Ordering Quantity | Branding |
|--------------------|-------------------|---------------------|----------------|-------------------|----------|
| ADA4938-1ACPZ-R2 | -40°C to +85°C | 16-Lead LFCSFP | CP-16-21 | 250 | H11 |
| ADA4938-1ACPZ-RL | -40°C to +85°C | 16-Lead LFCSFP | CP-16-21 | 5,000 | H11 |
| ADA4938-1ACPZ-R7 | -40°C to +85°C | 16-Lead LFCSFP | CP-16-21 | 1,500 | H11 |
| ADA4938-2ACPZ-R2 | -40°C to +85°C | 24-Lead LFCSFP | CP-24-10 | 250 | |
| ADA4938-2ACPZ-RL | -40°C to +85°C | 24-Lead LFCSFP | CP-24-10 | 5,000 | |
| ADA4938-2ACPZ-R7 | -40°C to +85°C | 24-Lead LFCSFP | CP-24-10 | 1,500 | |

¹ Z = RoHS Compliant Part

NOTES

X-ON Electronics

Largest Supplier of Electrical and Electronic Components

Click to view similar products for [Differential Amplifiers](#) category:

Click to view products by [Analog Devices](#) manufacturer:

Other Similar products are found below :

[LT6604IUUFF-2.5#PBF](#) [INA149AMDREP](#) [LT6600CS8-15#PBF](#) [LT6604IUUFF-15#PBF](#) [LT6604CUFF-5#PBF](#) [THS4552IRTWT](#) [LTC1992-2IMS8#PBF](#) [AD8138SRMZ-EP-R7](#) [LT6376IMS#PBF](#) [AD626ANZ](#) [AD626BNZ](#) [AD629ANZ](#) [AD629BNZ](#) [AD8129ARMZ](#) [AD8131ARMZ-REEL7](#) [AD8137WYCPZ-R7](#) [AD8138AARZ](#) [AD8138ARMZ](#) [AD8139ACPZ-REEL7](#) [AD8139ARDZ](#) [AD8139ARDZ-REEL7](#) [AD8202WYRMZ](#) [AD8203YRMZ](#) [AD8208WBRMZ](#) [AD8209AWBRMZ](#) [AD8209WBRMZ](#) [AD8209WHRMZ](#) [AD8274ARMZ](#) [AD8278ARMZ](#) [AD8278ARMZ-R7](#) [AD8278BRMZ-R7](#) [AD830ANZ](#) [AD8350ARMZ15](#) [AD8350ARMZ20](#) [AD8366ACPZ-R7](#) [AD8475BRMZ](#) [AD8476ACPZ-R7](#) [AD8476ARMZ-R7](#) [AD8476BCPZ-R7](#) [AD8476BCPZ-WP](#) [AD8147ACPZ-R2](#) [ADA4930-2YCPZ-R2](#) [ADA4938-2ACPZ-R7](#) [ADA4939-2YCPZ-R7](#) [AD8133ACPZ-R2](#) [AD8133ACPZ-REEL7](#) [AD8148ACPZ-R7](#) [ADA4930-2YCPZ-R7](#) [ADA4932-2YCPZ-R2](#) [ADA4937-2YCPZ-R7](#)