

FEATURES

- 600 MHz/1200 Mbps data rate**
- 3-level driver with high-Z and reflection clamps**
- Window and differential comparators**
- ±25 mA active load**
- Per pin PPMU with –2.0 V to +6.5 V range**
- Low leakage mode (typically 4 nA)**
- Integrated 16-bit DACs with offset and gain correction**
- High speed operating voltage range: –1.5 V to +6.5 V**
- Dedicated VHH output pin range: 0.0 V to 13.5 V**
- 1.1 W power dissipation per channel**
- Driver**
 - 3-level voltage range: –1.5 V to +6.5 V**
 - Precision trimmed output resistance**
 - Unterminated swing: 200 mV minimum to 8 V maximum**
 - 725 ps minimum pulse width, VIH – VIL = 2.0 V**
- Comparator**
 - Differential and single-ended window modes**
 - >1.2 GHz input equivalent bandwidth**
- Load**
 - ±25 mA current range**
- Per pin PPMU (PPMU)**
 - Force voltage/compliance range: –2.0 V to +6.5 V**
 - 5 current ranges: 40 mA, 1 mA, 100 µA, 10 µA, 2 µA**
 - External sense input for system PMU**
 - Go/no-go comparators**
- Levels**
 - Fully integrated 16-bit DACs**
 - On-chip gain and offset calibration registers and add/multiply engine**
- Package**
 - 84-lead 10 mm × 10 mm LFCSP (0.4 mm pitch)**

APPLICATIONS

- Automatic test equipment**
- Semiconductor test systems**
- Board test systems**
- Instrumentation and characterization equipment**

GENERAL DESCRIPTION

The [ADATE318](#) is a complete, single-chip ATE solution that performs the pin electronics functions of driver, comparator, and active load (DCL), four quadrant, per pin, parametric measurement unit (PPMU). It has VHH drive capability per chip to support flash memory testing applications and integrated 16-bit DACs with an on-chip calibration engine to provide all necessary dc levels for operation of the part.

The driver features three active states: data high, data low, and terminate mode, as well as a high impedance inhibit state. The inhibit state, in conjunction with the integrated dynamic clamps, facilitates the implementation of a high speed active termination. The output voltage capability is –1.5 V to +6.5 V to accommodate a wide range of ATE and instrumentation applications.

The [ADATE318](#) can be used as a dual, single-ended drive/receive channel or as a single differential drive/receive channel. Each channel of the [ADATE318](#) features a high speed window comparator as well as a programmable threshold differential comparator for differential ATE applications. A four quadrant PPMU is also provided per channel.

All dc levels for DCL and PPMU functions are generated by 24 on-chip 16-bit DACs. To facilitate accurate levels programming, the [ADATE318](#) contains an integrated calibration function to correct gain and offset errors for each functional block. Correction coefficients can be stored on chip, and any values written to the DACs are automatically adjusted using the appropriate correction factors.

The [ADATE318](#) uses a serial programmable interface (SPI) bus to program all functional blocks, DACs, and on-chip calibration constants. It also has an on-chip temperature sensor and over/undervoltage fault clamps for monitoring and reporting the device temperature and any output pin or PPMU voltage faults that may occur during operation.

TABLE OF CONTENTS

Features 1

Applications..... 1

General Description 1

Revision History 2

Functional Block Diagram 3

Specifications..... 4

 SPI Timing Details 22

Absolute Maximum Ratings..... 27

 Thermal Resistance 27

 ESD Caution..... 27

Pin Configuration and Function Descriptions..... 28

Typical Performance Characteristics 31

SPI Interconnect Details 49

Use of the SPI $\overline{\text{BUSY}}$ Pin..... 50

Reset Sequence and the $\overline{\text{RST}}$ Pin 51

SPI Register Definitions and Memory Map 52

Control Register Details 55

Level Setting DACs..... 63

 DAC Update Modes 63

 DAC Transfer Functions 67

 Gain and Offset Correction 68

 X₂ Registers..... 68

 Sample Calculations of m and c 68

Power Supply, Grounding, and Decoupling Strategy 70

User Information and Truth Tables 71

 Alarm Functions..... 72

 PPMU External Capacitors..... 72

 Temperature Sensor 72

 Default Test Conditions..... 73

Detailed Functional Block Diagrams..... 74

Outline Dimensions 80

 Ordering Guide 80

REVISION HISTORY

7/2017—Rev. A to Rev. B

Changes to Table 13..... 26

Changes to Figure 119..... 57

Updated Outline Dimensions 80

Changes to Ordering Guide 80

7/2011—Rev. 0 to Rev. A

Updated Outline Dimensions 80

4/2011—Revision 0: Initial Version

FUNCTIONAL BLOCK DIAGRAM

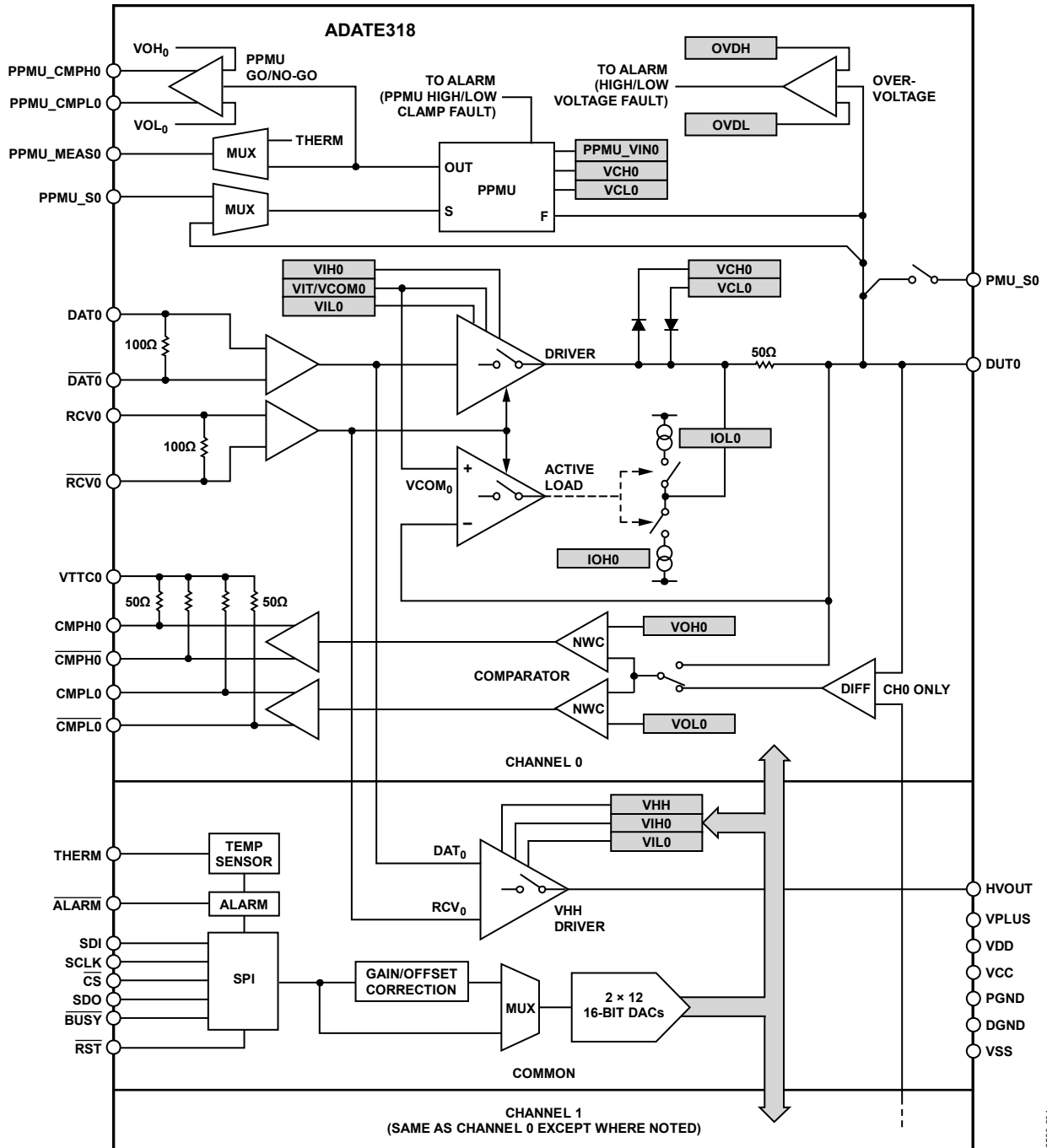

Figure 1.

09530-001

SPECIFICATIONS

VDD = +10.0 V, VCC = +2.5 V, VSS = -6.0 V, VPLUS = +16.75 V, VTTCx = +1.2 V, VREF = 5.000 V, VREFGND = 0.000 V. All test conditions are as defined in Table 32. All specified values are at T_J = 50°C, where T_J corresponds to the internal temperature sensor reading (THERM pin), unless otherwise noted. Temperature coefficients are measured around T_J = 50° ± 20°C, unless otherwise noted. Typical values are based on statistical mean of design, simulation analyses, and/or limited bench evaluation data. Typical values are neither tested nor guaranteed. See Table 16 for an explanation of test levels.

Table 1. Detailed Electrical Specifications

Parameter	Min	Typ	Max	Unit	Test Level	Conditions
TOTAL FUNCTION						
Output Leakage Current, DCL Disable						
PPMU Range E	-10.0	±4.0	+10.0	nA	P	-2.0 V < VDUTx < +6.5 V, PPMU and DCL disabled, PPMU Range E, VCL = -2.5 V, VCH = +7.5 V
PPMU Range A, Range B, Range C, and Range D		±4.0		nA	Cr	-2.0 V < VDUTx < +6.5 V, PPMU and DCL disabled, PPMU Range A, Range B, Range C, Range D, VCL = -2.5 V, VCH = +7.5 V
Output Leakage Current, Driver High-Z Mode	-2		+2	µA	P	-2.0 V < VDUTx < +7.0 V, PPMU disabled and DCL enabled, RCvX active, VCL = -2.5 V, VCH = +7.5 V
DUTx Pin Capacitance		1.2		pF	S	Drive VIT = 0.0 V
DUTx Pin Voltage Range	-2.0		+7.0	V	D	
POWER SUPPLIES						
Total Supply Range, VPLUS to VSS		22.75	23.55	V	D	
VPLUS Supply, VPLUS	15.90	16.75	17.60	V	D	Defines dc PSR conditions
Positive Supply, VDD	9.5	10.0	10.5	V	D	Defines dc PSR conditions
Negative Supply, VSS	-6.3	-6.0	-5.7	V	D	Defines dc PSR conditions
Logic Supply, VCC	2.3	2.5	3.5	V	D	Defines dc PSR conditions
Comparator Output Termination, VTTCx	0.5	1.2	3.3	V	D	
VPLUS Supply Current, VPLUS		1.1	2.5	mA	P	VHH pin disabled
	4.75	13.28	16.25	mA	P	VHH pin enabled, RCvX active, no load, VHH programmed level = 13.0 V
Logic Supply Current, VCC	-125	1	+125	µA	P	Quiescent (SPI is static); VCC = 2.5 V
		7.5		mA	S	Current drawn during clocked portion of device reset sequence
Termination Supply Current, VTTCx	30	45	50	mA	P	
Positive Supply Current, VDD	90	99	115	mA	P	Load power-down (IOH = IOL = 0 mA)
Negative Supply Current, VSS	155	172	185	mA	P	Load power-down (IOH = IOL = 0 mA)
Total Power Dissipation	1.9	2.1	2.3	W	P	Load power-down (IOH = IOL = 0 mA)
Positive Supply Current, VDD	145	174	210	mA	P	Load active off (IOH = IOL = 25 mA)
Negative Supply Current, VSS	210	246	280	mA	P	Load active off (IOH = IOL = 25 mA)
Total Power Dissipation	3.0	3.3	3.6	W	P	Load active off (IOH = IOL = 25 mA)
Positive Supply Current, VDD		167		mA	Cr	Load active off (IOH = IOL = 25 mA), calibrated
Negative Supply Current, VSS		238		mA	Cr	Load active off (IOH = IOL = 25 mA), calibrated
Total Power Dissipation		3.2		W	Cr	Load active off (IOH = IOL = 25 mA), calibrated
Positive Supply Current, VDD		109		mA	Cr	Load power-down, PPMU standby
Negative Supply Current, VSS		183		mA	Cr	Load power-down, PPMU standby
Total Power Dissipation		2.3		W	Cr	Load power-down, PPMU standby

Parameter	Min	Typ	Max	Unit	Test Level	Conditions
TEMPERATURE MONITOR						
Temperature Sensor Gain		10		mV/K	D	
Temperature Sensor Accuracy over Temperature Range		±6		K	C _T	
VREF INPUT REFERENCE						
DAC Reference Input Voltage Range (VREF Pin)	4.950	5.000	5.050	V	D	Provided externally: VREF pin = +5.000 V VREFGND pin = 0.000 V (not referenced to V _{DUTGND})
Input Bias Current			100	µA	P	Tested with 5.000 V applied
DUTGND INPUT						
Input Voltage Range, Referenced to AGND	-0.1		+0.1	V	D	
Input Bias Current	-100		+100	µA	P	Tested at -100 mV and +100 mV

Table 2. Driver (VIH – VIL ≥ 100 mV to Meet DC and AC Performance Specifications)

Parameter	Min	Typ	Max	Unit	Test Level	Conditions
DC SPECIFICATIONS						
High-Speed Differential Input Characteristics						
High Speed Input Termination Resistance: DATx, RCVx	92	100	108	Ω	P	Impedance between each pair of DATx and RCVx pins; push 4 mA into positive pin, force 0.8 V on negative pin, measure voltage between pins; calculate resistance ($\Delta V/\Delta I$)
Input Voltage Differential: DATx, RCVx	0.2	0.4	1.0	V	D	0.2 V < V _{DM} < 1.0 V
Input Voltage Range: DATx, RCVx	0.0		3.3	V	D	0.0 V < (V _{CM} ± V _{DM} /2) < 3.3 V
Output Characteristics						
Output High Range, VIH	-1.4		+6.5	V	D	
Output Low Range, VIL	-1.5		+6.4	V	D	
Output Term Range, VIT	-1.5		+6.5	V	D	
Functional Amplitude (VIH – VIL)	0.0	8.0		V	D	
DC Output Current Limit Source	75		130	mA	P	Drive high, VIH = +6.5 V, short DUTx pin to -1.5 V, measure current
DC Output Current Limit Sink	-130		-75	mA	P	Drive low, VIL = -1.5 V, short DUTx pin to +6.5 V, measure current
Output Resistance, ±40 mA	46	48.6	51	Ω	P	$\Delta V_{DUT}/\Delta I_{DUT}$; source: VIH = 3.0 V, IDUT = +1 mA, +40 mA; sink: VIL = 0.0 V, IDUT = -1 mA, -40 mA
DC ACCURACY						
VIH, VIL, VIT Offset Error	-500		+500	mV	P	VIH tests with VIL = -2.5 V, VIT = -2.5 V VIL tests with VIH = +7.5 V, VIT = +7.5 V VIT tests with VIL = -2.5 V, VIH = +7.5 V, unless otherwise specified Measured at DAC Code 0x4000 (0 V), uncalibrated
VIH, VIL, VIT Offset Tempco		±625		µV/°C	C _T	
VIH, VIL, VIT Gain	1.0		1.1	V/V	P	Gain derived from measurements at DAC Code 0x4000 (0 V) and DAC Code 0xC000 (5 V); based on ideal DAC transfer functions (see Table 21)
VIH, VIL, VIT Gain Tempco		±40		ppm/°C	C _T	
VIH, VIL, VIT DNL		±1		mV	C _T	After two point gain/offset calibration; calibration points at 0x4000 (0 V) output; 0xC000 (+5 V) output; measured over full specified output range
VIH, VIL, VIT INL	-7		+7	mV	P	After two point gain/offset calibration; applies to nominal VDD = +10.0 V supply case only

Parameter	Min	Typ	Max	Unit	Test Level	Conditions
VIH, VIL, VIT Resolution		153		μV	D	
DUTGND Voltage Accuracy	-7	±2	+7	mV	P	Over ±0.1 V range; measured at end points of VIH, VIL, and VIT functional range
DC Levels Interaction						DC interaction on VIL, VIH, and VIT output level while other driver DAC levels are varied
VIH vs. VIL		±0.2		mV	CT	Monitor interaction on VIH = +6.5 V; sweep VIL = -1.5 V to +6.4 V, VIT = +1.0 V
VIH vs. VIT		±1		mV	CT	Monitor interaction on VIH = +6.5 V; sweep VIT = -1.5 V to +6.5 V, VIL = 0.0 V
VIL vs. VIH		±0.2		mV	CT	Monitor interaction on VIL = -1.5 V; sweep VIH = -1.4 V to +6.5 V, VIT = +1.0 V
VIL vs. VIT		±1		mV	CT	Monitor interaction on VIL = -1.5 V; sweep VIT = -1.5 V to +6.5 V, VIH = +2.0 V
VIT vs. VIH		±1		mV	CT	Monitor interaction on VIT = +1.0 V; sweep VIH = -1.4 V to +6.5 V, VIL = -1.5 V
VIT vs. VIL		±1		mV	CT	Monitor interaction on VIT = +1.0 V; sweep VIL = -1.5 V to +6.4 V, VIH = +6.5 V
Overall Voltage Accuracy		±8		mV	CT	VIH - VIL ≥ 100 mV; sum of INL, dc interaction, DUTGND, and tempco errors over ±5°C, after calibration
VIH, VIL, VIT DC PSRR		±10		mV/V	CT	Measured at calibration points
AC SPECIFICATIONS						All ac specifications performed after calibration
Rise/Fall Times						Toggle DATx
0.2 V Programmed Swing, T _{RISE}		215		ps	CB	20% to 80%, VIH = 0.2 V, VIL = 0.0 V, terminated
0.2 V Programmed Swing, T _{FALL}		277		ps	CB	20% to 80%, VIH = 0.2 V, VIL = 0.0 V, terminated
0.5 V Programmed Swing, T _{RISE}		218		ps	CB	20% to 80%, VIH = 0.5 V, VIL = 0.0 V, terminated
0.5 V Programmed Swing, T _{FALL}		274		ps	CB	20% to 80%, VIH = 0.5 V, VIL = 0.0 V, terminated
1.0 V Programmed Swing, T _{RISE}	150	222	320	ps	P	20% to 80%, VIH = 1.0 V, VIL = 0.0 V, terminated
1.0 V Programmed Swing, T _{FALL}	150	283	320	ps	P	20% to 80%, VIH = 1.0 V, VIL = 0.0 V, terminated
2.0 V Programmed Swing, T _{RISE}		297		ps	CB	20% to 80%, VIH = 2.0 V, VIL = 0.0 V, terminated
2.0 V Programmed Swing, T _{FALL}		322		ps	CB	20% to 80%, VIH = 2.0 V, VIL = 0.0 V, terminated
3.0 V Programmed Swing, T _{RISE}		447		ps	CB	20% to 80%, VIH = 3.0 V, VIL = 0.0 V, terminated
3.0 V Programmed Swing, T _{FALL}		397		ps	CB	20% to 80%, VIH = 3.0 V, VIL = 0.0 V, terminated
5.0 V Programmed Swing, T _{RISE}		1117		ps	CB	10% to 90%, VIH = 5.0 V, VIL = 0.0 V, unterminated
5.0 V Programmed Swing, T _{FALL}		798		ps	CB	10% to 90%, VIH = 5.0 V, VIL = 0.0 V, unterminated
Rise to Fall Matching		-25		ps	CB	Rise to fall within one channel, VIH = 2.0 V, VIL = 0.0 V, terminated
		-61		ps	CB	Rise to fall within one channel; VIH = 1.0 V, VIL = 0.0 V, terminated
Minimum Pulse Width						Toggle DATx
0.5 V Programmed Swing		725		ps	CB	VIH = 0.5 V, VIL = 0.0 V, terminated, timing error less than +69/-33 ps
		725		ps	CB	VIH = 0.5 V, VIL = 0.0 V, terminated, less than 10% amplitude loss
Maximum Toggle Rate		2040		Mbps	CB	VIH = 0.5 V, VIL = 0.0 V, terminated, less than 10% loss at 50% duty
1.0 V Programmed Swing		725		ps	CB	VIH = 1.0 V, VIL = 0.0 V, terminated, timing error less than +58/-35 ps
		725		ps	CB	VIH = 1.0 V, VIL = 0.0 V, terminated, less than 10% amplitude loss

Parameter	Min	Typ	Max	Unit	Test Level	Conditions
Maximum Toggle Rate		2040		Mbps	C _B	VIH = 1.0 V, VIL = 0.0 V, terminated, less than 10% loss at 50% duty
2.0 V Programmed Swing		725		ps	C _B	VIH = 2.0 V, VIL = 0.0 V, terminated, timing error less than +80/-48 ps
		725		ps	C _B	VIH = 2.0 V, VIL = 0.0 V, terminated, less than 10% amplitude loss
Maximum Toggle Rate		1400		Mbps	C _B	VIH = 2.0 V, VIL = 0.0 V, terminated, less than 10% loss at 50% duty
3.0 V Programmed Swing		900		ps	C _B	VIH = 3.0 V, VIL = 0.0 V, terminated, timing error less than +50/-83 ps
		900		ps	C _B	VIH = 3.0 V, VIL = 0.0 V, terminated, less than 10% amplitude loss
Maximum Toggle Rate		1100		Mbps	C _B	VIH = 3.0 V, VIL = 0.0 V, terminated, less than 10% amplitude loss at 50% duty cycle
Dynamic Performance, Drive (VIH to VIL)						Toggle DATx
Propagation Delay Time		1.26		ns	C _B	VIH = 2.0 V, VIL = 0.0 V, terminated
Propagation Delay Tempco		1.4		ps/°C	C _B	VIH = 2.0 V, VIL = 0.0 V, terminated
Delay Matching, Edge to Edge		43		ps	C _B	VIH = 2.0 V, VIL = 0.0 V, terminated, rising vs. falling
Delay Matching, Channel to Channel		32		ps	C _B	VIH = 2.0 V, VIL = 0.0 V, terminated, rising vs. rising, falling vs. falling
Delay Change vs. Duty Cycle		-28		ps	C _B	VIH = 2.0 V, VIL = 0.0 V, terminated, 5% to 95% duty cycle
Overshoot and Undershoot		-116		mV	C _B	VIH = 2.0 V, VIL = 0.0 V, terminated, driver CLC set to 0
Settling Time (VIH to VIL)						Toggle DATx
To Within 3% of Final Value		1.7		ns	C _B	VIH = 2.0 V, VIL = 0.0 V, terminated
To Within 1% of Final Value		45		ns	C _B	VIH = 2.0 V, VIL = 0.0 V, terminated
Dynamic Performance, VTerm (VIH or VIL to/from VIT)						Toggle RCVx
Propagation Delay Time		1.39		ns	C _B	VIH = 2.0 V, VIT = 1.0 V, VIL = 0.0 V, terminated
Propagation Delay Tempco		2.3		ps/°C	C _B	VIH = 2.0 V, VIT = 1.0 V, VIL = 0.0 V, terminated
Transition Time, Active to VIT		310		ps	C _B	20% to 80%, VIH = 2.0 V, VIT = 1.0 V, VIL = 0.0 V, terminated
Transition Time, VIT to Active		329		ps	C _B	20% to 80%, VIH = 2.0 V, VIT = 1.0 V, VIL = 0.0 V, terminated
Dynamic Performance, Inhibit (VIH or VIL to/from Inhibit)						Toggle RCVx
Transition Time, Inhibit to Active		357		ps	C _B	20% to 80%, VIH = +1.0 V, VIL = -1.0 V, terminated
Transition Time, Active to Inhibit		1.34		ns	C _B	20% to 80%, VIH = +1.0 V, VIL = -1.0 V, terminated
Prop Delay, Inhibit to VIH		2.6		ns	C _B	VIH = +1.0 V, VIL = -1.0 V, terminated; measured from RCVx input crossing to DUTx pin output 50%
Prop Delay, Inhibit to VIL		2.8		ns	C _B	VIH = +1.0 V, VIL = -1.0 V, terminated
Prop Delay Matching, Inhibit to VIL vs. Inhibit to VIH		52		ps	C _B	VIH = +1.0 V, VIL = -1.0 V, terminated
Prop Delay, VIH to Inhibit		2.29		ns	C _B	VIH = +1.0 V, VIL = -1.0 V, terminated, measured from RCVx input crossing to DUTx pin output 50%
Prop Delay, VIL to Inhibit		2.02		ns	C _B	VIH = +1.0 V, VIL = -1.0 V, terminated
I/O Spike		24		mV pk-pk	C _B	VIH = 0.0 V, VIL = 0.0 V, terminated
Driver Pre-Emphasis (CLC)						
Pre-Emphasis Amplitude Rising		35		%	C _B	VIH = 2.0 V, VIL = 0.0 V, terminated, DRV_CLC_x[15:13] = 7
		14		%	C _B	VIH = 2.0 V, VIL = 0.0 V, terminated, DRV_CLC_x[15:13] = 0
Pre-Emphasis Amplitude Falling		24		%	C _B	VIH = 2.0 V, VIL = 0.0 V, terminated, DRV_CLC_x[15:13] = 7
		16		%	C _B	VIH = 2.0 V, VIL = 0.0 V, terminated, DRV_CLC_x[15:13] = 0

Parameter	Min	Typ	Max	Unit	Test Level	Conditions
Pre-Emphasis Resolution		2		%	D	
Pre-Emphasis Time Constant		0.8		ns	C _B	VIH = 2.0 V, VIL = 0.0 V, terminated

Table 3. Reflection Clamp (Clamp Accuracy Specifications Apply Only When VCH – VCL > 0.8 V)

Parameter	Min	Typ	Max	Unit	Test Level	Conditions
VCH/VCL PROGRAMMABLE RANGE	-2.5		+7.5	V	D	DC specifications apply over full functional range unless noted.
VCH						
VCH Functional Range	-1.2		+7.0	V	D	
VCH Offset Error	-300		+300	mV	P	Driver high-Z, sinking 1 mA, measured at DAC Code 0x4000, uncalibrated.
VCH Offset Tempco		±0.5		mV/°C	C _T	
VCH Gain	1.0		1.1	V/V	P	Driver high-Z, sinking 1 mA, gain derived from measurements at DAC Code 0x4000 (0 V) and DAC Code 0xC000 (5 V), based on ideal DAC transfer function (see Table 21).
VCH Gain Tempco		±30		ppm/°C	C _T	
VCH Resolution		153		μV	D	
VCH DNL		±1		mV	C _T	Driver high-Z, sinking 1 mA, after two point gain/offset calibration; calibration points at DAC Code 0x4000 (0 V) and DAC Code 0xC000 (5 V), measured over functional clamp range.
VCH INL	-20		+20	mV	P	Driver high-Z, sinking 1 mA, after two point gain/offset calibration; calibration points at 0x4000 (0 V) and 0xC000 (5 V), measured over functional clamp range.
VCL						
VCL Functional Range	-2		+6.2	V	D	
VCL Offset Error	-300		+300	mV	P	Driver high-Z, sourcing 1 mA, measured at DAC Code 0x4000, uncalibrated.
VCL Offset Tempco		±0.5		mV/°C	C _T	
VCL Gain	1.0		1.1	V/V	P	Drive high-Z, sourcing 1 mA, gain derived from measurements at DAC Code 0x4000 (0 V) and DAC Code 0xC000 (5 V), based on ideal DAC transfer function (see Table 21).
VCL Gain Tempco		±30		ppm/°C	C _T	
VCL Resolution		153		μV	D	
VCL DNL		±1		mV	C _T	Driver high-Z, sourcing 1 mA, after two point gain/offset calibration; calibration points at 0x4000 (0 V) and 0xC000 (+5 V), measured over functional clamp range.
VCL INL	-20		+20	mV	P	Driver high-Z, sourcing 1 mA, after two point gain/offset calibration; calibration points at 0x4000 (0 V) and 0xC000 (+5 V), measured over functional clamp range.
DC Clamp Current Limit, VCH	-120		-75	mA	P	Driver high-Z, VCH = 0 V, VCL = -2.0 V, VDUTx = +5.0 V.
DC Clamp Current Limit, VCL	+75		+120	mA	P	Driver high-Z, VCH = +6.0 V, VCL = +5.0 V, VDUTx = 0.0 V.
DUTGND Voltage Accuracy	-7	±2	+7	mV	P	Over ±0.1 V range, measured at end points of VCH and VCL functional range.

Table 4. Normal Window Comparator (NWC) (Unless Otherwise Specified: VOH Tests at VOL = -1.5 V, VOL Tests at VOH = +6.5 V, Specifications Apply to Both Comparators)

Parameter	Min	Typ	Max	Unit	Test Level	Conditions
DC SPECIFICATIONS						
Input Voltage Range	-1.5		+6.5	V	D	
Differential Voltage Range	±0.1		±8.0	V	D	
Comparator Input Offset Voltage	-250		+250	mV	P	Measured at DAC Code 0x4000 (0V), uncalibrated
Input Offset Voltage Tempco		±100		µV/°C	C _T	
Gain	1.0		1.1	V/V	P	Gain derived from measurements at DAC Code 0x4000 (0 V) and DAC Code 0xC000 (5 V); based on ideal DAC transfer function (see Table 21)
Gain Tempco		±25		ppm/°C	C _T	
Threshold Resolution		153		µV	D	
Threshold DNL		±1		mV	C _T	Measured over -1.5 V to +6.5 V functional range after two point gain/offset calibration; calibration points at 0x4000 (0 V) and 0xC000 (5 V)
Threshold INL	-7		+7	mV	P	Measured over -1.5 V to +6.5 V functional range after two point gain/offset calibration; calibration points at 0x4000 (0 V) and 0xC000 (5 V)
DUTGND Voltage Accuracy	-7	±2	+7	mV	P	Over ±0.1 V range; measured at end points of VOH and VOL functional range
Uncertainty Band		5		mV	C _B	VDUTx = 0 V, sweep comparator threshold to determine the uncertainty band
Maximum Programmable Hysteresis		96		mV	C _B	
Hysteresis Resolution		5		mV	D	Calculated over hysteresis control Code 10 to Code 31
DC PSRR		±5		mV/V	C _T	Measured at calibration points
Digital Output Characteristics						
Internal Pull-Up Resistance to Comparator, VTTC	46	50	54	Ω	P	Pull 1 mA and 10 mA from Logic 1 leg and measure ΔV to calculate resistance; measured ΔV/9 mA; done for both comparator logic states
Comparator Termination Voltage, VTTC	0.5	1.2	3.3	V	D	
Common Mode Voltage		VTTC - 0.3		V	C _T	Measured with 100 Ω differential termination
	VTTC - 0.5		VTTC	V	P	Measured with no external termination
Differential Voltage		250		mV	C _T	Measured with 100 Ω differential termination
	450	500	550	mV	P	Measured with no external termination
Rise/Fall Times, 20% to 80%		166		ps	C _B	Measured with 50 Ω to external termination voltage (VTTC)
AC SPECIFICATIONS						
Propagation Delay, Input to Output		0.93		ns	C _B	All ac specifications performed after dc level calibration, input transition time of ~200 ps, 20% to 80%, measured with 50 Ω to external termination voltage (VTTC); peaking set to CLC = 2, unless otherwise specified VDUTx: 0 V to 1.0 V swing, driver term mode, VIT = 0.0 V, comparator threshold = 0.5 V
Propagation Delay Tempco		1.6		ps/°C	C _B	VDUTx: 0 V to 1.0 V swing, driver term mode, VIT = 0.0 V, comparator threshold = 0.5 V
Propagation Delay Matching High Transition to Low Transition		7		ps	C _B	VDUTx: 0 V to 1.0 V swing, driver term mode, VIT = 0.0 V, comparator threshold = 0.5 V
Propagation Delay Matching High to Low Comparator		7		ps	C _B	VDUTx: 0 V to 1.0 V swing, driver term mode, VIT = 0.0 V, comparator threshold = 0.5 V

Parameter	Min	Typ	Max	Unit	Test Level	Conditions
Propagation Delay Dispersion						
Slew Rate 400 ps vs. 1 ns (20% to 80%)		19		ps	C _B	VDUTx: 0 V to 0.5 V swing, driver term mode, VIT = 0.0 V, comparator threshold = 0.25 V
Overdrive 250 mV vs. 1.0 V		40		ps	C _B	For 250 mV, VDUTx: 0 V to 0.5 V swing; for 1.0 V, VDUTx: 0 V to 1.25 V swing, driver term mode, VIT = 0.0 V, comparator threshold = 0.25 V
1 V Pulse Width 0.7 ns, 1 ns, 5 ns, 10 ns		+2/- 17		ps	C _B	VDUTx: 0 V to 1.0 V swing at ~32.0 MHz; driver term mode, VIT = 0.0 V, comparator threshold = 0.5 V
0.5 V Pulse Width 0.6 ns, 1 ns, 5 ns, 10 ns		+3/- 24		ps	C _B	VDUTx: 0 V to 0.5 V swing at ~32.0 MHz, driver term mode, VIT = 0.0 V; comparator threshold = 0.25 V
Duty Cycle 5% to 95%		21		ps	C _B	VDUTx: 0 V to 1.0 V swing at ~32.0 MHz; driver term mode, VIT = 0.0 V, comparator threshold = 0.5 V
Minimum Detectable Pulse Width		0.5		ns	C _B	VDUTx: 0 V to 1.0 V swing at 32.0 MHz, driver term mode, VIT = 0.0 V; greater than 50% output differential amplitude
Input Equivalent Bandwidth, Terminated		1520		MHz	C _B	VDUTx: 0 V to 1.0 V swing; driver term mode, VIT = 0.0 V, CLC = 2; as measured by shmoo plot; $f_{EQUIV} = 0.22/\sqrt{(t_{MEAS}^2 - t_{DUT}^2)}$
ERT High-Z Mode, 3 V, 20% to 80%		721		ps	C _B	VDUTx: 0 V to 3.0 V swing, driver high-Z as measured by shmoo plot; $f_{EQUIV} = 0.22/\sqrt{(t_{MEAS}^2 - t_{DUT}^2)}$
Comparator Pre-Emphasis (CLC) CLC Amplitude Range		16		%	C _B	VDUTx: 0 V to 1.0 V swing, driver term mode, VIT = 0.0 V, comparator pre-emphasis set to maximum
CLC Resolution		2.3		% per bit	C _B	3-bit amplitude control
Pre-Emphasis Time Constant		4.3		ns	C _B	VDUTx: 0 V to 1.0 V swing, driver term mode, VIT = 0.0 V, comparator pre-emphasis set to maximum

Table 5. Differential Mode Comparator (DMC) (Unless Otherwise Specified: VOH Tests at VOL = -1.1 V, VOL Tests at VOH = +1.1 V)

Parameter	Min	Typ	Max	Unit	Test Level	Conditions
DC SPECIFICATIONS						
Input Voltage Range	-1.5		+6.5	V	D	
Functional Differential Range	±0.05		±1.1	V	D	
Maximum Differential Input			±8	V	D	
Input Offset Voltage	-250		+250	mV	P	Offset extrapolated from measurements at DAC Code 0x2666 (-1 V) and DAC Code 0x599A (+1 V), with V _{CM} = 0 V
Offset Voltage Tempco		±150		µV/°C	C _T	
Gain	1.0		1.1	V/V	P	Gain derived from measurements at DAC Code 0x2666 (-1 V) and DAC Code 0x599A (+1 V), based on ideal DAC transfer function (see Table 21)
Gain Tempco		±25		ppm/°C	C _T	
VOH, VOL Resolution		153		µV	D	
VOH, VOL DNL		±1		mV	C _T	After two point gain/offset calibration, V _{CM} = 0.0 V, calibration points at 0x2666 (-1 V) and 0x599A (+1 V)
VOH, VOL INL	-7		+7	mV	P	After two point gain/offset calibration, measured over VOH/VOL range of -1.1 V to +1.1 V, V _{CM} = 0.0 V; calibration points at 0x2666 (-1 V) and 0x599A (+1 V)
Uncertainty Band		7		mV	C _B	VDUTx = 0 V; sweep comparator threshold to determine the uncertainty band

Parameter	Min	Typ	Max	Unit	Test Level	Conditions
Maximum Programmable Hysteresis		117		mV	C _B	
Hysteresis Resolution		5.6		mV	D	Calculated over hysteresis control Code 10 to Code 31
CMRR	-1		+1	mV/V	P	Offset measured at V _{CM} = -1.5 V and +6.5 V with V _{DM} = 0.0 V, offset error change
DC PSRR		±5		mV/V	C _T	Measured at calibration points
AC SPECIFICATIONS						All ac specifications performed after dc level calibration, unless noted; input transition time ~200 ps, 20% to 80%, measured with 50 Ω to external termination voltage (VTTC), peaking set to CLC = 2, unless otherwise specified
Propagation Delay, Input to Output		0.83		ns	C _B	VDUT0 = 0 V, VDUT1: -0.5 V to +0.5 V swing, driver term mode, VIT = 0.0 V, comparator threshold = 0.0 V, repeat for other channel
Propagation Delay Tempco		2.6		ps/°C	C _B	VDUT0 = 0 V, VDUT1: -0.5 V to +0.5 V swing, driver term mode, VIT = 0.0 V, comparator threshold = 0.0 V, repeat for other channel
Propagation Delay Matching, High Transition to Low Transition		15		ps	C _B	VDUT0 = 0 V, VDUT1: -0.5 V to +0.5 V swing, driver term mode, VIT = 0.0 V, comparator threshold = 0.0 V, repeat for other channel
Propagation Delay Matching, High to Low Comparator		17		ps	C _B	VDUT0 = 0 V, VDUT1: -0.5 V to +0.5 V swing, driver term mode, VIT = 0.0 V, comparator threshold = 0.0 V, repeat for other channel
Propagation Delay Change (Dispersion) With Respect To						
Slew Rate: 400 ps and 1 ns (20% to 80%)		31		ps	C _B	VDUT0 = 0.0 V; VDUT1: -0.5 V to +0.5 V swing; driver term mode, VIT = 0.0 V; comparator threshold = 0.0 V, repeat for other channel
Overdrive: 250 mV and 750 mV		32		ps	C _B	VDUT0 = 0.0 V; for 250 mV: VDUT1: 0 V to 0.5 V swing; for 750 mV: VDUT1: 0 V to 1.0 V swing; driver term mode, VIT = 0.0 V; comparator threshold = -0.25 V; repeat for other channel with comparator threshold = +0.25 V
1 V Pulse Width: 0.7 ns, 1 ns, 5 ns, 10 ns		+1/- 21		ps	C _B	VDUT0 = 0.0 V; VDUT1: -0.5 V to +0.5 V swing at 32 MHz; driver term mode, VIT = 0.0 V; comparator threshold = 0.0 V; repeat for other channel
0.5 V Pulse Width: 0.6 ns, 1 ns, 5 ns, 10 ns		+1/- 31		ps	C _B	VDUT0 = 0.0 V; VDUT1: -0.25 V to +0.25 V swing at 32 MHz; driver term mode, VIT = 0.0 V; comparator threshold = 0.0 V; repeat for other channel
Duty Cycle: 5% to 95%		18		ps	C _B	VDUT0 = 0.0 V; VDUT1: -0.5 V to +0.5 V swing at 32 MHz; driver term mode, VIT = 0.0 V; comparator threshold = 0.0 V; repeat for other channel
Minimum Detectable Pulse Width		0.5		ns	C _B	VDUT0 = 0.0 V; VDUT1: -0.5 V to +0.5 V swing at 32 MHz; driver term mode, VIT = 0.0 V; comparator threshold = 0.0 V; greater than 50% output differential amplitude; repeat for other channel
Input Equivalent Bandwidth, Terminated		1038		MHz	C _B	VDUT0 = 0.0 V; VDUT1: -0.5 V to +0.5 V swing; driver term mode, VIT = 0.0 V; comparator threshold = 0.0 V, CLC = 2 as measured by shmoo; repeat for other channel
Comparator Pre-Emphasis (CLC) CLC Amplitude Range		11		%	C _B	VDUT0 = 0.0 V; VDUT1: -0.8 V to +0.8 V swing, driver term mode, VIT = 0.0 V; comparator threshold = 0.0 V; comparator CLC set to maximum; repeat for other channel
CLC Resolution		1.6		% per bit	C _B	3-bit amplitude control
Pre-Emphasis Time Constant		4.8		ns	C _B	VDUT0 = 0.0 V; VDUT1: -0.8 V to +0.8 V swing, driver term mode, VIT = 0.0 V; comparator threshold = 0.0 V; comparator CLC set to maximum; repeat for other channel

Table 6. Active Load

Parameter	Min	Typ	Max	Unit	Test Level	Conditions
DC SPECIFICATIONS						
Load active on, RCVx active, unless otherwise noted						
Input Characteristics						
VCOM Voltage Range	-1.5		+6.5	V	D	IOL and IOH ≤ 1 mA
	-1.0		+5.5	V	D	IOL and IOH ≤ 25 mA
VCOM Offset	-200		+200	mV	P	Measured at DAC Code 0x4000, uncalibrated
VCOM Offset Tempco		±25		μV/°C	C _T	
VCOM Gain	1.0		1.1	V/V	P	Gain derived from measurements at DAC Code 0x4000 (0 V) and DAC Code 0xC000 (+5 V), based on ideal DAC transfer function (see Table 21)
VCOM Gain Tempco		±25		ppm/°C	C _T	
VCOM Resolution		153		μV	D	
VCOM DNL		±1		mV	C _T	IOH = IOL = 12.5 mA; after two point gain/offset calibration; measured over VCOM range of -1.5 V to +6.5 V; calibration points at 0x4000 (0 V) and 0xC000 (+5 V)
VCOM INL	-7		+7	mV	P	IOH = IOL = 12.5 mA; after two point gain/offset calibration; measured at end points of VCOM functional range
DUTGND Voltage Accuracy	-7	±2	+7	mV	P	Over ±0.1 V range
Output Characteristics						
Maximum Source Current	25			mA	D	-1.5 V to +5.5 V DUT range
IOL Offset	-600		+600	μA	P	IOH = -2.5 mA, VCOM = 1.5 V, VDUTx = 0.0 V; offset extrapolated from measurements at DAC Code 0x451F (1 mA) and DAC Code 0xA666 (20 mA)
IOL Offset Tempco		±1		μA/°C	C _T	
IOL Gain Error	0		25	%	P	IOH = -2.5 mA, VCOM = 1.5 V, VDUTx = 0.0 V; gain derived from measurements at DAC Code 0x451F (1 mA) and DAC Code 0xA666 (20 mA); based on ideal DAC transfer function (see Table 21 and Table 22)
IOL Gain Tempco		±25		ppm/°C	C _T	
IOL Resolution		763		nA	D	
IOL DNL		±4		μA	C _T	IOH = -2.5 mA, VCOM = 1.5 V, VDUTx = 0.0 V; after two point gain/offset calibration; measured over IOL range, 0 mA to 25 mA; calibrated at Code 0x451F (1 mA) and Code 0xA666 (20 mA)
IOL INL	-100	±20	+100	μA	P	IOH = -2.5 mA, VCOM = 1.5 V, VDUTx = 0.0 V; after two point gain/offset calibration
IOL 90% Commutation Voltage		0.25	0.4	V	P	IOH = IOL = 25 mA, VCOM = 2.0 V; measure IOL reference at VDUTx = -1.0 V; measure IOL current at VDUTx = 1.6 V; check >90% of reference current
IOL 90% Commutation Voltage		0.1		V	C _T	IOH = IOL = 1 mA, VCOM = 2.0 V; measure IOL reference at VDUTx = -1.0 V; measure IOL current at VDUTx = 1.9 V; check >90% of reference current
Maximum Sink Current	25			mA	D	-1.0 V to +6.5 V output range
IOH Offset	-600		+600	μA	P	IOL = -2.5 mA, VCOM = 1.5 V, VDUTx = 3.0 V; offset extrapolated from measurements at DAC Code 0x451F (1 mA) and DAC Code 0xA666 (20 mA)
IOH Offset Tempco		±1		μA/°C	C _T	
IOH Gain Error	0		25	%	P	IOL = -2.5 mA, VCOM = 1.5 V, VDUTx = 3.0 V; gain derived from measurements at DAC Code 0x451F (1 mA) and DAC Code 0xA666 (20 mA); based on ideal DAC transfer function (see Table 21 and Table 22)

Parameter	Min	Typ	Max	Unit	Test Level	Conditions
IOH Gain Tempco		±25		ppm/°C	C _T	
IOH Resolution		763		nA	D	
IOH DNL		±4		μA	C _T	IOL = -2.5 mA, VCOM = 1.5 V, VDUTx = 3.0 V; after two point gain/offset calibration; measured over IOH range, 0 mA to 25 mA; calibrated at Code 0x451F (1 mA) and Code 0xA666 (20 mA)
IOH INL	-100	±25	+100	μA	P	IOL = -2.5 mA, VCOM = 1.5 V, VDUTx = 3.0 V; after two point gain/offset calibration
IOH 90% Commutation Voltage		0.25	0.4	V	P	IOH = IOL = 25 mA, VCOM = 2.0 V; measure IOH reference at VDUTx = 5.0 V; measure IOH current at VDUTx = 2.4 V; ensure >90% of reference current
		0.1		V	C _T	IOH = IOL = 1 mA, VCOM = 2.0 V; measure IOH reference at VDUTx = 5.0 V; measure IOH current at VDUTx = 2.1 V; ensure >90% of reference current
AC SPECIFICATIONS						All ac specifications performed after dc level calibration unless noted; load active on
Dynamic Performance						
Propagation Delay, Load Active On to Load Active Off; 50%, 90%		3.1		ns	C _B	Toggle RCVx; DUTx terminated 50 Ω to GND; IOL = IOH = 20 mA, VIH = VIL = 0 V; VCOM = +1.5 V for IOL and -1.5 V for IOH; measured from 50% point of RCVx - RCVx to 90% point of final output; repeat for drive low and drive high
Propagation Delay, Load Active Off to Load Active On; 50%, 90%		4.1		ns	C _B	Toggle RCVx; DUTx terminated 50 Ω to GND; IOL = IOH = 20 mA, VIH = VIL = 0 V; VCOM = +1.5 V for IOL and -1.5 V for IOH; measured from 50% point of RCVx - RCVx to 90% point of final output; repeat for drive low and drive high
Propagation Delay Matching		1.0		ns	C _B	Toggle RCVx; DUTx terminated 50 Ω to GND; IOL = IOH = 20 mA, VIH = VIL = 0 V; VCOM = +1.5 V for IOL and -1.5 V for IOH; active on vs. active off; repeat for drive low and drive high
Load Spike		106		mV pk-pk	C _B	Toggle RCVx; DUTx terminated 50 Ω to GND; IOL = IOH = 0 mA, VIH = VIL = 0 V; VCOM = +1.5 V for IOL and -1.5 V for IOH; repeat for drive low and drive high
Settling Time to 90%		1.6		ns	C _B	Toggle RCVx; DUTx terminated 50 Ω to GND; IOL = IOH = 20 mA, VIH = VIL = 0 V; VCOM = +1.5 V for IOL and -1.5 V for IOH; measured at 90% of final value

Table 7. PPMU (PPMU Enabled in FV, DCL Disabled)

Parameter	Min	Typ	Max	Unit	Test Level	Conditions
FORCE VOLTAGE						
Current Range A	-40		+40	mA	D	
Current Range B	-1		+1	mA	D	
Current Range C	-100		+100	μA	D	
Current Range D	-10		+10	μA	D	
Current Range E	-2		+2	μA	D	
Voltage Range at Output						
Range A	-2.0		+5.75	V	D	Output range for full-scale source and sink.
	-2.0		+6	V	D	Output range for ±25 mA.
Range B, Range C, Range D, and Range E	-2.0		+6.5	V	D	Output range for full-scale source and sink.
Offset						
Range C	-100		+100	mV	P	Measured at DAC Code 0x4000 (0 V).
All Ranges		±10		mV	C _T	Measured at DAC Code 0x4000 (0 V).
Offset Tempco, All Ranges		±25		μV/°C	C _T	

Parameter	Min	Typ	Max	Unit	Test Level	Conditions
Gain						
Range C	1.0		1.1	V/V	P	Gain derived from measurements at DAC Code 0x4000 (0 V) and DAC Code 0xC000 (5 V); based on ideal DAC transfer function (see Table 21 and Table 23).
All Ranges		1.05		V/V	C _T	Gain derived from measurements at DAC Code 0x4000 (0 V) and DAC Code 0xC000 (5 V); based on ideal DAC transfer function (see Table 21 and Table 23).
Gain Tempco, All Ranges		±25		ppm/°C	C _T	Gain derived from measurements at DAC Code 0x4000 (0V) and DAC Code 0xC000 (5 V); calibration point 0x4000 (0 V) and 0xC000 (+5 V) output.
INL						
Range A		±1		mV	CT	After two point gain/offset calibration, output range of –2.0 V to +5.75 V, PPMU Current Range A only.
Range C	–1.7		+1.7	mV	P	After two point gain/offset calibration; output range of –2.0 V to +6.5 V.
Range B, Range D, and Range E		±1		mV	C _T	After two point gain/offset calibration, output range of –2.0 V to +6.5 V.
Compliance vs. Current Load						
Range A		±40		mV	C _T	Force –2.0 V; measure voltage while sinking zero and full-scale current; measure ΔV; force +5.75 V; measure voltage while sourcing zero and full-scale current; measure ΔV.
		±25		mV	C _T	Force –2.0 V; measure voltage while sinking zero and 25 mA current; measure ΔV; force +6 V; measure voltage while sourcing zero and 25 mA current; measure ΔV.
Range B, Range C, Range D, and Range E		±1		mV	C _T	Force –2.0 V; measure voltage while sinking zero and full-scale current; measure ΔV; force +6.5 V; measure voltage while sourcing zero and full-scale current; measure ΔV.
Current Limit, Source and Sink All Ranges	120	140	180	%FS	P	Sink: force –2.0 V, short DUTx to +6.5 V; source: force +6.5 V, short DUTx to –2.0 V; repeat for each current range; example: Range A FS = 40 mA, 120% FS = 48 mA 180% FS = 72 mA
DUTGND Voltage Accuracy	–7	±2	+7	mV	P	Over ±0.1 V range; measured at endpoints of PPMU_VIN _{FV} functional range (see Figure 136).
MEASURE CURRENT						PPMU enabled in FIMI, DCL disabled.
DUTx Pin Voltage Range at Full Current						
Range A	–2.0		+5.75	V	D	
Range B, Range C, Range D, and Range E	–2.0		+6.5	V	D	
Zero-Current Offset, Range B	–2		+2	%FSR	P	Interpolated from measurements sourcing and sinking 80% FSR current each range; FSR = 80 mA for Range A, 2 mA for Range B, 200 μA for Range C, 20 μA for Range D, 4 μA for Range E (see Table 21 and Table 23).
All Ranges		±0.5		%FSR	C _T	See Table 21 and Table 23.
Zero-Current Offset Tempco, Range A		±0.001		%FSR/°C	C _T	See Table 21 and Table 23.

Parameter	Min	Typ	Max	Unit	Test Level	Conditions
Range B, Range C, and Range D		±0.001		%FSR/°C	C _T	
Range E		±0.002		%FSR/°C	C _T	
Gain Error						
Range B	-30		+5	%	P	Based on measurements sourcing and sinking, 80% FSR current.
All Ranges		-10		%	C _T	Based on measurements sourcing and sinking, 80% FSR current.
Gain Tempco						
Range A		±50		ppm/°C	C _T	
Range B, Range C, Range D, and Range E		±25		ppm/°C	C _T	
INL						
Range A		±0.0125		%FSR	C _T	Range A, after two point gain/offset calibration at ±80% FSR current; measured over FSR output of -40 mA to +40 mA.
Range B	-0.03		+0.03	%FSR	P	After two point gain/offset calibration at ±80% FSR current; measured over FSR output of -1 mA to +1 mA.
Range C, Range D, and Range E		±0.01		%FSR	C _T	After two point gain/offset calibration at ±80% FSR current; measured over each FSR output for Range C, Range D, and Range E.
DUTx Pin Voltage Rejection	-1.2		+1.2	µA	P	Range B, FVMI, force -1 V and 5 V into load of 0.5 mA, measure ΔI reported at PPMU_MEASx pin.
DUTGND Voltage Accuracy	-7	±2	+7	mV	P	Over ±0.1 V range (see Figure 136).
FORCE CURRENT						PPMU enabled in FIMI, DCL disabled.
DUTx Pin Voltage Range in Range A	-2.0		+5.75	V	D	At full-scale source and sink current.
	-2.0		+6	V	D	At 25 mA source and sink current.
DUTx Pin Voltage Range at Full Current, Range B, Range C, Range D, and Range E	-2.0		+6.5	V	D	
Zero-Current Offset, All Ranges	-14.5		+14.5	%FSR	P	Extrapolated from measurements at Code 0x4CCC and Code 0xB333 for each range (see Table 21 and Table 23).
Zero-Current Offset Tempco		±0.002		%FSR/°C	C _T	
Gain Error, All Ranges	-5		+25	%	P	Derived from measurements at Code 0x4CCC and Code 0xB333 for each range (see Table 21 and Table 23).
Gain Tempco						
Range A		±50		ppm/°C	C _T	Significant PPMU self-heating effects in Range A can influence gain drift/tempco measurements.
Range B, Range C, Range D, and Range E		±25		ppm/°C	C _T	
INL						
Range A	-0.12	±0.02	+0.12	%FSR	P	After two point gain/offset calibration; measured over FSR output of -40 mA to +40 mA.
Range B, Range C, and Range D	-0.03		+0.03	%FSR	P	After two point gain/offset calibration; measured over FSR output; repeat for Range B, Range C, and Range D.

Parameter	Min	Typ	Max	Unit	Test Level	Conditions
Range E	-0.045		+0.045	%FSR	P	After two point gain/offset calibration; measured over FSR output.
Force Current Compliance vs. Voltage Load						
Range A	-0.3		+0.3	%FSR	P	Force positive full-scale current driving -2.0 V and +5.75 V; measure ΔI at DUTx pin; force negative full-scale current driving -2.0 V and +5.75 V; measure ΔI at DUTx pin.
	-0.3		+0.3	%FSR	P	Force +25 mA driving -2.0 V and +6.0 V; measure ΔI at DUTx pin; force -25 mA driving -2.0 V and +6.0 V; measure ΔI at DUTx pin.
	-0.06		+0.06	%FSR	P	Force positive full-scale current driving 0.0 V and +4.0 V; measure ΔI at DUTx pin; force negative full-scale current driving 0.0 V and +4.0 V; measure ΔI at DUTx pin.
Range B and Range C	-0.3		+0.3	%FSR	P	Force positive full-scale current driving -2.0 V and +6.5 V; measure ΔI at DUTx pin; force negative full-scale current driving -2.0 V and +6.5 V; measure ΔI at DUTx pin.
	-0.06		+0.06	%FSR	P	Force positive full-scale current driving 0.0 V and +4.0 V; measure ΔI at DUTx pin; force negative full-scale current driving 0.0 V and +4.0 V; measure ΔI at DUTx pin.
Range D	-0.3		+0.3	%FSR	P	Force positive full-scale current driving -2.0 V and +6.5 V; measure ΔI at DUTx pin; force negative full-scale current driving -2.0 V and +6.5 V; measure ΔI at DUTx pin; allows for 10 nA of DUTx pin leakage.
Range E	-0.85		+0.85	%FSR	P	Force positive full-scale current driving -2.0 V and +6.5 V; measure ΔI at DUTx pin; force negative full-scale current driving -2.0 V and +6.5 V; measure ΔI at DUTx pin; allows for 10 nA of DUTx pin leakage.
MEASURE VOLTAGE						PPMU enabled, FVMV, DCL disabled.
Voltage Range	-2.0		+6.5	V	D	
Offset	-25		+25	mV	P	Range B, VDUTx = 0 V; offset = (PPMU_MEAS - VDUTx).
Offset Tempco		±10		μV/°C	C _T	
Gain	0.98		1.02	V/V	P	Range B, gain derived from measurements at VDUTx = 0.0 V and +5.0 V.
Gain Tempco		±1		ppm/°C	C _T	
INL	-1.7		+1.7	mV	P	Range B, measured over -2.0 V to +6.5 V.
Measure Pin DC Characteristics						
Output Range	-2.0		+6.5	V	D	
DC Output Current			4	mA	D	
Output Impedance			200	Ω	P	PPMU enabled in FVMV, DCL disabled; Source resistance: PPMU force +6.5 V with 0 mA, +4 mA load Sink resistance: PPMU force -2.0 V with 0 mA, -4 mA load Resistance = $\Delta V/\Delta I$ at PPMU_MEAS pin.
Output Leakage Current When Tristated	-1		+1	μA	P	Tested at -2.0 V and +6.5 V.

Parameter	Min	Typ	Max	Unit	Test Level	Conditions
Output Short-Circuit Current	-25		+25	mA	P	PPMU enabled in FVMV, DCL disabled; Source: PPMU force +6.5 V, PPMU_MEAS to -2.0 V Sink: PPMU force -2.0 V, PPMU_MEAS to +6.5 V
PPMU_MEASx Pin, Output Capacitance		2		pF	S	
PPMU_MEASx Pin, Load Capacitance		100		pF	S	Maximum load capacitance.
VOLTAGE CLAMPS						
Low Clamp Range (VCL)	-2.0		+4.0	V	D	PPMU enabled in FIMI, DCL disabled, PPMU clamps enabled; clamp accuracy specifications apply only when VCH > VCL.
High Clamp Range (VCH)	0.0		+6.5	V	D	
Positive Clamp Voltage Droop	-300	±1	+300	mV	P	ΔV seen at DUTx pin, Range A, VCH = +5.0 V, VCL = -1 V; PPMU force 5 mA and 40 mA into open.
Negative Clamp Voltage Droop	-300	±1	+300	mV	P	ΔV seen at DUTx pin, Range A, VCH = +5.0 V, VCL = -1 V, PPMU force -5 mA and 40 mA into open.
Offset, PPMU Clamp VCH/VCL	-300		+300	mV	P	Range B, PPMU force ±0.5 mA into open; VCH measured at DAC Code 0x4000 (0 V) with VCL at Code 0x0000 (-2.5 V); VCL measured at DAC Code 0x4000 (0 V) with VCH at 0xFFFF (+7.5 V).
Offset Tempco, PPMU Clamp VCH/VCL		±0.5		mV/°C	C _T	
Gain, PPMU Clamp VCH/VCL	1.0		1.2	V/V	P	Range B, PPMU force ±0.5 mA into open; VCH gain derived from measurements at DAC Code 0x4000 (0 V) and DAC Code 0xC000 (+5.0 V) with VCL at Code 0x0000 (-2.5 V); VCL gain derived from measurements at DAC Code 0x4000 (0 V) and DAC Code 0xA666 (+4.0 V) with VCH at 0xFFFF (+7.5 V).
Gain Tempco, PPMU Clamp VCH/VCL		±25		ppm/°C	C _T	
INL, PPMU Clamp VCH/VCL	-20		+20	mV	P	Range B, PPMU force ±0.5 mA into open, after two point gain/offset calibration; measured over PPMU clamp functional range.
DUTGND Voltage Accuracy	-7	±2	+7	mV	P	Over ±0.1 V range; measured at end points of clamp functional range.
SETTLING/SWITCHING TIMES						
Force Voltage Settling Time to 0.1% of Final Value						
Range A, 200 pF and 2000 pF Load		10		μs	S	PPMU enabled in FV, Range A, DCL disabled; program VIN steps from 0 V to 0.5 V and 5.0 V.
Range B, 200 pF and 2000 pF Load		12		μs	S	PPMU enabled in FV, Range B, DCL disabled; program VIN steps from 0 V to 0.5 V and 5.0 V.
Range C, 200 pF and 2000 pF Load		32		μs	S	PPMU enabled in FV, Range C, DCL disabled; program VIN steps from 0 V to 0.5 V and 5.0 V.
Force Voltage Settling Time to 1.0% of Final Value						
Range A, 200 pF & 2000 pf Load		8.1		μs	C _B	PPMU enabled in FV, Range A, DCL disabled; program VIN steps from 0 V to 5.0 V.
Range B, 200 pF and 2000 pf Load		8.1		μs	C _B	PPMU enabled in FV, Range B, DCL disabled; program VIN steps from 0 V to 5.0 V.
Range C, 200 pF and 2000 pf Load		8.1		μs	C _B	PPMU enabled in FV, Range C, DCL disabled; program VIN steps from 0 V to 5.0 V.

Parameter	Min	Typ	Max	Unit	Test Level	Conditions
Range A, 200 pF and 2000 pf Load		2.5		μs	C _B	PPMU enabled in FV, Range A, DCL disabled; program VIN steps from 0 V to 0.5 V.
Range B, 200 pF and 2000 pf Load		6.3		μs	C _B	PPMU enabled in FV, Range B, DCL disabled; program VIN steps from 0 V to 0.5 V.
Range C, 200 pF and 2000 pf Load		8.1		μs	C _B	PPMU enabled in FV, Range C, DCL disabled; program VIN steps from 0 V to 0.5 V.
Force Current Settling Time to 0.1% of Final Value						
Range A, 200 pF in Parallel with 120 Ω		16		μs	S	PPMU enabled in FI, Range A, DCL disabled; program VIN step of 0 mA to 40 mA.
Range B, 200 pF in Parallel with 1.5 KΩ		10		μs	S	PPMU enabled in FI, Range B, DCL disabled; program VIN step of 0 mA to 1 mA.
Range C, 200 pF in Parallel with 15.0 KΩ		40		μs	S	PPMU enabled in FI, Range C, DCL disabled; program VIN step of 0 mA to 100 μA.
Force Current Settling Time to 1.0% of Final Value						
Range A, 200 pF in Parallel with 120 Ω		8.1		μs	C _B	PPMU enabled in FI, Range A, DCL disabled; program VIN step of 0 mA to 40 mA.
Range B, 200 pF in Parallel with 1.5 KΩ		7.5		μs	C _B	PPMU enabled in FI, Range B, DCL disabled; program VIN step of 0 mA to 1 mA.
Range C, 200 pF in Parallel with 15.0 KΩ		8.1		μs	C _B	PPMU enabled in FI, Range C, DCL disabled; program VIN step of 0 mA to 100 μA.
INTERACTION and CROSSTALK						
Measure Voltage Channel-to-Channel Crosstalk		±0.01		%FSR	C _T	0.01% × 8.5 V = 0.85 mV, PPMU enabled in FIMV, DCL disabled; CHx under test: Range B, forcing 0 mA into 0 V load; other channel: Range A, sweep 0 mA to 40 mA into 0 V load; report ΔV of PPMU_MEASx pin under test.
Measure Current Channel-to-Channel Crosstalk		±0.01		%FSR	C _T	0.01% × 5.0 V = 0.5 mV, PPMU enabled in FVMI, DCL disabled; CHx under test: Range E, forcing 0 V into 0 mA current load; other channel: Range E, sweep -2.0 V to +6.5 V into 0 mA current load; report ΔV of PPMU_MEASx pin under test.

Table 8. PPMU_Go/No-Go Comparators

Parameter	Min	Typ	Max	Unit	Test Level	Conditions
Compare Voltage Range	-2.0		+6.5	V	D	
Input Offset Voltage	-250		+250	mV	P	Measured at DAC Code 0x4000 (0 V)
Input Offset Voltage Tempco		±50		μV/°C	C _T	
Gain	1.0		1.1	V/V	P	Gain derived from measurements at DAC Code 0x4000 (0 V) and DAC Code 0xC000 (+5.0 V)
Gain Tempco		±25		ppm/°C	C _T	Applies at m = 1.0 and c = 0.0
Comparator Threshold Resolution		153		μV	D	
Comparator Threshold DNL		±1		mV	C _T	After two point gain/offset calibration; measured over VOH/VOL range - 2.0 V to +6.5 V; calibration points at 0x4000 (0 V) and 0xC000 (+5 V)
Comparator Threshold INL	-7		+7	mV	P	After two point gain/offset calibration; measured at end points of VOH and VOL functional range
DUTGND Voltage Accuracy	-7	±2	+7	mV	P	Over ±0.1 V range

Parameter	Min	Typ	Max	Unit	Test Level	Conditions
Comparator Uncertainty Band		1.6		mV	C _B	Sweep comparator threshold to determine uncertainty (oscillation) band
DC Hysteresis		<1		mV	C _B	Sweep comparator threshold
COMPARATOR OUTPUTS						
Output Logic High	VDD/4 – 0.5		VDD/4 + 0.5	V	P _F	PPMU_CMPHx, PPMU_CMPLx Sourcing 100 µA
Output Logic Low	0		0.5	V	P _F	Sinking 100 µA

Table 9. PPMU_Sense Pin

Parameter	Min	Typ	Max	Unit	Test Level	Condition
PMU_Sx (SYSTEM PMU) SENSE PIN CHARACTERISTICS						
Voltage Range	–2.0		+7.0	V	D	DCL high-Z compliance range is –2.0 V to +7.0 V
Ext Sense Switch R _{ON}			2.5	kΩ	P	Push 0.5 mA into PMU_Sx with switch closed and DUTx pin at 0 V; calculate R = V/0.0005
Leakage	–2		+2	nA	P	Tested at –2.0 V and +7.0 V, switch open
Pin Capacitance (PMU_Sx)		0.5		pF	S	Switch open
PPMU_Sx (INTERNAL PPMU) SENSE PIN CHARACTERISTICS						
Voltage Range	–2.0		+6.5	V	D	PPMU input select in all states
Leakage	–2		+2	nA	P	Tested at –2.0 V and +6.5 V
Max Load Capacitance		2		nF	S	

Table 10. Serial Programmable Interface (SPI) (SDI, $\overline{\text{RST}}$, $\overline{\text{CS}}$, SCLK, SDO, $\overline{\text{BUSY}}$)

Parameter	Min	Typ	Max	Unit	Test Level	Condition
Input Logic High	1.8		VCC	V	P _F	SDI, $\overline{\text{RST}}$, $\overline{\text{CS}}$, SCLK.
Input Logic Low	0		0.7	V	P _F	
Input Bias Current	–10	±1	+10	µA	P	Tested at 0.0 V and VCC volts.
SCLK Clock Rate	0.5		50	MHz	D	
SCLK Pulse Width, Minimum		9		ns	C _T	
SCLK Crosstalk on DUTx Pin		30		mV	C _B	DCL disabled; PPMU FV enabled and forcing 0.0 V.
Serial Output Logic High	VCC – 0.5		VCC	V	P _F	SDO; sourcing 2 mA.
Serial Output Logic Low	0		0.5	V	P _F	Sinking 2 mA.
$\overline{\text{BUSY}}$ Pull-Up Voltage	2.3	2.5	3.5	V	D	$\overline{\text{BUSY}}$ is an open drain output that pulls low when the SPI requires additional SCLK cycles.
$\overline{\text{BUSY}}$ Active Voltage		0.2	0.8	V	P _F	$\overline{\text{BUSY}}$ active, sinking 2 mA.

Table 11. VHH Driver (VHH Mode Enabled, RCV Active)

Parameter	Min	Typ	Max	Unit	Test Level	Conditions
VHH BUFFER						VHH mode enabled, RCVx active
Voltage Range	0.0		13.5	V	D	
Output High	13.5			V	P	VHH level = full scale, sourcing 15 mA
Output Low			5.9	V	P	VHH level = zero-scale, sinking 15 mA
Extrapolated Offset	-500		+500	mV	P	Extrapolated from measurements at DAC Code 0x8000 (+7 V) and DAC Code 0xC000 (+12 V)
Extrapolated Offset Tempco		±0.5		mV/°C	C _T	
Gain	2		2.2	V/V	P	Gain derived from measurements at DAC Code 0x8000 (+7 V) and DAC Code 0xC000 (+12 V); based on ideal DAC transfer function (see Table 21)
Gain Tempco		±25		ppm/°C	C _T	
Resolution		305		μV	D	
INL	-25		+25	mV	P	VHH mode enabled, RCVx active; after two point gain/offset calibration; measured over +5.9 V to +13.5 V; calibrate at Code 0x8000 (+7 V) and Code 0xC000 (+12 V)
DUTGND Voltage Accuracy		±4		mV	C _T	Over ±0.1 V range; measured at end points of VHH functional range
Output Resistance			10	Ω	P	$\Delta V/\Delta I$; VHH mode enabled, RCVx active; Source: VHH = +10.0 V, I = 0 mA, +15 mA Sink: VHH = +6.5 V, I = 0 mA, -15 mA
DC Output Current Limit Source	+60		+100	mA	P	VHH mode enabled, RCVx active; VHH = +13.5 V, short HVOUT pin to +5.9 V, measure current
DC Output Current Limit Sink	-100		-60	mA	P	VHH mode enabled, RCVx active, VHH = 5.9 V, short HVOUT pin to 13.5 V, measure current
VHH Rise Time (from VIL or VIH to VHH)		163		ns	C _B	20% to 80%, VHH mode enabled, toggle RCVx: VHH = 13.5 V, VIL = 0.0 V, VIH = 3.0 V, DATx = high; VHH = 13.5 V, VIL = 3.0 V, VIH = 4.0 V, DATx = low
VHH Fall Time (from VHH to VIL or VIH)		30		ns	C _B	20% to 80%, VHH mode enabled, toggle RCVx; VHH = 13.5 V, VIL = 0.0 V, VIH = 3.0 V, DATx = high; VHH = 13.5 V, VIL = 3.0 V, VIH = 4.0 V, DATx = low
Preshoot, Overshoot, and Undershoot		±40.0		mV	C _B	VHH mode enabled, toggle RCVx; VHH = 13.5 V, VIL = 0.0 V, VIH = 3.0 V, DATx = high; VHH = 13.5 V, VIL = 3.0 V, VIH = 4.0 V, DATx = low
VIL/VIH DRIVE FUNCTION						VHH mode enabled, RCVx inactive
Voltage Range	-0.1		+6.5	V	D	
Offset Voltage	-500		+500	mV	P	Measured at DAC Code 0x4000 (0 V), for DATx = high and DATx = low
Offset Voltage Tempco		1		mV/°C	C _T	
Gain	1.0		1.1	V/V	P	Gain derived from measurements at DAC Code 0x4000 (0 V) and DAC Code 0xC000 (5 V); based on ideal DAC transfer function (see Table 21)
Gain Tempco		±75		ppm/°C	C _T	
Resolution		153		μV	D	
INL	-20		+20	mV	P	VHH mode enabled, RCVx inactive; after two point gain/offset calibration; measured over -0.1 V to +6.0 V; calibrate at Code 0x4000 (0 V) and Code 0xC000 (+5.0 V)

Parameter	Min	Typ	Max	Unit	Test Level	Conditions
DUTGND Voltage Accuracy		±2		mV	C _T	Over ±0.1 V range; measured at end points of VIH and VIL functional range
Output Resistance	46	48	50	Ω	P	ΔV/ΔI; VHH mode enabled, RCVx inactive; Source: VIH = +3.0 V, I = +1 mA, +50 mA; Sink: VIL = +2.0 V; I = -1 mA, -50 mA
DC Output Current Limit Source	60		100	mA	P	VHH mode enabled, RCVx inactive, VIH = +6.0 V, short HVOUT pin to -0.1 V, DATx high, measure current
DC Output Current Limit Sink	-100		-60	mA	P	VHH mode enabled, RCVx inactive, VIL = -0.1 V, short HVOUT pin to +6.0 V, DATx low, measure current
Rise Time, VIL to VIH		6.4		ns	C _B	20% to 80%, VHH mode enabled, RCVx inactive, VIL = 0.0 V, VIH = 3.0 V, R _{LOAD} > 500 Ω, toggle DATx
Fall Time, VIH to VIL		7.3		ns	C _B	20% to 80%, VHH mode enabled, RCVx inactive, VIL = 0.0 V, VIH = 3.0 V, R _{LOAD} > 500 Ω, toggle DATx
Preshoot, Overshoot, and Undershoot		±30		mV	C _B	VHH mode enabled, RCVx inactive, VIL = 0.0 V, VIH = 3.0 V, R _{LOAD} > 500 Ω, toggle DATx

Table 12. Alarm Functions

Parameter	Min	Typ	Max	Unit	Test Level	Condition
DC CHARACTERISTICS						
Overvoltage Detect (OVD)						See Figure 137
Programmable Voltage Range	-2.5		+7.5	V	D	
Uncalibrated Error at -2.0 V	-200		+200	mV	P	Measured at DAC Code 0x0CCC (-2.0 V); OVD comparators not guaranteed to function as specified if VDUTx is outside absolute maximum voltage range
Uncalibrated Error at +7.0 V	-450		+450	mV	P	Measured at DAC Code 0xF333 (+7.0 V)
Offset Voltage Tempco		±0.5		mV/°C	C _T	Gain derived from measurements at DAC Code 0x4000 and DAC Code 0xC000
Gain		1.045		V/V	C _T	
Hysteresis		125		mV	C _T	
Thermal Alarm						See Figure 137
Setpoint Error		±10		°C	C _T	Relative to default value, 100°C
Thermal Hysteresis		-15		°C	C _T	
PPMU Clamp Alarm						See Figure 137 and Table 29 for electrical characteristics
ALARM Output Characteristics						
Off State Leakage		10	500	nA	P	Disable alarm, apply 2.5 V to $\overline{\text{ALARM}}$ pin, measure leakage current
Max On Voltage at 100 μA		0.1	0.7	V	P	Activate alarm, force 100 μA into $\overline{\text{ALARM}}$ pin, measure active alarm voltage
Propagation Delay		1.5		μs	C _B	For OVD_HI: VDUTx: 0 V to 6 V swing, OVDH = +3.0 V, OVDL = -1.0 V For OVD_LO: VDUTx: 0 V to 6 V swing, OVDH = +7.0 V, OVDL = +3.0 V

SPI TIMING DETAILS

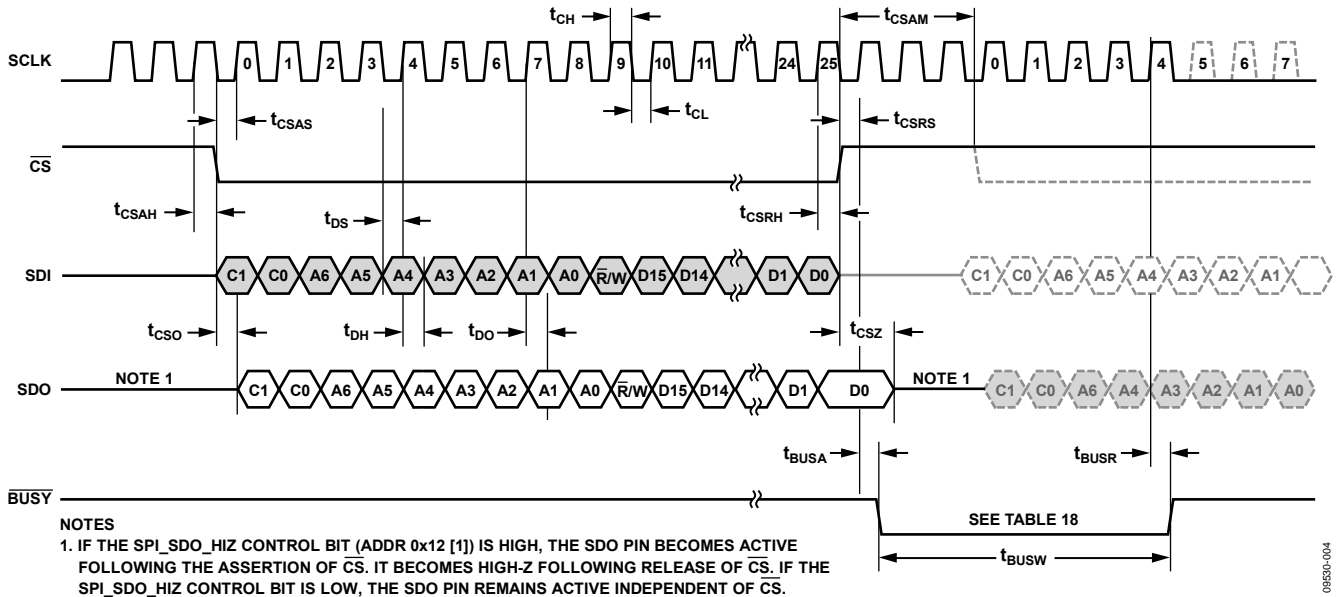

Figure 2. SPI Detailed Read/Write Timing Diagram

09530-004

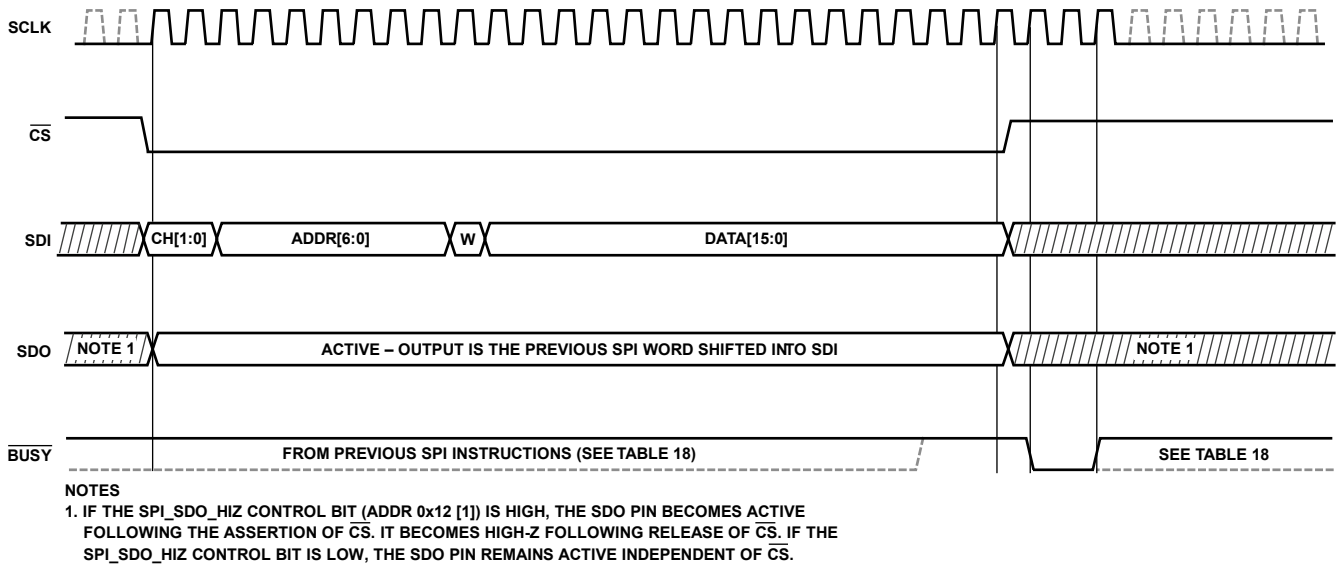

Figure 3. SPI Write Instruction

09530-005

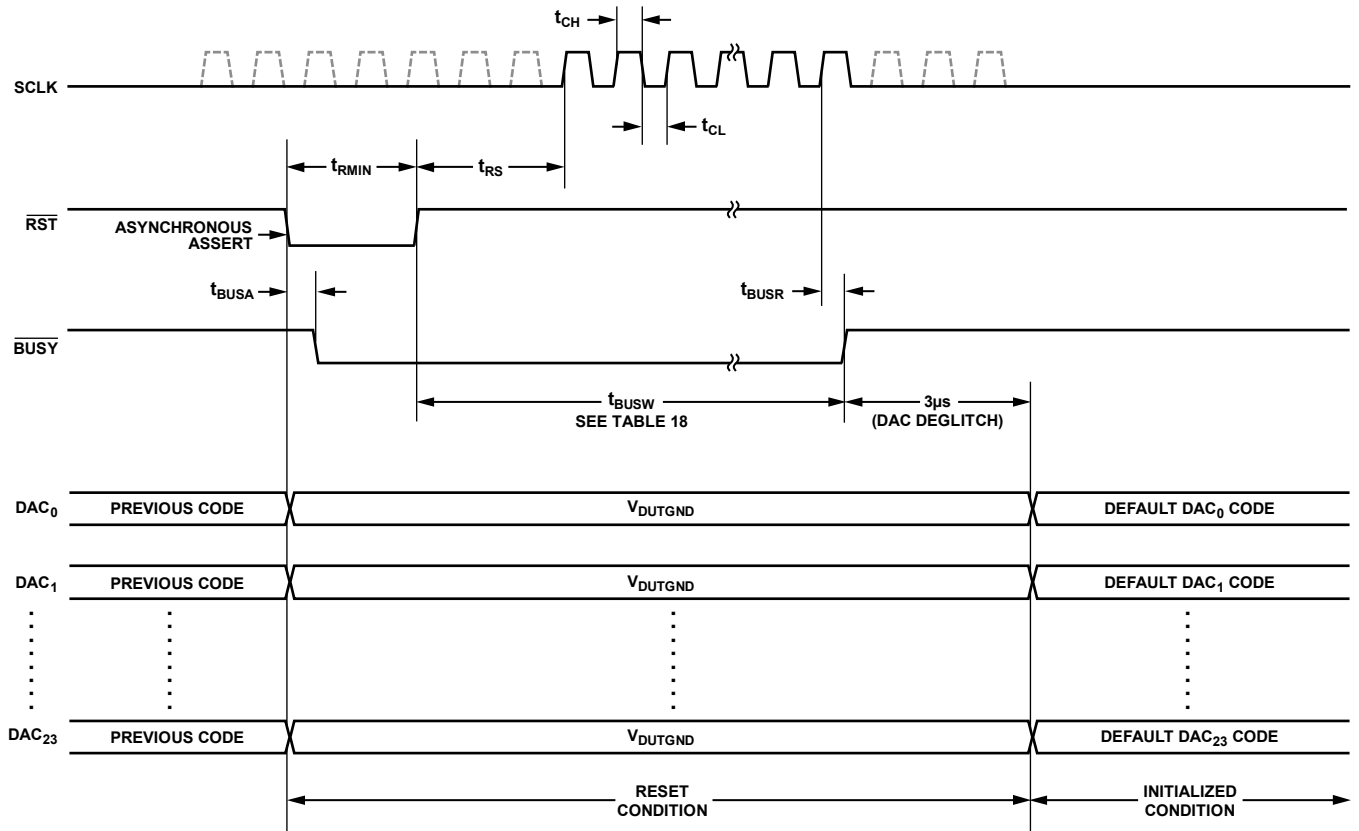

Figure 4. SPI Detailed Hardware Reset Timing Diagram

09534-006

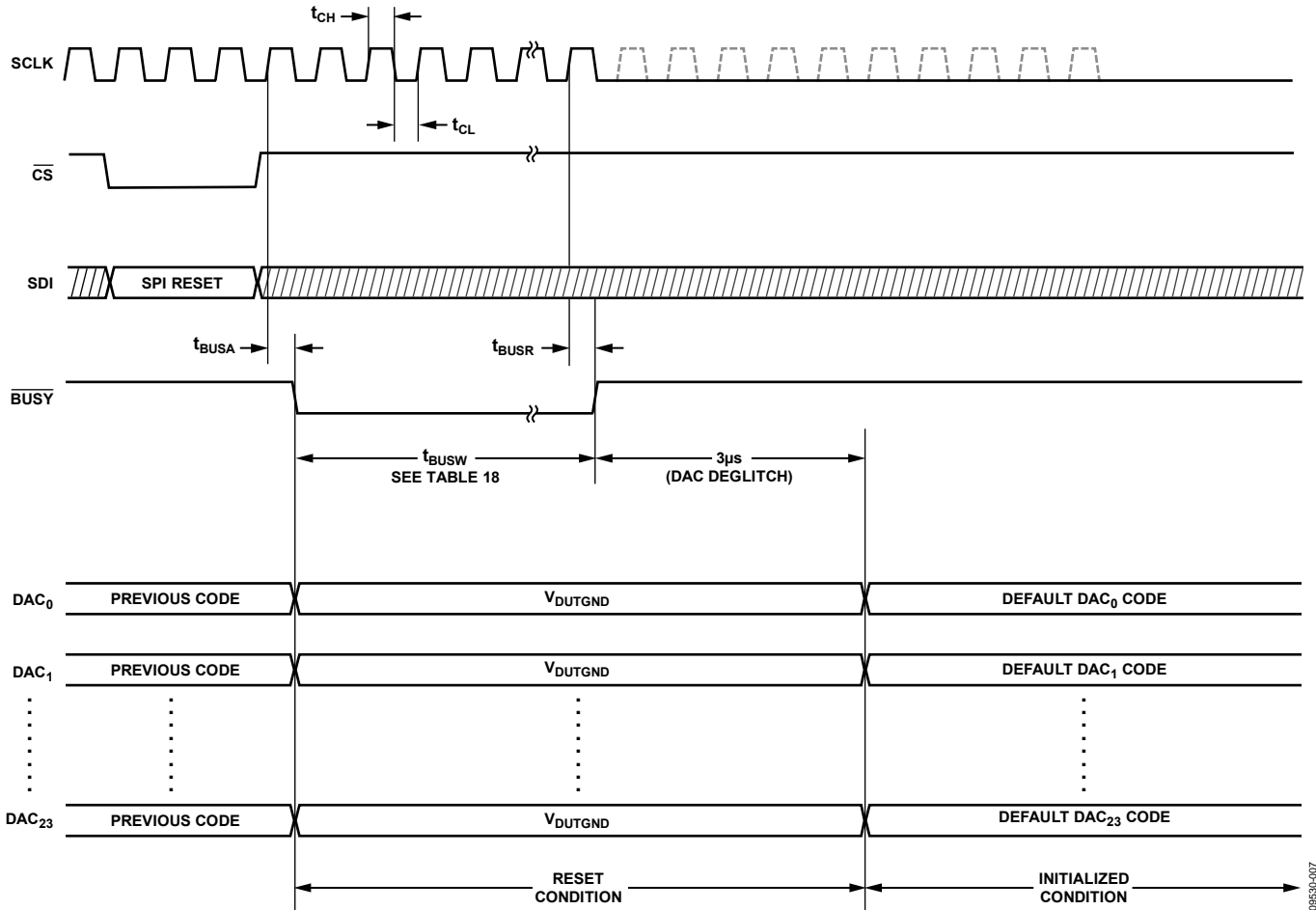
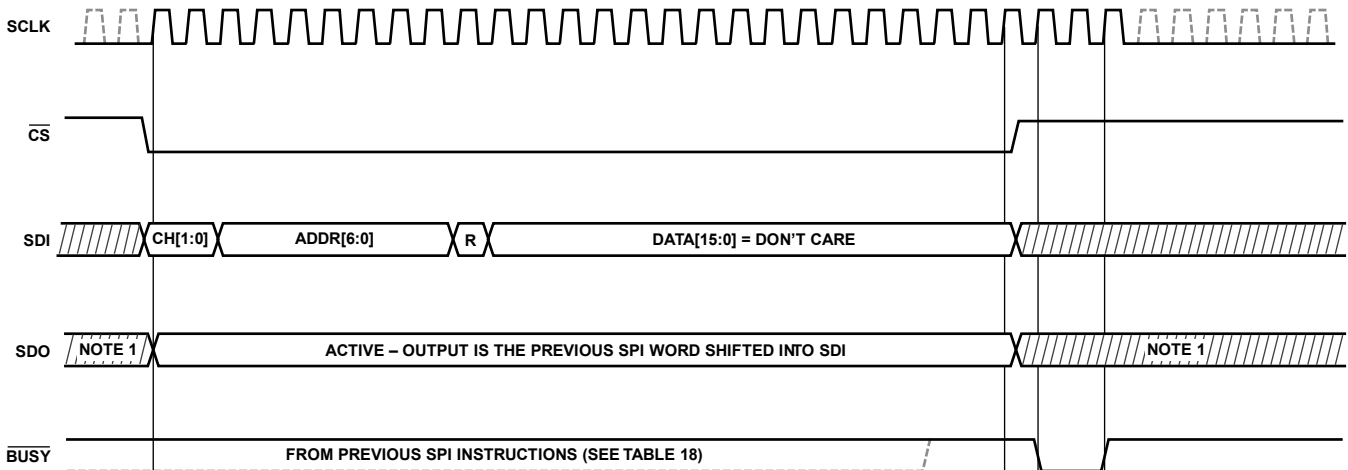

Figure 5. SPI Detailed Software Reset Timing Diagram

09530-007



NOTES
 1. IF THE SPI_SDO_HIZ CONTROL BIT (ADDR 0x12 [1]) IS HIGH, THE SDO PIN BECOMES ACTIVE FOLLOWING THE ASSERTION OF CS. IT BECOMES HIGH-Z FOLLOWING RELEASE OF CS. IF THE SPI_SDO_HIZ CONTROL BIT IS LOW, THE SDO PIN ALWAYS REMAINS ACTIVE INDEPENDENT OF CS.

Figure 6. SPI Read Request Instruction (Prior to Readout)

09530-008

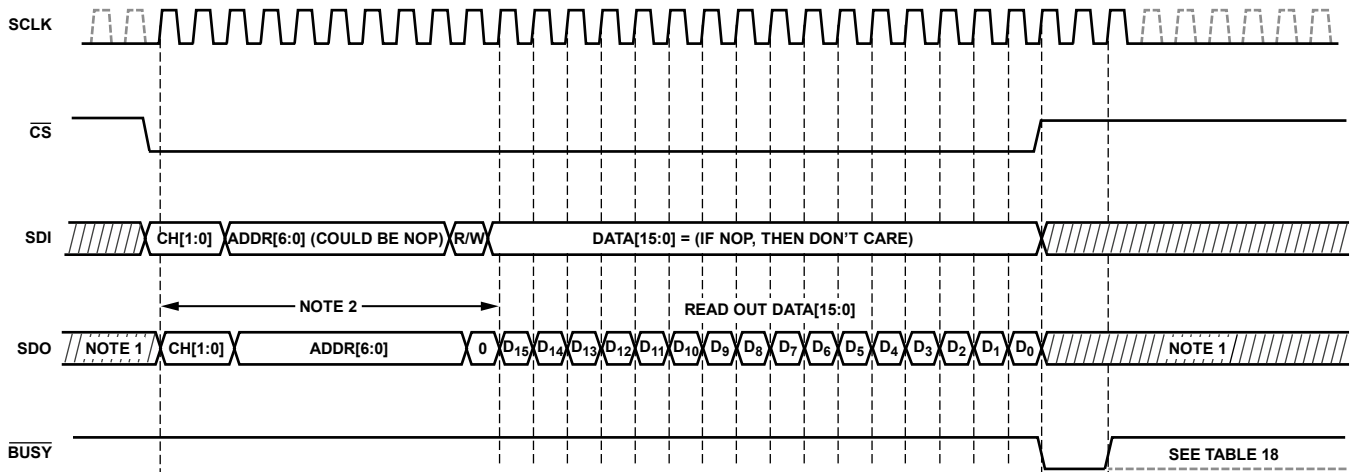

NOTES

1. IF THE SPI_SDO_HIZ CONTROL BIT (ADDR 0x12 [1]) IS HIGH, THE SDO PIN BECOMES ACTIVE FOLLOWING THE ASSERTION OF CS. IT BECOMES HIGH-Z FOLLOWING RELEASE OF CS. IF THE SPI_SDO_HIZ CONTROL BIT IS LOW, THE SDO PIN REMAINS ACTIVE INDEPENDENT OF CS.
2. THE FIRST 10 BITS OF SDO FOLLOWING A READ REQUEST ECHO ADDRESS AND CHANNEL BITS OF THE PRECEDING REQUEST. THE R/W BIT POSITION IS SET LOW. THE FOLLOWING 16 BITS CONTAIN DATA FROM THE REQUESTED ADDRESS AND CHANNEL.

Figure 7. SPI Readout Instruction (Subsequent to Read Request)

09530-009

Table 13. SPI Detailed Timing Requirements

Parameter	Min	Max	Unit	Test Level	Description
f _{CLK}	0.5	50	MHz	C _T	SCLK operating frequency.
t _{CH}	9		ns	C _T	SCLK high time.
t _{CL}	9		ns	C _T	SCLK low time.
t _{CSAS}	3		ns	C _T	Setup of \overline{CS} to rising SCLK at assert.
t _{CSAH}	3		ns	C _T	Hold of \overline{CS} to rising SCLK at assert.
t _{CSRS}	3		ns	C _T	Setup of \overline{CS} to rising SCLK at release.
t _{CSRH}	3		ns	C _T	Hold of \overline{CS} to rising SCLK at release.
	4		ns	C _T	Hold of \overline{CS} release prior to rising SCLK. This parameter is critical only if the number of SCLK cycles from the previous release of \overline{CS} is the minimum specified by the t _{CSAM} parameter.
t _{CSO}		6	ns	C _T	Delay from \overline{CS} assert to SDO active.
t _{CSZ}		10	ns	C _T	Delay from \overline{CS} release to SDO high-Z, depends greatly on external pin loading.
t _{CSAM}	3		Cycles	C _T	Width of \overline{CS} release between consecutive assertions of \overline{CS} . This parameter is specified in units of SCLK cycles, more specifically in terms of rising edges of the SCLK input.
t _{DS}	3		ns	C _T	Setup of SDI data prior to rising SCLK.
t _{DH}	4		ns	C _T	Hold of SDI data following rising SCLK.
t _{DO}		12	ns	C _T	Delay of SDO data from rising SCLK.
t _{BUSA}		12	ns	C _T	Delay of \overline{BUSY} assert from first rising SCLK following a valid \overline{CS} release or an asynchronous RSTb release.
t _{BUSW}	3	26	Cycles	C _T	Width of \overline{BUSY} assert. To ensure proper SPI operation, the SCLK must be provided for as long as \overline{BUSY} remains asserted. Note that the number of SCLK cycles within any \overline{BUSY} period is variable but deterministic and is based on the previous SPI write instruction type. See the Use of the SPI \overline{BUSY} Pin section and Figure 2, Figure 4, Figure 5, and Table 18 for more information.
t _{BUSR}		12	ns	C _T	Delay of \overline{BUSY} release from first rising SCLK, satisfying the requirements detailed in the Use of the SPI \overline{BUSY} Pin section.
t _{RMIN}	10		ns	C _T	Width of asynchronous \overline{RST} assert.
t _{RS}	3		ns	C _T	Setup of \overline{RST} to rising SCLK at release.
t _{SPI}	29		Cycles	C _T	Number of SCLK rising edge cycles per SPI word write plus the additional t _{CSAM} requirement.
t _{DAC}	5	10	μs	S	Settling time of analog DAC levels to ±0.5 LSB relative to the beginning of the DAC deglitch period, which begins x SCLK cycles following the release of \overline{CS} and four SCLK cycles prior to the release of the \overline{BUSY} pin. The number of SCLK cycles, x, is defined by Table 18. Also see Figure 126 for more information.

ABSOLUTE MAXIMUM RATINGS

Table 14. Absolute Maximum Ratings

Parameter	Rating
Supply Voltages	
Positive Supply Voltage (VDD to PGND)	−0.5 V to +11.0 V
Positive VCC Supply Voltage (VCC to DGND)	−0.5 V to +4.0 V
Negative Supply Voltage (VSS to PGND)	−6.5 V to +0.5 V
Supply Voltage Difference (VDD to VSS)	−1.0 V to +17.0 V
Reference Ground (DUTGND to AGND)	−0.5 V to +0.5 V
VPLUS Supply Voltage (VPLUS to PGND)	−0.5 V to +19.0 V
Supply Sequence or Dropout Condition ¹	
Input/Output Voltages	
Analog Input Common-Mode Voltage	VSS to VDD
DUTx Output Short Circuit Voltage ²	−3.0 V to +8.0 V
High Speed Input Voltage Absolute Range ³	−0.5 V to VTTC + 0.5 V
High Speed Differential Input Voltage ³	−1.0 V to +1.0 V
DUTx I/O Pin Current	
DCL Maximum Short-Circuit Current ⁴	±140 mA
Temperature	
Operating Temperature, Junction	125°C
Storage Temperature Range	−65°C to +150°C

¹ No supply should exceed the given ratings.

² $R_{LOAD} = 0 \Omega$, VDUTx continuous short-circuit condition (VIH, VIL, VIT), high-Z, VCOM, and clamp modes).

³ DAT, DAT, RCV, RCV, $R_{SOURCE} = 0 \Omega$.

⁴ $R_{LOAD} = 0 \Omega$, VDUTx = −3 V to +8 V; DCL current limit. Continuous short-circuit condition. ADATE318 current limits and survives a continuous short-circuit fault.

Stresses at or above those listed under Absolute Maximum Ratings may cause permanent damage to the product. This is a stress rating only; functional operation of the product at these or any other conditions above those indicated in the operational section of this specification is not implied. Operation beyond the maximum operating conditions for extended periods may affect product reliability.

THERMAL RESISTANCE

θ_{JA} is specified for the worst-case conditions, that is, a device soldered in a circuit board for surface-mount packages.

Table 15. Thermal Resistance

Package Type	θ_{JA}			θ_{JC}	Unit
	0	1	2		
Airflow	0	1	2	1	m/s
LFCSF	45	40	37	1	°C/W

Table 16. Explanation of Test Levels

Test Level	Description
D	Definition
S	Design verification simulation
P	100% production tested
P _F	Functionally checked during production test
C _T	Characterized on tester
C _B	Characterized on bench

ESD CAUTION



ESD (electrostatic discharge) sensitive device. Charged devices and circuit boards can discharge without detection. Although this product features patented or proprietary protection circuitry, damage may occur on devices subjected to high energy ESD. Therefore, proper ESD precautions should be taken to avoid performance degradation or loss of functionality.

PIN CONFIGURATION AND FUNCTION DESCRIPTIONS

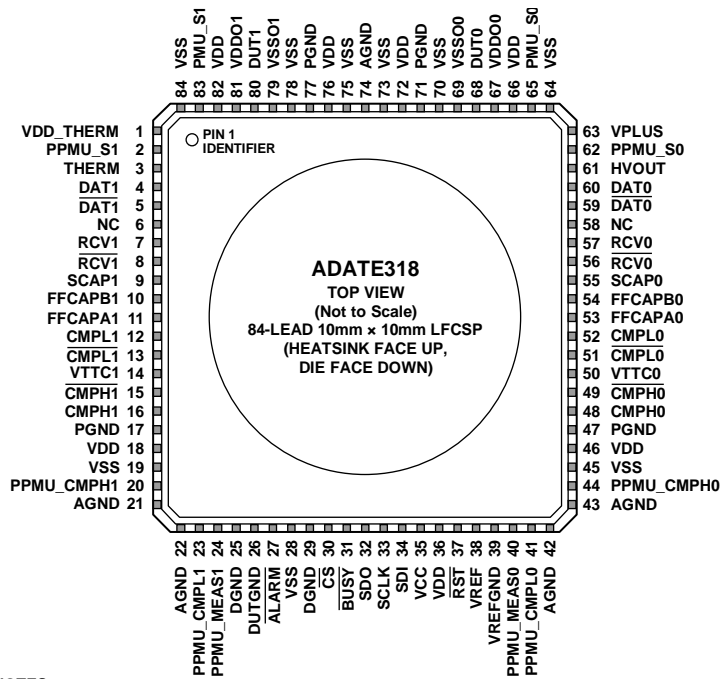

- NOTES**
 1. EXPOSED PADDLE IS INTERNALLY CONNECTED VIA HIGH IMPEDANCE TO VSS (SUBSTRATE).
 2. NC = THIS PIN IS OPEN. NO INTERNAL CONNECTION.

09530-1002

Figure 8. LFCSP Pin Configuration

Table 17. Pin Function Descriptions

Pin	Mnemonic	Description
EP	Exposed Paddle	Exposed paddle is internally connected via high impedance to VSS (substrate).
1	VDD_THERM	Temperature Sensor VDD Supply.
2	PPMU_S1	PPMU External Sense Connect, Channel 1.
3	THERM	Temperature Sensor Analog Output.
4	DAT1	High Speed Data Input, Channel 1.
5	DAT1	High Speed Data Input Complement, Channel 1.
6	NC	This pin is open. No internal connection.
7	RCV1	High Speed Receive Input, Channel 1.
8	RCV	High Speed Receive Input Complement, Channel 1.
9	SCAP1	PPMU External Compensation Capacitor, Channel 1.
10	FFCAPB1	PPMU External Feed Forward Capacitor Pin B, Channel 1.
11	FFCAPA1	PPMU External Feed Forward Capacitor Pin A, Channel 1.
12	CMPL1	High Speed Comparator Low Output, Channel 1.
13	CMPL1	High Speed Comparator Low Output Complement, Channel 1.
14	VTTC1	Comparator Supply Termination, Channel 1.
15	CMPH1	High Speed Comparator High Output Complement, Channel 1.
16	CMPH1	High Speed Comparator High Output, Channel 1.
17	PGND	Power Ground.
18	VDD	VDD Supply.
19	VSS	VSS Supply.
20	PPMU_CMPH1	PPMU Go/No-Go Comparator High Output, Channel 1.
21	AGND	Analog Ground.
22	AGND	Analog Ground.
23	PPMU_CMPL1	PPMU Go/No-Go Comparator Low Output, Channel 1.

Pin	Mnemonic	Description
24	PPMU_MEAS1	PPMU Analog Measure Output, Channel 1.
25	DGND	Digital Logic Ground.
26	DUTGND	DUT Ground Sense Input.
27	ALARM	Fault Alarm Open Drain Output.
28	VSS	VSS Supply.
29	DGND	Digital Logic Ground.
30	\overline{CS}	Serial Programmable Interface (SPI) Chip Select Input (Active Low).
31	\overline{BUSY}	Serial Programmable Interface (SPI) Busy Output (Active Low).
32	SDO	Serial Programmable Interface (SPI) Serial Data Output.
33	SCLK	Serial Programmable Interface (SPI) Clock Input.
34	SDI	Serial Programmable Interface (SPI) Serial Data Input.
35	VCC	VCC Supply.
36	VDD	VDD Supply.
37	\overline{RST}	Reset Input (Active Low).
38	VREF	DAC Precision +5.0 V Reference Input.
39	VREFGND	DAC Precision +0.0 V Reference Input.
40	PPMU_MEAS0	PPMU Analog Measure Output, Channel 0.
41	PPMU_CMPLO	PPMU Go/No-Go Comparator Low Output, Channel 0.
42	AGND	Analog Ground.
43	AGND	Analog Ground.
44	PPMU_CMPHO	PPMU Go/No-go Comparator High Output, Channel 0.
45	VSS	VSS Supply.
46	VDD	VDD Supply.
47	PGND	Power Ground.
48	CMPHO	High Speed Comparator High Output, Channel 0.
49	\overline{CMPHO}	High Speed Comparator High Output Complement, Channel 0.
50	VTT0	Comparator Supply Termination, Channel 0.
51	$\overline{CMPL0}$	High Speed Comparator Low Output Complement, Channel 0.
52	CMPL0	High Speed Comparator Low Output, Channel 0.
53	FFCAPA0	PPMU External Feed Forward Capacitor Pin A, Channel 0.
54	FFCAPB0	PPMU External Feed Forward Capacitor Pin B, Channel 0.
55	SCAP0	PPMU External Compensation Capacitor, Channel 0.
56	$\overline{RCV0}$	High Speed Receive Input Complement, Channel 0.
57	RCV0	High Speed Receive Input, Channel 0.
58	NC	This pin is open. No internal connection.
59	$\overline{DAT0}$	High Speed Data Input Complement, Channel 0.
60	DAT0	High Speed Data Input, Channel 0.
61	HVOUT	VHH Output Pin.
62	PPMU_S0	PPMU External Sense Connect, Channel 0.
63	VPLUS	VPLUS Supply.
64	VSS	VSS Supply.
65	PMU_S0	System PMU Sense Input, Channel 0.
66	VDD	VDD Supply.
67	VDDO0	VDD Supply, Driver Output Stage, Channel 0.
68	DUT0	DUT Pin, Channel 0.
69	VSSO0	VSS Supply, Driver Output Stage, Channel 0.
70	VSS	VSS Supply.
71	PGND	Power Ground.
72	VDD	VDD Supply.
73	VSS	VSS Supply.
74	AGND	Analog Ground.

Pin	Mnemonic	Description
75	VSS	VSS Supply.
76	VDD	VDD Supply.
77	PGND	Power Ground.
78	VSS	VSS Supply.
79	VSSO1	VSS Supply, Driver Output Stage, Channel 1.
80	DUT1	DUT Pin, Channel 1.
81	VDDO1	VDD Supply, Driver Output Stage, Channel 1.
82	VDD	VDD Supply.
83	PMU_S1	System PMU Sense Input, Channel 1.
84	VSS	VSS Supply.

TYPICAL PERFORMANCE CHARACTERISTICS

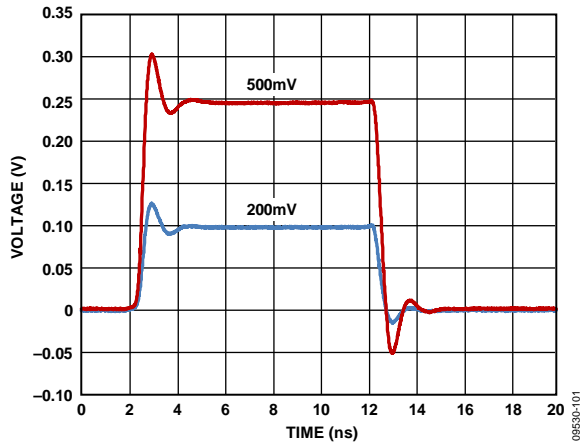

Figure 9. Driver Small Signal Response, $V_{IH} = 0.2\text{ V}$, 0.5 V , $V_{IL} = 0.0\text{ V}$, $50\ \Omega$ Termination

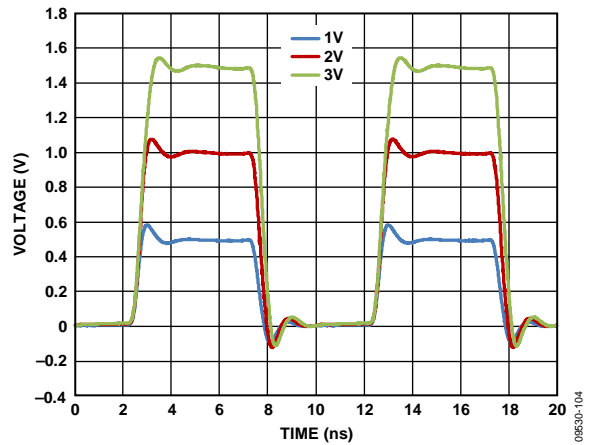

Figure 12. 100 MHz Driver Response, $V_{IH} = 1.0\text{ V}$, 2.0 V , 3.0 V ; $V_{IL} = 0.0\text{ V}$, $50\ \Omega$ Termination

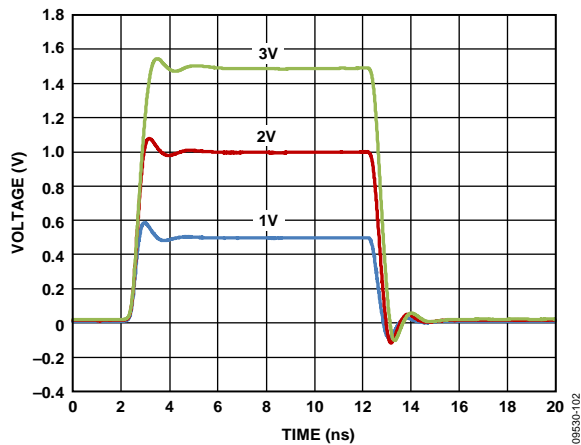

Figure 10. Driver Large Signal Response, $V_{IH} = 1.0\text{ V}$, 2.0 V , 3.0 V ; $V_{IL} = 0.0\text{ V}$, $50\ \Omega$ Termination

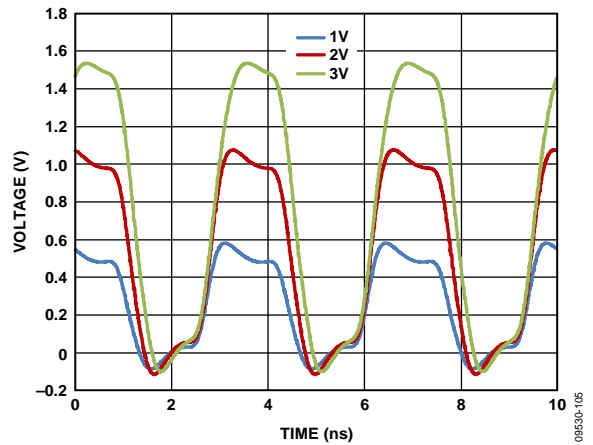

Figure 13. 300 MHz Driver Response, $V_{IH} = 1.0\text{ V}$, 2.0 V , 3.0 V ; $V_{IL} = 0.0\text{ V}$, $50\ \Omega$ Termination

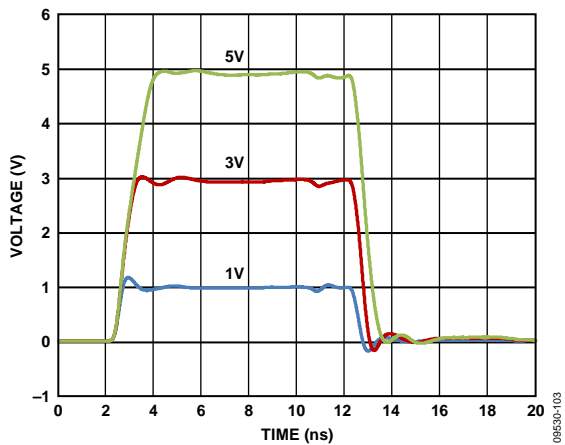

Figure 11. Driver Large Signal Response, $V_{IH} = 1.0\text{ V}$, 3.0 V , 5.0 V ; $V_{IL} = 0.0\text{ V}$, $50\ \Omega$ unterminated

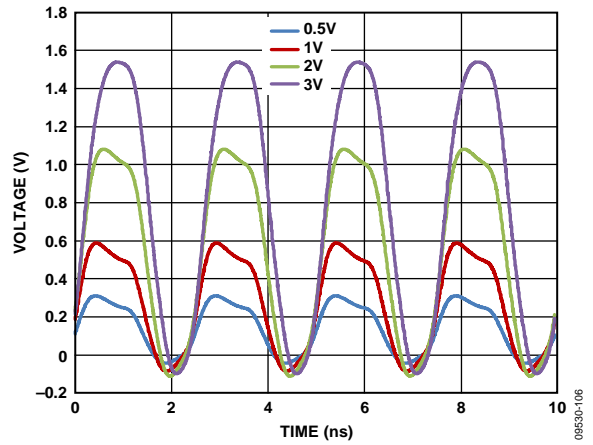

Figure 14. 400 MHz Driver Response, $V_{IH} = 0.5\text{ V}$, 1.0 V , 2.0 V , 3.0 V ; $V_{IL} = 0.0\text{ V}$, $50\ \Omega$ Termination

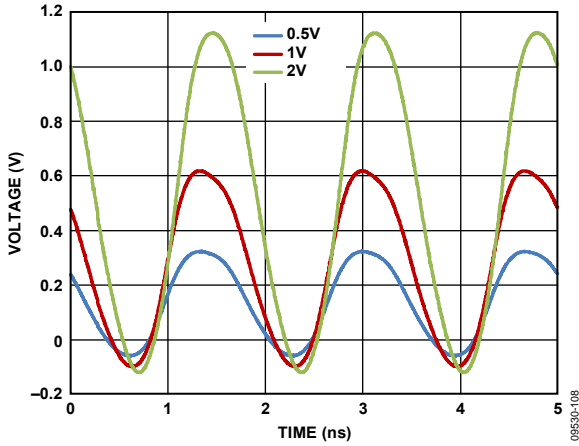

Figure 15. 600 MHz Driver Response, $V_{IH} = 0.5\text{ V}$, 1.0 V , 2.0 V ; $V_{IL} = 0.0\text{ V}$, $50\ \Omega$ Termination

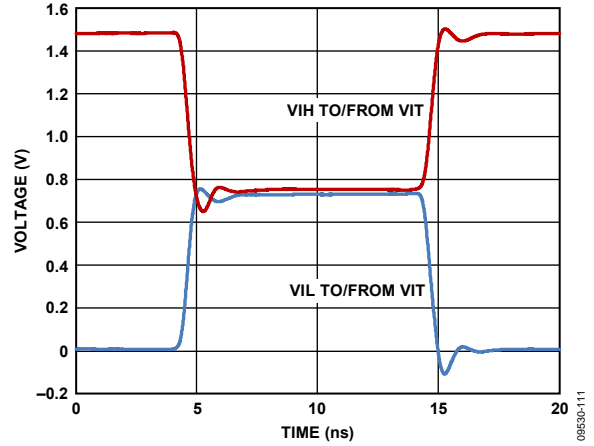

Figure 18. Driver Active (V_{IH}/V_{IL}) to/from V_{TERM} Transition; $V_{IH} = 3.0\text{ V}$, $V_{IT} = 1.5\text{ V}$; $V_{IL} = 0.0\text{ V}$, $50\ \Omega$ Termination

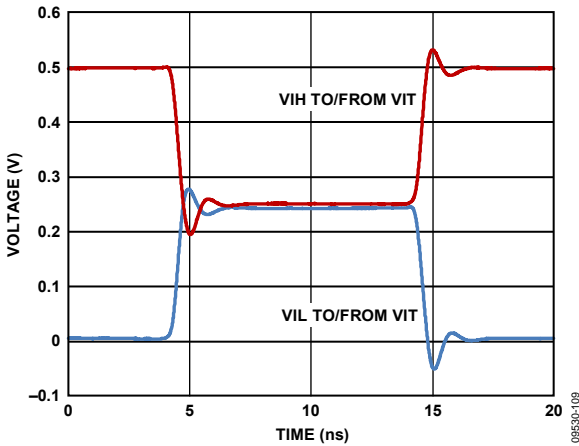

Figure 16. Driver Active (V_{IH}/V_{IL}) to/from V_{TERM} Transition; $V_{IH} = 1.0\text{ V}$, $V_{IT} = 0.5\text{ V}$; $V_{IL} = 0.0\text{ V}$, $50\ \Omega$ Termination

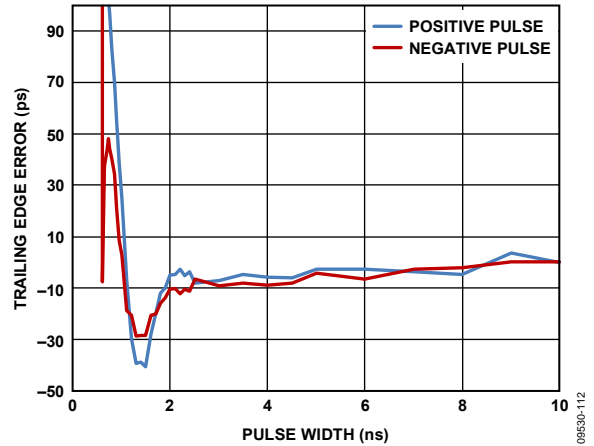

Figure 19. Driver Trailing Edge Timing Error Pulse Width, $V_{IH} = 0.2\text{ V}$; $V_{IL} = 0.0\text{ V}$, $50\ \Omega$ Termination

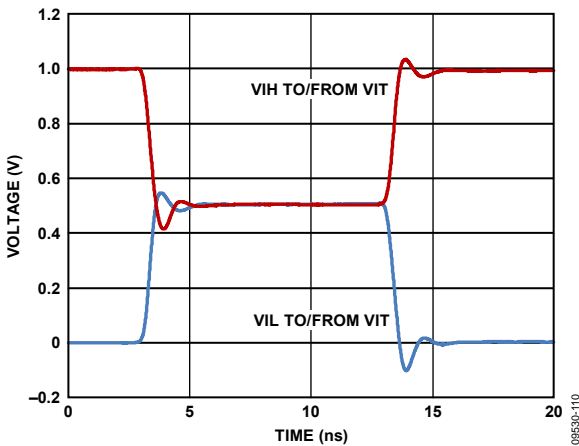

Figure 17. Driver Active (V_{IH}/V_{IL}) to/from V_{TERM} Transition; $V_{IH} = 2.0\text{ V}$, $V_{IT} = 1.0\text{ V}$; $V_{IL} = 0.0\text{ V}$, $50\ \Omega$ Termination

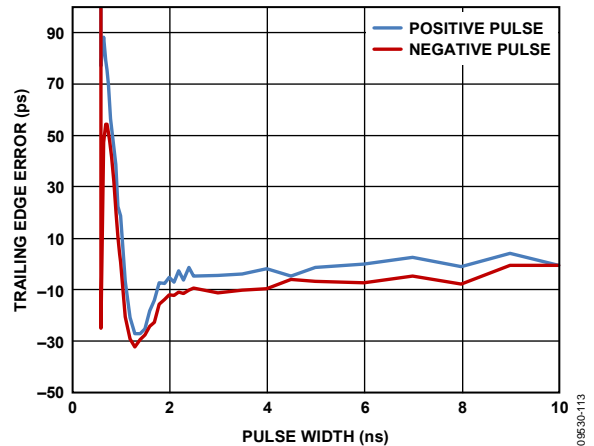

Figure 20. Driver Trailing Edge Timing Error vs. Pulse Width, $V_{IH} = 0.5\text{ V}$; $V_{IL} = 0.0\text{ V}$, $50\ \Omega$ Termination

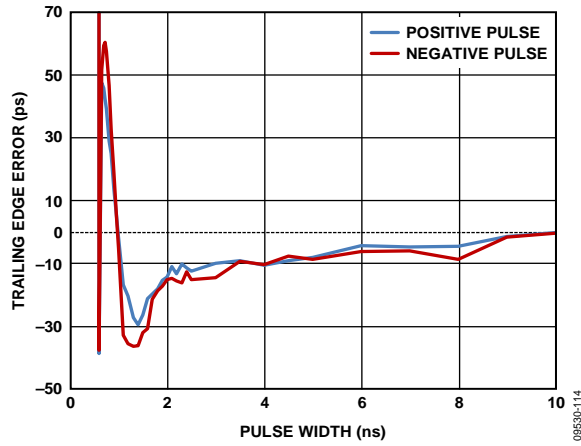

Figure 21. Driver Trailing Edge Timing Error vs. Pulse Width, $V_{IH} = 1.0\text{ V}$; $V_{IL} = 0.0\text{ V}$, $50\ \Omega$ Termination

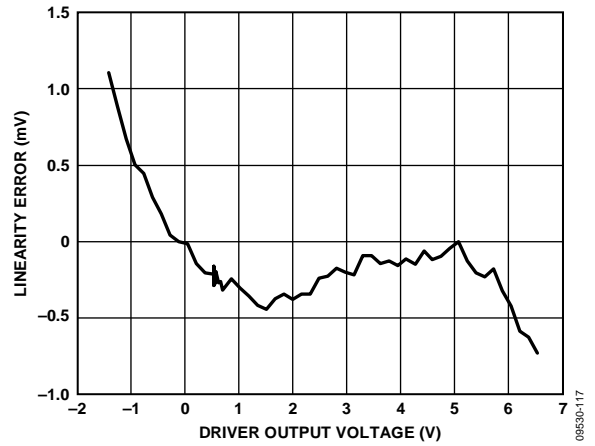

Figure 24. Driver V_{IH} Linearity Error

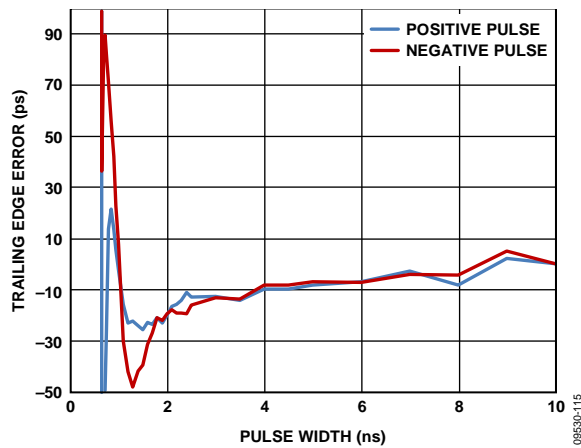

Figure 22. Driver Trailing Edge Timing Error vs. Pulse Width, $V_{IH} = 2.0\text{ V}$; $V_{IL} = 0.0\text{ V}$, $50\ \Omega$ Termination

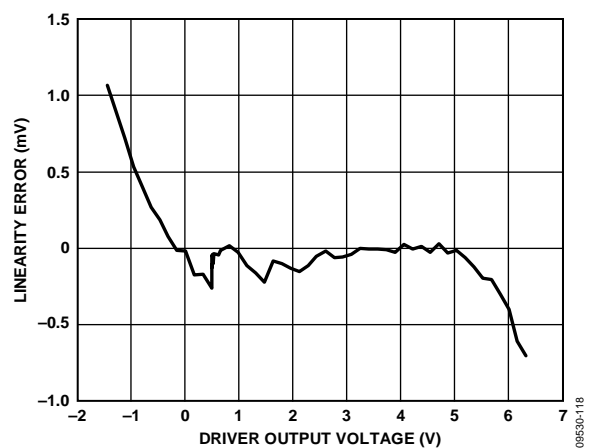

Figure 25. Driver V_{IL} Linearity Error

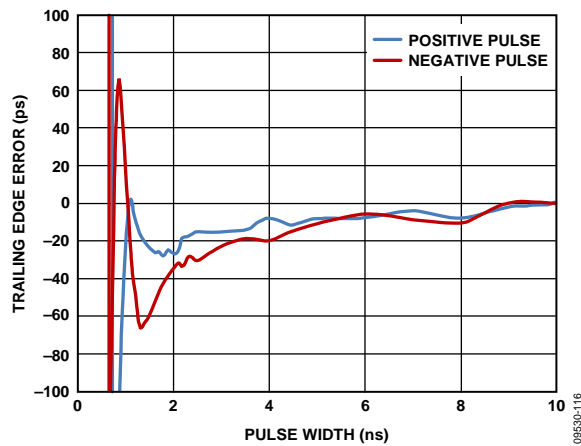

Figure 23. Driver Trailing Edge Timing Error vs. Pulse Width, $V_{IH} = 3.0\text{ V}$; $V_{IL} = 0.0\text{ V}$, $50\ \Omega$ Termination

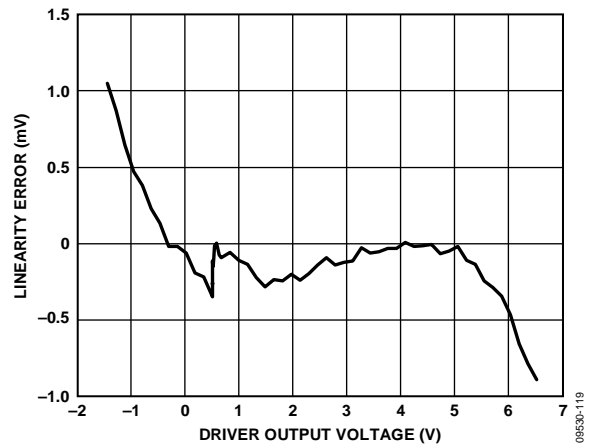

Figure 26. Driver V_{IT} Linearity Error

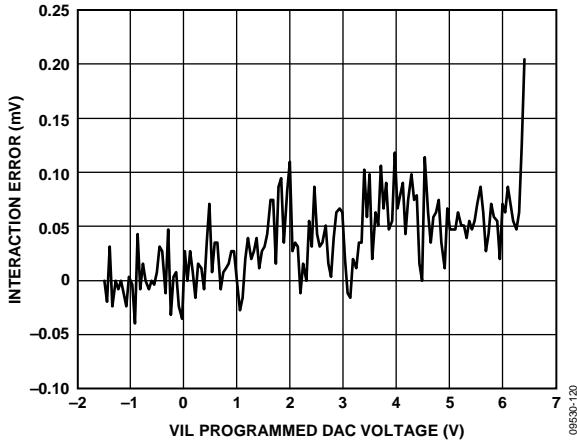

Figure 27. Driver Interaction Error V_{IH} vs. V_{IL} , $V_{IH} = +6.5 V$, V_{IL} Swept from $-1.5 V$ to $+6.5 V$

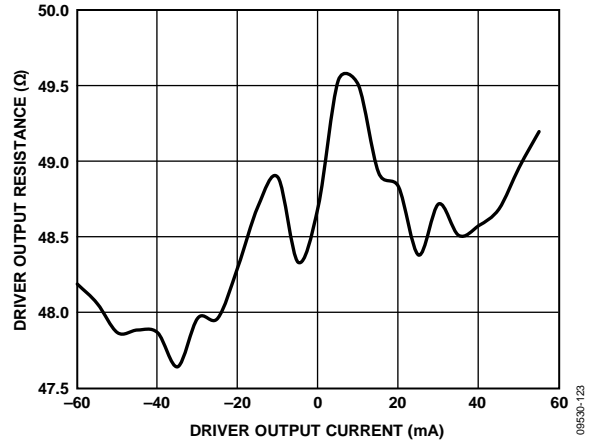

Figure 30. Driver Output Resistance vs. Output Current

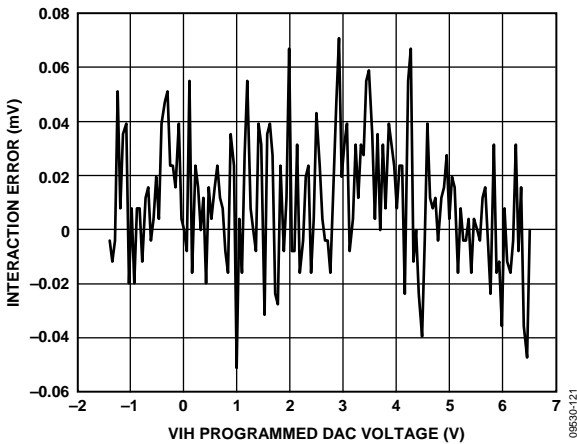

Figure 28. Driver Interaction Error V_{IL} vs. V_{IH} ; $V_{IL} = -1.5 V$, V_{IH} Swept from $-1.5 V$ to $+6.5 V$

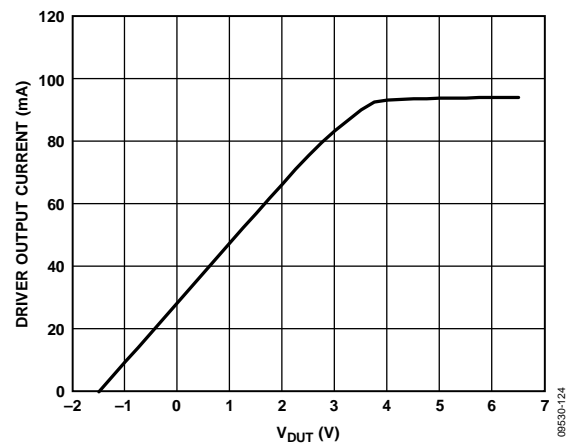

Figure 31. Driver Output Current Limit; Driver Programmed to $-1.5 V$, V_{DUT} Swept $-1.5 V$ to $+6.5 V$

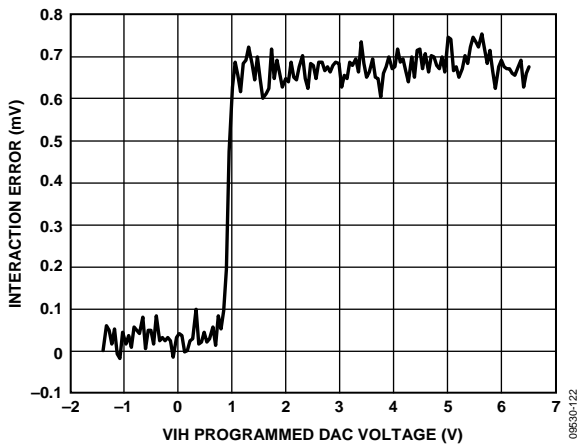

Figure 29. Driver Interaction Error V_{IT} vs. V_{IH} , $V_{IT} = +1.0 V$, V_{IH} Swept from $-1.5 V$ to $+6.5 V$

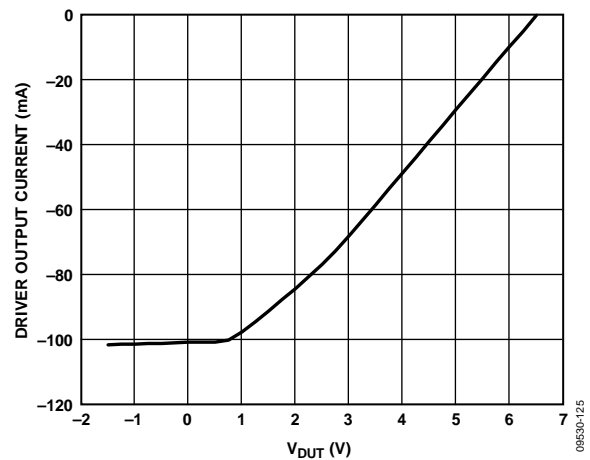

Figure 32. Driver Output Current Limit. Driver Programmed to $6.5 V$, V_{DUT} Swept $-1.5 V$ to $+6.5 V$

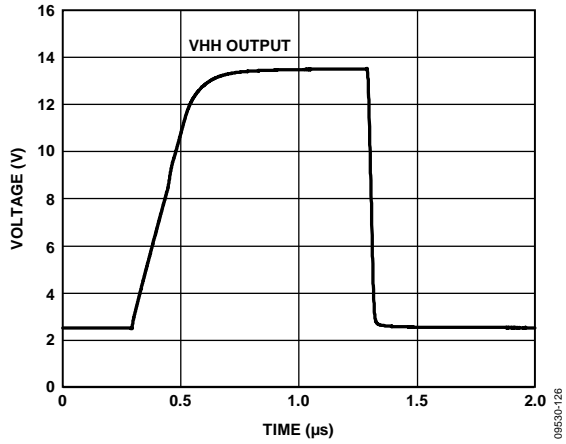

Figure 33. HVOUT Transient Response, VHH = 13.5 V

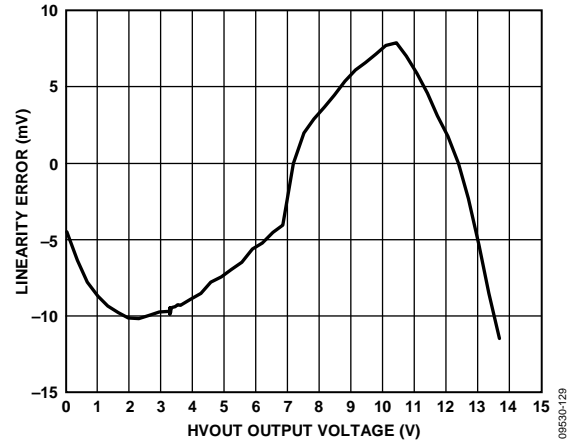

Figure 36. HVOUT VHH Linearity Error

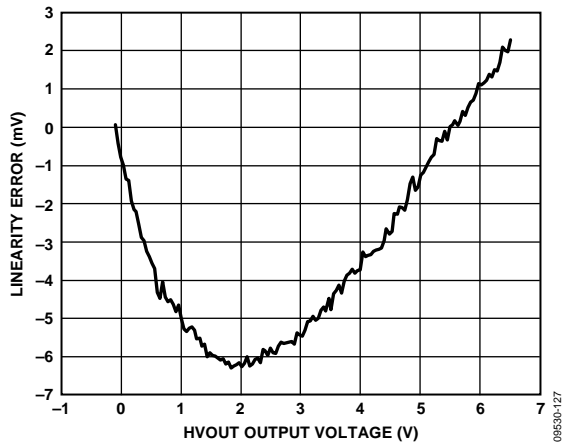

Figure 34. HVOUT VIH Linearity Error

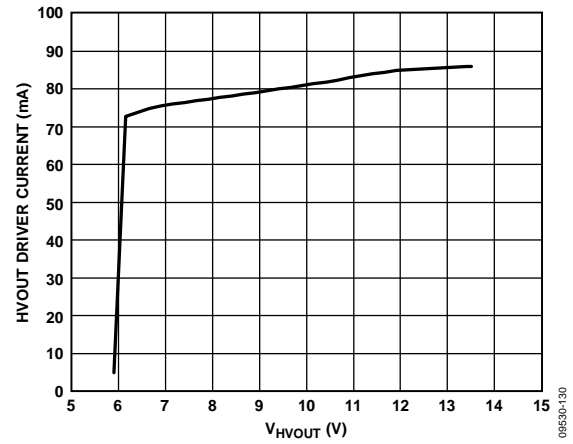

Figure 37. HVOUT VHH Output Current Limit; VHH = 5.9 V, HVOUT Swept 5.9 V to 13.5 V

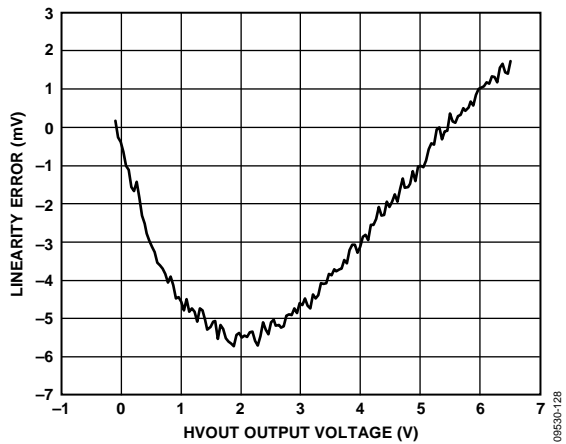

Figure 35. HVOUT VIL Linearity Error

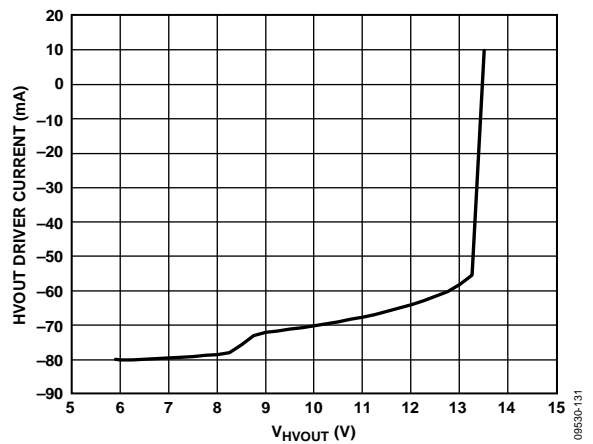

Figure 38. HVOUT VHH Output Current Limit; VHH = 13.5 V, HVOUT Swept 5.9 V to 13.5 V

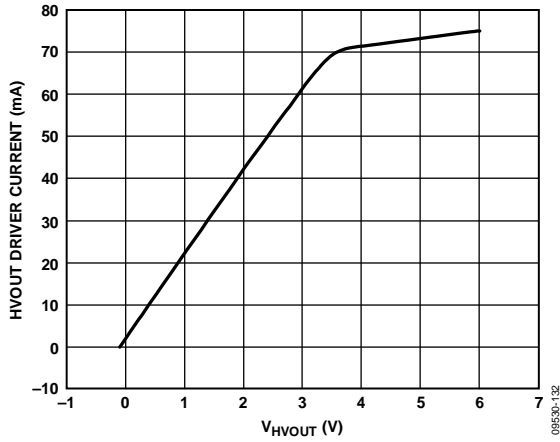

Figure 39. HVOUT VIL Output Current Limit; VIL = -0.1 V, HVOUT Swept -0.1 V to 6.0 V

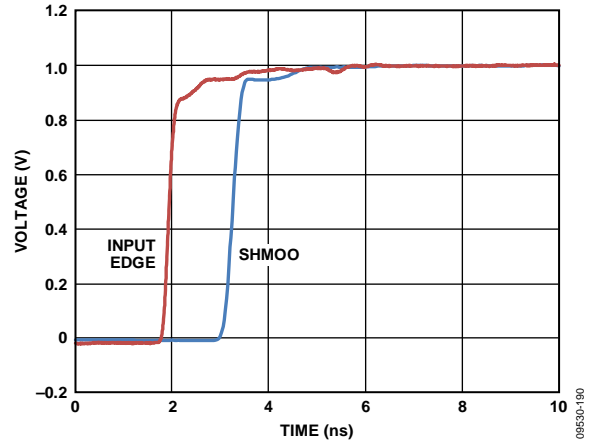

Figure 42. Normal Window Comparator Shmoo; 1.0 V Swing, 50 Ω Termination, 200 ps (20% to 80%)

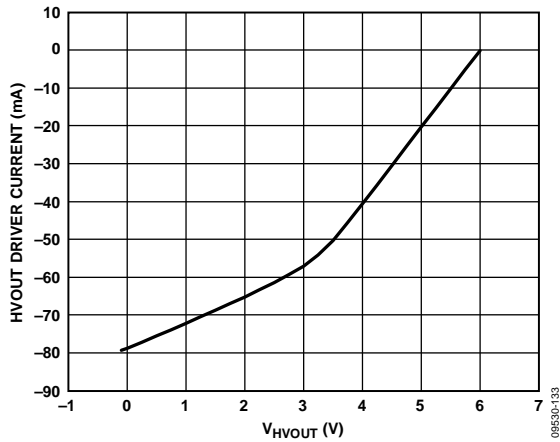

Figure 40. HVOUT VIH Output Current Limit; VIH = 6.0 V, HVOUT Swept -0.1 V to 6.0 V

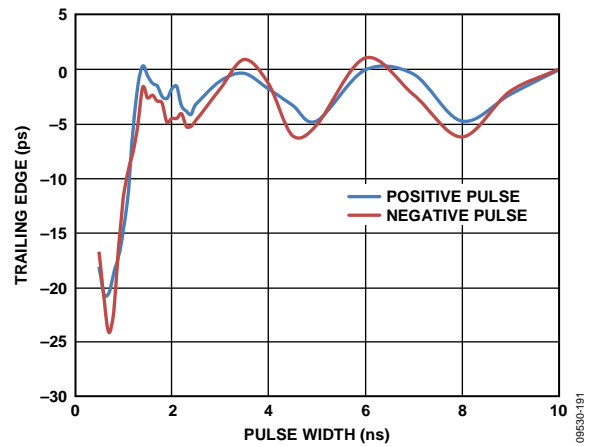

Figure 43. Normal Window Comparator Trailing Edge Timing Error vs. Input Pulse Width; 50 Ω Termination, 1.0 V Swing, 200 ps (20% to 80%)

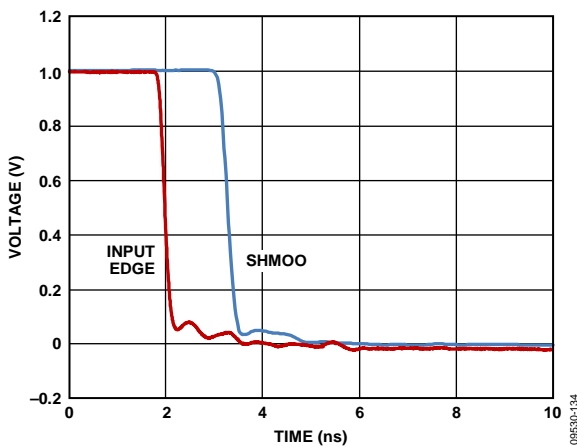

Figure 41. Normal Window Comparator Shmoo 1.0 V Swing; 50 Ω Termination, 200 ps (20% to 80%)

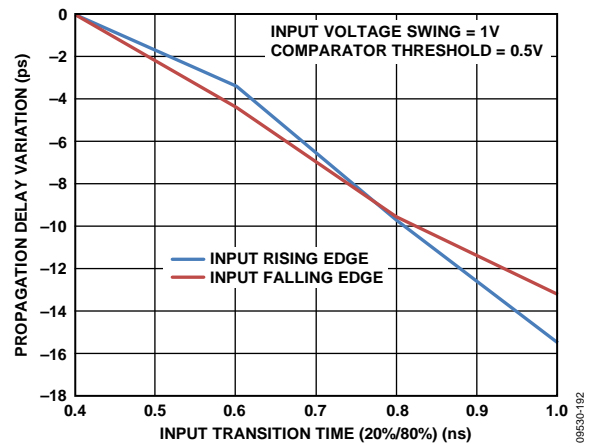

Figure 44. Normal Window Comparator Input Transition Time (20%/80%), 50 Ω Termination

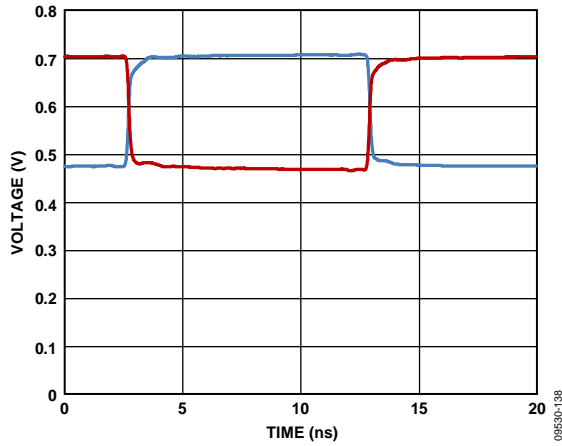

Figure 45. Comparator Output Waveform

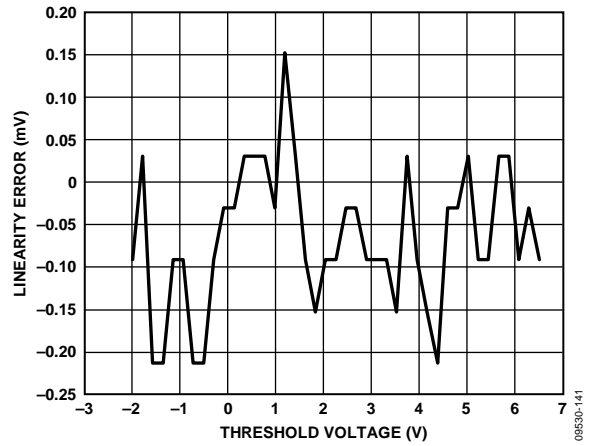

Figure 48. PPMU Go/No-Go Comparator Linearity Error

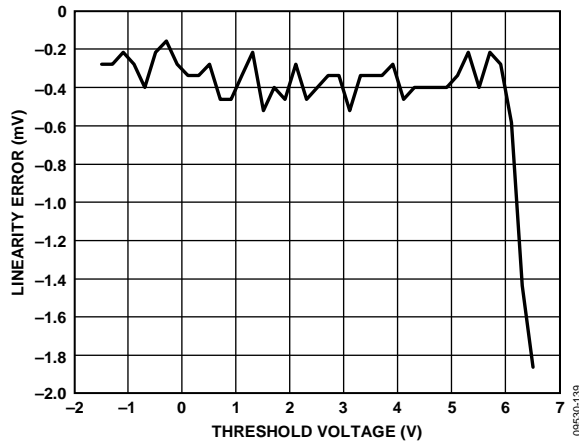

Figure 46. Normal Window Comparator Threshold Linearity Error

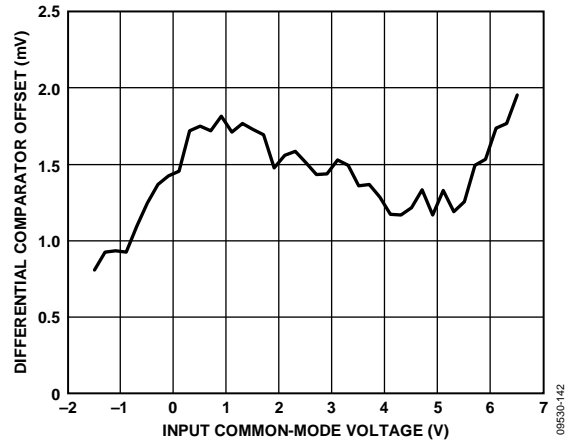

Figure 49. Differential Comparator CMR Error

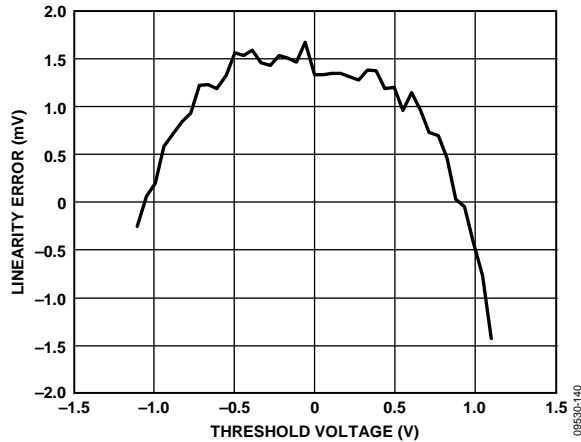

Figure 47. Differential Comparator Threshold Linearity Error

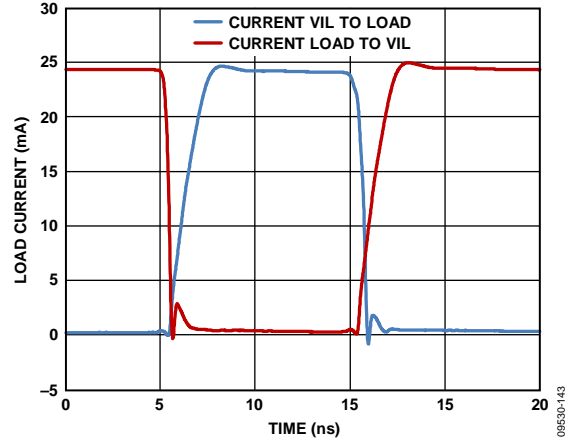

Figure 50. Active Load Response to/from Drive $V_{IL} = 0\text{ V}$, $50\ \Omega$ Termination, $I_{OL} = 25\text{ mA}$, $V_{COM} = 2\text{ V}$

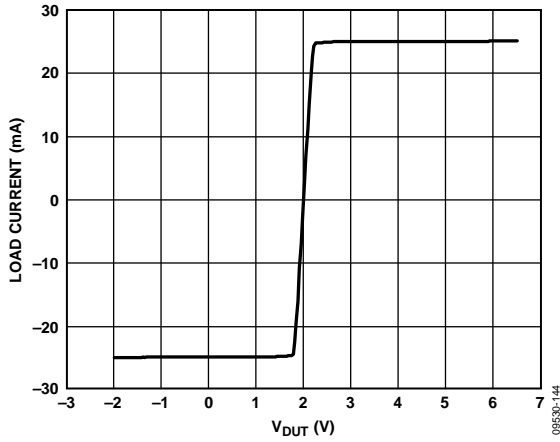

Figure 51. Active Load Commutation Response, $V_{COM} = 2.0\text{ V}$, $I_{OH} = I_{OL} = 25\text{ mA}$

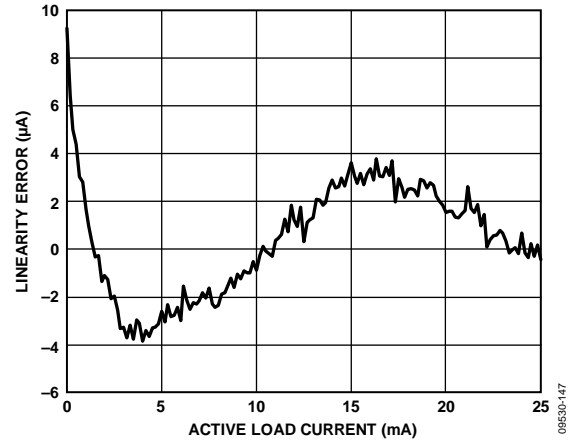

Figure 54. Active Load IOL Linearity Error

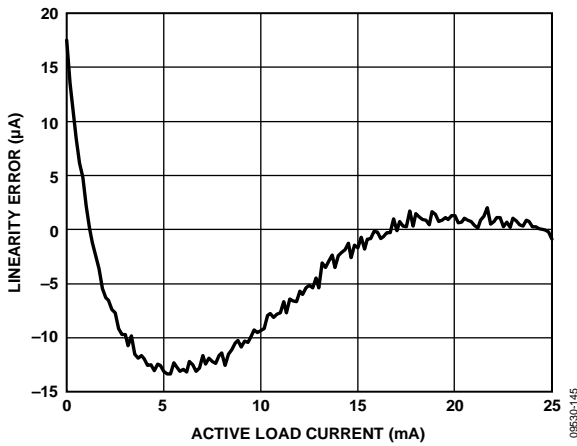

Figure 52. Active Load IOH Linearity Error

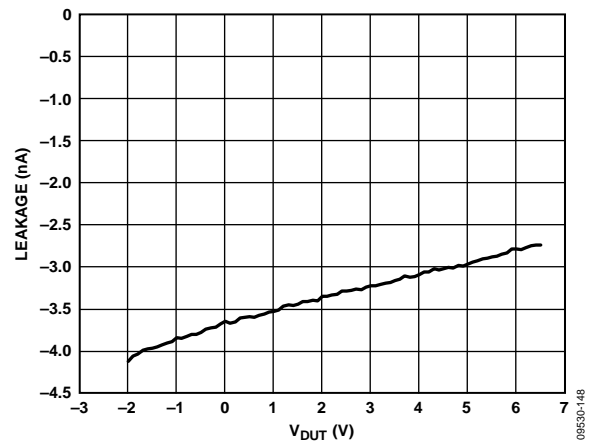

Figure 55. DUTx Pin Leakage in Low Leakage Mode

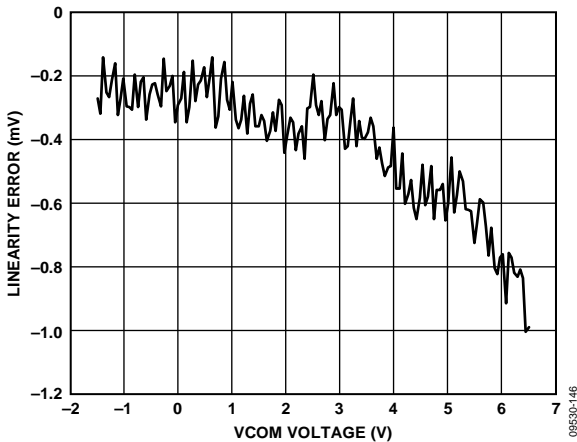

Figure 53. Active Load V_{COM} Linearity Error

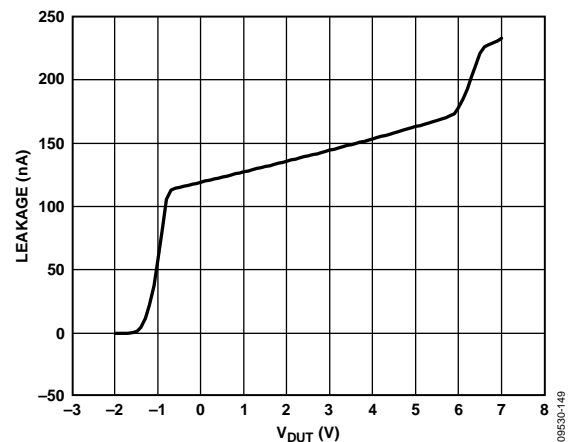

Figure 56. DUTx Pin Leakage in High-Z Mode

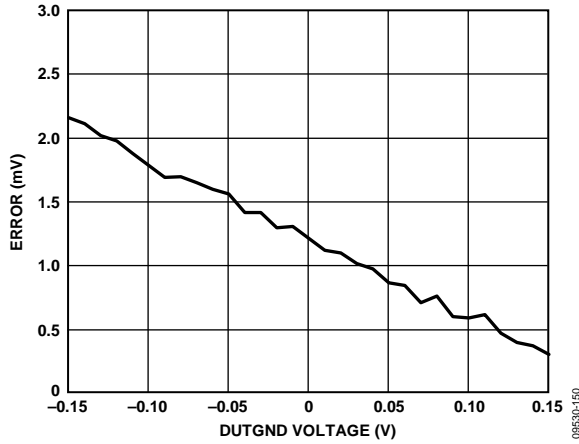

Figure 57. Typical DUTGND Transfer Function Voltage Error, Drive Low VIL = 0 V

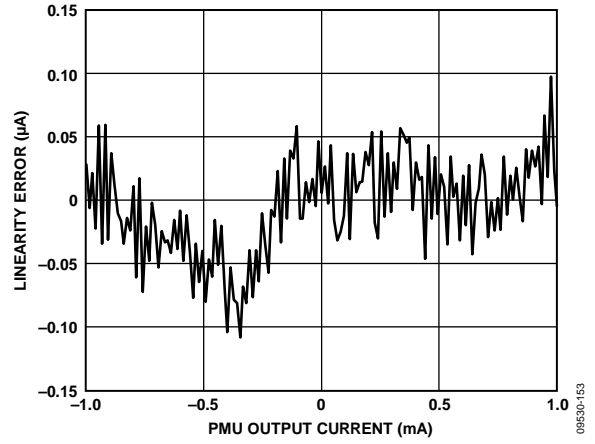

Figure 60. PPMU Range B Force Current Linearity Error

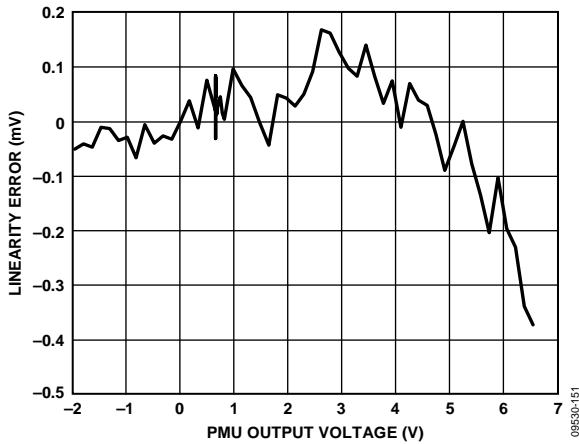

Figure 58. PPMU Force Voltage Linearity Error, All Ranges

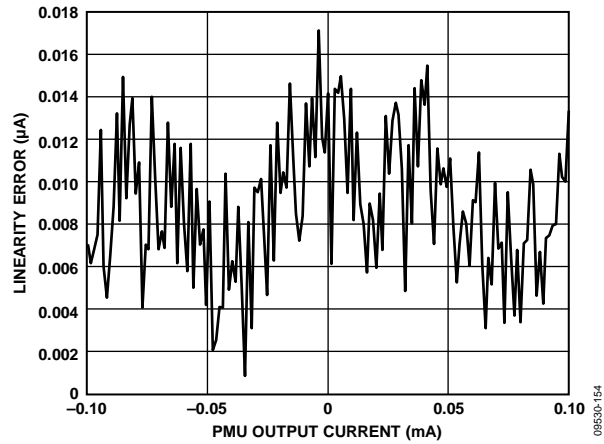

Figure 61. PPMU Range C Force Current Linearity Error

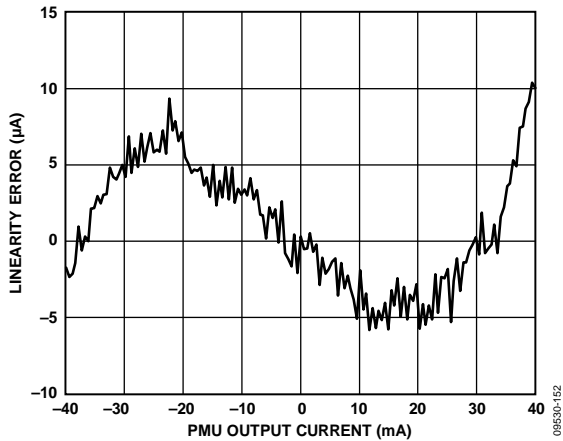

Figure 59. PPMU Range A Force Current Linearity Error

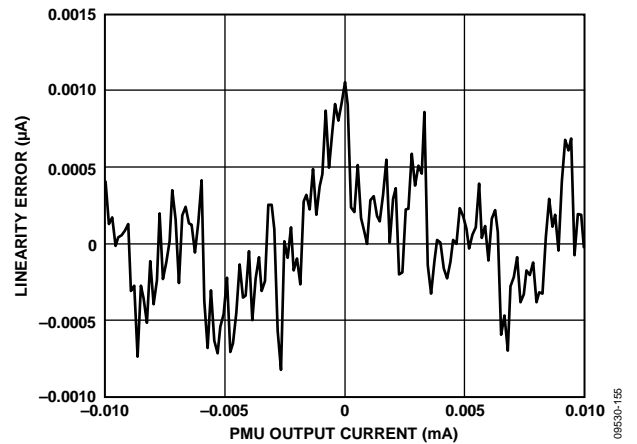

Figure 62. PPMU Range D Force Current Linearity Error

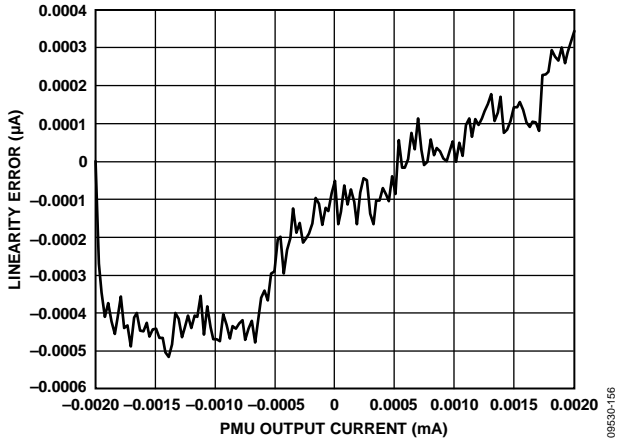

Figure 63. PPMU Range E Force Current Linearity Error

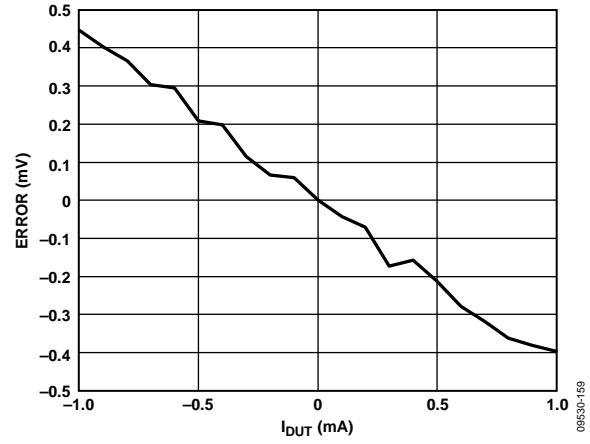

Figure 66. PPMU Force Voltage Range B Compliance Error at -2.0 V vs. Output Current, Internal Sense

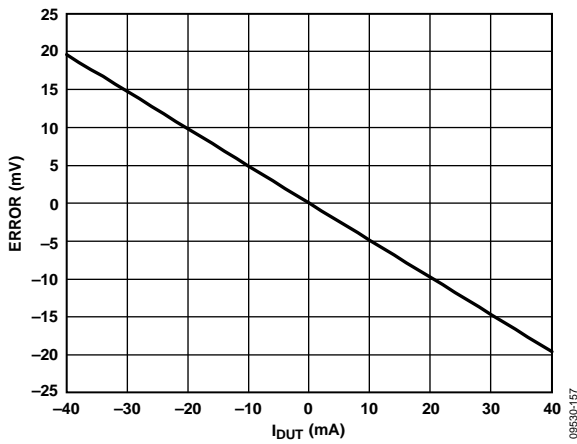

Figure 64. PPMU Force Voltage Range A Compliance Error at -2.0 V vs. Output Current, Internal Sense

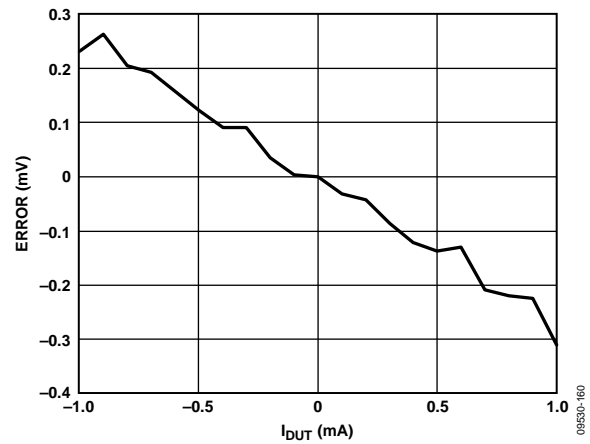

Figure 67. PPMU Force Voltage Range B Compliance Error at +6.5 V vs. Output Current, Internal Sense

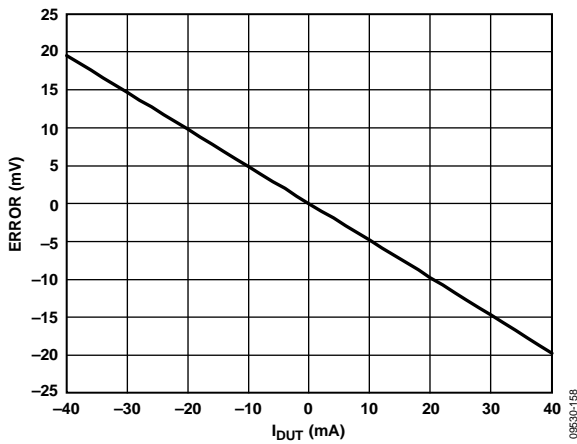

Figure 65. PPMU Force Voltage Range A Compliance Error at +5.75 V vs. Output Current, Internal Sense

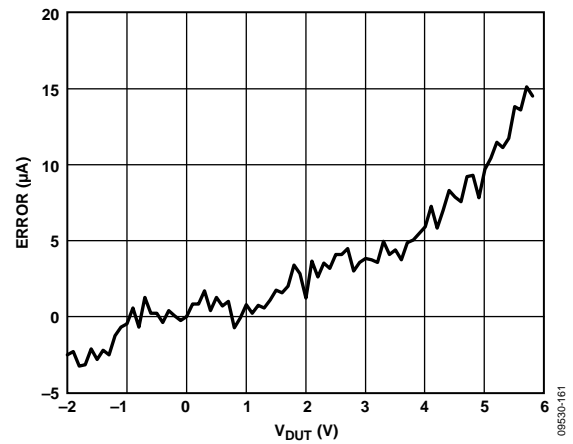

Figure 68. PPMU Force Current Range A Compliance Error at -40 mA vs. Output Voltage

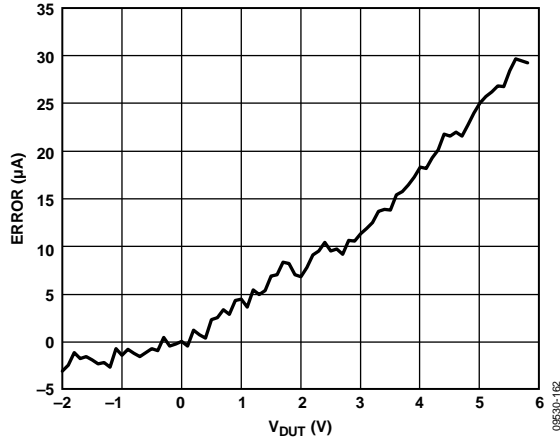

Figure 69. PPMU Force Current Range A Compliance Error at +40 mA vs. Output Voltage

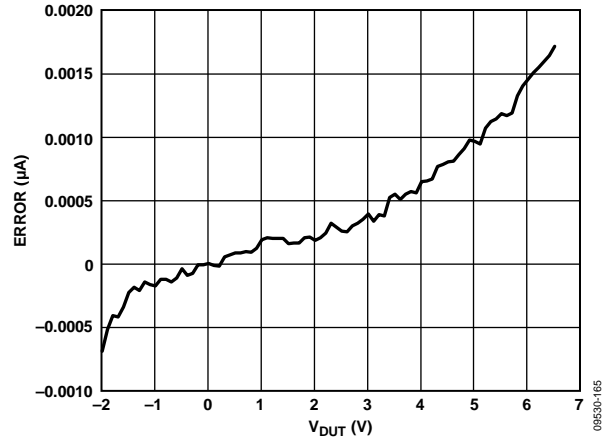

Figure 72. PPMU Force Current Range E Compliance Error at -2 µA vs. Output Voltage

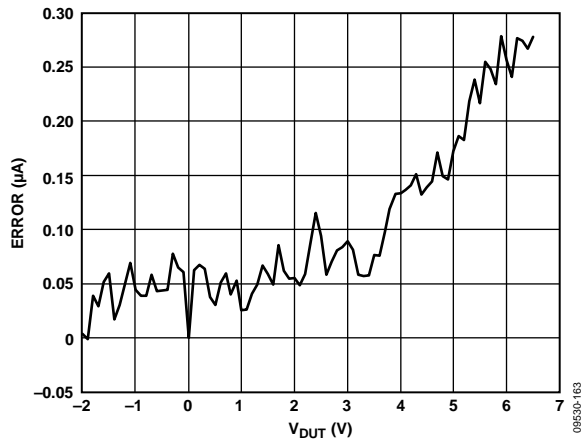

Figure 70. PPMU Force Current Range B Compliance Error at -1 mA vs. Output Voltage

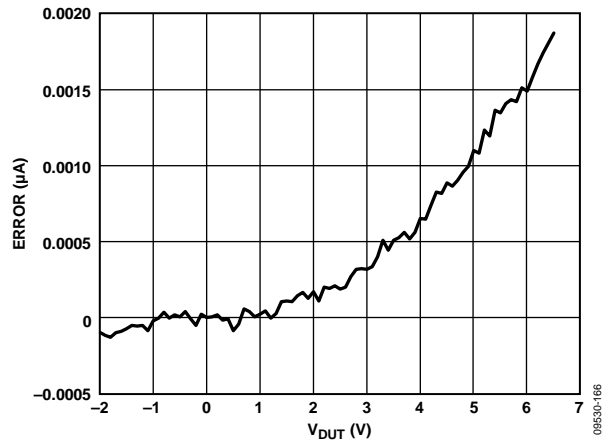

Figure 73. PPMU Force Current Range E Compliance Error at +2 µA vs. Output Voltage

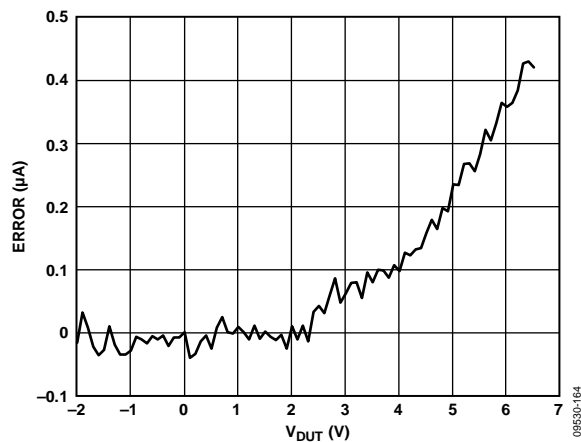

Figure 71. PPMU Force Current Range B Compliance Error at +1 mA vs. Output Voltage

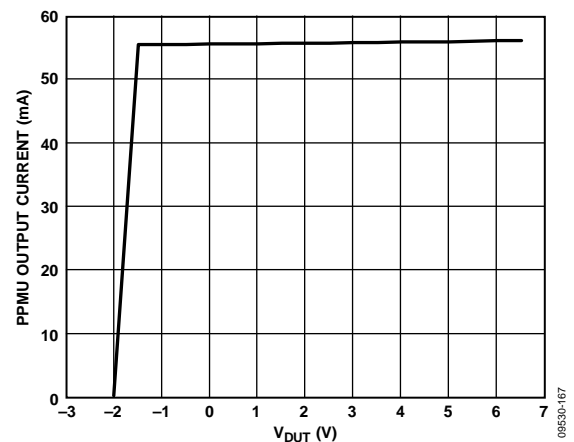

Figure 74. PPMU Force Voltage Output Current Limit Range A, FV = -2.0 V, V_{DUT} Swept -2.0 V to +6.5 V

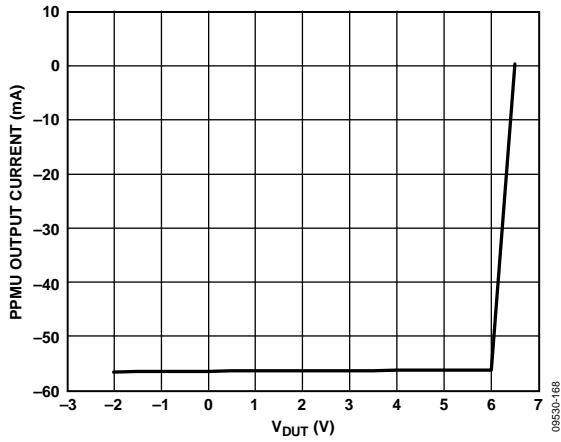

Figure 75. PPMU Force Voltage Output Current Limit Range A, $FV = +6.5 V$, V_{DUT} Swept $-2.0 V$ to $+6.5 V$

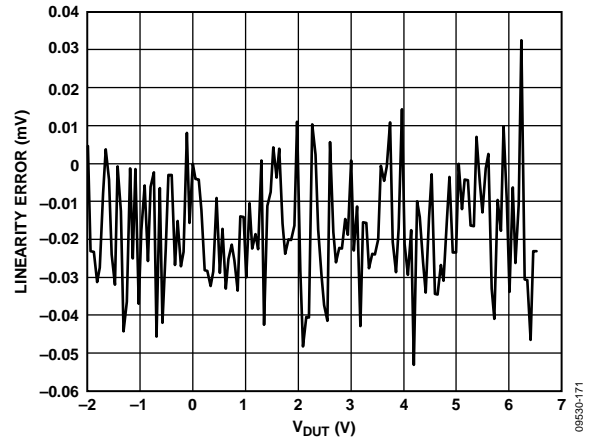

Figure 78. PPMU Range B Measure Voltage Linearity Error

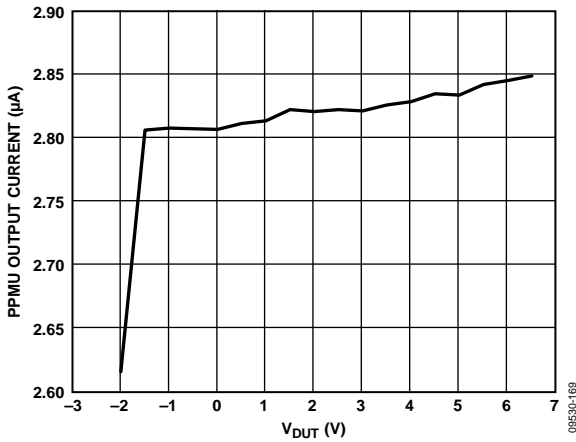

Figure 76. PPMU Force Voltage Output Current Limit Range E, $FV = -2.0 V$, V_{DUT} Swept $-2.0 V$ to $+6.5 V$

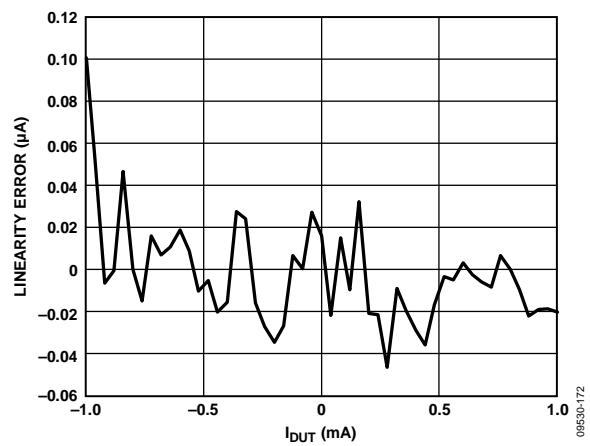

Figure 79. PPMU Range B Measure Current Linearity Error

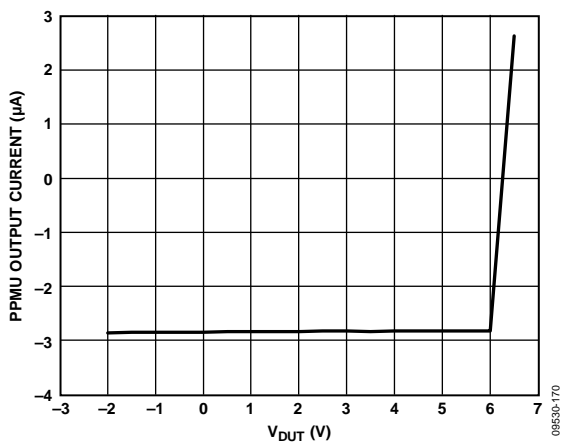

Figure 77. PPMU Force Voltage Output Current Limit Range E, $FV = 6.5 V$, V_{DUT} Swept $-2.0 V$ to $+6.5 V$

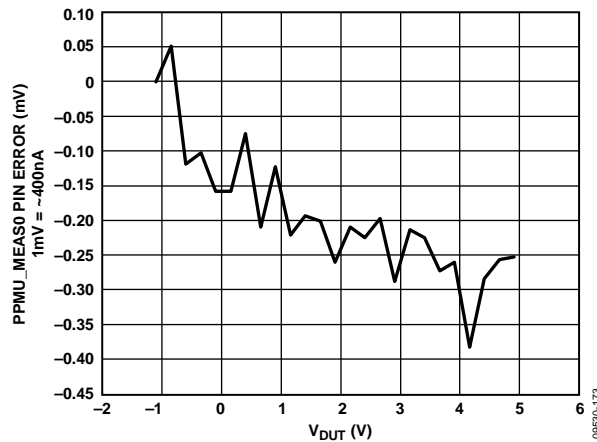

Figure 80. PPMU Measure Current CMR Error, (FVMI), Sourcing $0.5 mA$

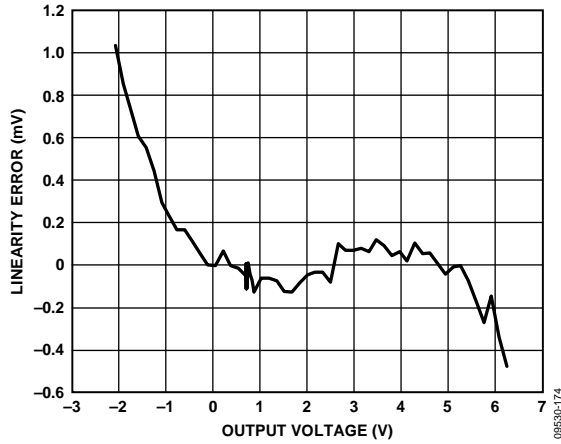

Figure 81. Reflection Clamp VCL Linearity Error

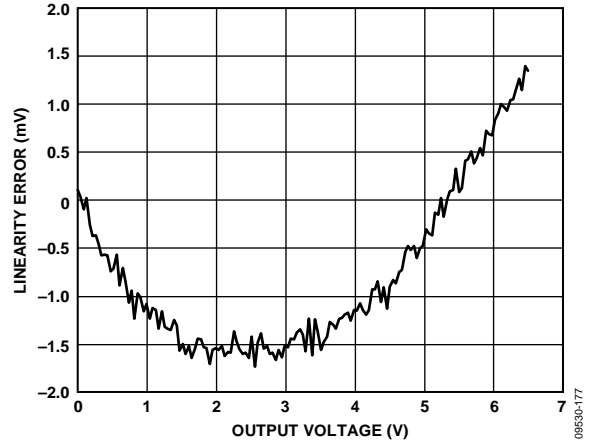

Figure 84. PPMU Voltage Clamp VCH Linearity Error

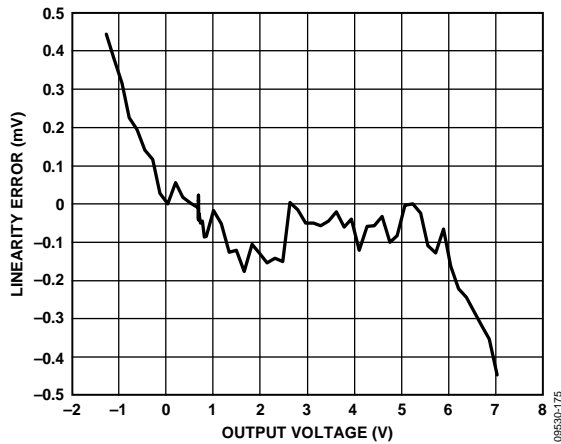

Figure 82. Reflection Clamp VCH Linearity Error

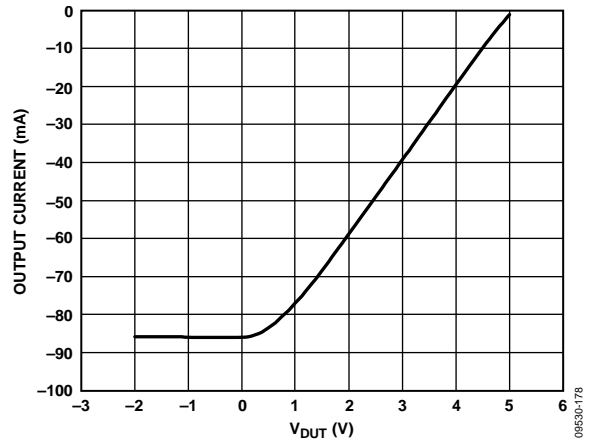

Figure 85. VCL Reflection Clamp Current Limit; VCH = 6 V, VCL = 5 V, VDUT Swept -2.0 V to +5.0 V

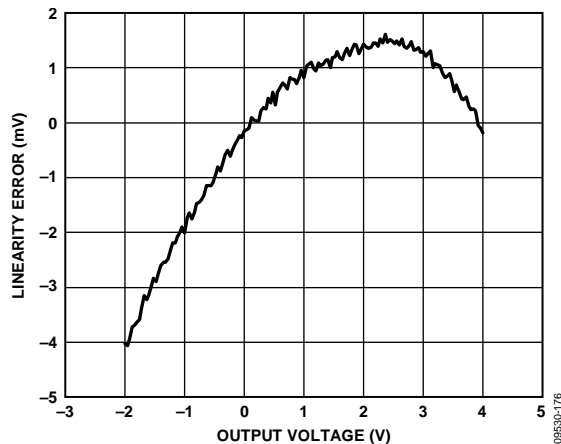

Figure 83. PPMU Voltage Clamp VCL Linearity Error

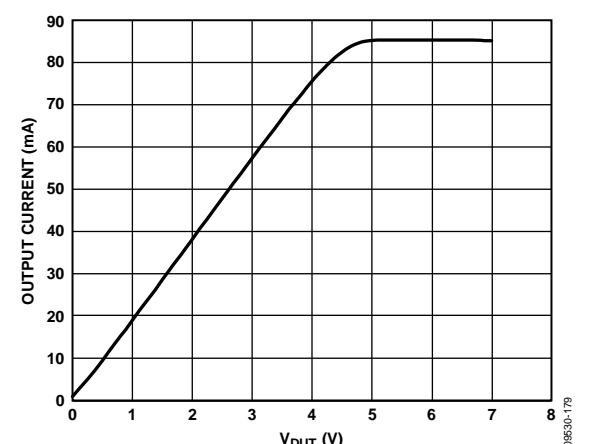

Figure 86. VCH Reflection Clamp Current Limit; VCH = 0 V, VCL = -2 V, VDUT Swept -2.0 V to +5.0 V

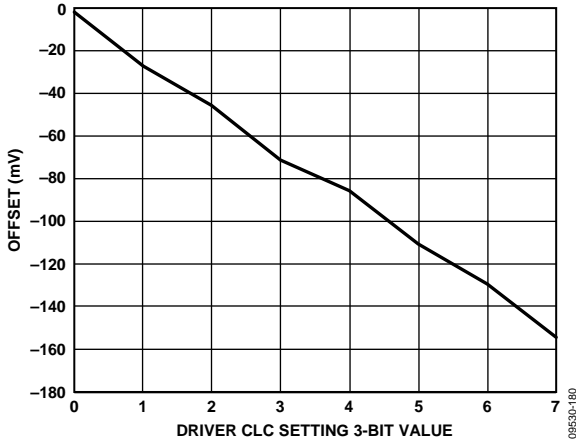

Figure 87. Driver Offset Error vs. Driver CLC Setting

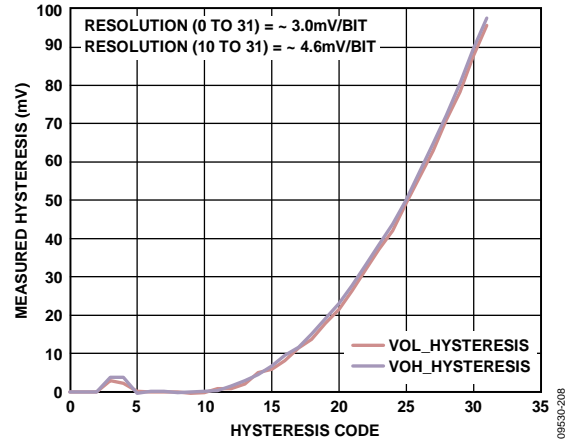

Figure 90. Normal Window Comparator Hysteresis Transfer Function

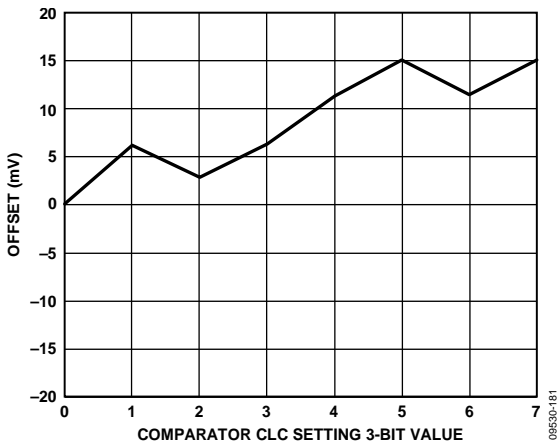

Figure 88. Normal Window Comparator Offset Error vs. CLC Setting

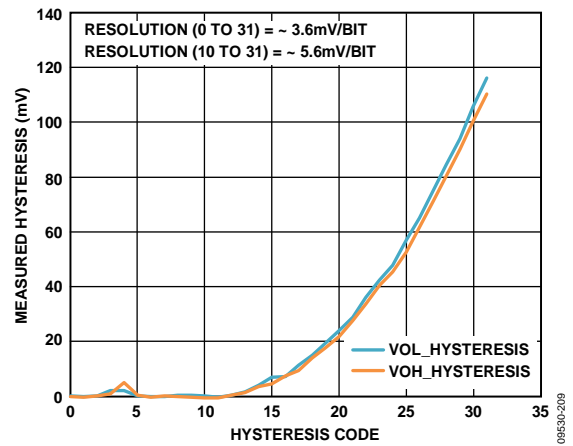

Figure 91. Differential Comparator Hysteresis Transfer Function

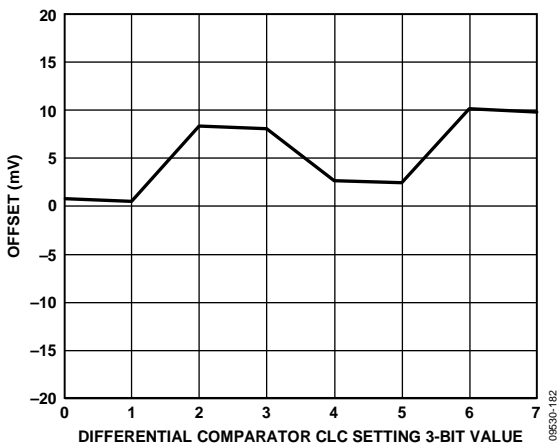

Figure 89. Differential Comparator Offset error vs. CLC Setting

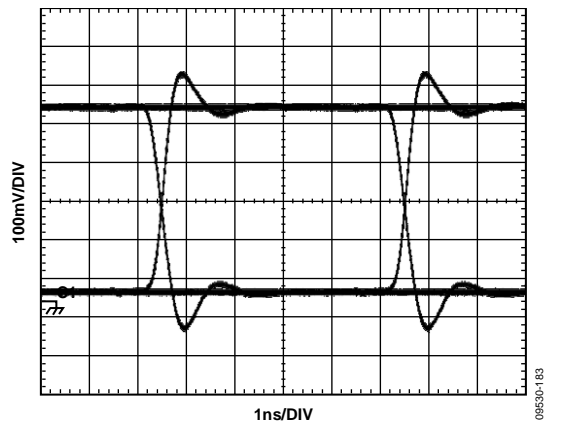

Figure 92. Driver Eye Diagram, 400 Mbps, PRBS31; $V_{IH} = 1\text{ V}$, $V_{IL} = 0\text{ V}$

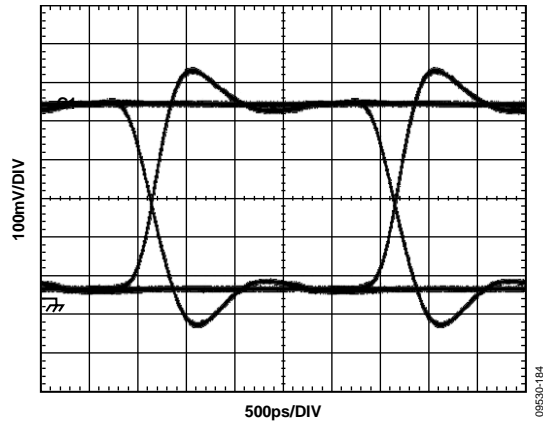

Figure 93. Driver Eye Diagram, 800 Mbps, PRBS31; $V_{IH} = 1\text{ V}$, $V_{IL} = 0\text{ V}$

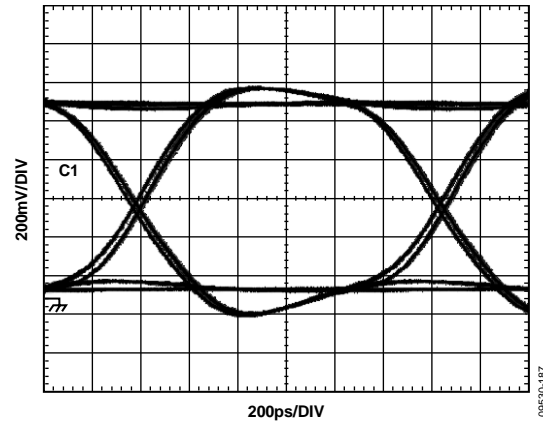

Figure 96. Driver Eye Diagram, 1600 Mbps, PRBS31; $V_{IH} = 2\text{ V}$, $V_{IL} = 0\text{ V}$

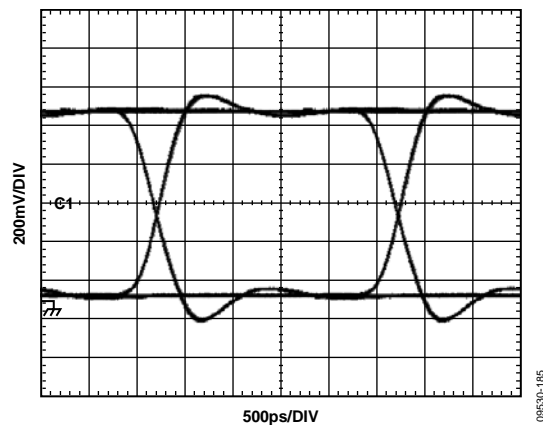

Figure 94. Driver Eye Diagram, 800 Mbps, PRBS31; $V_{IH} = 2\text{ V}$, $V_{IL} = 0\text{ V}$

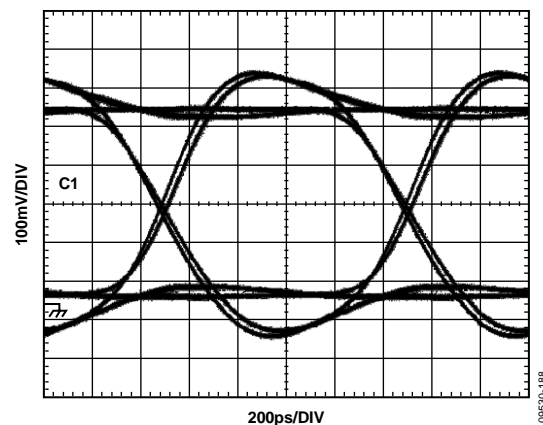

Figure 97. Driver Eye Diagram, 2000 Mbps, PRBS31; $V_{IH} = 1\text{ V}$, $V_{IL} = 0\text{ V}$

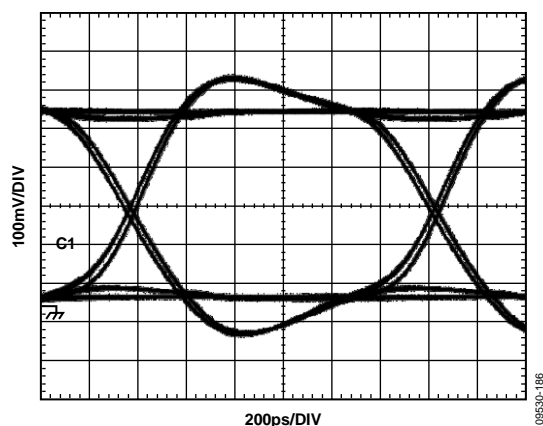

Figure 95. Driver Eye Diagram, 1600 Mbps, PRBS31; $V_{IH} = 1\text{ V}$, $V_{IL} = 0\text{ V}$

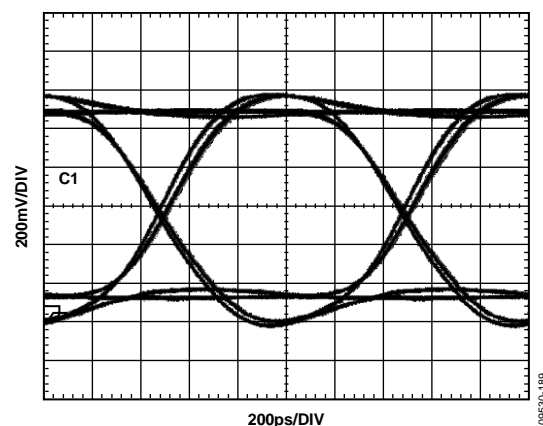

Figure 98. Driver Eye Diagram, 2000 Mbps, PRBS31; $V_{IH} = 2\text{ V}$, $V_{IL} = 0\text{ V}$

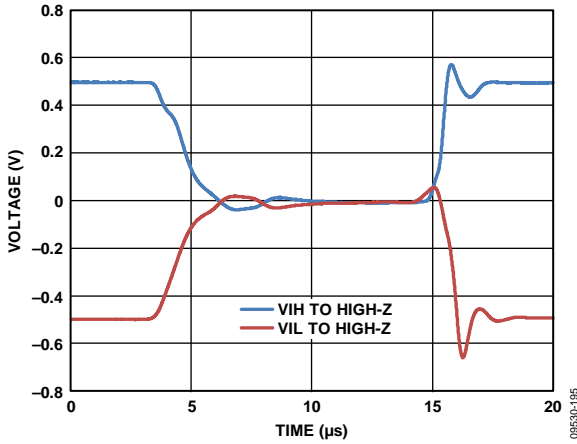

Figure 99. Drive to/from High-Z Transition, $V_{IH} = 1\text{ V}$, $V_{IL} = -1\text{ V}$, $50\ \Omega$ Termination

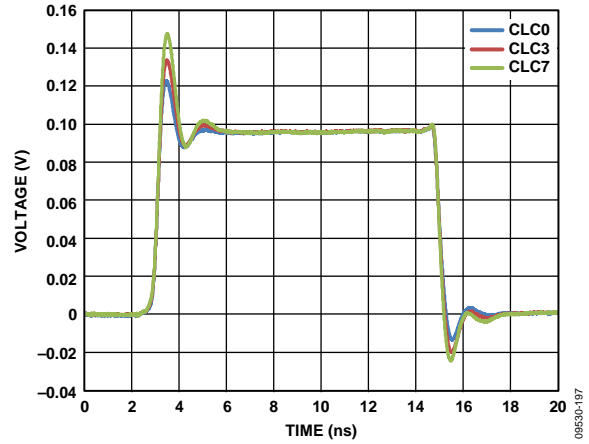

Figure 102. Driver 0.2 V Response vs. CLC Settings

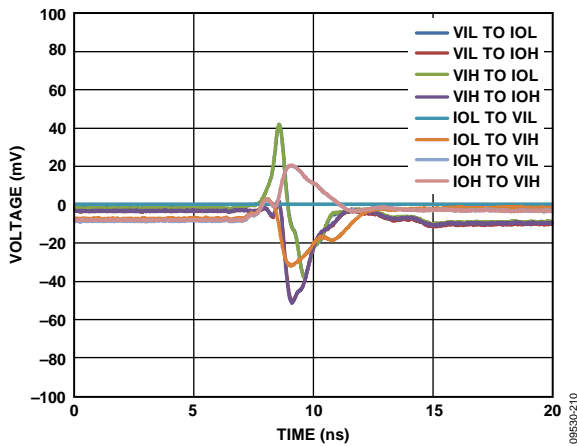

Figure 100. Drive to/from Active Load Transient, $V_{IL} = V_{IH} = 0\text{ V}$, $I_{OH} = I_{OL} = 0\text{ V}$

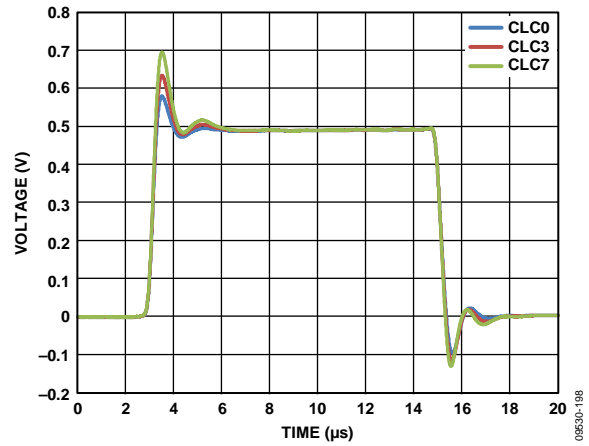

Figure 103. Driver 1 V Response vs. CLC Settings

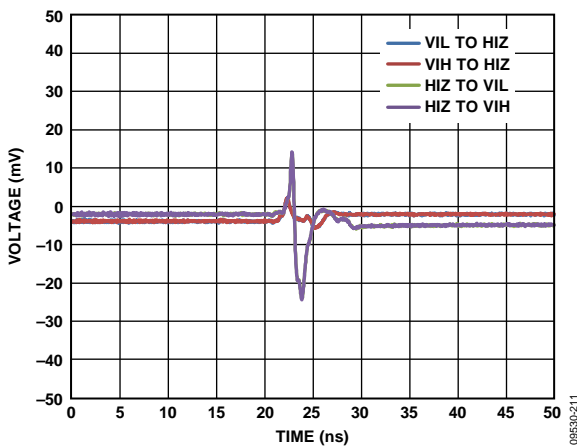

Figure 101. Drive to/from High-Z Transient, $V_{IL} = V_{IH} = 0\text{ V}$, $50\ \Omega$ Termination

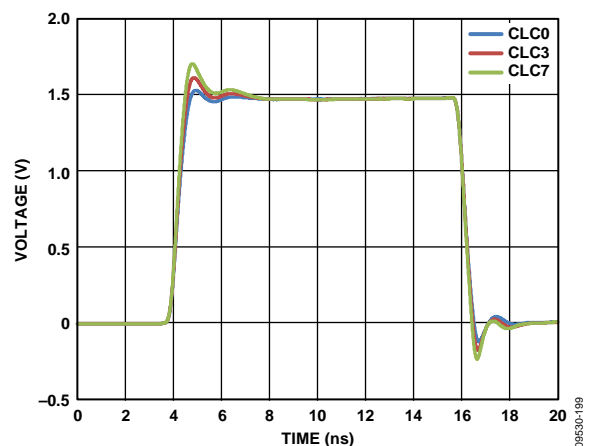

Figure 104. Driver 3 V Response vs. CLC Settings

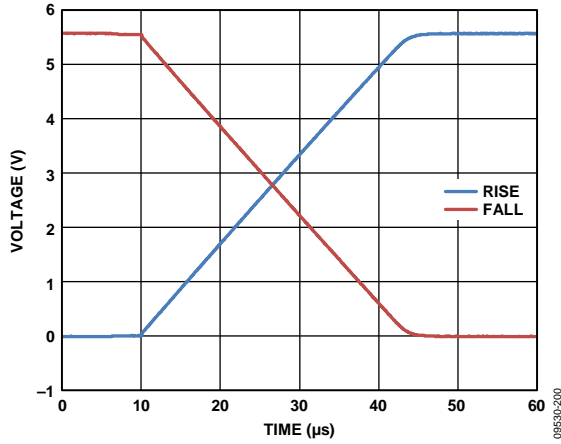

Figure 105. PPMU Transient Response, FI Range A, Full-Scale Transition, Uncalibrated, $C_{LOAD} = 200 \text{ pF}$, $R_{LOAD} = 120 \Omega$

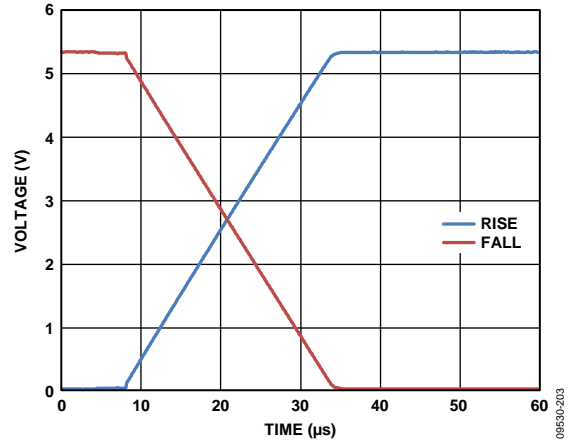

Figure 108. PPMU Transient Response, FV Range A, 0 V to 5 V, Uncalibrated, $C_{LOAD} = 200 \text{ pF}$

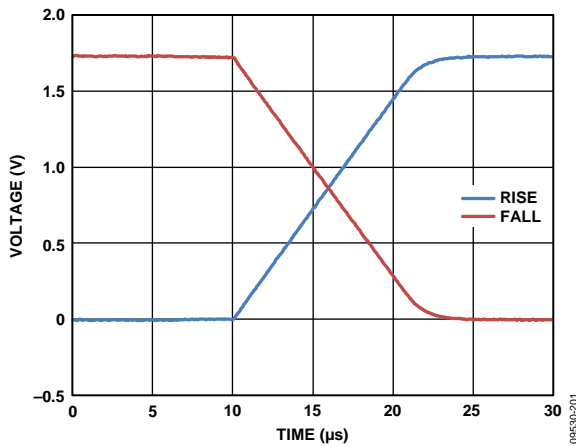

Figure 106. PPMU Transient Response, FI Range B, Full-Scale Transition, Uncalibrated, $C_{LOAD} = 200 \text{ pF}$, $R_{LOAD} = 1.5 \text{ k}\Omega$

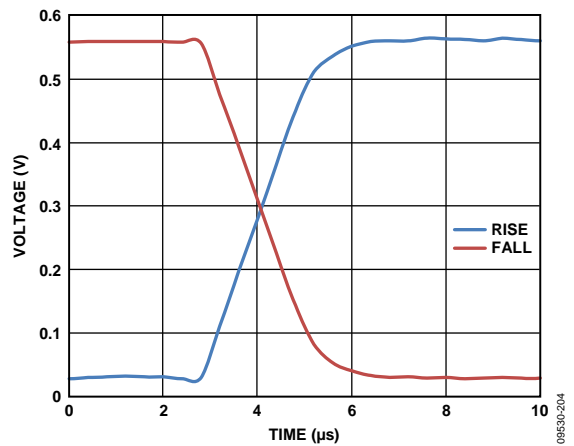

Figure 109. PPMU Transient Response, FV Range A, 0 V to 0.5 V, Uncalibrated, $C_{LOAD} = 200 \text{ pF}$

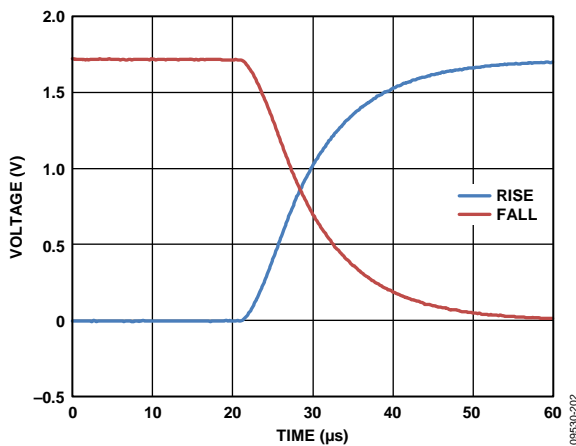

Figure 107. PPMU Transient Response, FI Range C, Full-Scale Transition, Uncalibrated, $C_{LOAD} = 200 \text{ pF}$, $R_{LOAD} = 15 \text{ k}\Omega$

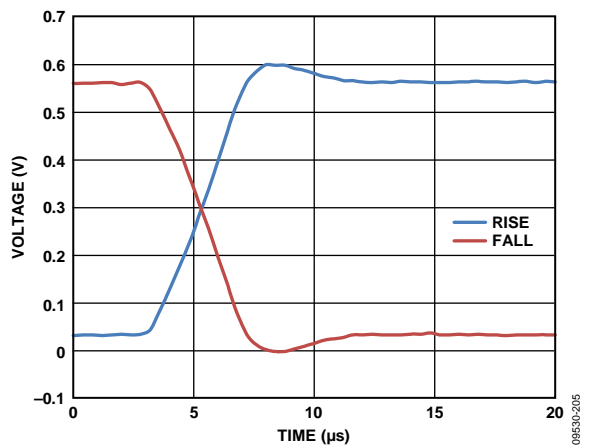

Figure 110. PPMU Transient Response, FV Range C, 0 V to 0.5 V, Uncalibrated, $C_{LOAD} = 200 \text{ pF}$

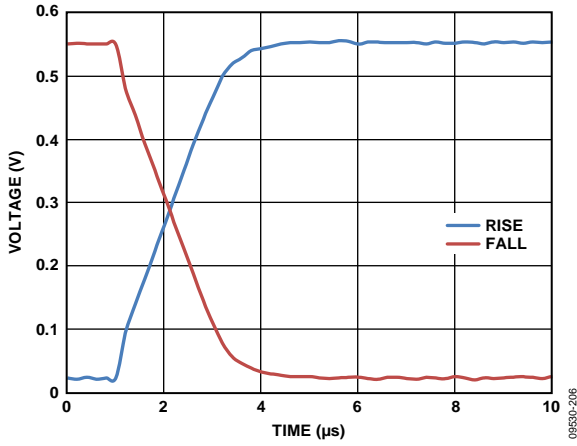

Figure 111. PPMU Transient Response, FV Range A, 0 V to 0.5 V, Uncalibrated, $C_{LOAD} = 2000\text{ pF}$

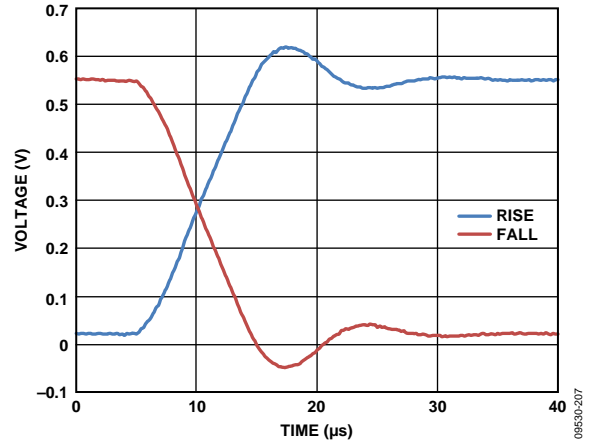
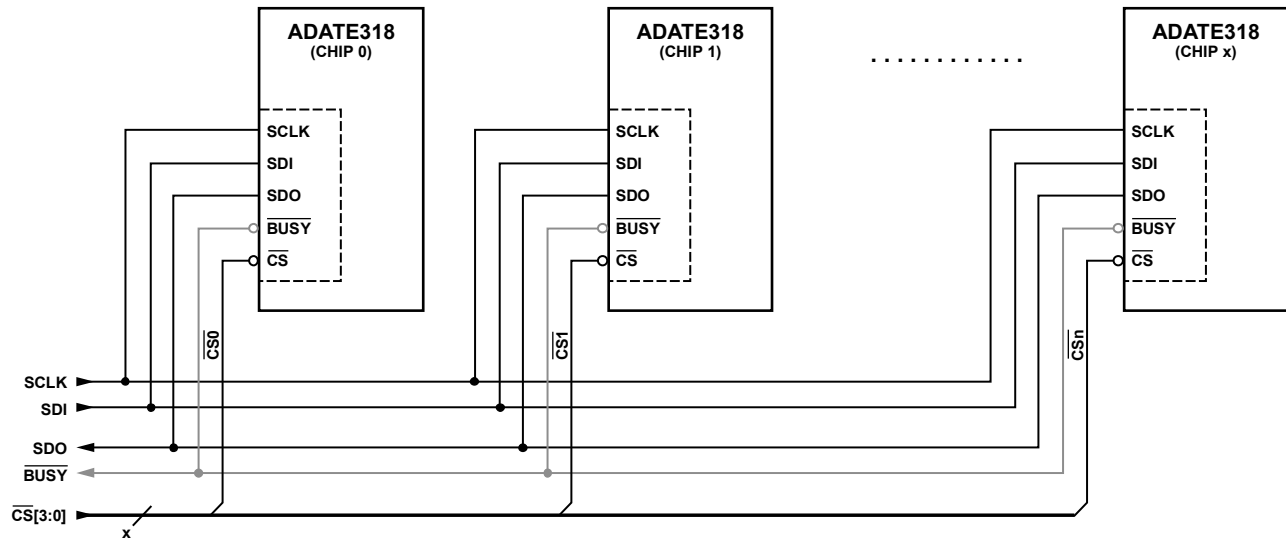

Figure 112. PPMU Transient Response, FV Range C, 0 V to 0.5 V, Uncalibrated, $C_{LOAD} = 2000\text{ pF}$

SPI INTERCONNECT DETAILS



NOTES
1. $x \leq 4$.

Figure 113. Multiple SPI with Shared SDO Line

095530-003

USE OF THE SPI $\overline{\text{BUSY}}$ PIN

After any valid SPI instruction is written to the ADATE318, the $\overline{\text{BUSY}}$ pin becomes asserted to indicate a busy status of the DAC update and calibration engines. The $\overline{\text{BUSY}}$ pin is an open drain type output capable of sinking a minimum of 5 mA from the VCC supply. Because it is an open drain type output, it can be wire-or'ed in common with many other similar open drain devices. In such cases, it is the user's responsibility either to determine which device is indicating the busy state or, alternatively, to wait until all devices on the shared line become not busy. It is recommended that the $\overline{\text{BUSY}}$ pin be tied to VCC with an external 1 k Ω pull-up.

It is not a requirement to wait for release of $\overline{\text{BUSY}}$ prior to a subsequent assertion of the $\overline{\text{CS}}$ pin. This is not the purpose of the $\overline{\text{BUSY}}$ pin. As long as the minimum number of SCLK cycles following the previous release of $\overline{\text{CS}}$ is met according to the t_{CSAM} parameter, the $\overline{\text{CS}}$ pin can be asserted again for a subsequent SPI operation. With the one exception of recovery from a reset request (either by hardware assertion of the $\overline{\text{RST}}$ pin or a software setting of the internal SPI_RESET control bit), there is no scenario in normal operation of the ADATE318 in which the user must wait for release of $\overline{\text{BUSY}}$ prior to asserting the $\overline{\text{CS}}$ for another SPI operation. The only requirement on the assertion of $\overline{\text{CS}}$ is that the t_{CSAM} parameter be defined as in Figure 4 and Table 13.

It is very important, however, that the SCLK continue to operate for as long as the $\overline{\text{BUSY}}$ pin state remains active. This minimum period of time is defined by the t_{BUSW} parameter (see Figure 4, Figure 6, Figure 7, and Table 18). If the SCLK does not remain active for at least the time specified by the t_{BUSW} parameter, operations pending to the internal processor may not fully complete or, worse, they may complete in an incorrect fashion. In either case, a temporary malfunction of the ADATE318 may occur.

After the ADATE318 releases the $\overline{\text{BUSY}}$ pin, the SCLK may again be stopped to prevent unwanted digital noise from coupling into the analog levels during normal operation of the

pin electronics functions. In every case (with no exception for reset recovery), it is the purpose of the $\overline{\text{BUSY}}$ pin to notify the external test processor that it is again safe to stop the SCLK signal to the ADATE318. Running the SCLK for extra periods when $\overline{\text{BUSY}}$ is not active is never a problem except for the possibility of adding unwanted digital switching noise to the analog pin electronics circuitry as already noted.

While the length of the $\overline{\text{BUSY}}$ period (t_{BUSW}) is variable depending on the particular preceding SPI instruction, it is nevertheless deterministic. The parameter t_{BUSW} depends only on factors such as whether the previous instruction involved a write to one or more DAC addresses and, if so, then how many channels were involved and whether or not the calibration function was enabled. Table 18 describes the precise length of the t_{BUSW} period in units of rising edge SCLK cycles for each possible SPI instruction scenario as well as recovery from a hard $\overline{\text{RST}}$ reset.

Because t_{BUSW} is deterministic, it is therefore possible to predict in advance the minimum number of rising edge SCLK cycles required to complete any given SPI instruction. This makes it possible to operate the ADATE318 without a need to monitor the state of the $\overline{\text{BUSY}}$ pin. For applications in which it is neither possible nor desirable to monitor the pin, it is acceptable to use the information in Table 18 to guarantee that the minimum number of cycles is provided in lieu of monitoring $\overline{\text{BUSY}}$ following release of $\overline{\text{CS}}$ or reset. All DAC addresses have been assigned to the contiguous address block from 0x00 through 0x0F; therefore, it is possible to decode this information within the external test processor to provide a software indication that extra SCLK cycles may be required according to the scenarios listed in Table 18. All other operations not involving these addresses require only the standard number of clock cycles determined by t_{CSAM} . As stated above, however, it is extremely important to honor the minimum number of required rising edge SCLK cycles as defined by t_{BUSW} following the release of $\overline{\text{CS}}$ for each of the SPI instruction scenarios listed in Table 18 to ensure proper operation of the ADATE318.

Table 18. $\overline{\text{BUSY}}$ Minimum SCLK Cycle Requirements

SPI Instruction Type	Calibration Engine ¹	Maximum t_{BUSW} (SCLK Cycles)
Following the Release of the Asynchronous Reset Pin (Hardware Reset)	X	64
Following Assertion of the SPI_RESET Control Bit (Software Reset)	X	64
No Operation (NOP) Instruction	X	3
Read Request to Any Valid ADATE318 Address and/or Channel (0x00 – 0x7F)	X	3
Single/Double Channel Write Request to Any Valid ADATE318 Address \geq 0x10	X	3
Single Channel Write Request to Any DAC (ADDR 0x01 – ADDR 0x0E)	Disabled	10
Double Channel Write Request to Any DAC (ADDR 0x01 – ADDR 0x0E)	Disabled	16
Single Channel Write Request to Any DAC (ADDR 0x01 – ADDR 0x0E)	Enabled	20
Double Channel Write Request to Any DAC (ADDR 0x01 – ADDR 0x0E)	Enabled	26

¹ X = don't care.

RESET SEQUENCE AND THE $\overline{\text{RST}}$ PIN

The internal state of the ADATE318 is indeterminate following power-up. For this reason, it is necessary to perform a complete reset sequence once the power supplies have stabilized. Further, the $\overline{\text{RST}}$ pin must be held in the asserted state before and during the power-up sequence and released only after all power supplies are known to be stable.

The ADATE318 has an active low pin ($\overline{\text{RST}}$) that asynchronously starts a reset sequence. A soft reset sequence can also be initiated under SPI software control by writing to the SPI_RESET bit in the SPI Control Register (SPI 0x12[0] (see Figure 13)). In the case of a soft reset, the sequence begins on the first rising edge of SCLK following the release of $\overline{\text{CS}}$, subject to the normal setup and hold times. Certain actions take place immediately upon initiation of the reset request, whereas other actions require SCLK.

The following asynchronous actions take place as soon as a reset request is detected, whether or not SCLK is active:

- Assert $\overline{\text{BUSY}}$ pin
- Force all control registers to the default reset state as defined by control register definitions
- Clear all calibration registers to the default reset state as defined by calibration register definitions
- Override all DAC output voltages and force analog levels to V_{DUTGND}
- Disable DCLs and PPMUs; open system PMU switches
- Soft connect the DUT0 and DUT1 pins to V_{DUTGND} (see Figure 114)

The part remains in this static reset state indefinitely until the clocked portion of the sequence begins with either the first rising edge of SCLK following the release of $\overline{\text{RST}}$ (asynchronous reset) or the second rising edge of SCLK following the release of $\overline{\text{CS}}$ (soft reset). No matter how the reset sequence is initiated, the clocked portion of the reset sequence requires 64 SCLK cycles to run to completion, and the $\overline{\text{BUSY}}$ pin remains asserted until these clock cycles have been received. The following actions take place during the clocked portion of the reset sequence:

- Complete internal SPI controller initialization
- Write the appropriate values to specific DAC X₂ registers (see Table 19)
- Enable the thermal alarm with a 100C threshold; disable PPMU and the overvoltage detect (OVD) alarms

The 64th rising edge of SCLK releases $\overline{\text{BUSY}}$ and starts a self-timed DAC deglitch period of approximately 3 μs . DAC voltages begin to change once the deglitch circuits have timed out, and they then require an additional 10 μs to settle to their final values. Thus, a full reset sequence requires approximately 15 μs , comprising 1.28 μs (64 cycles \times 20 ns) for the reset state machine, 3 μs for DAC deglitch, and another 10 μs for settling.

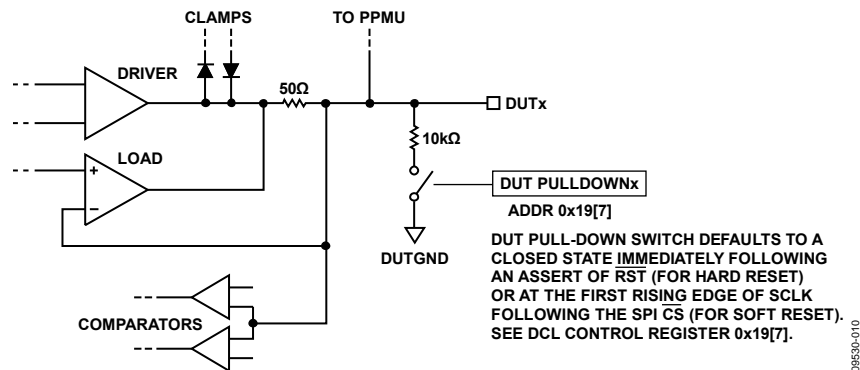
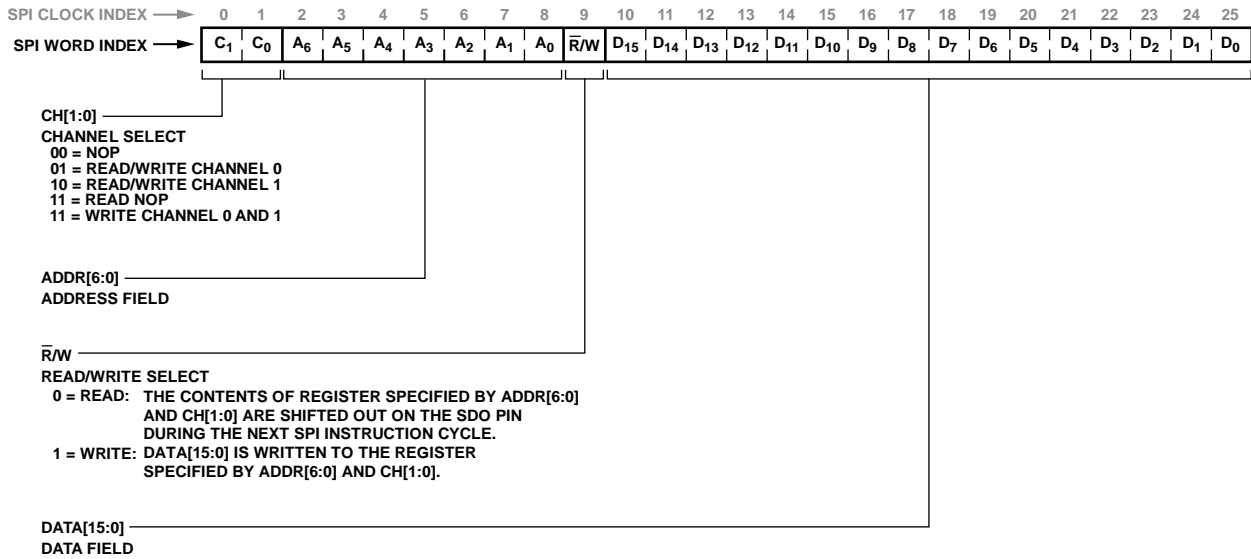

Figure 114. DUTx to V_{DUTGND} Soft Connect Detail

SPI REGISTER DEFINITIONS AND MEMORY MAP



09530-011

Figure 115. SPI Word Definition

Table 19. SPI Register Memory Map

CH[1:0] ^{1, 2}	ADDR[6:0]	R/W ¹	DATA[15:0] ^{1, 3}	Register Description	Reset Value ¹
XX	0x00	X	XXXX	No operation (NOP)	XXXX
CC	0x01	R/W	DDDD	VIH DAC level (reset value = 0.0 V)	0x4000
CC	0x02	R/W	DDDD	VIT/VCOM DAC level (reset value = 0.0 V)	0x4000
CC	0x03	R/W	DDDD	VIL DAC level (reset value = 0.0 V)	0x4000
CC	0x04	R/W	DDDD	VOH DAC level (reset value = +0.5 V))	0x4CCC
CC	0x05	R/W	DDDD	VOL DAC level (reset value = -0.5 V)	0x3333
CC	0x06	R/W	DDDD	VCH DAC level (reset value = +7.5 V)	0xFFFF
CC	0x07	R/W	DDDD	VCL DAC level (reset value = -2.5 V)	0x0000
CC	0x08	R/W	DDDD	VIOH DAC level (reset value = 50 μA)	0x4040
CC	0x09	R/W	DDDD	VIOL DAC level (reset value = 50 μA)	0x4040
CC	0x0A	R/W	DDDD	PPMU DAC level (reset value = 0.0 V)	0x4000
01	0x0B	R/W	DDDD	VHH DAC level (reset value = 0.0 V)	0x2666
01	0x0C	R/W	DDDD	OVDH DAC level (reset value = +7.5 V)	0xFFFF
01	0x0D	R/W	DDDD	OVDL DAC level (reset value = -2.5 V)	0x0000
01	0x0E	R/W	DDDD	Spare DAC level (reset value = 0.0 V)	0x4000
XX	0x0F	X	XXXX	Reserved	XXXX
XX	0x10	X	XXXX	No operation (NOP)	XXXX
CC	0x11	R/W	DDDD	DAC control register	0x0000
01	0x12	R/W	DDDD	SPI control register	0x0000
XX	0x13 to 0x17	X	XXXX	Reserved	XXXX
01	0x18	R/W	DDDD	VHH control register	0x0000
CC	0x19	R/W	DDDD	DCL control register	0x0080
CC	0x1A	R/W	DDDD	PPMU control register	0x0000
CC	0x1B	R/W	DDDD	PPMU MEAS control register	0x0000
CC	0x1C	R/W	DDDD	CMP control register	0x07FE
CC	0x1D	R/W	DDDD	ALARM mask register	0x0045
CC	0x1E	R	DDDD	ALARM state register	0x0000
CC	0x1F	R/W	DDDD	CLC control register	0x0000
XX	0x20	X	XXXX	No operation (NOP)	XXXX
CC	0x21	R/W	DDDD	VIH (driver) m-coefficient	0xFFFF
CC	0x22	R/W	DDDD	VIT (driver) m-coefficient	0xFFFF
CC	0x23	R/W	DDDD	VIL (driver) m-coefficient	0xFFFF
CC	0x24	R/W	DDDD	VOH (normal window comparator) m-coefficient	0xFFFF

CH[1:0] ^{1, 2}	ADDR[6:0]	R/W ¹	DATA[15:0] ^{1, 3}	Register Description	Reset Value ¹
CC	0x25	R/W	DDDD	VOL (normal window comparator) m-coefficient	0xFFFF
CC	0x26	R/W	DDDD	VCH (reflection clamp) m-coefficient	0xFFFF
CC	0x27	R/W	DDDD	VCL (reflection clamp) m-coefficient	0xFFFF
CC	0x28	R/W	DDDD	VIOH (active load) m-coefficient	0xFFFF
CC	0x29	R/W	DDDD	VIOL (active load) m-coefficient	0xFFFF
CC	0x2A	R/W	DDDD	PPMU (PPMU force-voltage) m-coefficient	0xFFFF
01	0x2B	R/W	DDDD	VHH (HVOUT) m-coefficient	0xFFFF
01	0x2C	R/W	DDDD	OVDH (overvoltage) m-coefficient	0xFFFF
01	0x2D	R/W	DDDD	OVDL (overvoltage) m-coefficient	0xFFFF
01	0x2E	R/W	DDDD	Spare DAC m-coefficient	0xFFFF
XX	0x2F	X	XXXX	Reserved	XXXX
XX	0x30	X	XXXX	No operation (NOP)	XXXX
CC	0x31	R/W	DDDD	VIH (driver) c-coefficient	0x8000
CC	0x32	R/W	DDDD	VIT (driver) c-coefficient	0x8000
CC	0x33	R/W	DDDD	VIL (driver) c-coefficient	0x8000
CC	0x34	R/W	DDDD	VOH (normal window comparator) c-coefficient	0x8000
CC	0x35	R/W	DDDD	VOL (normal window comparator) c-coefficient	0x8000
CC	0x36	R/W	DDDD	VCH (reflection clamp) c-coefficient	0x8000
CC	0x37	R/W	DDDD	VCL (reflection clamp) c-coefficient	0x8000
CC	0x38	R/W	DDDD	VIOH (active load) c-coefficient	0x8000
CC	0x39	R/W	DDDD	VIOL (active load) c-coefficient	0x8000
CC	0x3A	R/W	DDDD	PPMU (PPMU force voltage) c-coefficient	0x8000
01	0x3B	R/W	DDDD	VHH (HVOUT) c-coefficient	0x8000
01	0x3C	R/W	DDDD	OVDH (overvoltage) c-coefficient	0x8000
01	0x3D	R/W	DDDD	OVDL (overvoltage) c-coefficient	0x8000
01	0x3E	R/W	DDDD	Spare DAC c-coefficient	0x8000
XX	0x3F	X	XXXX	Reserved	XXXX
XX	0x40	X	XXXX	No operation (NOP)	XXXX
01	0x41	R/W	DDDD	VIH (HVOUT) m-coefficient	0xFFFF
CC	0x42	R/W	DDDD	VCOM (active load) m-coefficient	0xFFFF
01	0x43	R/W	DDDD	VIL (HVOUT) m-coefficient	0xFFFF
01	0x44	R/W	DDDD	VOH (differential comparator) m-coefficient	0xFFFF
CC	0x45	R/W	DDDD	VOH (PPMU measure voltage) m-coefficient	0xFFFF
CC	0x46	R/W	DDDD	VOH (PPMU measure current, Range A) m-coefficient	0xFFFF
CC	0x47	R/W	DDDD	VOH (PPMU measure current Range B) m-coefficient	0xFFFF
CC	0x48	R/W	DDDD	VOH (PPMU measure current, Range C) m-coefficient	0xFFFF
CC	0x49	R/W	DDDD	VOH (PPMU measure current, Range D) m-coefficient	0xFFFF
CC	0x4A	R/W	DDDD	VOH (PPMU measure current, Range E) m-coefficient	0xFFFF
01	0x4B	R/W	DDDD	VOL (differential comparator) m-coefficient	0xFFFF
CC	0x4C	R/W	DDDD	VOL (PPMU measure voltage) m-coefficient	0xFFFF
CC	0x4D	R/W	DDDD	VOL (PPMU measure current, Range A) m-coefficient	0xFFFF
CC	0x4E	R/W	DDDD	VOL (PPMU measure current, Range B) m-coefficient	0xFFFF
CC	0x4F	R/W	DDDD	VOL (PPMU measure current, Range C) m-coefficient	0xFFFF
CC	0x50	R/W	DDDD	VOL (PPMU measure current, Range D) m-coefficient	0xFFFF
CC	0x51	R/W	DDDD	VOL (PPMU measure current, Range E) m-coefficient	0xFFFF
CC	0x52	R/W	DDDD	VCH (PPMU) m-coefficient	0xFFFF
CC	0x53	R/W	DDDD	VCL (PPMU) m-coefficient	0xFFFF
CC	0x54	R/W	DDDD	PPMU force current, Range A m-coefficient	0xFFFF
CC	0x55	R/W	DDDD	PPMU force current, Range B m-coefficient	0xFFFF
CC	0x56	R/W	DDDD	PPMU force current, Range C m-coefficient	0xFFFF
CC	0x57	R/W	DDDD	PPMU force current Range D m-coefficient	0xFFFF
CC	0x58	R/W	DDDD	PPMU force current, Range E m-coefficient	0xFFFF
01	0x59	R/W	DDDD	VIH (HVOUT) c-coefficient	0x8000
CC	0x5A	R/W	DDDD	VCOM (active load) c-coefficient	0x8000
01	0x5B	R/W	DDDD	VIL (HVOUT) c-coefficient	0x8000
01	0x5C	R/W	DDDD	VOH (differential comparator) c-coefficient	0x8000
CC	0x5D	R/W	DDDD	VOH (PPMU measure voltage) c-coefficient	0x8000

CH[1:0]^{1, 2}	ADDR[6:0]	R/W¹	DATA[15:0]^{1, 3}	Register Description	Reset Value¹
CC	0x5E	R/W	DDDD	VOH (PPMU measure current) c-coefficient	0x8000
XX	0x5F to 0x62	X	XXXX	Reserved	XXXX
01	0x63	R/W	DDDD	VOL (differential comparator) c-coefficient	0x8000
CC	0x64	R/W	DDDD	VOL (PPMU measure voltage) c-coefficient	0x8000
CC	0x65	R/W	DDDD	VOL (PPMU measure current) c-coefficient	0x8000
XX	0x66 to 0x69	X	XXXX	Reserved	XXXX
CC	0x6A	R/W	DDDD	VCH (PPMU) c-coefficient	0x8000
CC	0x6B	R/W	DDDD	VCL (PPMU) c-coefficient	0x8000
CC	0x6C	R/W	DDDD	PPMU force current c-coefficient	0x8000
XX	0x6D to 0x70	X	XXXX	Reserved	XXXX

¹ X = don't care.

² CC corresponds to the channel address bits and indicates that there is dedicated register space for each channel.

³ DDDD stands for data.

CONTROL REGISTER DETAILS

Reserved bits in any register are undefined. In some cases, a physical (but unused) memory bit may be present, in other cases not. Write operations have no effect. Read operations result in meaningless but deterministic data.

Any SPI read operation from any reserved bit or register results in an unknown but deterministic readback value.

Any SPI write operation to a control bit or control register defined only on Channel 0 must be addressed to at least Channel 0. Any such write that is addressed only to Channel 1 is ignored. Further, any such write that is addressed to both Channel 0 and Channel 1 (as a multichannel write) proceeds as if the write were addressed only to Channel 0. The data addressed to the undefined Channel 1 control bit or control register is ignored.

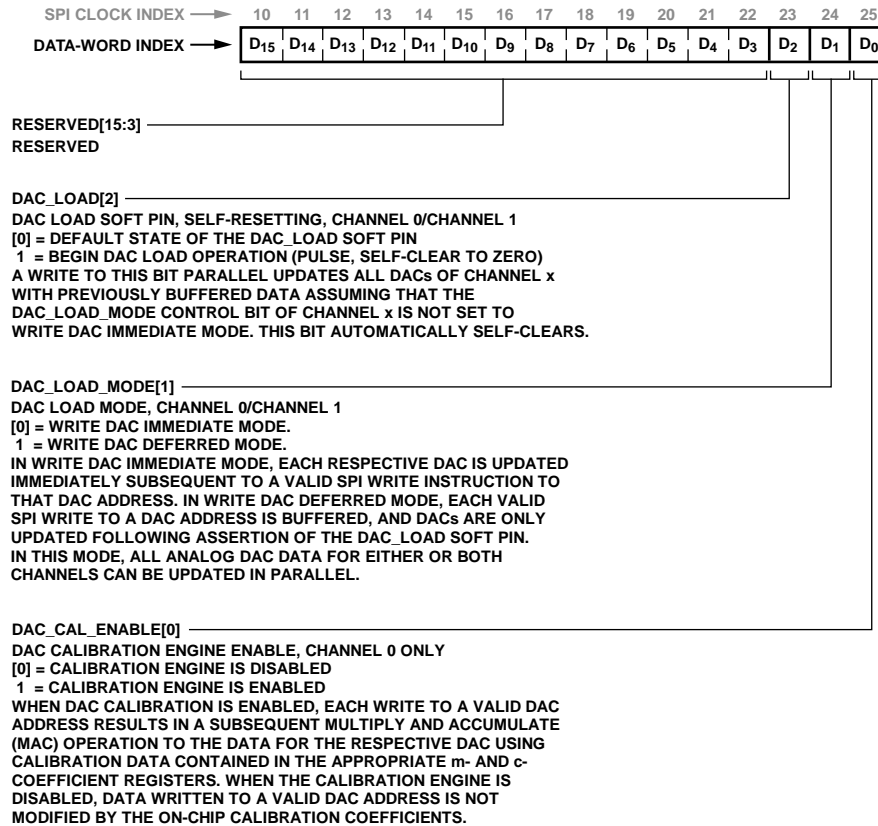

Figure 116. DAC Control Register (ADDR = 0x11)

09530-012

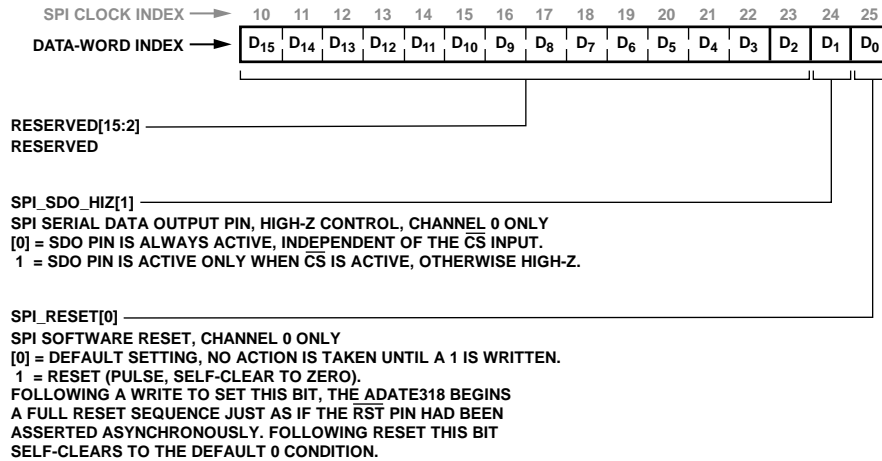

Figure 117. SPI Control Register (ADDR = 0x12)

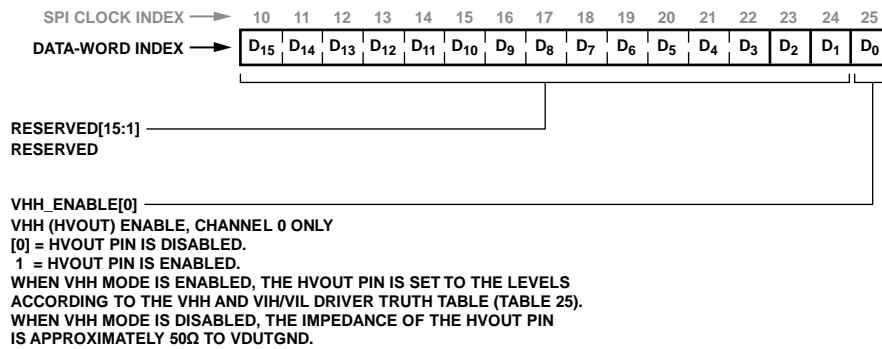
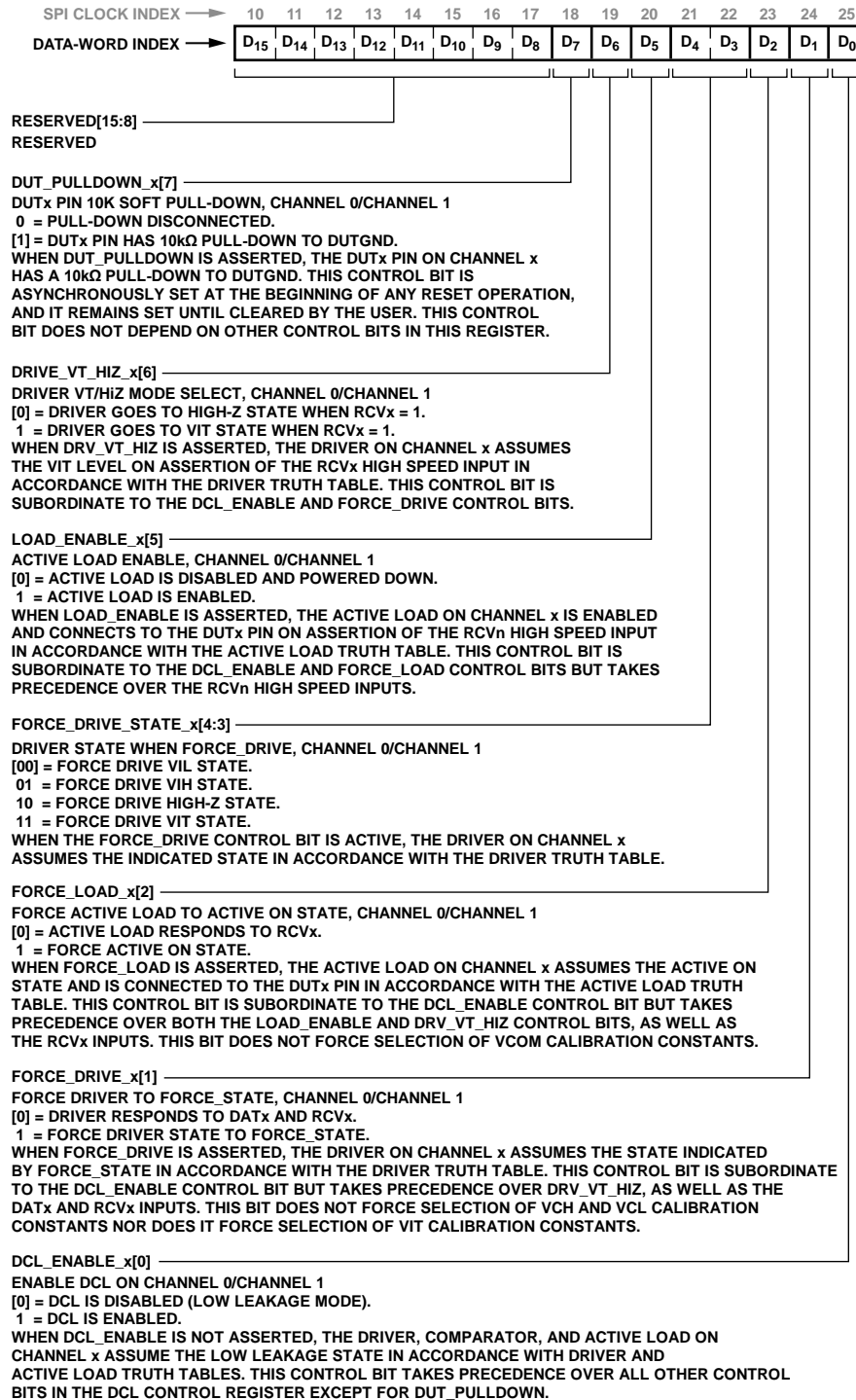
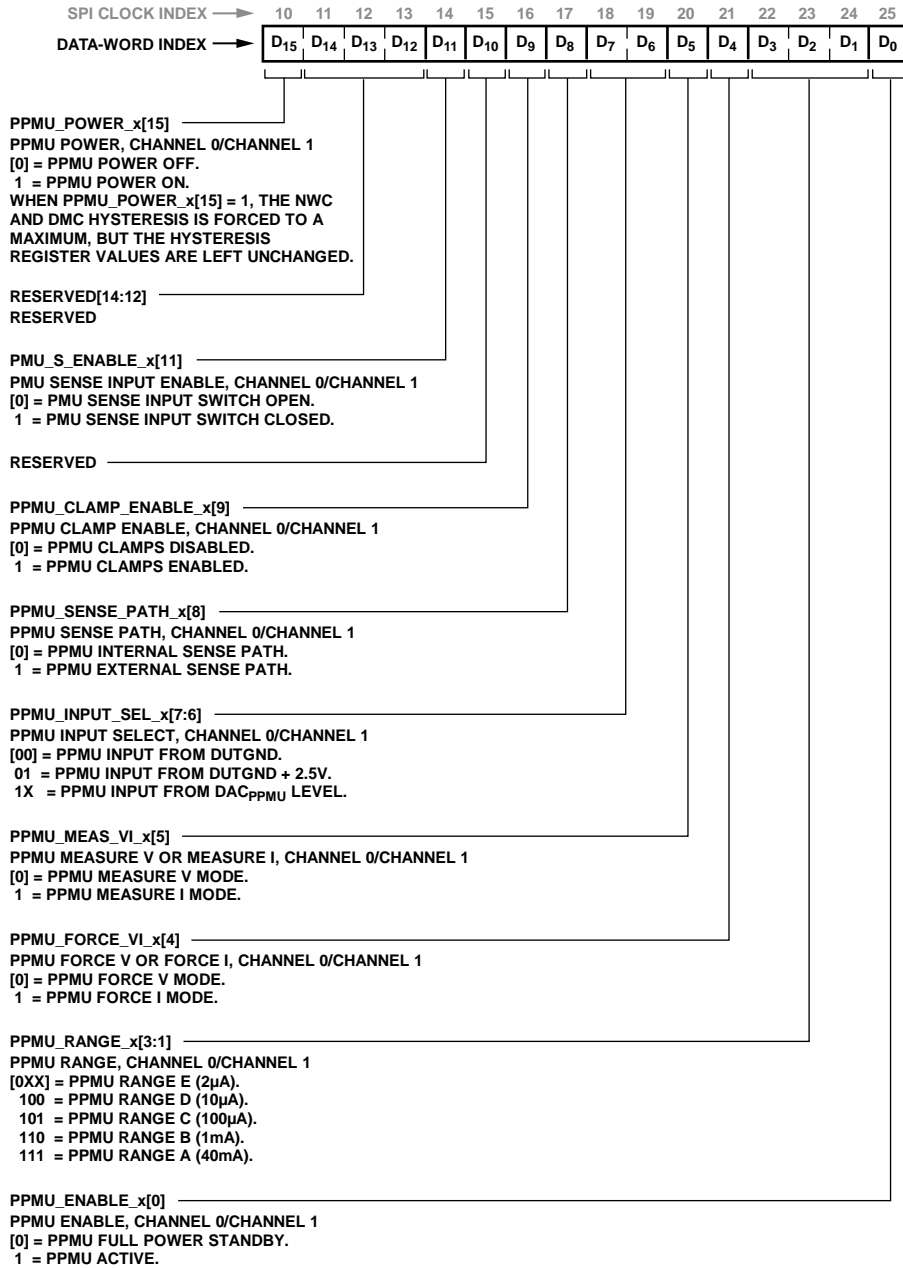

Figure 118. VHH Control Register (ADDR = 0x18) Active Truth Table



06F30-015

Figure 119. DCL Control Register (ADDR = 0x19)



09530-016

Figure 120. PPMU Control Register (ADDR = 0x1A)

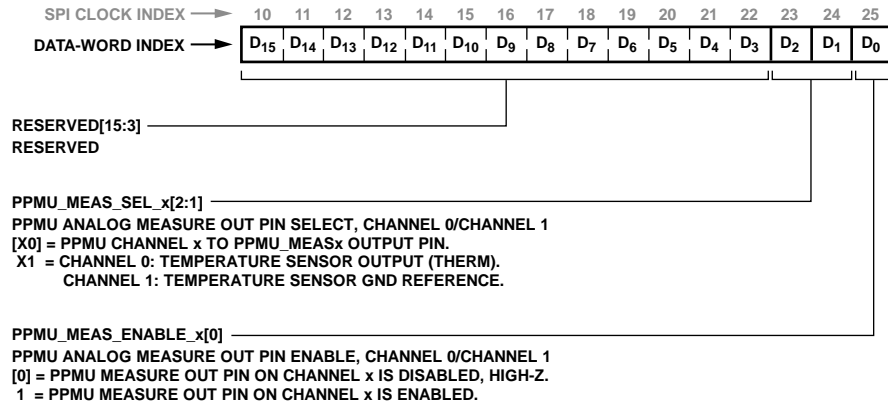

Figure 121. PPMU MEAS Control Register (ADDR = 0x1B)

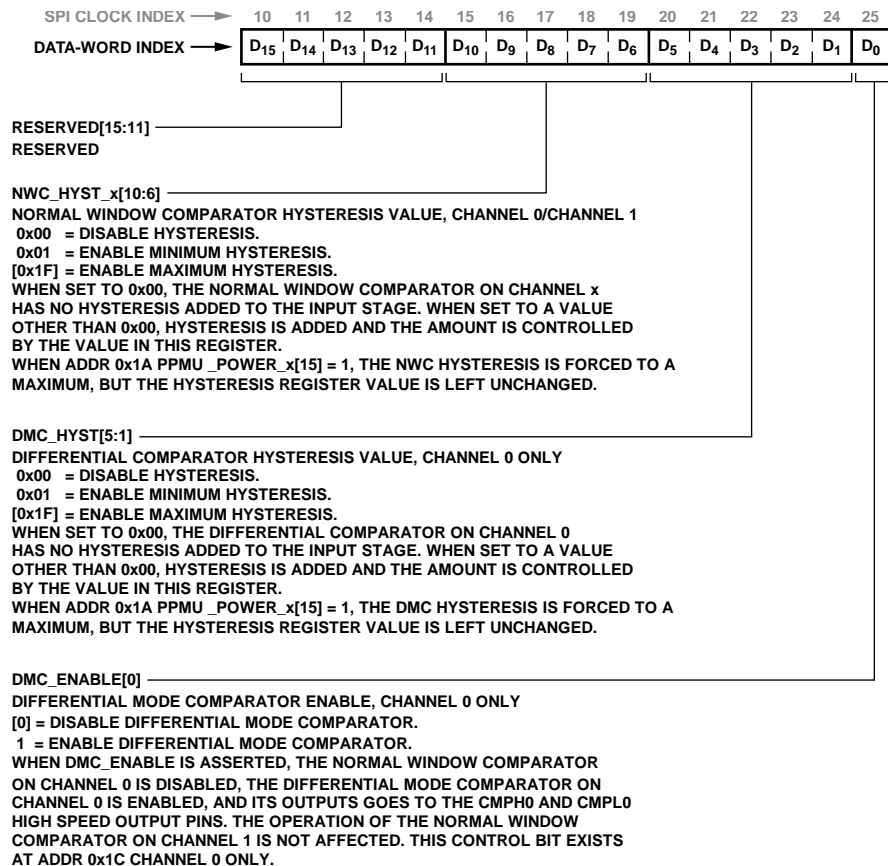
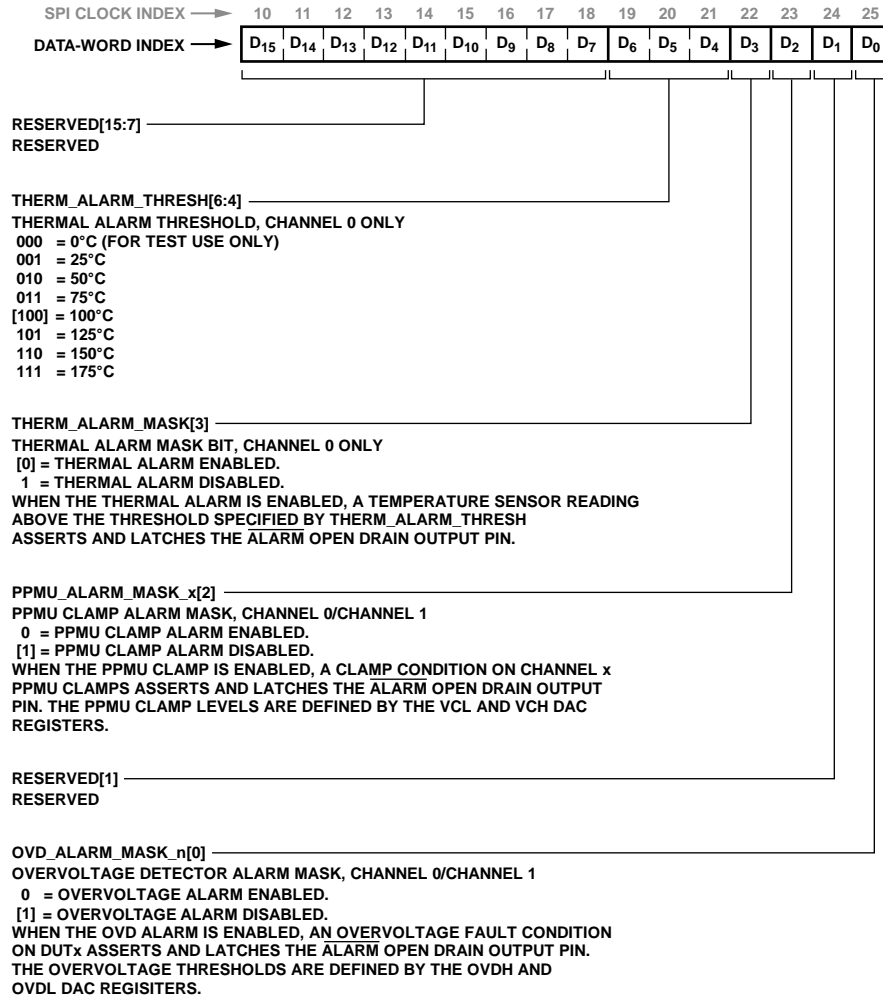
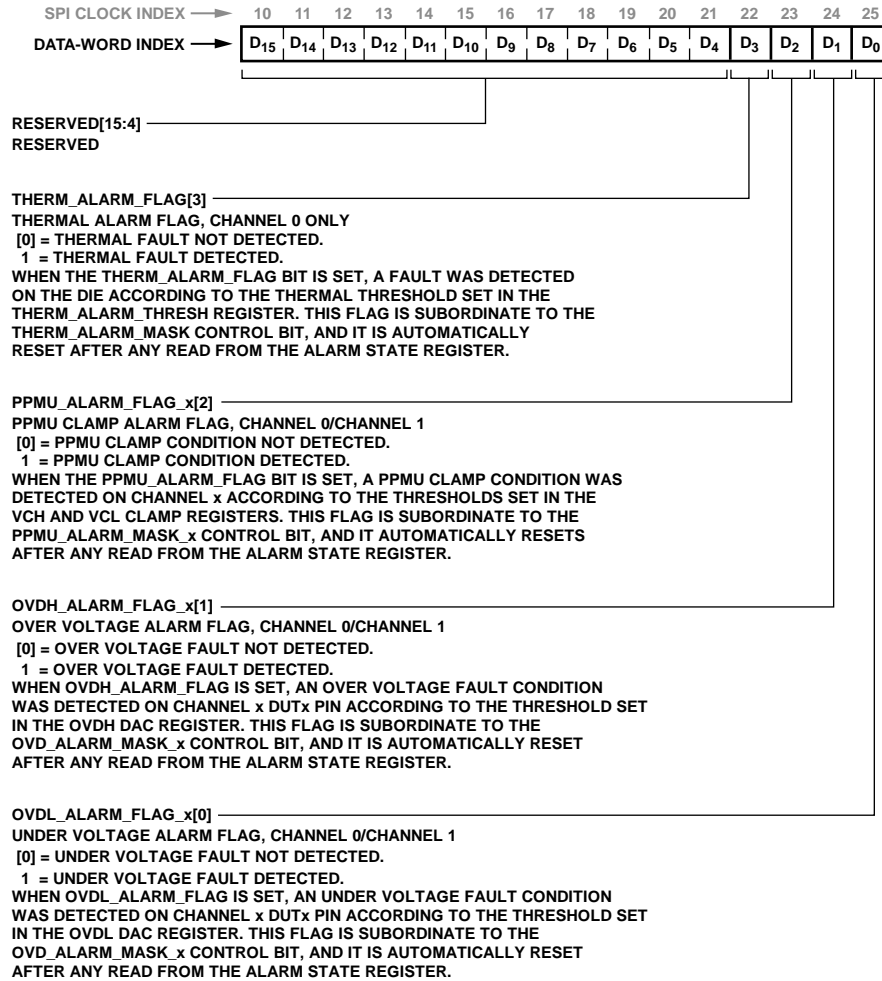

Figure 122. CMP Control Register (ADDR = 0x1C)



06530-019

Figure 123. Alarm Mask Register (ADDR = 0x1D)



09530-420

Figure 124. Alarm State Register (ADDR = 0x1E) (Read Only)

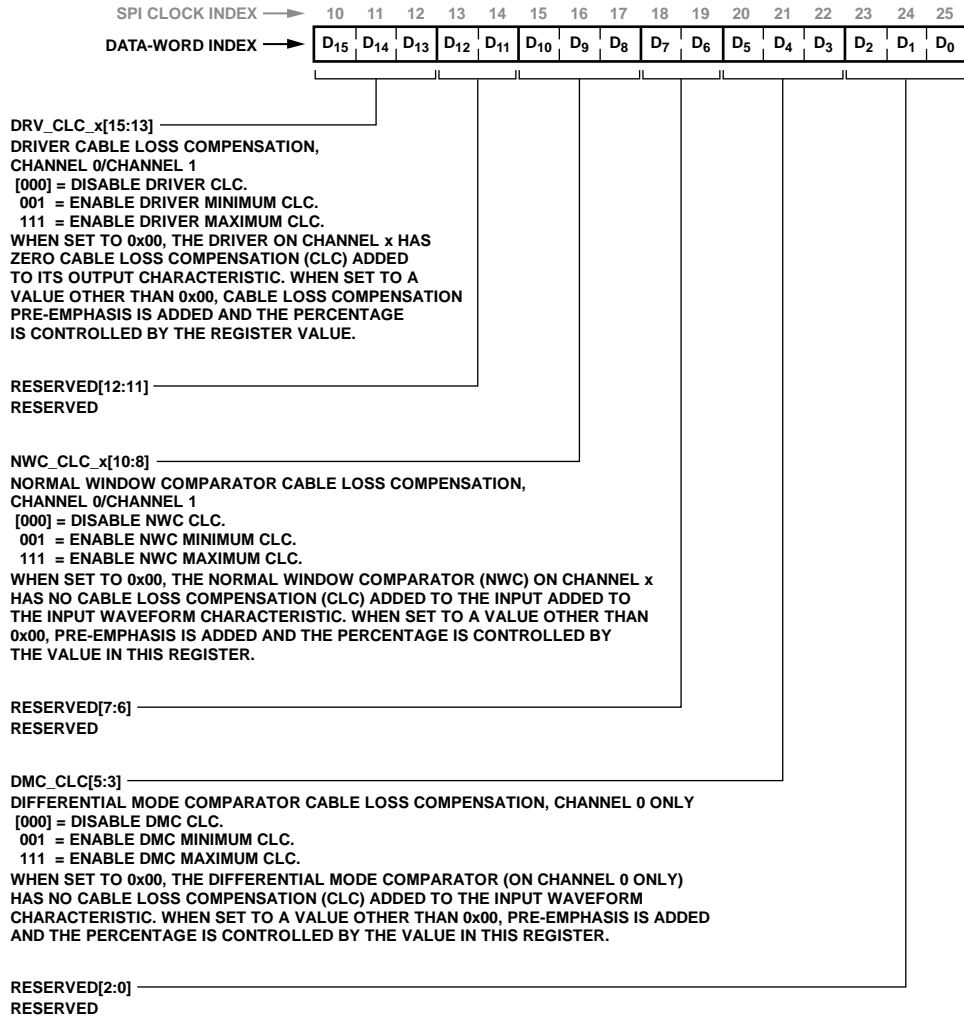

095530-021

Figure 125. CLC Control Register (ADDR = 0x1F)

LEVEL SETTING DACS

DAC UPDATE MODES

The ADATE318 provides 24- × 16-bit integrated level setting DACs organized as two channel banks of 12 DACs each. The detailed mapping of the DAC register to pin electronics function is shown in Table 19. Each DAC can be programmed by writing data to the respective SPI register address and channel.

The ADATE318 provides two methods for updating analog DAC levels: DAC immediate update mode and DAC deferred update mode. At release of the \overline{CS} pin associated with any valid SPI write to a DAC address, the update of analog levels may start immediately¹, or it can be deferred, depending on the state of the DAC_LOAD_MODE control bits in the DAC control register (SPI ADDR 0x11[1] (see Figure 116)). The DAC update mode can be selected independently for each channel bank.

If the DAC_LOAD_MODE control bit for a given channel bank is cleared, the DACs assigned to that channel are then in the DAC immediate update mode. Writing to any DAC of that channel causes the corresponding analog level to be updated immediately following the associated release of \overline{CS} . Because all analog levels are updated on a per-channel basis, any previously pending DAC writes queued to the channel (while in deferred update mode) are also updated at this time. This situation can arise if DAC writes are queued to the channel while in deferred update mode, and the DAC_LOAD_MODE bit is subsequently changed to immediate update mode before the analog levels are updated by writing to the respective DAC_LOAD soft pin. The queued data is not lost. Note that writing to the DAC_LOAD soft pin has no effect in immediate update mode.

If the DAC_LOAD_MODE control bit for a given channel is set, the DACs assigned to that channel are in the deferred update mode. Writing to any DAC of that channel only queues the DAC data into that channel. The analog update of queued DAC levels is deferred until the respective DAC_LOAD soft pin is set (SPI ADDR 0x11[2] (see Figure 116)). The DAC deferred update mode, in conjunction with the respective DAC_LOAD soft pin, provides the means to queue all DAC level writes to a given channel bank before synchronously updating the analog levels with a single SPI command.

Certain pin electronics functions, such as VHH, OVDH, OVDL, and the spare DAC, do not fit neatly within a particular channel bank. However, they must be updated as a part of the channel bank to which they are assigned as shown in Table 19.

The ADATE318 provides a feature in which a single SPI write operation can address two channels at one time (see Figure 115). This feature makes possible a scenario in which a SPI write

operation can address corresponding DACs on both channels at the same time even though the channels may be configured with different DAC update modes. In such a case, the part behaves as expected. For example, if both channels are in immediate update mode, the update of analog levels of both channel banks begins after the associated release of the \overline{CS} pin. If both channels are in deferred update mode, the update of analog levels is deferred for both channels until the corresponding DAC_LOAD bits are set. If one channel is in deferred update mode and the other channel is in immediate update mode, the former channel defers analog updates until the corresponding DAC_LOAD bit is written, and the latter channel begins analog updates immediately after the associated release of the \overline{CS} pin.

An on-chip deglitch circuit with a period of approximately 3 μ s is provided to prevent DAC-to-DAC crosstalk whenever an analog update is processed. Only one deglitch circuit is provided per chip, and it must operate over all physical DACs (both channels) at the same time. The deglitch circuit can be retriggered when an analog levels update is initiated before a previous update operation has completed. In the case of a dual-channel immediate mode DAC write using a single SPI command, the deglitch circuit is triggered once after data is loaded into both DAC channels. Analog transitions at the DAC outputs do not begin until the deglitch circuit has timed out, and final settling to full precision requires an additional 7 μ s beyond the end of the 3 μ s deglitch interval. Total settling time following release of the associated \overline{CS} is approximately 10 μ s. Note that prolonged and consecutive retriggering of the deglitch circuit by one channel may cause the apparent settling time of analog levels on the other channel to be much longer than the specified 10 μ s.

A typical DAC update sequence is illustrated in Figure 126 in which two immediate mode DAC update commands are written in direct succession. This example illustrates what happens when a DAC update command is written subsequent to a previous update command that has not yet finished its deglitch and settling sequence.

Recommended Sequence for OVDH DAC Level Addressing

For correct OVDH addressing, first write data to the OVDH DAC level at SPI 0x0C at CH0. If in DAC immediate mode, the OVDH data write must be followed by either a DAC_LOAD command to SPI 0x11[2] at CH1 or a subsequent write to any other CH1 DAC data address before the OVDH value will be updated. If in DAC deferred mode, the OVDH DAC level write must be followed by a DAC_LOAD command to SPI 0x11[2] at CH1 (not CH0) before the analog OVDH value will be updated.

¹ Initiation of the analog level update sequence (and triggering of the on-chip deglitch circuit) actually begins four SCLK cycles following the associated release of the \overline{CS} pin. For the purpose of this discussion, it is assumed to start coincident with the release of \overline{CS} .

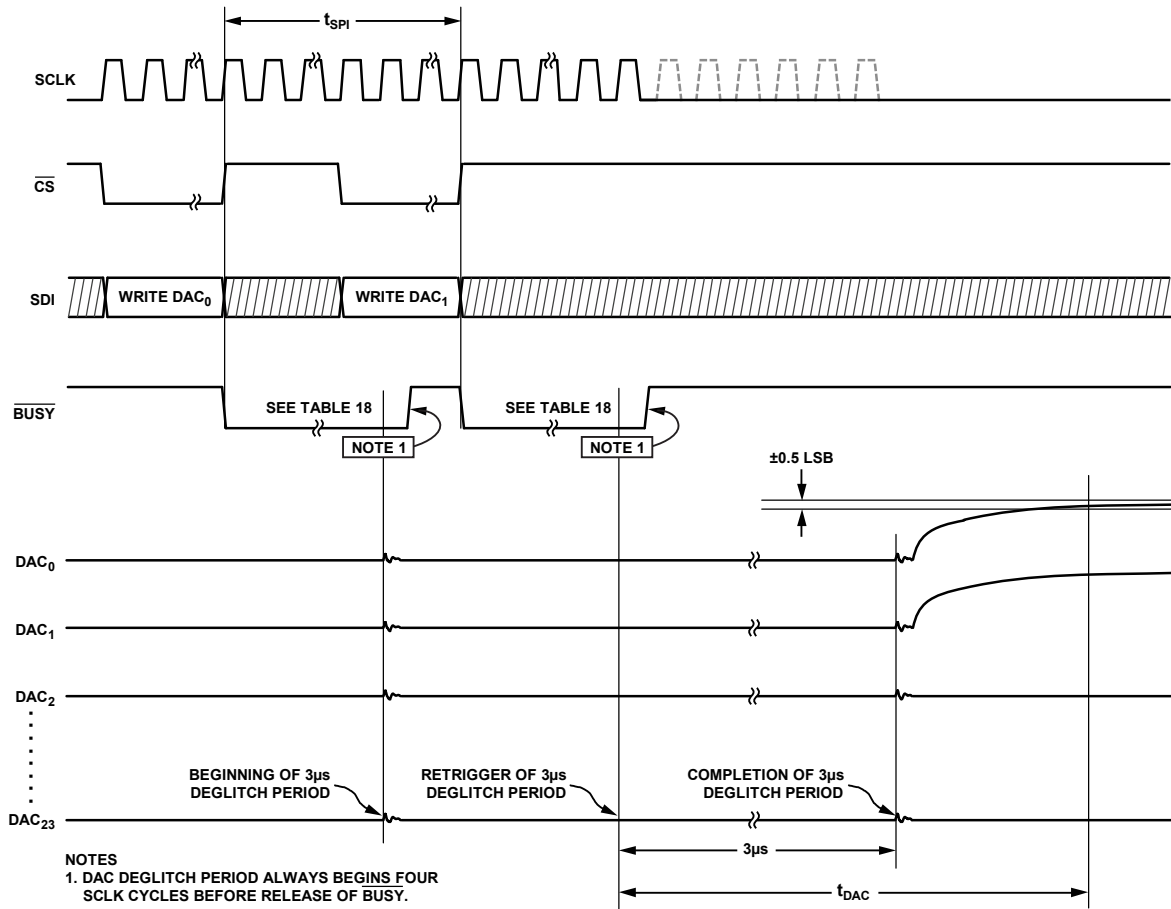

Addressing M and C Registers

Some DACs have pairs of m/c-coefficients that are controlled depending on other register status. Table 20 details the specific register settings and register addresses for the different pairs (X = don't care).

Table 20. M- and C-Register Mapping

SPI Address (Channel)	DAC Name	Functional (DAC Usage) Description	m-register	c-register	VHH_ENABLE 0x18[0]	DMC_ENABLE 0x1C[0]	LOAD_ENABLEx 0x19[5]	PPMU_POWERx 0x1A[15]	PPMU_MEAS_VIx 0x1A[5]	PPMU_FORCE_VIx 0x1A[4]	PPMU_RANGEx (0x1A[3:1])
0x0D[0]	OVDL	Overvoltage detect low	0x2D[0]	0x3D[0]	X	X	X	X	X	X	XXX
0x04[0]	VOH0	NWC high level, Channel 0	0x24[0]	0x34[0]	X	0	X	0	X	X	XXX
		DMC high level	0x44[0]	0x5C[0]	X	1	X	0	X	X	XXX
		PPMU go/no-go MV high level, Channel 0	0x45[0]	0x5D[0]	X	X	X	1	0	X	XXX
		PPMU go/no-go MI Range A high level, Channel 0	0x46[0]	0x5E[0]	X	X	X	1	1	X	111
		PPMU go/no-go MI Range B high level, Channel 0	0x47[0]	0x5E[0]	X	X	X	1	1	X	110
		PPMU go/no-go MI Range C high level, Channel 0	0x48[0]	0x5E[0]	X	X	X	1	1	X	101
		PPMU go/no-go MI Range D high level, Channel 0	0x49[0]	0x5E[0]	X	X	X	1	1	X	100
		PPMU go/no-go MI Range E high level, Channel 0	0x4A[0]	0x5E[0]	X	X	X	1	1	X	0XX

SPI Address (Channel)	DAC Name	Functional (DAC Usage) Description	m-register	c-register	VHH_ENABLE 0x18[0]	DMC_ENABLE 0x1C[0]	LOAD_ENABLEx 0x19[5]	PPMU_POWERx 0x1A[15]	PPMU_MEAS_VIx 0x1A[5]	PPMU_FORCE_VIx 0x1A[4]	PPMU_RANGEx (0x1A[3:1])
0x05[0]	VOLO	NWC low level, Channel 0	0x25[0]	0x35[0]	X	0	X	0	X	X	XXX
		DMC low level	0x4B[0]	0x63[0]	X	1	X	0	X	X	XXX
		PPMU go/no-go MV low level, Channel 0	0x4C[0]	0x64[0]	X	X	X	1	0	X	XXX
		PPMU go/no-go MI Range A low level, Channel 0	0x4D[0]	0x65[0]	X	X	X	1	1	X	111
		PPMU go/no-go MI Range B low level, Channel 0	0x4E[0]	0x65[0]	X	X	X	1	1	X	110
		PPMU go/no-go MI Range C low level, Channel 0	0x4F[0]	0x65[0]	X	X	X	1	1	X	101
		PPMU go/no-go MI Range D low level, Channel 0	0x50[0]	0x65[0]	X	X	X	1	1	X	100
		PPMU go/no-go MI Range E low level, Channel 0	0x51[0]	0x65[0]	X	X	X	1	1	X	0XX
0x08[0]	VIOH0	Load IOH level, Channel 0	0x28[0]	0x38[0]	X	X	X	X	X	X	XXX
0x09[0]	VIOL0	Load IOL level, Channel 0	0x29[0]	0x39[0]	X	X	X	X	X	X	XXX
0x02[0]	VIT0/ VCOM0	Drive term level, Channel 0	0x22[0]	0x32[0]	X	X	0	X	X	X	XXX
		Load commutation voltage, Channel 0	0x42[0]	0x5A[0]	X	X	1	X	X	X	XXX
0x01[0]	VIH0	Drive high level, Channel 0	0x21[0]	0x31[0]	0	X	X	X	X	X	XXX
		HVOUT drive high level, Channel 0	0x41[0]	0x59[0]	1	X	X	X	X	X	XXX
0x03[0]	VIL0	Drive low level, Channel 0	0x23[0]	0x33[0]	0	X	X	X	X	X	XXX
		HVOUT drive low level, Channel 0	0x43[0]	0x5B[0]	1	X	X	X	X	X	XXX
0x06[0]	VCH0	Ref clamp high level, Channel 0	0x26[0]	0x36[0]	X	X	X	0	X	X	XXX
		PPMU clamp high level, Channel 0	0x52[0]	0x6A[0]	X	X	X	1	X	X	XXX
0x07[0]	VCL0	Ref clamp low level, Channel 0	0x27[0]	0x37[0]	X	X	X	0	X	X	XXX
		PPMU clamp low level, Channel 0	0x53[0]	0x6B[0]	X	X	X	1	X	X	XXX
0x0A[0]	PPMU0	PPMU VIN FV level, Channel 0	0x2A[0]	0x3A[0]	X	X	X	X	X	0	XXX
		PPMU VIN FI Range A level, Channel 0	0x54[0]	0x6C[0]	X	X	X	X	X	1	111
		PPMU VIN FI Range B level, Channel 0	0x55[0]	0x6C[0]	X	X	X	X	X	1	110
		PPMU VIN FI Range C level, Channel 0	0x56[0]	0x6C[0]	X	X	X	X	X	1	101
		PPMU VIN FI Range D Level, Channel 0	0x57[0]	0x6C[0]	X	X	X	X	X	1	100
		PPMU VIN FI Range E level, Channel 0	0x58[0]	0x6C[0]	X	X	X	X	X	1	0XX
0x0B[0]	VHH	VHH level	0x2B[0]	0x3B[0]	X	X	X	X	X	X	XXX
0x0C[0]	OVDH	Overvoltage detect high	0x2C[0]	0x3C[0]	X	X	X	X	X	X	XXX

SPI Address (Channel)	DAC Name	Functional (DAC Usage) Description	m-register	c-register	VHH_ENABLE 0x18[0]	DMC_ENABLE 0x1C[0]	LOAD_ENABLEx 0x19[5]	PPMU_POWERx 0x1A[15]	PPMU_MEAS_VIx 0x1A[5]	PPMU_FORCE_VIx 0x1A[4]	PPMU_RANGEx (0x1A[3:1])
0x04[1]	VOH1	NWC high level, Channel 1	0x24[1]	0x34[1]	X	X	X	0	X	X	XXX
		PPMU go/no-go MV high level, Channel 1	0x45[1]	0x5D[1]	X	X	X	1	0	X	XXX
		PPMU go/no-go MI Range A high level, Channel 1	0x46[1]	0x5E[1]	X	X	X	1	1	X	111
		PPMU go/no-go MI Range B high level, Channel 1	0x47[1]	0x5E[1]	X	X	X	1	1	X	110
		PPMU go/no-go MI Range C high level, Channel 1	0x48[1]	0x5E[1]	X	X	X	1	1	X	101
		PPMU go/no-go MI Range D high level, Channel 1	0x49[1]	0x5E[1]	X	X	X	1	1	X	100
		PPMU go/no-go MI Range E high level, Channel 1	0x4A[1]	0x5E[1]	X	X	X	1	1	X	0XX
		0x05[1]	VOL1	NWC low level, Channel 1	0x25[1]	0x35[1]	X	X	X	0	X
PPMU go/no-go MV low level, Channel 1	0x4C[1]			0x64[1]	X	X	X	1	0	X	XXX
PPMU go/no-go MI Range A low level, Channel 1	0x4D[1]			0x65[1]	X	X	X	1	1	X	111
PPMU go/no-go MI Range B low level, Channel 1	0x4E[1]			0x65[1]	X	X	X	1	1	X	110
PPMU go/no-go MI Range C low level, Channel 1	0x4F[1]			0x65[1]	X	X	X	1	1	X	101
PPMU go/no-go MI Range D low level, Channel 1	0x50[1]			0x65[1]	X	X	X	1	1	X	100
PPMU go/no-go MI Range E low level, Channel 1	0x51[1]			0x65[1]	X	X	X	1	1	X	0XX
0x08[1]	VIOH1			Load IOH level, Channel 1	0x28[1]	0x38[1]	X	X	X	X	X
0x09[1]	VIOL1	Load IOL level, Channel 1	0x29[1]	0x39[1]	X	X	X	X	X	X	XXX
0x02[1]	VIT1/VCOM1	Drive term level, Channel 0	0x22[1]	0x32[1]	X	X	0	X	X	X	XXX
		Load commutation voltage, Channel 1	0x42[1]	0x5A[1]	X	X	1	X	X	X	XXX
0x01[1]	VIH1	Drive high level, Channel 1	0x21[1]	0x31[1]	X	X	X	X	X	X	XXX
0x03[1]	VIL1	Drive low level, Channel 1	0x23[1]	0x33[1]	X	X	X	X	X	X	XXX
0x06[1]	VCH1	Ref clamp high level, Channel 1	0x26[1]	0x36[1]	X	X	X	0	X	X	XXX
		PPMU clamp high level, Channel 1	0x52[1]	0x6A[1]	X	X	X	1	X	X	XXX
0x07[1]	VCL1	Ref clamp low level, Channel 1	0x27[1]	0x37[1]	X	X	X	0	X	X	XXX
		PPMU clamp low level, Channel 1	0x53[1]	0x6B[1]	X	X	X	1	X	X	XXX
0x0A[1]	PPMU1	PPMU VIN FV level, Channel 1	0x2A[1]	0x3A[1]	X	X	X	X	X	0	XXX
		PPMU VIN FI Range A level, Channel 1	0x54[1]	0x6C[1]	X	X	X	X	X	1	111
		PPMU VIN FI Range B level, Channel 1	0x55[1]	0x6C[1]	X	X	X	X	X	1	110
		PPMU VIN FI Range C level, Channel 1	0x56[1]	0x6C[1]	X	X	X	X	X	1	101
		PPMU VIN FI Range D level, Channel 1	0x57[1]	0x6C[1]	X	X	X	X	X	1	100
		PPMU VIN FI Range E level, Channel 1	0x58[1]	0x6C[1]	X	X	X	X	X	1	0XX

SPI Address (Channel)	DAC Name	Functional (DAC Usage) Description	m-register	c-register	VHH_ENABLE 0x18[0]	DMC_ENABLE 0x1C[0]	LOAD_ENABLEx 0x19[5]	PPMU_POWERx 0x1A[15]	PPMU_MEAS_VIx 0x1A[5]	PPMU_FORCE_VIx 0x1A[4]	PPMU_RANGEx (0x1A[3:1])
0x0E[0]	Spare	Spare level	0x2E[0]	0x3E[1]	X	X	X	X	X	X	XXX

DAC TRANSFER FUNCTIONS

Table 21. Detailed DAC Code to Voltage Level Transfer Functions

Levels	Programmable DAC Range ¹ , 0x0000 to 0xFFFF	DAC-to-Level and Level-to-DAC Transfer Functions
VIHx, VILx, VITx/VCOMx, VOLx, VOHx, VCHx, VCLx, OVDHx, OVDLx	-2.5 V to +7.5 V	$V_{OUT} = 2 \times (VREF - VREFGND) \times (DAC/2^{16}) - 0.5 \times (VREF - VREFGND) + V_{DUTGND}$ $DAC = [(V_{OUT} - V_{DUTGND} + 0.5 \times (VREF - VREFGND))] \times [(2^{16}) / (2 \times (VREF - VREFGND))]$
VHH	-3.0 V to +17.0 V	$V_{OUT} = 4 \times (VREF - VREFGND) \times (DAC/2^{16}) - 0.6 \times (VREF - VREFGND) + V_{DUTGND}$ $DAC = [(V_{OUT} - V_{DUTGND} + 0.6 \times (VREF - VREFGND))] \times [2^{16} / (4 \times (VREF - VREFGND))]$
IOHx, IOLx	-12.5 mA to +37.5 mA	$I_{OUT} = [2 \times (VREF - VREFGND) \times (DAC/2^{16}) - 0.5 \times (VREF - VREFGND)] \times (25 \text{ mA}/5)$ $DAC = [(I_{OUT} \times (5/25 \text{ mA})) + 0.5 \times (VREF - VREFGND)] \times [2^{16} / (2 \times (VREF - VREFGND))]$
PPMU_VINx (FV)	-2.5 V to +7.5 V	$V_{OUT} = 2 \times (VREF - VREFGND) \times (DAC/2^{16}) - 0.5 \times (VREF - VREFGND) + V_{DUTGND}$ $DAC = [(V_{OUT} - V_{DUTGND} + 0.5 \times (VREF - VREFGND))] \times [2^{16} / (2 \times (VREF - VREFGND))]$
PPMU_VINx (FI, Range A)	-80 mA to +80 mA	$I_{OUT} = [2 \times (VREF - VREFGND) \times (DAC/2^{16}) - 0.5 \times (VREF - VREFGND) - 2.5] \times (80 \text{ mA}/5)$ $DAC = [(I_{OUT} \times (5/80 \text{ mA})) + 2.5 + 0.5 \times (VREF - VREFGND)] \times [2^{16} / (2 \times (VREF - VREFGND))]$
PPMU_VINx (FI, Range B)	-2 mA to +2 mA	$I_{OUT} = [2 \times (VREF - VREFGND) \times (DAC/2^{16}) - 0.5 \times (VREF - VREFGND) - 2.5] \times (2 \text{ mA}/5)$ $DAC = [(I_{OUT} \times (5/2 \text{ mA})) + 2.5 + 0.5 \times (VREF - VREFGND)] \times [2^{16} / (2 \times (VREF - VREFGND))]$
PPMU_VINx (FI, Range C)	-200 µA to +200 µA	$I_{OUT} = [2 \times (VREF - VREFGND) \times (DAC/2^{16}) - 0.5 \times (VREF - VREFGND) - 2.5] \times (200 \text{ µA}/5)$ $DAC = [(I_{OUT} \times (5/200 \text{ µA})) + 2.5 + 0.5 \times (VREF - VREFGND)] \times [2^{16} / (2 \times (VREF - VREFGND))]$
PPMU_VINx (FI, Range D)	-20 µA to +20 µA	$I_{OUT} = [2 \times (VREF - VREFGND) \times (DAC/2^{16}) - 0.5 \times (VREF - VREFGND) - 2.5] \times (20 \text{ µA}/5)$ $DAC = [(I_{OUT} \times (5/20 \text{ µA})) + 2.5 + 0.5 \times (VREF - VREFGND)] \times [2^{16} / (2 \times (VREF - VREFGND))]$
PPMU_VINx (FI, Range E)	-4 µA to +4 µA	$I_{OUT} = [2 \times (VREF - VREFGND) \times (DAC/2^{16}) - 0.5 \times (VREF - VREFGND) - 2.5] \times (4 \text{ µA}/5)$ $DAC = [(I_{OUT} \times (5/4 \text{ µA})) + 2.5 + 0.5 \times (VREF - VREFGND)] \times [2^{16} / (2 \times (VREF - VREFGND))]$

¹ Programmable ranges include the margin outside the specified performance range, allowing for offset and gain calibration.

Table 22. Load Transfer Functions

Load Level	Transfer Functions	Notes
IOLx	$V_{IOLx} / (VREF - VREFGND) \times 25 \text{ mA}$	VIOLx and VIOHx DAC levels are not referenced to V_{DUTGND} .
IOHx	$V_{IOHx} / (VREF - VREFGND) \times 25 \text{ mA}$	

Table 23. PPMU Transfer Functions

PPMU Mode	Transfer Functions ¹	Uncalibrated PPMU_VIN DAC Settings to Achieve Specified PPMU Range
FV	$V_{OUT} = \text{PPMU_VINx}$	-2.0 V < PPMU_VINx < +6.5 V
MV	$V_{PPMU_MEASx} = V_{DUTx}$ (internal sense path)	N/A
MV	$V_{PPMU_MEASx} = V_{PPMU_Sx}$ (external sense path)	N/A
FI	$I_{OUT} = [\text{PPMU_VINx} - (VREF - VREFGND)] / (2 / (5 \times R_{PPMU}))$	0.0 V < PPMU_VINx < 5.0 V
MI	$V_{PPMU_MEASx} = [(VREF - VREFGND) / 2] + (5 \times I_{OUT} \times R_{PPMU}) + V_{DUTGND}$	N/A

¹ RPPMU = 12.5 Ω for Range A, 500 Ω for Range B, 5.0 kΩ for Range C, 50 kΩ for Range D, and 250 kΩ for Range E.

Table 24. VHH Transfer Functions

VHH Mode	Transfer Functions
VHH	$HV_{OUT} = 2 \times [VHH + (VREF - VREFGND) / 5] + V_{DUTGND}$
VIL	$HV_{OUT} = V_{IL0} + V_{DUTGND}$
VIH	$HV_{OUT} = V_{IH0} + V_{DUTGND}$

GAIN AND OFFSET CORRECTION

Each DAC within the ADATE318 has independent gain (m) and offset (c) correction registers that allow digital trim of gain and offset errors. DACs that are shared between functions or levels are provided with per-level or per-function gain and offset correction registers, as appropriate. These registers provide the ability to calibrate out errors in the complete signal chain, which includes error in pin electronics function as well as the DACs. All m - and c -registers are volatile and must be loaded after power-on as part of a calibration cycle if values other than the defaults are required.

The gain and offset correction function can be bypassed by clearing the DAC_CAL_ENABLE bit in the SPI DAC control register (SPI ADDR 0x11[0]; see Figure 116). This bypass mode is available on a per-chip basis only; that is, it is not possible to bypass calibration for a subset of the DACs.

The calibration function, when enabled, adjusts the numerical data sent to each DAC according to the following equation:

$$X_2 = \left[\left(\frac{m+1}{2^n} \right) \times X_1 \right] + (c - 2^{n-1})$$

where:

X_2 = the data-word loaded into the DAC and returned by an SPI read operation.

X_1 = the 16-bit data-word written to the DAC SPI input register.

m = the code in the respective DAC gain register (default code = 0xFFFF = $2^n - 1$).

c = the code in the respective DAC offset register (default code = 0x8000 = 2^{n-1}).

n = the DAC resolution ($n = 16$).

From this equation, it can be seen that the gain applied to the X_1 value is always less than or equal to 1.0, with the effect that a DAC's output voltage can only be made smaller. To compensate for this numerically imposed limitation, the ADATE318's signal paths are designed to have gain guaranteed to be greater than 1.0 when the default m values (0xFFFF) are applied. This guarantees that proper gain calibration is always possible. Note also that the value of c is expressed in raw DAC LSBs; that is, it is calculated without considering the effect of the m -register.

When enabled, the calibration function applies the above operation to the X_2 register(s) only after a SPI write to the respective X_1 register(s). The X_2 registers are not updated after writes to either the m - or c -register. In the case of a dual channel write to the DAC, two respective X_2 registers are sequentially updated using the appropriate m and c values.

X_2 REGISTERS

Each DAC has associated with it a single X_2 register. There is no provision for storing separate X_2 values for DACs shared between functions or ranges. Thus, new data must be written to any shared DAC after a mode or range change is performed, even if the old and new DAC data is identical. The ADATE318 provides separate m - and c -registers for all ranges and modes so

that the new X_2 value is calculated correctly following the new data write, provided the desired m and c values are stored in advance. The sequence of operations is critical in that the mode or range change must be performed prior to writing the new DAC data, and both m and c values must be present before the new DAC data is written. The m and/or c value can be written either before or after a mode or range change but must be written prior to the DAC data to have the intended effect.

SAMPLE CALCULATIONS OF M AND C

Because the ADATE318's on-chip DACs have a theoretical output range that exceeds the operating capabilities of the remainder of its signal channels, calibration points must be chosen to be within the normal operating span. Subject to this constraint, calibration is straightforward. One of the keys to understanding the calibration method is to recognize that the intrinsic DAC offset is defined by its output when the input code is 0x0000. This is quite different from the case of the analog signal paths, where a 0 V level occurs when the DAC code is programmed to near quarter-scale.

As a first example, consider the calibration of a drive high level with a theoretical output span of -2.5 V to $+7.5$ V, a convenient $+10.0$ V span in which DAC quarter-scale corresponds to precisely 0.0 V out. The ADATE318 drivers do not of course support this full span, but it is a useful choice for illustration of the calibration methodology.

1. Set the channel to drive high and program the VIL and VIH DACs for roughly -1.0 V outputs (Code 0x2700, not critical). Program the VIH DAC to quarter-scale (0x4000) and measure Output Voltage V_1 ; then program the DAC to three-quarter-scale (0xC000) and measure Output Voltage V_2 . Note that V_1 and V_2 should be measured with respect to DUTGND.
2. Calculate

$$Actual_DAC_FSR = 2 \times (V_2 - V_1)$$
 where $(V_2 - V_1)$ represents half the full-scale span.
3. Calculate the extrapolated DAC voltage at Code 0x0000.

$$V_0 = V_1 - \left(\frac{Actual_DAC_FSR}{4} \right)$$

4. Calculate

$$Actual_DAC_LSB = \frac{(V_2 - V_1)}{32,768}$$
5. Calculate

$$m = \left[\frac{5}{(V_2 - V_1)} \times 65,536 \right] - 1$$
6. Calculate the offset from the ideal -2.5 V.

$$Offset = (-2.5) - V_0$$

7. Calculate

$$c = 32,768 + \left(\frac{\text{Offset}}{\text{Actual_DAC_LSB}} \right)$$

8. Calculate volts

$$\text{Post_Calibration_DAC_LSB} = \text{Actual_DAC_LSB} \times \left(\frac{5}{V_2 - V_1} \right)$$

The above procedure places the DAC's theoretical 0x0000 output at -2.5 V and its theoretical 0xFFFF output at +7.49985 V (1 LSB below +7.5 V). The useful range extends from below 0x199A (-1.5 V) to above 0xE666 (+6.5 V), a span of at least 52,428 actual DAC codes.

An alternative calibration approach can be used to map all 2^{16} DAC codes onto the part's specified output range by mapping the zero-code to -1.5 V and the full-scale code to +6.5 V.

1. Repeat Step 1 to Step 4 above.
2. Calculate

$$m = \frac{4}{(V_2 - V_1)} \times 65,535$$

3. Calculate the offset from the desired -1.5 V.

$$\text{Offset} = (-1.5) - V_0$$

4. Calculate DAC

$$c = 32,768 + \left(\frac{\text{Offset}}{\text{Actual_DAC_LSB}} \right)$$

5. Calculate

$$\text{Post_Calibration_DAC_LSB} = \frac{8}{65,536} \text{ Volts}$$

Although this second approach gives an apparent 16 bits of resolution covering the full signal range, it must be kept in mind that this is achieved purely by mathematical alteration of the DAC data. The DAC's internal LSB step size is not changed. In this example, the number of internal DAC codes used to cover the signal span remains roughly 52,428 even though the number of user codes has increased to 65,536. A consequence of this is that apparent DNL errors are increased as more input codes are mapped onto the same number of DAC codes. While the second calibration method is included here as an example of what is possible, its use can provide a false sense of improved accuracy and it is therefore not recommended.

POWER SUPPLY, GROUNDING, AND DECOUPLING STRATEGY

The ADATE318 product is internally divided into a digital core and an analog core.

The VCC and DGND pins provide power and ground, respectively, for the digital core, which includes the SPI and all digital calibration functions. DGND is the logic ground reference for the VCC supply, and VCC should be adequately bypassed to DGND with low ESR bypass capacitors. To reduce transient digital switching noise coupling from the VCC and DGND pins to the analog core, DGND should be connected to a dedicated ground domain that is separate from the analog ground domains. If the application permits, the DGND should share digital ground domain with the system FPGA or ASIC that interfaces with the ADATE318 SPI. All CMOS inputs and outputs are referenced between VCC and DGND, and their valid levels should be guaranteed relative to these.

The analog core of the product includes all analog ATE functional blocks such as DACs, driver, comparator, load, PPMU, VHH driver, and so on. The VPLUS, VDD, and VSS supplies provide power for the analog core. The AGND and PGND are analog ground and analog power ground references, respectively. PGND is generally more noisy with analog switching transients, and it may also have large static dc currents. The AGND is generally more quiet and has relatively small static dc currents. Ideally, these ground domains should be separated, but it is not necessary. They can be connected together outside the chip to a shared analog ground plane. VDD and VSS should be adequately bypassed to the PGND ground domain. Both PGND and AGND (whether separated or shared) should be kept separate from the DGND ground plane as discussed above.

The VPLUS supply pin has the sole purpose to provide high voltage power for the VHH drive capability (HVOUT pin). If the VHH drive capability is used, the VPLUS supply must be provided as specified. If the VHH drive capability is not used, the VPLUS supply can be connected directly to the VDD supply domain to save power.

The ADATE318 also has a DUTGND input pin that can be used to sense the remote DUT ground potential. All DAC functions

(with the exception of VIOH and VIOL active load currents and VPMU when in PPMU FI mode) are adjusted relative to this DUTGND input. Further, the PPMU measure out pins (PPMU_MEASx) are referenced to DUTGND not AGND. This, therefore, requires the system ADC to reference its inputs relative to DUTGND as well. Referencing the system ADC to AGND results in errors, except in the case that DUTGND is tied to AGND. For applications that do not distinguish between DUT ground reference and system analog ground reference, the DUTGND pin can be connected to the same ground plane as AGND.

The ADATE318 should have ample supply decoupling of 0.1 μF on each supply pin located as close to the device as possible, ideally right up against the device. In addition, there should be one 10 μF tantalum capacitor shared across each power domain. The 0.1 μF capacitor should have low effective series resistance (ESR) and effective series inductance (ESL), such as the common ceramic capacitors that provide a low impedance path to ground at high frequencies to handle transient currents due to internal logic switching.

Digital lines running under the device should be avoided because these couple noise onto the device. The analog ground plane should be allowed to run under the device to avoid noise coupling. The power supply lines should use as large a trace as possible to provide low impedance paths and reduce the effects of glitches on the power supply line. Fast switching digital signals should be shielded with digital ground to avoid radiating noise to other parts of the board and should never be run near the reference inputs. It is essential to minimize noise on all VREF lines. Avoid crossover of digital and analog signals. Traces on opposite sides of the board should run at right angles to each other. This reduces the effects of feedthrough throughout the board. As is the case for all thin packages, care must be taken to avoid flexing the package and to avoid a point load on the surface of this package during the assembly process.

USER INFORMATION AND TRUTH TABLES

Table 25. Driver Truth Table¹

DCL Control Register Bits (0x19)						High Speed Inputs		Driver
DCL Enable ADDR 0x19[0]	Force Load ADDR 0x19[2]	Force Drive ADDR 0x19[1]	Force State ADDR 0x19[4:3]	Load Enable ADDR 0x19[5]	DRV_VT_HIZ ADDR 0x19 [6]	RCVx	DATx	
0	X	X	XX	X	X	X	X	Low leakage
1	X	1	00	X	X	X	X	VIL
1	X	1	01	X	X	X	X	VIH
1	X	1	10	X	X	X	X	High-Z
1	X	1	11	X	X	X	X	VIT
1	X	0	XX	X	X	0	0	VIL
1	X	0	XX	X	X	0	1	VIH
1	X	0	XX	X	0	1	X	High-Z
1	X	0	XX	X	1	1	X	VIT

¹X = don't care.Table 26. Active Load Truth Table¹

DCL Control Register Bits (0x19)						High Speed Inputs		Load
DCL Enable ADDR 0x19[0]	Force Load ADDR 0x19[2]	Force Drive ADDR 0x19[1]	Force State ADDR 0x19[4:3]	Load Enable ADDR 0x19[5]	DRV_VT_HIZ ADDR 0x19 [6]	RCVx	DATx	
0	X	X	XX	X	X	X	X	Low leakage
1	1	X	XX	X	X	X	X	Active on
1	0	X	XX	0	X	X	X	Low leakage
1	0	X	XX	1	X	0	X	Active off
1	0	X	XX	1	0	1	X	Active on
1	0	X	XX	1	1	1	X	Active off

¹X = don't care.Table 27. VHH and VIH/VIL Driver Truth Table¹

VHH_ENABLE ADDR 0x18[0]	CH0 RCV (RCV0)	CH0 DAT (DAT0)	Output of VHH Driver
1	0	0	VIL (Channel 0, VIL DAC)
1	0	1	VIH (Channel 0, VIH DAC)
1	1	X	VHH
0	X	X	Disabled (HVOUT pin set to 0.0 V, approximately 50 Ω impedance)

¹X = don't care.

Table 28. Comparator Truth Table

DMC ENABLE ADDR 0x1C[0]	CMPH0	CMPLO	CMPH1	CMPL1
0	Normal window compare mode Logic high: VOH0 < VDUT0 Logic low: VOH0 > VDUT0	Normal window compare mode Logic high: VOL0 < VDUT0 Logic low: VOL0 > VDUT0	Normal window compare mode Logic high: VOH1 < VDUT1 Logic low: VOH1 > VDUT1	Normal window compare mode Logic high: VOL1 < VDUT1 Logic low: VOL1 > VDUT1
1	Differential compare mode Logic high: VOH0 < VDUT0 – VDUT1 Logic low: VOH0 > VDUT0 – VDUT1	Differential compare mode Logic high: VOL0 < VDUT0 – VDUT1 Logic low: VOL0 > VDUT0 – VDUT1	Normal window compare mode Logic high: VOH1 < VDUT1 Logic low: VOH1 > VDUT1	Normal window compare mode Logic high: VOL1 < VDUT1 Logic low: VOL1 > VDUT1

ALARM FUNCTIONS

The ADATE318 contains per-channel overvoltage detectors (OVD), PPMU voltage/current clamps, and a per-chip thermal alarm to detect and signal fault conditions. The status of these circuits may be interrogated via the SPI by reading the alarm state register (SPI ADDR 0x1E; see Figure 124). This read-only register is cleared by a read operation. In addition, the fault conditions are combined in the fault alarm logic (see Figure 137) and drive the open drain ALARM pin to signal that a fault has occurred.

The various alarm circuits are controlled through the alarm mask register (ADDR 0x1D; see Figure 123). In the default state, the thermal alarm is enabled, and both the overvoltage alarm and the PPMU clamp alarms are masked off.

The only function of the alarm circuits is to detect and signal the presence of a fault. The only actions taken upon detection of a fault are setting of the appropriate register bit and activating the ALARM pin.

PPMU EXTERNAL CAPACITORS

Table 29. PPMU External Compensation and Feedforward Capacitors

External Components	Location
220 pF	Between FFCAPB0 and FFCAPA0
220 pF	Between FFCAPB1 and FFCAPA1
1000 pF	Between AGND and SCAPO
1000 pF	Between AGND and SCAP1

Table 30. Other External Components

External Components	Location
10 k Ω	ALARM pull-up to VCC
1 k Ω	BUSY pull-up to VCC

TEMPERATURE SENSOR

Table 31.

Temperature	Output
0 K	0.00 V
300 K	3.00 V
T _{KELVIN}	0.00 V + (T _{KELVIN}) × 10 mV/K

DEFAULT TEST CONDITIONS

Table 32.

Name	Default Test Condition
VIHx DAC Levels	2.0 V
VITx/VCOMx DAC Levels	1.0 V
VILx DAC Levels	0.0 V
VOHx DAC Levels	6.5 V
VOLx DAC Levels	-1.5 V
VCHx DAC Levels	7.5 V
VCLxDAC Levels	-2.5 V
VIOHxDAC Levels	0.0 mA
VIOLx DAC Levels	0.0 mA
PPMU_VINx DAC Levels	0.0 V
VHH DAC Level	13.0 V
OVDH DAC Levels	7.0 V
OVDL DAC Levels	-2.0 V
DAC_CONTROL	0x0000: DAC calibration disabled, DAC load mode is immediate
VHH_CONTROL	0x0000: HVOUT (VHH) disabled
DCL_CONTROL	0x0001: DCL enabled, load disabled, high-Z for RCVx = 1, force drive = 0 (to VIL state)
PPMU_CONTROL	0x0000: PPMU disabled, PPMU Range E, Force-V ¹ /Measure-V ² , input to V _{DUTGND} , internal sense path, clamps disabled, external PPMU_S open, PPMU_POWER_x off
PPMU_MEAS_CONTROL	0x0000: PPMU_MEASx high-Z
COMPARATOR_CONTROL	0x0000: normal window comparator mode, comparator hysteresis disabled
ALARM_MASK	0x0045: disable alarm functions
PRE_EMPHASIS_CONTROL	0x0000: disable driver CLC, differential comparator CLC, and normal window comparator CLC
Calibration m-Coefficients	1.0 (0xFFFF)
Calibration c-Coefficients	0.0 (0x8000)
DATx, RCVx Inputs	Logic low
DUTx Pins	Unterminated
CMPHx, CMPLx Outputs	Unterminated
V _{DUTGND}	0.0 V

¹ Force-V indicates force voltage.² Measure-V indicates measure voltage.

DETAILED FUNCTIONAL BLOCK DIAGRAMS

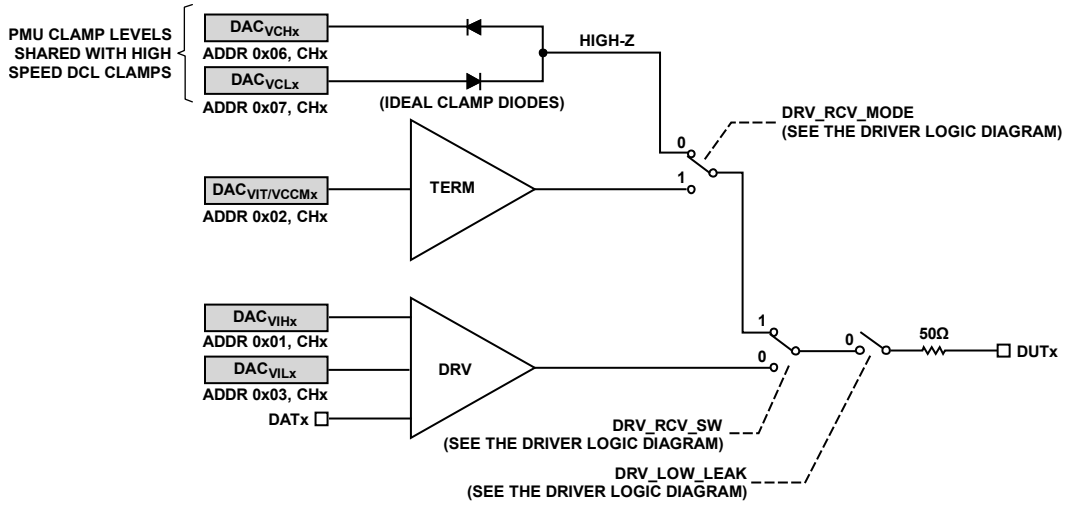

Figure 127. Driver Block Diagram

09530-023

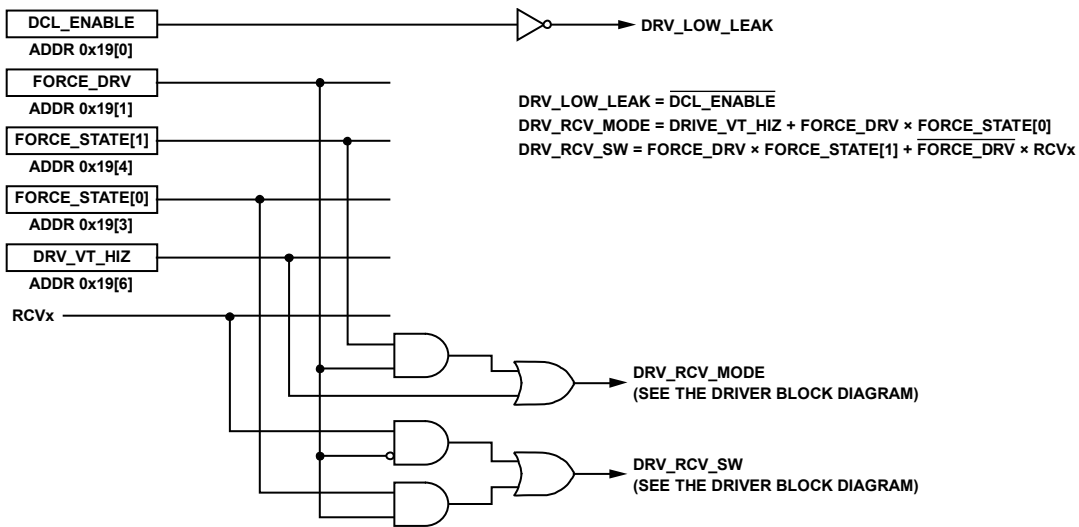

Figure 128. Driver Logic Diagram

09530-024

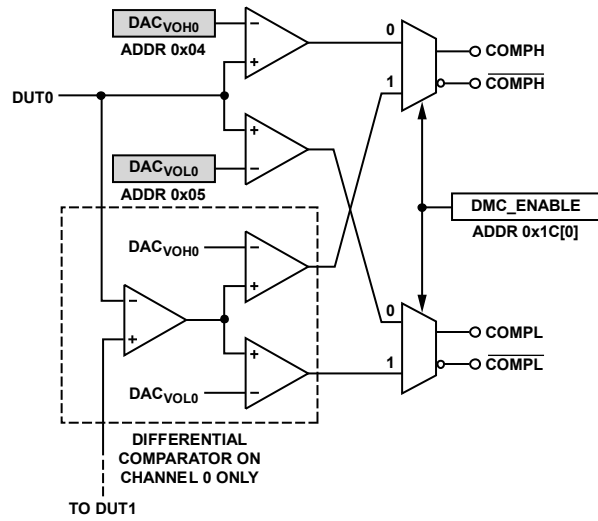

Figure 134. Comparator Block Diagram

09530-030

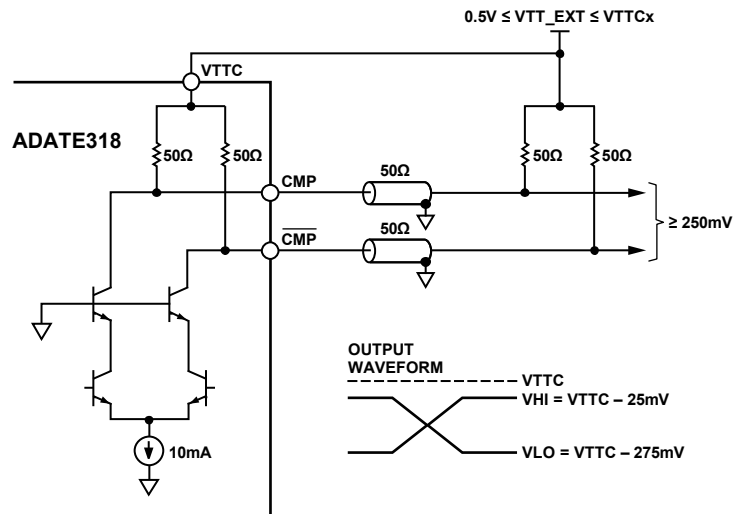

Figure 135. Comparator Output Stage Diagram

09530-031

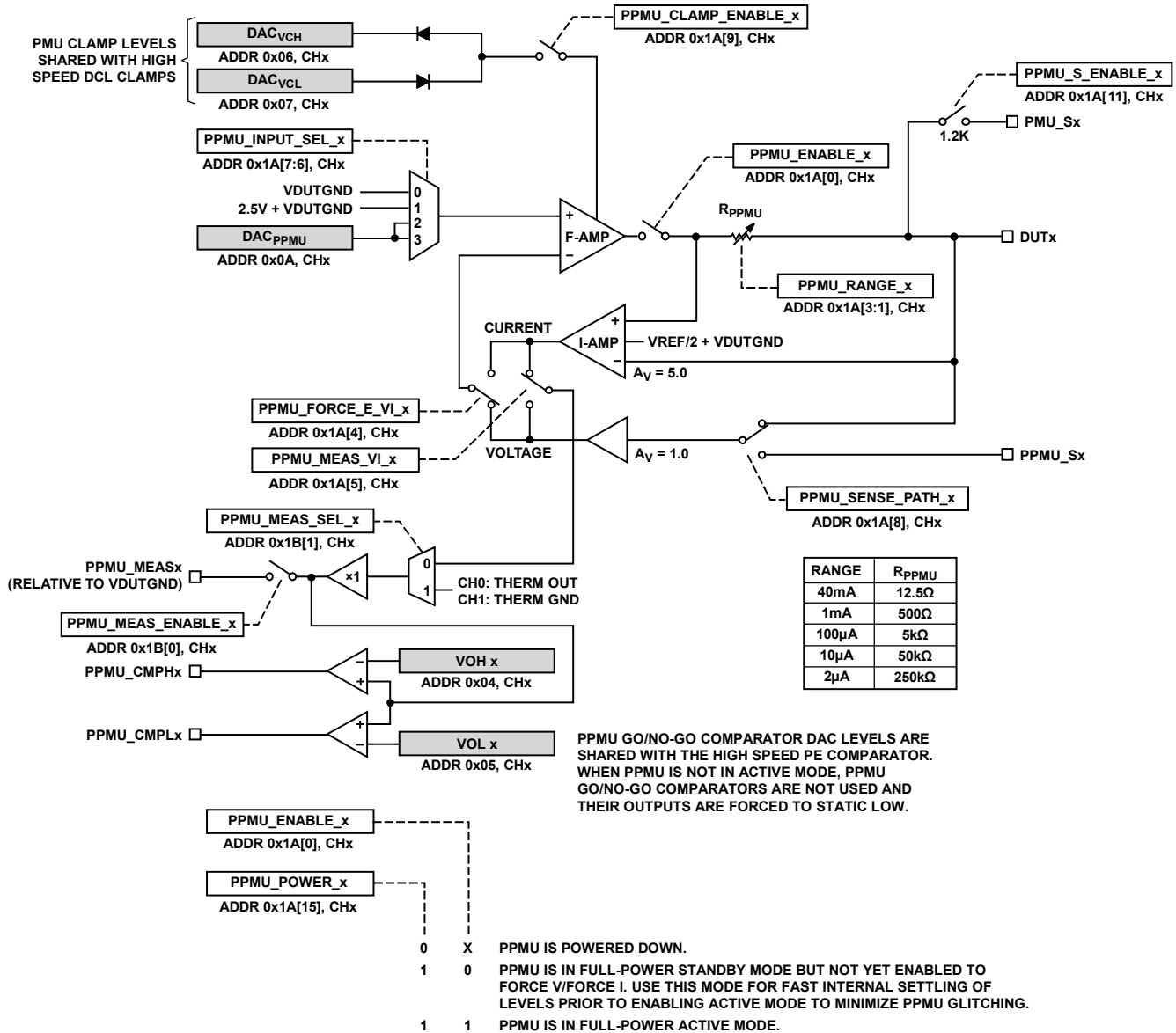

Figure 136. PPMU Block Diagram

09530-032

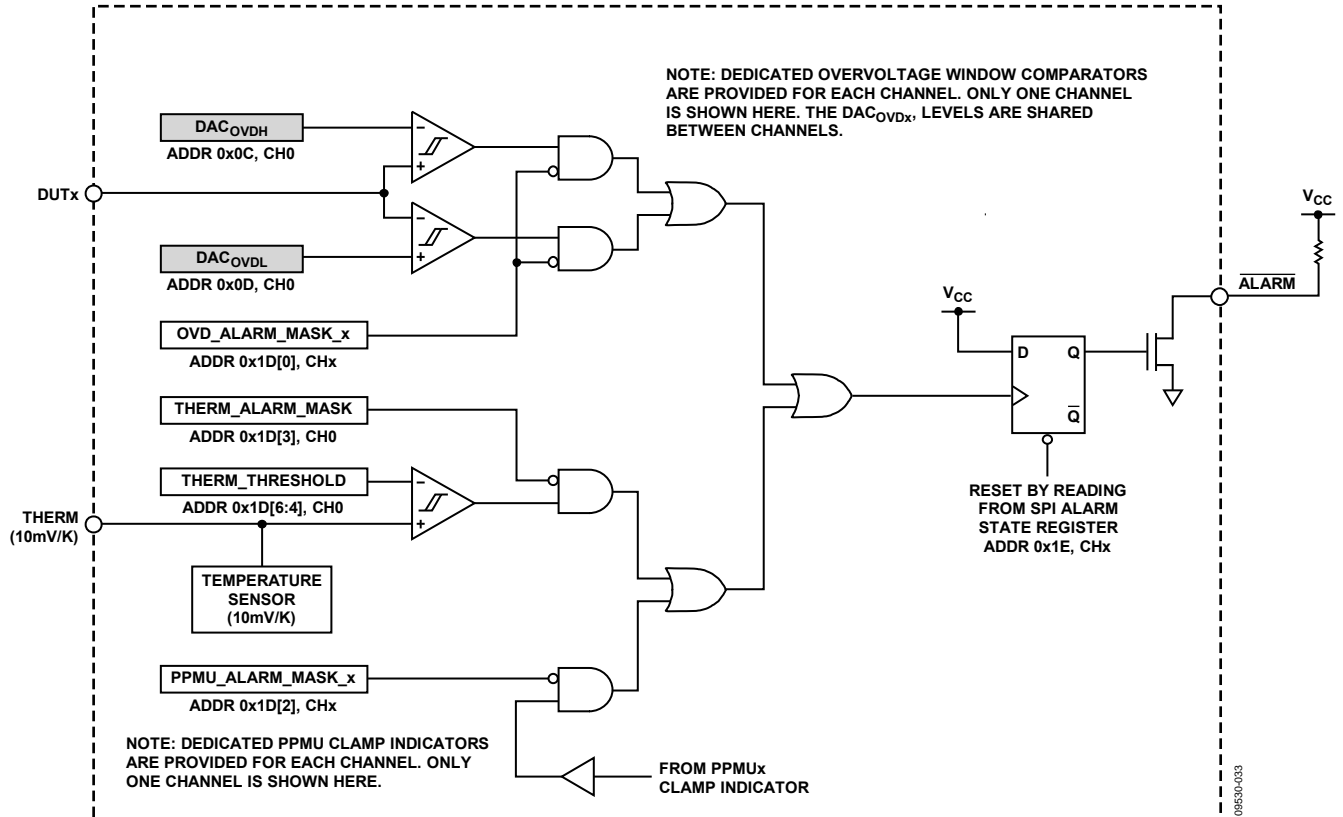
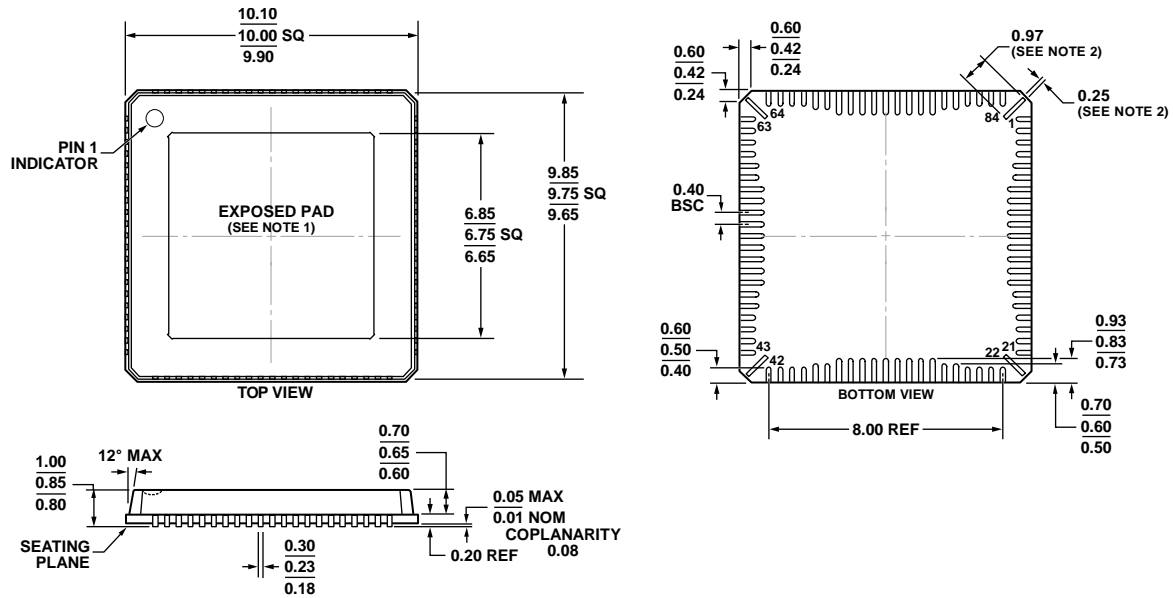

Figure 137. Fault Alarm Block Diagram

OUTLINE DIMENSIONS



- NOTES:
- FOR PROPER CONNECTION OF THE EXPOSED PAD, REFER TO THE PIN CONFIGURATION AND FUNCTION DESCRIPTIONS SECTION OF THIS DATA SHEET.
 - TIEBARS MAY OR MAY NOT BE SOLDERED TO THE BOARD.

Figure 138. 84-Lead Lead Frame Chip Scale Package [LFCSP]
 10 mm × 10 mm Body and 0.85 mm Package Height
 (CP-84-2)
 Dimensions shown in millimeters

07-02-2012-B

ORDERING GUIDE

Model ¹	Temperature Range	Package Description	Package Option
ADATE318BCPZ	T _J = +25°C to +70°C	84-Lead Lead Frame Chip Scale Package	CP-84-2

¹ Z = RoHS Compliant Part.

X-ON Electronics

Largest Supplier of Electrical and Electronic Components

Click to view similar products for [Special Purpose Amplifiers](#) category:

Click to view products by [Analog Devices](#) manufacturer:

Other Similar products are found below :

[LT6411CUD#PBF](#) [ADL5335ACPZN](#) [VCA8617PAGT](#) [LM359MX/NOPB](#) [PGA117AIPWR](#) [LMH6502MT/NOPB](#) [LTC6432AIUF-15#PBF](#)
[AD526AD](#) [AD526ADZ](#) [AD526BD](#) [AD526CDZ](#) [AD526JNZ](#) [AD526SD](#) [AD532JDZ](#) [AD532KHZ](#) [AD534KDZ](#) [AD534KHZ](#) [AD534LD](#)
[AD534LDZ](#) [AD534SD](#) [AD534TD](#) [AD539JDZ](#) [AD539JNZ](#) [AD539KDZ](#) [AD539KNZ](#) [AD600JNZ](#) [AD604ARSZ](#) [AD605ANZ](#) [AD605ARZ](#)
[AD605BRZ](#) [AD633ANZ](#) [AD633JNZ](#) [AD600JRZ-R7](#) [AD8018ARUZ](#) [AD8260ACPZ-WP](#) [AD8324ACPZ](#) [AD8330ACPZ-R2](#) [AD8330ACPZ-](#)
[R7](#) [AD8332ARUZ](#) [AD8334ACPZ](#) [AD8337BCPZ-REEL7](#) [AD8337BCPZ-WP](#) [AD8369ARUZ-REEL7](#) [AD8392AAREZ](#) [AD8375ACPZ-R7](#)
[AD8260ACPZ-R7](#) [AD8369ARUZ](#) [AD8398ACPZ-R2](#) [AD8331ARQZ](#) [AD8324JRQZ-REEL7](#)