

FEATURES

- Single axis, digital output MEMS vibration sensing module
- $\pm 50\text{ g}$ measurement range
- Ultralow output noise density, $26\ \mu\text{g}/\sqrt{\text{Hz}}$ (MTC mode)
- Wide bandwidth: dc to 10 kHz within 3 dB flatness (RTS mode)
- Embedded fast data conversion rate: 220 kSPS
- 6 digital FIR filters, 32 taps (coefficients), default options
 - High-pass filter cutoff frequencies: 1 kHz, 5 kHz, 10 kHz
 - Low-pass filter cutoff frequencies: 1 kHz, 5 kHz, 10 kHz
 - User configurable digital filter option (32 coefficients)
- Spectral analysis through internal FFT
 - Extended record length: 2048 bins with user configurable bin sizes from 0.42 Hz to 53.7 Hz
 - Manual or timer-based (automatic) triggering
 - Windowing options: rectangular, Hanning, flat top
 - FFT record averaging, configurable up to 255 records
 - Spectral defined alarm monitoring, 6 alarms
- Time domain capture with statistical metrics
 - Extended record length: 4096 samples
 - Mean, standard deviation, peak, crest factor, skewness, and Kurtosis
- Configurable alarm monitoring
- Real-time data streaming at 220 kSPS
 - Burst mode communication with CRC-16 error checking
- Storage: 10 data records
- On demand self test with status flags
- Sleep mode with external and timer driven wakeup
- Digital temperature and power supply measurements
- SPI-compatible serial interface
- Identification registers: factory preprogrammed serial number, device ID, user programmable ID
- Single-supply operation: 3.0 V to 3.6 V
- Operating temperature range: -40°C to $+105^{\circ}\text{C}$
 - Automatic shutdown at 125°C (junction temperature)
- 23.7 mm \times 27.0 mm \times 12.4 mm aluminum package
 - 36 mm flexible, 14-lead module with integrated flexible connector
 - Mass: 13 g

APPLICATIONS

- Vibration analysis
- Condition-based monitoring (CbM) systems
- Machine health
- Instrumentation and diagnostics
- Safety shutoff sensing

FUNCTIONAL BLOCK DIAGRAM

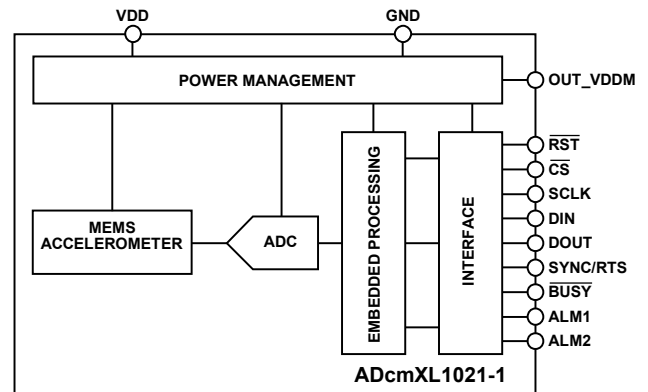

Figure 1.

GENERAL DESCRIPTION

The ADcmXL1021-1 is a complete vibration sensing system that combines high performance vibration sensing (using a micro-electromechanical systems (MEMS) accelerometer) with a variety of signal processing functions to simplify the development of smart sensor nodes in condition-based monitoring (CBM) systems. The typical ultralow noise density ($26\ \mu\text{g}/\sqrt{\text{Hz}}$) in the MEMS accelerometers supports excellent resolution. The wide bandwidth (dc to 10 kHz within 3 dB flatness) enables tracking of key vibration signatures on many machine platforms.

The signal processing includes high speed data sampling (220 kSPS), 4096 time sample record lengths, filtering, windowing, fast Fourier transform (FFT), user configurable spectral or time statistic alarms, and error flags. The serial peripheral interface (SPI) provides access to a register structure that contains the vibration data and a wide range of user configurable functions.

The ADcmXL1021-1 is available in a 23.7 mm \times 27.0 mm \times 12.4 mm aluminum package with four mounting flanges to support installation with standard machine screws. This light weight package (13 g) provides consistent mechanical coupling to the core sensors over a broad frequency range. The electrical interface is through a 14-lead connector on a 36 mm flexible cable, which enables a wide range of location and orientation options for system mating connectors.

The ADcmXL1021-1 requires only a single, 3.3 V power supply and supports an operating temperature range of -40°C to $+105^{\circ}\text{C}$.

Multifunction pin names may be referenced by their relevant function only.

TABLE OF CONTENTS

Features	1	REC_CTRL, Recording Control	31
Applications.....	1	REC_PRD, Record Period.....	32
Functional Block Diagram	1	ALM_F_LOW, Alarm Frequency Band	33
General Description	1	ALM_F_HIGH, Alarm Frequency Band	33
Revision History	2	ALM_MAG1, Alarm Level 1	33
Specifications.....	3	ALM_MAG2, Alarm Level 2	33
Timing Specifications	4	ALM_PNTR, Alarm Pointer.....	34
Absolute Maximum Ratings.....	6	ALM_S_MAG Alarm Level.....	34
Thermal Resistance	6	ALM_CTRL, Alarm Control	34
ESD Caution.....	6	FILT_CTRL, Filter Control.....	34
Pin Configuration and Function Descriptions.....	7	AVG_CNT, Decimation Control.....	35
Typical Performance Characteristics	8	DIAG_STAT, Status, and Error Flags.....	35
Theory of Operation	11	GLOB_CMD, Global Commands.....	36
Core Sensors.....	11	ALM_STAT, Alarm Status.....	36
Signal Processing.....	11	ALM_PEAK, Alarm Peak Level.....	36
Modes of Operation	12	TIME_STAMP_L and TIME_STAMP_H, Data Record Timestamp.....	36
Data Recording Options.....	13	DAY_REV, Day and Revision	37
User Interface	16	YEAR_MON, Year and Month.....	37
Basic Operation.....	19	PROD_ID, Product Identification	37
Device Configuration	19	SERIAL_NUM, Serial Number	37
Dual Memory Structure	19	USER_SCRATCH	37
Power-Up Sequence	19	REC_FLASH_CNT, Record Flash Endurance	37
Trigger.....	19	MISC_CTRL, Miscellaneous Control	37
Sample Rate	20	REC_INFO1, Record Information.....	38
Datapath Processing.....	20	REC_INFO2, Record Information.....	38
Spectral Alarms.....	22	REC_CNTR, Record Counter	38
Mechanical Mounting Recommendations.....	22	ALM_FREQ, Severe Alarm Frequency	38
User Register Memory Map	23	STAT_PNTR, Statistic Result Pointer.....	38
User Register Details	28	STATISTIC, Statistic Result	39
PAGE_ID, Page Number	28	FUND_FREQ, Fundamental Frequency.....	39
TEMP_OUT, Internal Temperature.....	28	FLASH_CNT_L, Flash Memory Endurance	39
SUPPLY_OUT, Power Supply Voltage.....	28	FLASH_CNT_U, Flash Memory Endurance	39
FFT_AVG1, Spectral Averaging	28	FIR Filter Registers.....	40
FFT_AVG2, Spectral Averaging	29	Applications Information	41
BUF_PNTR, Buffer Pointer	29	Mechanical Interface.....	41
REC_PNTR, Record Pointer.....	30	Outline Dimensions	42
OUT_BUE, Buffer Access Register.....	30	Ordering Guide	42
ANULL, Bias Calibration Register.....	31		

REVISION HISTORY

11/2019—Revision 0: Initial Version

SPECIFICATIONS

$T_A = 25^\circ\text{C}$ and $V_{DD} = 3.3\text{ V}$, unless otherwise noted.

Table 1.

Parameter	Test Conditions/Comments	Min	Typ	Max	Unit
ACCELEROMETERS					
Measurement Range ¹			±50		g
Sensitivity			0.9535		mg/LSB
FFT			1.907		mg/LSB
Time Domain			±5		%
Error over Temperature			±0.2	±1.25	%
Nonlinearity	Best fit, straight line, full scale (FS) = ±50 g		2		%
Cross Axis Sensitivity			2		%
Alignment Error	With respect to package		2		Degrees
Offset Error Over Temperature	$T_A = -40^\circ\text{C}$ to $+105^\circ\text{C}$		±5		g
Offset Temperature Coefficient	$T_A = -40^\circ\text{C}$ to $+105^\circ\text{C}$		34		mg/°C
Output Noise	Real-time streaming (RTS) mode		3.2		mg rms
Output Noise Density	100 Hz to 10 kHz, AVG_CNT = 0, MTC mode		26		μg/√Hz
	1 Hz to 10 kHz, no filtering, RTS mode		32		μg/√Hz
3 dB Bandwidth		10,000			Hz
Sensor Resonant Frequency			21		kHz
CONVERSION RATE					
Clock Accuracy			3	220	kSPS %
FUNCTIONAL TIMING					
Factory Reset Time Recovery			126		ms
Start-Up Time	Time from supply voltage reaching 3.0 V from power-down until ready for command		205		ms
Self Test Time			92		ms
LOGIC INPUTS					
Input High Voltage, V_{IH}		2.5			V
Input Low Voltage, V_{IL}				0.45	V
Logic 1 Input Current, I_{IH}	$V_{IH} = 3.3\text{ V}$		0.01	0.2	μA
Logic 0 Input Current, I_{IL}	$V_{IL} = 0\text{ V}$			100	μA
All Except $\overline{\text{RST}}$					μA
$\overline{\text{RST}}$			1		mA
Input Capacitance, C_{IN}			10		pF
DIGITAL OUTPUTS					
Output Voltage					
High, V_{OH}	$I_{OH} = -1\text{ mA}$	1.4			V
Low, V_{OL}	$I_{OL} = 1\text{ mA}$			0.4	V
Output Current					
High, I_{OH}	$I_{OH} = -1\text{ mA}$			2	mA
Low, I_{OL}	$I_{OL} = 1\text{ mA}$			2	mA
FLASH MEMORY					
Endurance ²		10,000			Cycles
Data Retention ³	$T_J = 85^\circ\text{C}$, see Figure 44		10		Years
THERMAL SHUTDOWN					
Threshold	T_J rising		125		°C
Hysteresis			15		°C
OUT_VDDM MONITOR OUTPUT					
Output Resistance	Logic output, logic high indicates good condition Logic low when internal temperature exceeds allowed range	90	100	110	kΩ

Parameter	Test Conditions/Comments	Min	Typ	Max	Unit
POWER SUPPLY VOLTAGE	Operating voltage range, VDD	3.0	3.3	3.6	V
Power Supply Current	Operating mode, VDD = 3.0 V		22.9		mA
	Operating mode, VDD = 3.3 V		23.2		mA
	Operating mode, VDD = 3.6 V		23.9		mA
	Sleep mode, VDD = 3.0 V		0.1		mA
	Sleep mode, VDD = 3.3 V		0.6		mA
	Sleep mode, VDD = 3.6 V		1.5		mA

¹ The maximum range depends on the frequency of the vibration.

² Endurance is qualified as per JEDEC Standard 22, Method A117 and measured at -40°C, +25°C, +85°C, and +125°C.

³ Retention lifetime equivalent at junction temperature (T_j) = 85°C as per JEDEC Standard 22, Method A117. Retention lifetime depends on T_j.

TIMING SPECIFICATIONS

T_c = 25°C and VDD = 3.3 V, unless otherwise noted.

Table 2.

Parameter	Description	Normal Mode			RTS Mode			Unit
		Min ¹	Typ	Max ¹	Min	Typ	Max ¹	
f _{SCLK}	SCLK frequency	0.01		14	8		14	MHz
t _{STALL}	Stall period between data bytes	16				N/A ²		µs
t _{CLS}	SCLK low period	35.7			35.7			ns
t _{CHS}	SCLK high period	35.7			35.7			ns
t _{CS}	CS to SCLK edge	35.7			35.7			ns
t _{DAV}	DOUT valid after SCLK edge			20			20	ns
t _{DSU}	DIN setup time before SCLK rising edge	6			6			ns
t _{DHD}	DIN hold time after SCLK rising edge	8			8			ns
t _{DSOE}	CS assertion to DOUT active			20	0		20	ns
t _{HD}	SCLK edge to DOUT invalid			20			20	ns
t _{SFS}	Last SCLK edge to CS deassertion	35.7			35.7			ns
t _{RTS_BUSY}	RTS mode only, data out valid burst readout period ends before BUSY rising edge for next burst		N/A ²		12			µs

¹ Guaranteed by design and characterization, but not tested in production.

² N/A means not applicable. When using real-time streaming (RTS), the stall period is not applicable.

Timing Diagrams

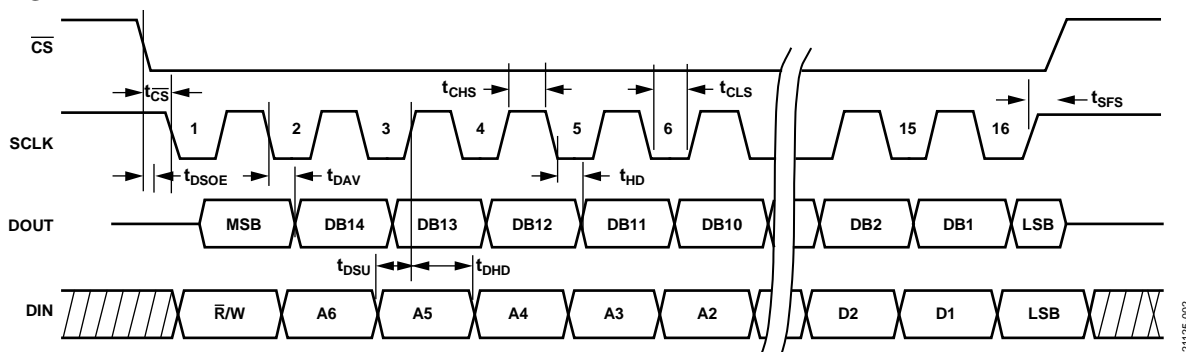

Figure 2. SPI Timing and Sequence

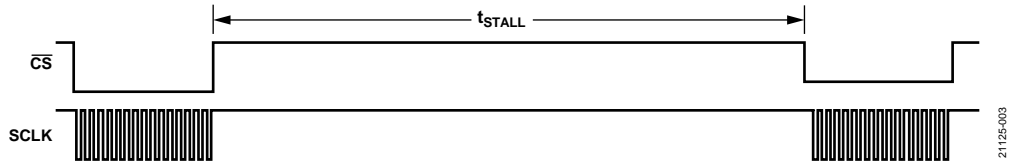
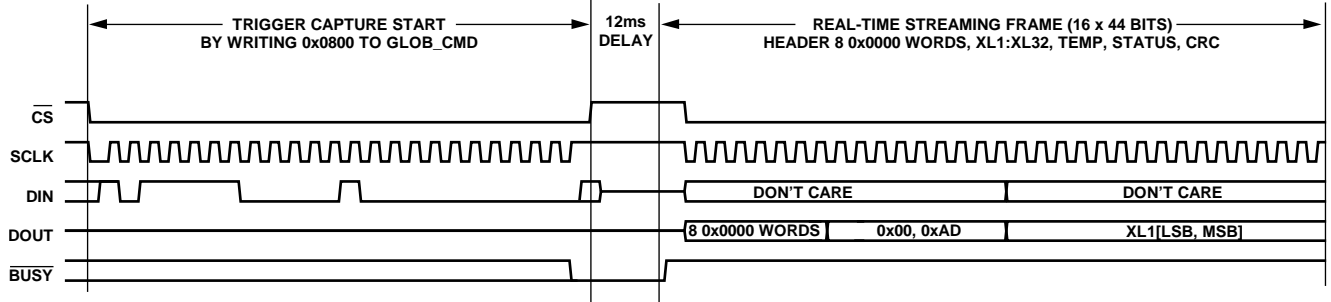
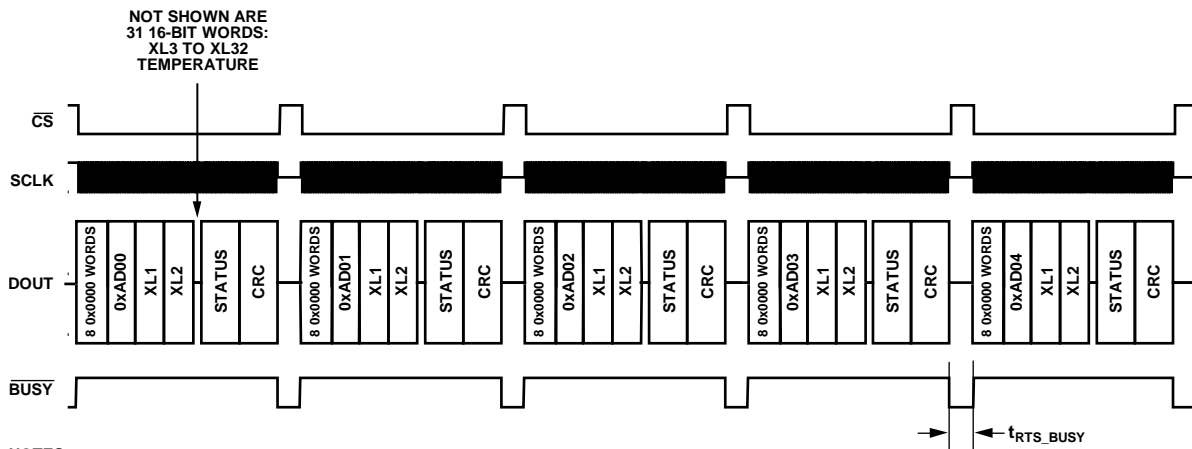

Figure 3. Stall Time (Does Not Apply to RTS Mode)



NOTES
1. XLx IS ACCELEROMETER DATA; TEMP IS TEMPERATURE DATA.

Figure 4. RTS Mode Timing Diagram, Assumes REC_CTRL, Bits[1:0] = 0b11 (See Table 17)



NOTES
1. XLx IS ACCELEROMETER DATA.

Figure 5. RTS Read Function Sequence Diagram, First Five Segments (See Table 17)

ABSOLUTE MAXIMUM RATINGS

Table 3.

Parameter	Rating
Acceleration	
Unpowered	2000 <i>g</i>
Powered	2000 <i>g</i>
VDD to GND	−0.3 V to +3.6 V
Digital Input Voltage to GND	−0.3 V to +3.6 V
Digital Output Voltage to GND	−0.3 V to +3.6 V
Temperature Range	
Operating Temperature	−40°C to +105°C
Storage Temperature	−65°C to +150°C

Stresses at or above those listed under Absolute Maximum Ratings may cause permanent damage to the product. This is a stress rating only; functional operation of the product at these or any other conditions above those indicated in the operational section of this specification is not implied. Operation beyond the maximum operating conditions for extended periods may affect product reliability.

THERMAL RESISTANCE

Thermal performance is directly linked to printed circuit board (PCB) design and operating environment. Pay careful attention to PCB thermal design.

θ_{JA} is the natural convection, junction to ambient thermal resistance measured in a one cubic foot sealed enclosure.

θ_{JC} is the junction to case thermal resistance.

The ADcmXL1021-1 is a multichip module that includes many active components. The values in Table 4 identify the thermal response of the hottest component inside of the ADcmXL1021-1 with respect to the overall power dissipation of the module. This approach enables a simple method for predicting the temperature of the hottest junction based on either ambient or case temperature.

For example, when $T_A = 70^\circ\text{C}$, under normal operation mode with a typical 23.2 mA current and 3.3 V supply voltage, the hottest junction temperature in the ADcmXL1021-1 is 75.0°C.

$$T_J = \theta_{JA} \times VDD \times I_{DD} + 70^\circ\text{C}$$

$$T_J = 65.1^\circ\text{C/W} \times 3.3 \text{ V} \times 0.0232 \text{ A} + 70^\circ\text{C}$$

$$T_J \approx 75.0^\circ\text{C}$$

where I_{DD} is the current consumption of the device.

Table 4. Thermal Resistance

Package Type	θ_{JA}	θ_{JC}
ML-14-7 ¹	65.1°C/W	33.2°C/W

¹ Thermal impedance simulated values come from a case with four machine screws at a size of M2.5 × 0.4 mm (torque = 25 inch pounds). Secure the ADcmXL1021-1 to the PCB.

ESD CAUTION



ESD (electrostatic discharge) sensitive device.

Charged devices and circuit boards can discharge without detection. Although this product features patented or proprietary protection circuitry, damage may occur on devices subjected to high energy ESD. Therefore, proper ESD precautions should be taken to avoid performance degradation or loss of functionality.

PIN CONFIGURATION AND FUNCTION DESCRIPTIONS

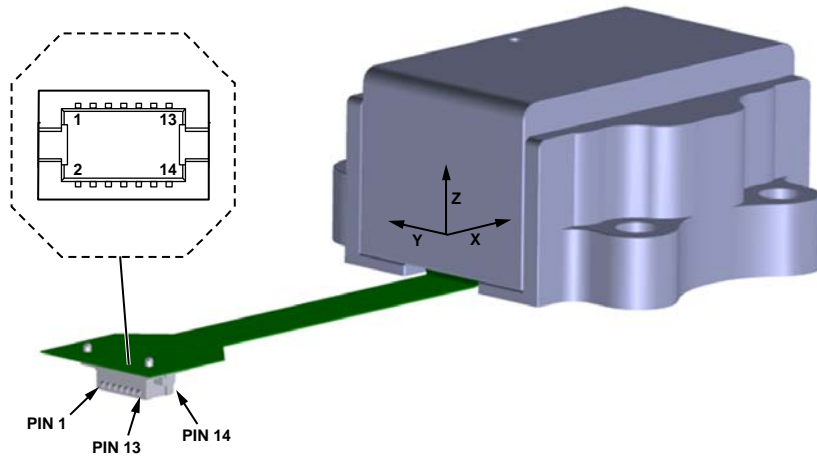

Figure 6. Pin Configuration

21125-007

Table 5. Pin Function Descriptions

Pin No.	Mnemonic	Type	Description
1	GND	Supply	Ground.
2	ALM1	Output	Digital Output Only, Alarm 1 Output. This pin is configured by the ALM_CTRL register and is not used in RTS mode.
3	SYNC/RTS	Input	Sync Function (SYNC)/RTS Burst Start/Stop (RTS). This pin is a digital input only and is edge (not level) sensitive. This pin must be enabled in the MISC_CTRL register (Bit 12) before being used as an external trigger. The SYNC pulse width must be at least 50 ns. In MTC and MFFT modes, the SYNC pin acts as a manual trigger, this pin initiates a record capture event when a low to high transition is detected, equivalent to SPI Command 0x0800 to the GLOB_CMD register. In RTS and AFFT mode, when the logic level on this pin is high, conversion is active. When the logic level on this pin is low, conversion is stopped after the current data record is completed.
4	ALM2	Output	Digital Output Only, Alarm 2 Output. This pin is configured by the ALM_CTRL register and is not used in RTS mode.
5	$\overline{\text{BUSY}}$	Output	Busy or Data Ready Indicator, Digital Output Only. In RTS mode, this pin is a logical output to indicate that data is ready and available for download. The logical state resets to logic low when data is loading to the output buffers. The pin is set high when data is ready for download. In other capture modes, the busy indicator identifies the state of the module processor and if it is available for external commands. When a command is executing, SPI access is not allowed, and the device is in a busy state. After this process completes, whether a command or a record, the SPI is released, and the $\overline{\text{BUSY}}$ pin is set to logic high state. Note that there is one exception to SPI port access while in the busy state, a capture can be terminated by writing the unique 16-bit escape code, 0x00E8, to the GLOB_CMD register.
6	OUT_VDDM	Output	Power Supply Monitor (Digital Output). This pin is logic low when temperature exceeds threshold and automatic shutdown occurs.
7	$\overline{\text{RST}}$	Input	Hardware Reset, Digital Input Only, Active Low. This pin enters the device in a known state by resetting the microcontroller. This pin also loads the user configurable parameters from flash memory.
8	VDD	Supply	Power Supply.
9	GND	Supply	Ground.
10	GND	Supply	Ground.
11	DIN	Input	SPI, Data Input Line.
12	DOUT	Output	SPI, Data Output. DOUT is an output when $\overline{\text{CS}}$ is low. When $\overline{\text{CS}}$ is high, DOUT is in a three-state, high impedance mode.
13	SCLK	Input	SPI, Serial Clock.
14	$\overline{\text{CS}}$	Input	SPI, Chip Select.

TYPICAL PERFORMANCE CHARACTERISTICS

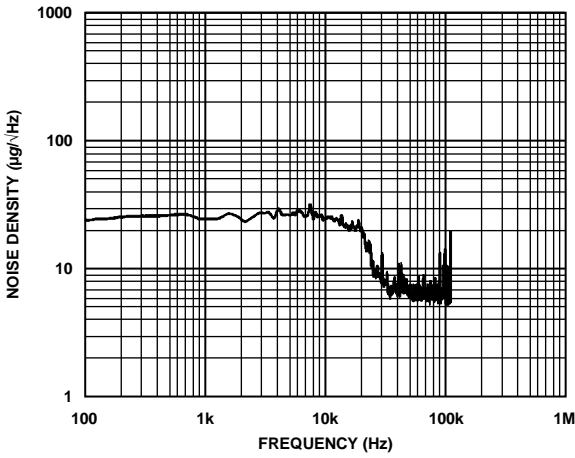

Figure 7. Noise Density, Wideband, MTC, AVG_CNT = 0

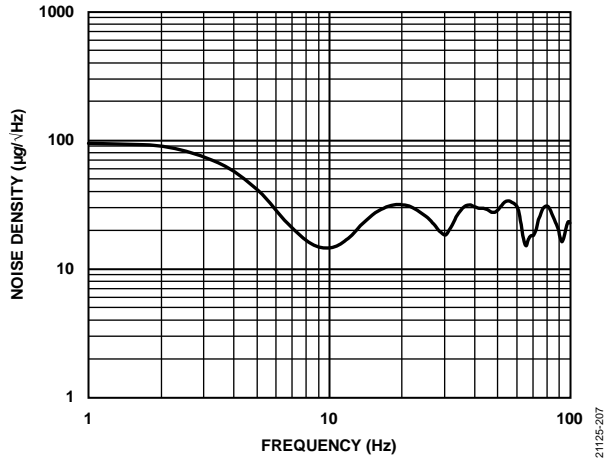

Figure 10. Noise Density, Low Frequency, RTS Mode

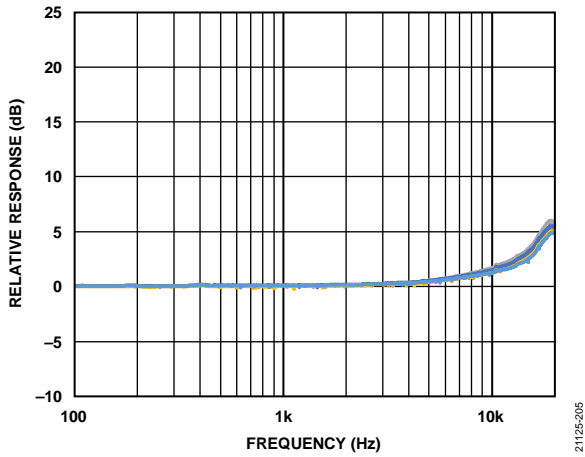

Figure 8. Relative Response, RTS Mode at 25°C

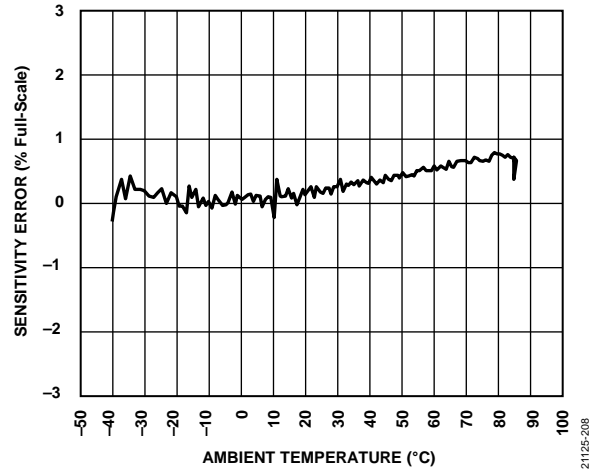

Figure 11. Sensitivity Error vs. Ambient Temperature, Normalized at 25°C

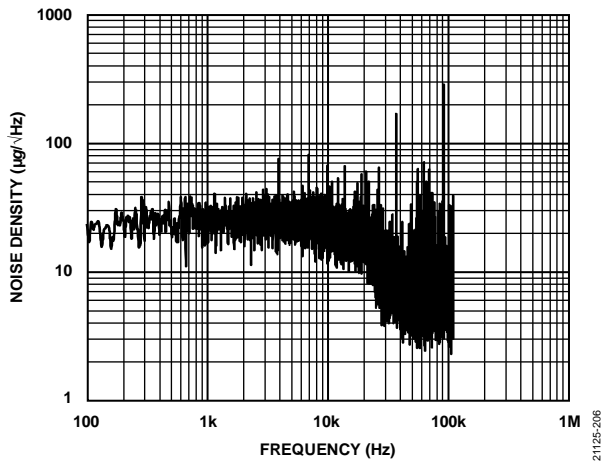

Figure 9. Noise Density, Wideband, RTS Mode

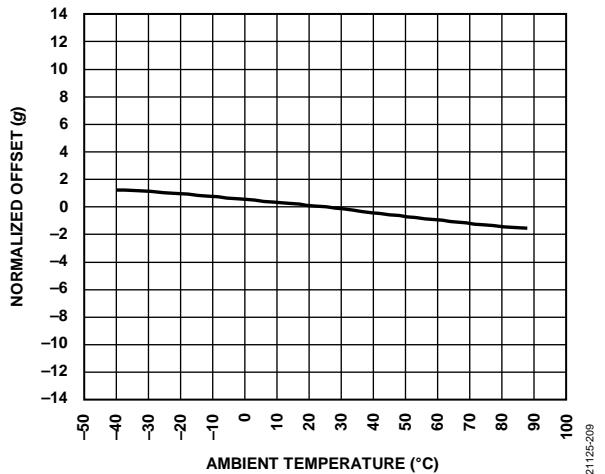

Figure 12. Normalized Offset vs. Ambient Temperature, Normalized at 25°C

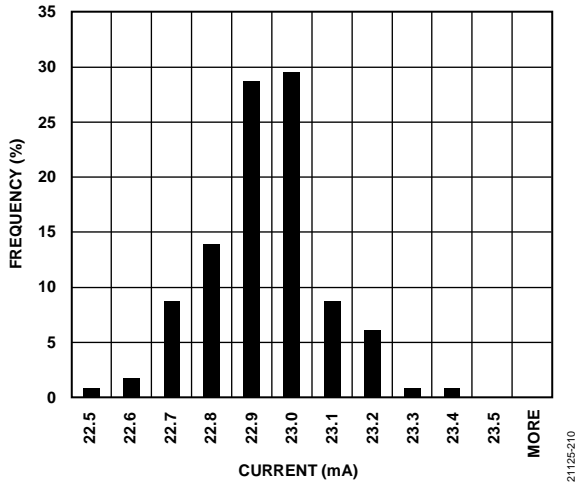

Figure 13. Operating Mode Current Distribution at 3.0 V Supply

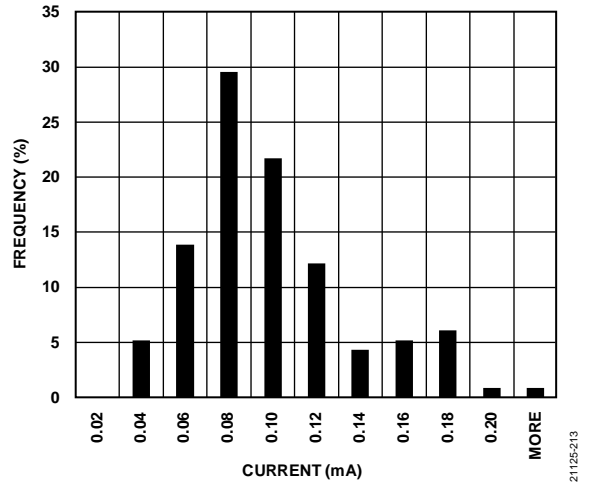

Figure 16. Sleep Mode Current Distribution at 3.0 V Supply

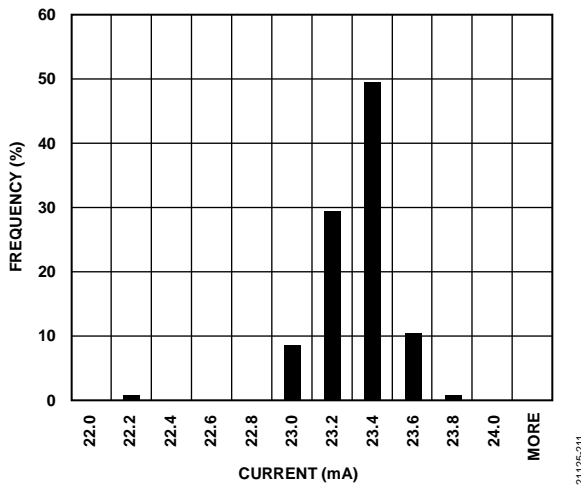

Figure 14. Operating Mode Current Distribution at 3.3 V Supply

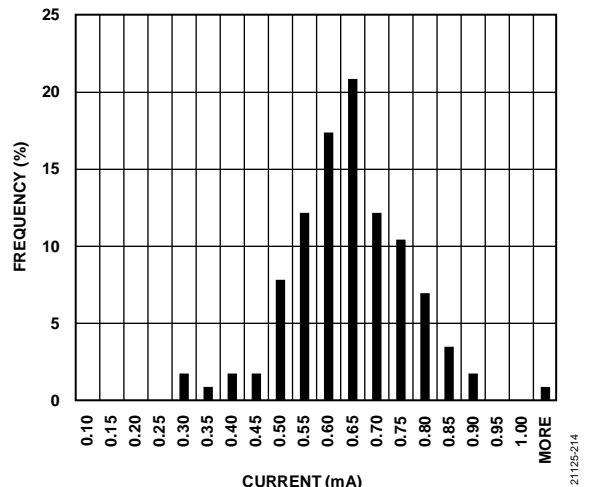

Figure 17. Sleep Mode Current Distribution at 3.3 V Supply

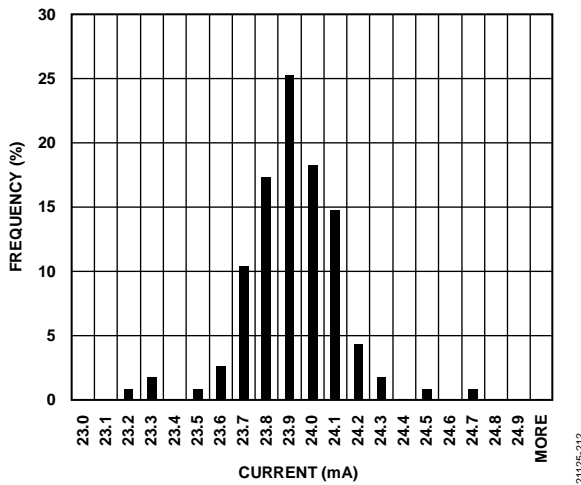

Figure 15. Operating Mode Current Distribution at 3.6 V Supply

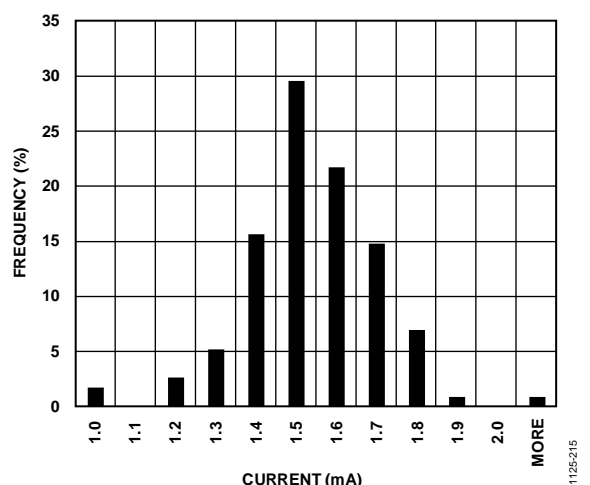

Figure 18. Sleep Mode Current Distribution at 3.6 V Supply

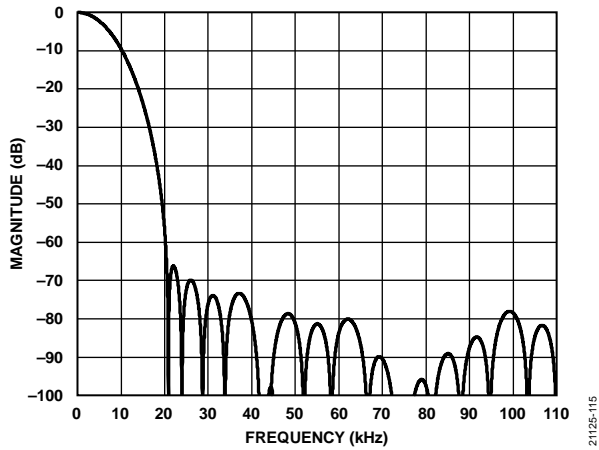

Figure 19. Digital Filter Frequency Response of the 1 kHz Low-Pass Filter

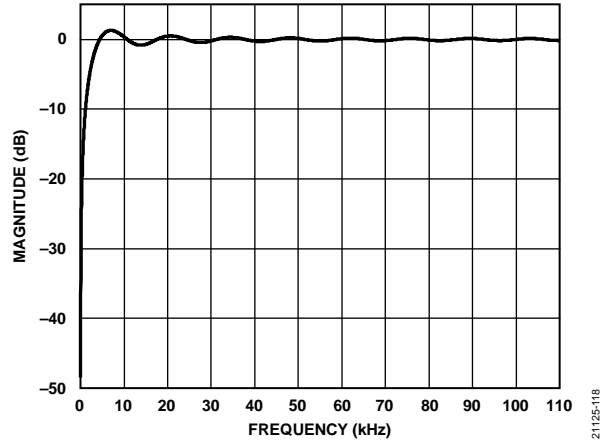

Figure 22. Digital Filter Frequency Response of the 1 kHz High-Pass Filter

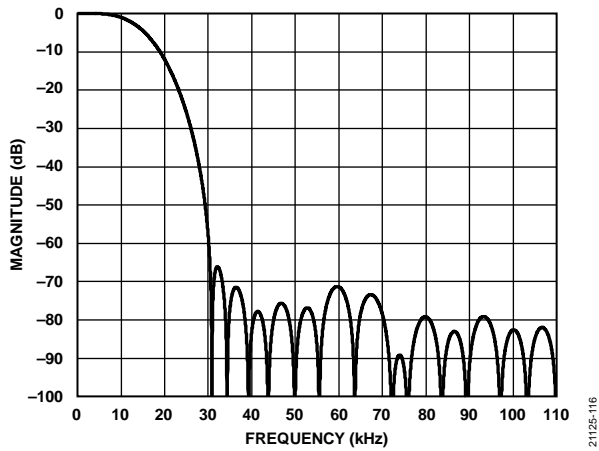

Figure 20. Digital Filter Frequency Response of the 5 kHz Low-Pass Filter

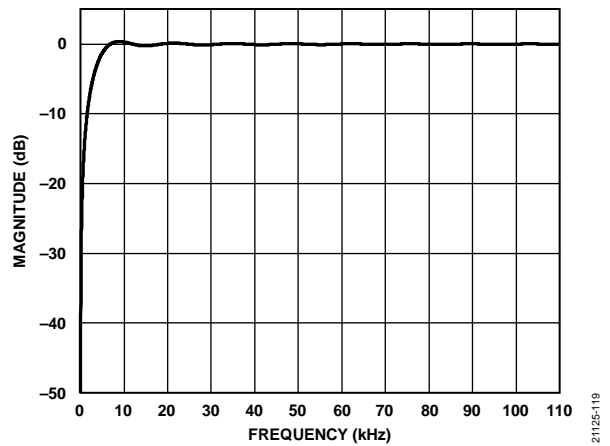

Figure 23. Digital Filter Frequency Response of the 5 kHz High-Pass Filter

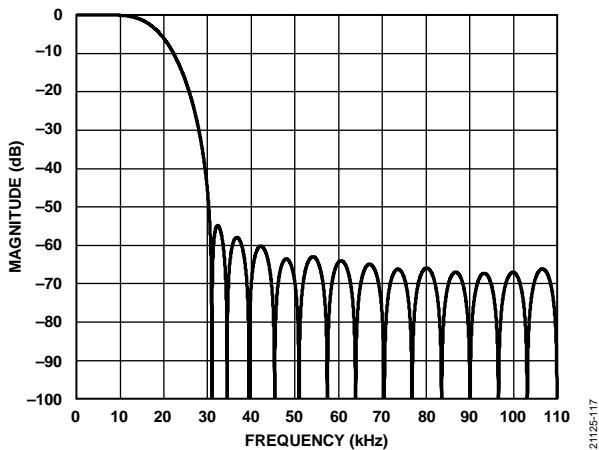

Figure 21. Digital Filter Frequency Response of the 10 kHz Low-Pass Filter

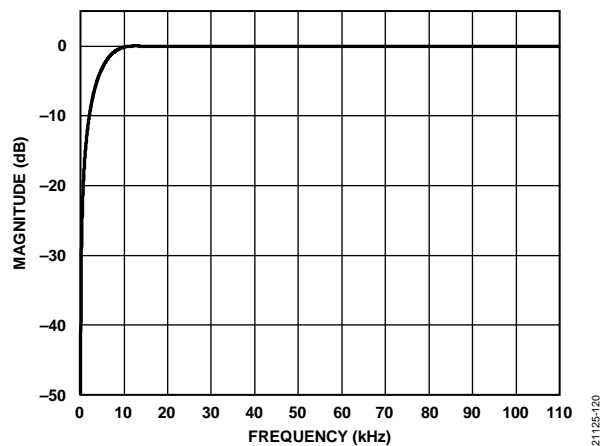

Figure 24. Digital Filter Frequency Response of the 10 kHz High-Pass Filter

THEORY OF OPERATION

The ADcmXL1021-1 is a single axis, vibration monitoring subsystem that includes a wide bandwidth, low noise MEMS accelerometer, an analog-to-digital converter (ADC), high performance signal processing, data buffers, record storage, and a user interface that easily interfaces with most embedded processors. See Figure 25 for a basic signal chain. The subsystem is housed in an aluminum module that is mounted using four screws (accepts screw size M2.5) and is designed to be mechanically stable beyond 40 kHz. The combination of this mechanical mounting and oversampling ensures that aliasing artifacts are minimized.

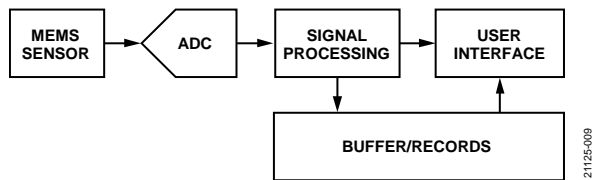

Figure 25. Basic Signal Chain

The ADcmXL1021-1 has a high operating input range of $\pm 50 g$ and is suitable for vibration measurements in high bandwidth applications, such as vibration analysis systems that monitor and diagnose machine or system health. User configurable internal processing supports both time domain and frequency domain calculations.

The low noise and high frequency bandwidth enable the measurement of both repetitive vibration patterns and single shock events caused by small moving parts, such as internal bearings. The high g range provides the dynamic range used in high vibration environments, such as heating, ventilation, and air conditioning systems (HVAC), and heavy machine equipment. To achieve best performance, be aware of system noise, mounting, and signal conditioning for the particular application.

Proper mounting is required to ensure full mechanical transfer of vibration to accurately measure the desired vibration. A common technique for high frequency mechanical coupling is to use a combination of a threaded screw mount system and adhesive where possible. For lower frequencies (below the full capable bandwidth of the sensor), it is possible to use magnetic or adhesive mounting. Proper mounting techniques ensure accurate and repeatable results that are not influenced by measurement system mechanical resonances and/or damping at the desired frequencies and represents an efficient and proper mechanical transfer to the system being monitored.

CORE SENSORS

The ADcmXL1021-1 uses one [ADXL1002](#) MEMS accelerometer, with the sensing axis aligned with the axis of interest. Figure 26 is a simple mechanical diagram that shows how MEMS accelerometers translate linear acceleration to representative output signals.

The moving component of the sensor is a polysilicon surface-micromachined structure built on top of a silicon wafer. Polysilicon springs suspend the structure over the surface of the wafer and provide a resistance against acceleration forces.

Deflection of the structure is measured using differential capacitors that consist of independent fixed plates and plates attached to the moving mass. Acceleration deflects the structure and unbalances the differential capacitor, resulting in a sensor output with an amplitude proportional to acceleration. Phase sensitive demodulation determines the magnitude and polarity of the acceleration.

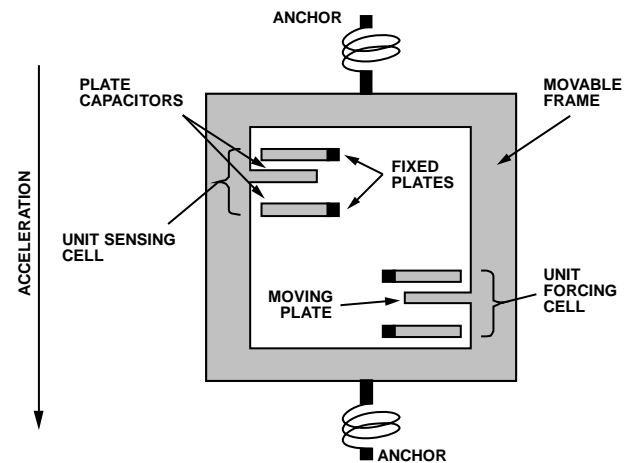

Figure 26. MEMS Sensor Diagram

SIGNAL PROCESSING

The signal chain of the ADcmXL1021-1 includes a wideband accelerometer, a low-pass analog filter with a 13.5 kHz cutoff frequency, an oversampling ADC (sampling at 220 kSPS), a microcontroller, and discrete components to provide a flexible vibration monitor subsystem that supports multiple processed output modes. There are four modes of operation. One mode of operation is the full rate RTS output. The three other modes include system level signal processing: manual FFT mode (MFFT), automatic FFT mode (AFFT), and manual time capture (MTC) mode

MTC mode supports 4096 consecutive time domain samples to which averaging, finite impulse response (FIR), and windowing signal processing can be enabled, along with the calculation of statistics, alarm configuring, and monitoring. In MTC mode, the raw time domain data is made available in register buffers for the user to access and externally process.

In both FFT modes, MFFT and AFFT modes support the process of calculating an FFT of the current time domain record.

A continuous RTS mode bypasses all device digital computations and alarm monitoring, outputting real-time data over the SPI in burst data output format (see Figure 5).

MODES OF OPERATION

The ADcmXL1021-1 supports four different modes of operation: RTS, MTC, MFFT, and AFFT. Users can select the mode of operation by writing the corresponding code to the REC_CTRL register, Bits[1:0] (see Table 47).

In three of these modes (MFFT, AFFT, and MTC), the ADcmXL1021-1 captures, analyzes, and stores vibration data in discrete events, known as capture events, and generates a record. Each capture event concludes with storing the data as configured in REC_CTRL register in the user data buffers, which are accessible through the BUF_PNTR register (see Table 35).

The two different FFT modes that produce vibration data in spectral terms are MFFT and AFFT. The difference between these two modes is the manner in which data capture and analysis starts. In MFFT mode, users trigger a capture event by an external digital signal or through a software command using the GLOB_CMD register, Bit 11 (see Table 73). In AFFT mode, an internal timer automatically triggers additional spectral record captures without the need for an external trigger. Up to four different sample rate profiles can be selected for the modes to cycle through. The REC_PRD register (see Table 49) contains the user configuration settings for the time that elapses between each capture event when operating in the AFFT mode.

MTC Mode

When operating in MTC mode, the ADcmXL1021-1 captures 4096 consecutive time domain samples. An offset null signal can be calculated and applied to the data using the command register option. Signal processing functions such as low-pass and high-pass FIR filtering and averaging can be applied. After

digital processing is complete, the 4096 time domain sample data record of vibration data is stored into the user data buffers, using the signal flow diagram shown in Figure 28.

Capturing is triggered by either a SPI write to the GLOB_CMD register or by an external trigger. The ADcmXL1021-1 toggles the output BUSY when the data record is stored and the alarms are checked.

The decimation filter reduces the effective rate of stored data capture in the time record by averaging the sequential samples together and filtering out of band signal and noise. This filter has eight decimation rate settings (1, 2, 4, 8, 16, 32, 64, and 128) and can support up to four different settings. These time data records are time continuous captures with the decimation filter acting on real-time data from the ADC to produce 4096 samples (producing the 4096 time domain samples requires 2^N samples to be processed internally, where N is the average count value, AVG_CNT). When more than one user configured sample record setting is in use, the ADcmXL1021-1 applies a single filter for each data record and cycles through all desired options, one for each data capture. Time statistic alarms can be configured for three levels of reporting: normal, critical, and warning. A record mode option allows all enabled time domain statistics to be stored, depending on user preference, and is configured by setting the record mode in Register REC_CTRL, Bits[3:2] (Register 0x1A and Register 0x1B) = 0b10.

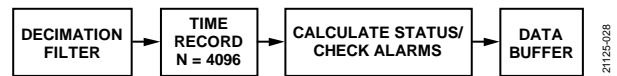

Figure 27. Signal Processing Diagram for Manual Time Capture (MTC) Mode

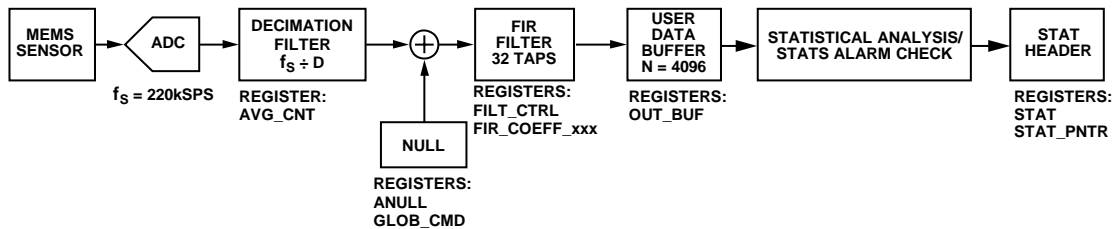

Figure 28. MTC Signal Flow Diagram

MFFT Mode

MFFT mode can manually trigger a capture to create a single FFT record with 2048 bins and allows various configuration options. The ADcmXL1021-1 has configurable high-pass and low-pass filters, decimation filtering, FFT averaging, and spectral alarms. The ADcmXL1021-1 also has options to calculate velocity, apply windowing, and apply offset compensation. MFFT mode is configured by setting the record mode in Register REC_CTRL, Bits[1:0] (Register 0x1A and Register 0x1B) = 0b00.

Processing steps collect 4096 consecutive time domain samples and filters the data similar to the MTC case. Additional windowing and FFT averaging can be enabled and configured using the 4096 sample burst captures. The ADcmXL1021-1 provides three different mathematical filtering options to process the time record data, prior to performing an FFT, the filter options are rectangular, Hanning, or flat top. See the REC_CTRL register in Table 47 for more information on selecting the window option.

When a capture event is triggered by the user, the event follows the process flow diagram shown in Figure 29. The FIR filter has 32 coefficients and processes at the full internal ADC sample rate of 220 kSPS. Users can select from one of six FIR filter bank options. Three of these filter banks have preset coefficients that provide low-pass responses to support half power bandwidths of 1 kHz, 5 kHz, and 10 kHz, respectively. The other three filter banks have preset coefficients that provide high-pass responses to support half power bandwidths of 1 kHz, 5 kHz, and 10 kHz filter. All six filter banks can be overwritten through user programming and stored to flash memory.

After the FIR filter is applied to the time domain data, if enabled, the data is decimated according to the AVG_CNT setting until a full 4096 time sample capture fills the data buffer. This decimation produces a time record that is converted to a spectral record and averaged, depending on the FFT_AVG1 or the FFT_AVG2 setting, as appropriate (see Figure 41 for the FFT capture datapath and appropriate registers).

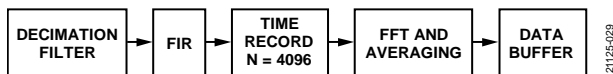

Figure 29. Signal Processing Diagram for FFT Modes

AFFT Mode

AFFT mode is configured by setting the record mode in Register REC_CTRL, Bits[1:0] (Register 0x1A and Register 0x1B) = 0b01. AFFT mode supports the same functionality as MFFT mode, except AFFT mode automatically advances and independently controls new capture events. New capture events are triggered periodically and are configured in the register map using REC_PRD.

To save power for long off time durations, the device can be configured to sleep between auto captures using Bit 7 in the REC_CTRL register.

RTS Mode

RTS mode is configured by setting the record mode in Register REC_CTRL, Bits[1:0] (Register 0x1A and Register 0x1B) = 0b11.

When operating in RTS mode, the ADcmXL1021-1 samples the accelerometer at a rate of 220 kSPS and makes this data available through a burst pattern via the SPI.

DATA RECORDING OPTIONS

The ADcmXL1021-1 creates data records in FFT and MTC modes and supports three methods of data storage for each data record: immediate only, alarm triggered, and all mode. In MTC mode, the time domain statistics are stored and are not the time records.

When immediate only mode is selected, only the most recent capture data record is retained and accessible.

In alarm triggered mode, only data that triggered an alarm is stored. When an alarm event is triggered, the ADcmXL1021-1 stores the header registers and the FFT data to flash memory. Alarm triggered mode is helpful for continuous operation while minimally impacting the limited endurance of the flash memory.

In all mode, each data record is stored. The data stored includes FFT header information and FFT data. Up to 10 FFT records can be stored and retrieved.

The ADcmXL1021-1 samples, processes, and stores vibration data to the FFT or the MTC data. In MTC mode, the record contains 4096 samples. In MFFT mode and AFFT mode, each record contains the 2048 bin FFT results. Table 6 describes the registers that provide access to processed sensor data.

Table 6. Output Data Registers

Register	Address	Description
TEMP_OUT	0x02	Internal temperature measurement
SUPPLY_OUT	0x04	Internal power supply measurement
BUF_PNTR	0x0A	Data buffer index pointer
REC_PNTR	0x0C	FFT record index pointer
OUT_BUF	0x12	Accelerometer data buffer
GLOB_CMD	0x3E	Global command register
TIME_STAMP_L	0x4C	Timestamp, lower word
TIME_STAMP_H	0x4E	Timestamp, upper word
REC_INFO1	0x66	FFT record header information
REC_INFO2	0x68	FFT record header information

Reading Data from the Data Buffer

After completing a spectral record and updating each data buffer, the ADcmXL1021-1 loads the first data sample from each data buffer to the OUT_BUF registers (see Table 11) and sets the buffer index pointer in the BUF_PNTR register to 0x0000 (see Table 7). The index pointer determines which data samples load to the OUT_BUF registers. For example, writing 0x009F to the BUF_PNTR register (DIN = 0x8A9F, DIN = 0x8B00) causes the 160th sample in each data buffer location to load to the OUT_BUF registers. The index pointer automatically increments with each OUT_BUF read command, which causes the next set of capture data to load to each capture buffer register. This automatic increment enables an efficient method for reading all 4096 time samples or 2048 FFT points in a record, using sequential read commands, without needing to manipulate the BUF_PNTR register.

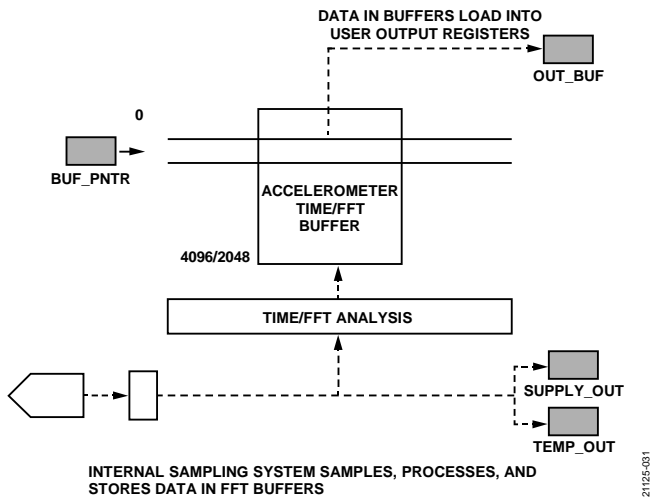

Figure 30. Data Buffer Structure and Operation

Table 7. BUF_PNTR (Base Address = 0x0A), Read/Write

Bits	Description (Default = 0x0000)
[15:12]	Not used
[11:0]	Data bits; range = 0 to 2047 (FFT), 0 to 4095 (time)

Accessing FFT Record Data

Up to 10 FFT records can be stored in flash memory. The REC_PNTR register (see Table 8) and GLOB_CMD bit (Bit 13, see Figure 31) provide access to the FFT records.

The process when FFT averaging is enabled is as follows:

1. A capture is initiated.
2. Time domain samples are captured and filtered according to AVG_CNT setting until 4096 time samples fill the buffer.
3. The FFT is calculated from the time samples in the buffer and the record is stored.
4. After the number of FFT averages is reached, all FFT records in memory are averaged and stored.
5. Alarms are checked, flags are set, and the data record is stored as per configuration
6. In either manual or automatic mode, the next sample rate option is set.
7. The BUSY signal is set.

An FFT record is an FFT stored in flash, and an FFT capture is an FFT stored in RAM.

Table 8. REC_PNTR (Base Address = 0x0C), Read/Write

Bits	Description (Default = 0x0000)
[12:8]	Time statistic record pointer address
[3:0]	FFT record number pointer address

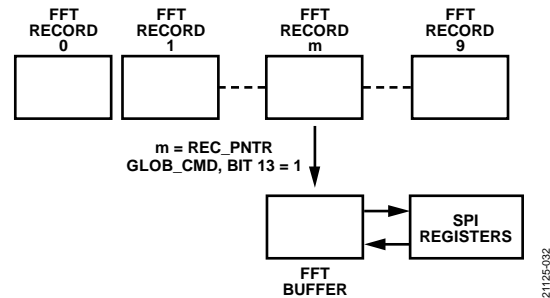

Figure 31. FFT Record Access

MTC Data Format

In MTC mode, the OUT_BUF register contains a single time domain sample. When reading OUT_BUF, BUF_PNTR automatically advances from 0 to 4095. The time domain data is 16-bit, twos complement acceleration data by default with a resolution of 1 LSB = 1.907 mg. If velocity data is selected by setting REC_CTRL, Bit 5 = 1, velocity data is stored in the buffer registers instead. Velocity data has a resolution of 1 LSB = 18.62 mm/sec and is calculated by integrating the acceleration data.

Table 11 lists the bit assignments for the OUT_BUF register. The acceleration data format depends on the record type setting in the REC_CTRL register. Table 41 and Table 42 shows data formatting examples for the 16-bit, twos complement format used in manual time mode.

In MTC mode, time domain statistic can be calculated by enabling Bit 6 in the REC_CTRL register. The statistics value scales are calculated based on setting of accelerometer or velocity. The time domain statistics available are mean, standard deviation, peak, peak-to-peak, crest factor, Kurtosis, and skewness. The scale of all statistics are consistent with the data format selected (1 LSB = 1.907 mg or 18.62 mm/sec for acceleration or velocity, respectively), except crest factor, Kurtosis, and skew, which require fractional numbers.

Table 9. MTC Mode, 50 g Range, Data Format Examples

Acceleration (mg) (1.907 mg/LSB)	LSB	Hex.	Binary
+62486.7	+32,767	0x7FFF	0111 1111 1111 1111
+12498.5	+6554	0x199A	0001 1001 10011010
+3.9	+2	0x0002	0000 0000 0000 0010
+1.9	+1	0x0001	0000 0000 0000 0001
0	0	0x0000	0000 0000 0000 0000
-1.9	-1	0xFFFF	1111 1111 1111 1111
-3.8	-2	0xFFFE	1111 1111 1111 1110
-12498.5	-6554	0xE666	1110 0110 0110 0110
-62488.6	-32,768	0x8000	1000 0000 0000 0000

Table 10. MTC Mode, 50 g Range, Data Format Examples, Configured for Optional Velocity Output Mode

Velocity (mm/sec), LSB = 18.62 mm/sec	LSB	Hex.	Binary
+610,121.5	+32,767	0x7FFF	0111 1111 1111 1111
+122,035.5	+6554	0x199A	0001 1001 10011010
+37.24	+2	0x0002	0000 0000 0000 0010
+18.62	+1	0x0001	0000 0000 0000 0001
0	0	0x0000	0000 0000 0000 0000
-18.62	-1	0xFFFF	1111 1111 1111 1111
-37.24	-2	0xFFFE	1111 1111 1111 1110
-122,035.5	-6554	0xE666	1110 0110 0110 0110
-610,121.5	-32,768	0x8000	1000 0000 0000 0000

Table 11. OUT_BUF (Base Address = 0x12), Read Only

Bits	Description (Default = 0x8000)
[15:0]	Output acceleration data buffer register. Format = twos complement (time), unsigned integer (FFT).

FFT Data Format for AFFT and MFFT Modes

In both AFFT and MFFT modes, the OUT_BUF contains a calculated FFT bin magnitude. The values contained in buffer locations from 0 to 2047 represent the magnitude of frequency bins of size, depending on the AVG_CNT value as shown in Table 18.

The magnitude (out) can be calculated from the value read by using the following equation:

$$Out = \left(\frac{2^{\left(\frac{OUT_BUF}{2048}\right)}}{\text{Number of FFT Averages}} \right) \times 0.9535 \text{ mg}$$

Table 12 and Table 43 show the data formatting examples for FFT mode conversions from the OUT_BUF value to acceleration.

When reading the OUT_BUF register, BUF_PNTR automatically advances from 0 to 2047. The FFT data is unsigned 16-bit data.

Table 12. FFT Magnitude Conversion from Register Value, Data Format Examples

FFT Buffer Read Value (Bits)	FFT Averages	Magnitude
0x0001	1	0.953823 mg
0x0002	1	0.954146 mg
0x00FF	1	1.039447 mg
0x7D00	1	48.18528 g
0x0001	2	0.476911 mg
0x0002	2	0.477073 mg
0x00FF	2	0.519724 mg
0x0005	4	0.238779 mg
0x05FF	4	0.400762 mg
0x7530	4	6.121809 g
0x00FF	8	0.129931 mg
0x7D00	8	6.02316 g
0x7D00	16	3.01158 g
0xAFCE	128	30.65768 g

RTS Data Format

In RTS mode, continuous data is burst out of the SPI. Each data frame consists of 16 samples of accelerometer data plus eight words of zeros and a frame header, temperature reading, status bits, and a 16-bit cyclical redundancy check (CRC) code. Each data sample is 16-bit, twos complement acceleration data by default with a resolution of 1 LSB = 1.907 mg. It is important that the external host device is able to retrieve the burst data in a sufficient time allotment, which is approximately 135 μs per data frame. No internal corrections are applied to this data. Therefore, the data may deviate from the results of other capture modes. Data is unsigned and must be offset (subtract) by 0x8000 to obtain ±g (signed data).

When first entering RTS mode capture, the first eight samples are all 0s and the CRC for the first frame is invalid. It is recommended that the first data frame be ignored, and data for the second frame and all subsequent frames be used.

Table 13 shows several examples of how to translate RTS data values, assuming nominal sensitivity and zero bias error.

Table 13. RTS Mode Data Format Examples

Acceleration (g)	LSB	Hex.	Binary
+62.532	65,535	0xFFFF	1111 1111 1111 1111
+50	58,967	0xE657	1110 0110 0101 0111
+0.003816	32,770	0x8002	1000 0000 0000 0010
+0.001908	32,769	0x8001	1000 0000 0000 0001
0	32,768	0x8000	1000 0000 0000 0000
-0.001908	32,767	0x7FFF	0111 1111 1111 1111
-0.003816	32,766	0x7FFE	0111 1111 1111 1110
-50	6567	0x19A7	0001 1001 1010 0111
-62.534	0	0x0000	0000 0000 0000 0000

USER INTERFACE

The user interface includes several important functions: a data communications port, a trigger input, a busy indicator, and two alarm indicator signals.

Data communication between an embedded processor (master) and the ADcmXL1021-1 takes place through the SPI, which includes the CS, SCLK, DIN, and DOUT pins (see Table 5).

The SYNC/RTS (see Table 5) pin provides user triggering options in manual triggering modes. The alarm pins, ALM1 and ALM2, are configurable to alert the user of an event that exceeds a user defined threshold of a parameter.

The SYNC/RTS pin is used in RTS mode to support start and stop control over data capture and analysis operations. The BUSY pin (see Table 5) provides an indication of internal operation when the ADcmXL1021-1 is executing a command. This signal helps the master processor avoid SPI communication when the ADcmXL1021-1 cannot support a response and can trigger an external data acquisition after data capture and analysis events are complete.

The ADcmXL1021-1 uses an SPI for communication, which enables simple connection with most embedded processor platforms, as shown in Figure 32.

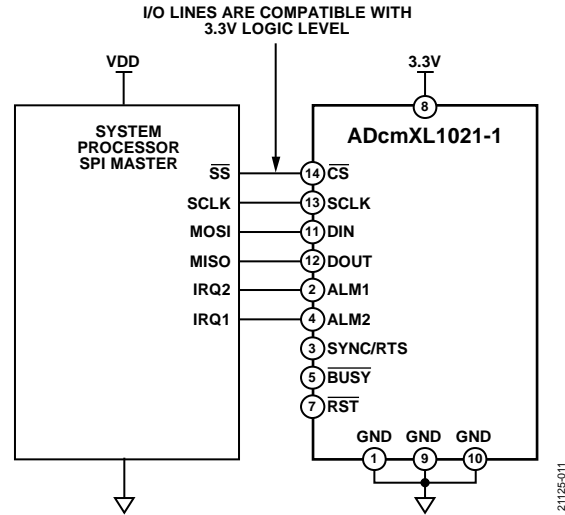

Figure 32. Electrical Hookup Diagram

The register structure uses a paged addressing scheme that contains seven pages, with each page containing 64 register locations. Each register is 16 bits wide, with each 2-byte word having its own unique address within the memory map of that page. The SPI port has access to one page at a time. Select the page to activate for SPI access by writing the corresponding code to the PAGE_ID register. Read the PAGE_ID register to determine which page is currently active. Table 14 displays the PAGE_ID contents for each page and the basic functions. The PAGE_ID register is located at Address 0x00 on each page.

Table 14. User Register Page Assignments

Page No.	PAGE_ID	Function
0	0x00	Configuration, data acquisition
1	0x01	FIR Filter Bank A
2	0x02	FIR Filter Bank B
3	0x03	FIR Filter Bank C
4	0x04	FIR Filter Bank D
5	0x05	FIR Filter Bank E
6	0x06	FIR Filter Bank F

The factory default configuration for the BUSY pin provides a busy indicator signal that transitions high when an event completes and data is available for user access and remains low during processing.

Table 15. Generic Master Processor Pin Mnemonics and Functions

Pin Mnemonic	Function
SS	Slave select
SCLK	Serial clock
MOSI	Master output, slave input
MISO	Master input, slave output
IRQ1, IRQ2	Interrupt request inputs (optional)

The ADcmXL1021-1 SPI supports full duplex serial communication (simultaneous transmit and receive) and uses the bit sequence shown in Figure 36. Table 16 shows a list of the most common settings that control the operation of SPI-compatible ports in most embedded processor platforms.

Embedded processors typically use control registers to configure serial ports for communicating with SPI slave devices, such as the ADcmXL1021-1. Table 16 lists settings that describe the SPI protocol of the ADcmXL1021-1. The initialization routine of the master processor typically establishes these settings using firmware commands to write them into the serial control registers.

Table 16. Generic Master Processor SPI Settings

Processor Setting	Description
Master	ADcmXL1021-1 operates as slave
SCLK Rate ≤ 14 MHz	Bit rate setting
SPI Mode 3	Clock polarity/phase (CPOL = 1, CPHA = 1)
MSB First	Bit sequence
16-Bit Mode	Shift register/data length
Readout Formatting	Little Endian

Table 19 lists user registers with lower byte addresses. Each register consists of two bytes. Each byte has a unique 7-bit address. Figure 33 relates the bits of each register to the upper and lower addresses.

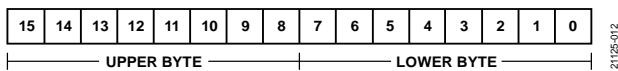

Figure 33. Generic Register Bit Definitions

Register Structure

All communication with the ADcmXL1021-1 involves accessing the user registers. The register structure contains both output data and control registers. The output data registers include the latest sensor data, alarm information, error flags, and identification data. The control register contained in Page 0 includes configurable options, such as time domain averaging, FFT averaging, filtering, alarm parameters, diagnostics, and data collection mode settings. Each user accessible register has two bytes (upper and lower), and each byte has a unique address. See Table 19 for a detailed list of all user registers, along with the corresponding addresses.

All communication between the ADcmXL1021-1 and an external processor involves either reading or writing these 16-bit user registers.

SPI Write Commands

User control registers govern many internal operations. The DIN bit sequence in Figure 36 provides a description to write to these registers. Each configuration register contains 16 bits (two bytes). Bits[7:0] contain the low byte, and Bits[15:8] contain the high byte of each register. Each byte has a unique address in the user register map (see Table 19). Updating the contents of a register requires writing both bytes in the following sequence: low byte first, high byte second. There are three parts to coding a SPI command (see Figure 36) that write a new byte of data to a register: the write bit (R/W = 1), the address of the byte [A6:A0], followed by the new data for that register address [DC7:DC0].

Figure 34 provides a coding example for writing 0x2345 to the FFT_AVG1 register, the 0x8623 command writes 0x23 to Address 0x06 (lower byte) and the 0x8745 command writes 0x45 to Address 0x07 (upper byte).

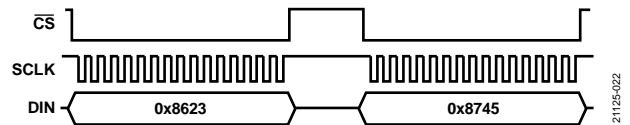

Figure 34. Single SPI Write Command

SPI Read Commands

A single register read requires two 16-bit SPI cycles that use the bit assignments shown in Figure 36. The beginning sequence sets R/W = 0 and communicates the target address (Bits[A6:A0]). Bits[DC7:DC0] are don't care bits for a read DIN sequence. DOUT clocks out the requested register contents during the second sequence. The second sequence can also use DIN to set up the next read.

Figure 35 provides an example that includes two register reads in succession. This example starts with DIN = 0x0C00 to request the contents of the REC_PNTR register, and follows with 0x0E00, to request the contents of the OUT_BUF register. The sequence in Figure 35 also shows the full duplex mode of operation, which means that the ADcmXL1021-1 can receive requests on DIN while also transmitting data out on DOUT within the same 16-bit SPI cycle.



Figure 35. SPI Multibyte Read Command Example

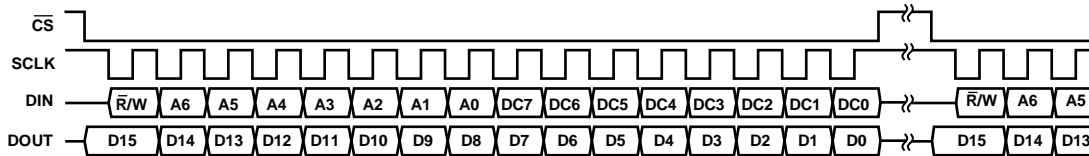

NOTES

1. DOUT BITS ARE PRODUCED ONLY WHEN THE PREVIOUS 16-BIT DIN SEQUENCE STARTS WITH R/W = 0.
2. WHEN CS IS HIGH, DOUT IS IN A THREE-STATE, HIGH IMPEDANCE MODE, WHICH ALLOWS MULTIFUNCTIONAL USE OF THE LINE FOR OTHER DEVICES.

Figure 36. SPI Communication, Multibyte Sequence

Busy Signal

The factory default configuration provides the user with a busy signal ($\overline{\text{BUSY}}$) that pulses low when the output data registers are updating (see signal orientation of busy signal in Figure 37). In this configuration, connect $\overline{\text{BUSY}}$ to an interrupt service pin on the embedded processor, which triggers data collection, when this signal pulses high.

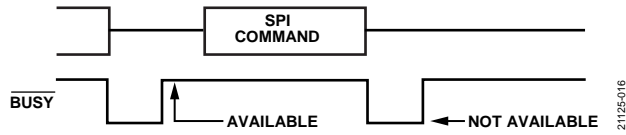

Figure 37. Busy Signal ($\overline{\text{BUSY}}$) Orientation After SPI Command

During the start-up and reset recovery processes, the $\overline{\text{BUSY}}$ signal can exhibit some transient behavior before data production begins. Figure 37 provides an example of the $\overline{\text{BUSY}}$ behavior during command processing. A low signal indicates SPI access is not available with the exception of the escape code that can terminate a capture. Figure 38 shows the $\overline{\text{BUSY}}$ signal during start up.

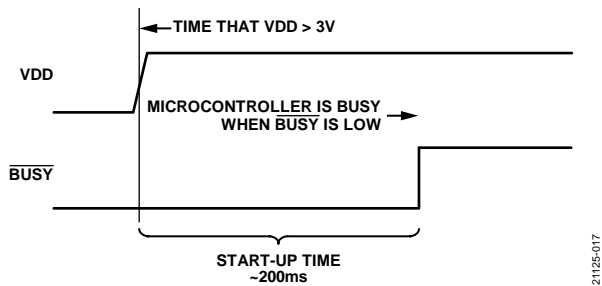

Figure 38. $\overline{\text{BUSY}}$ Response During Start Up

RTS

The RTS function provides a method for reading data (time domain acceleration data, temperature, status, and CRC code) that does not require a stall time between each 16-bit segment and only requires one command on the DIN line to initiate. System processors can execute this mode by reading each segment of data in the response, while holding the $\overline{\text{CS}}$ line in a low state until after reading the last 16-bit segment of data. If the $\overline{\text{CS}}$ line goes high before the completion of all data acquisition, the data from that read request is lost.

The RTS burst contains 44 16-bit words (8 zero words, a header, including an incrementing counter, 32 accelerometer data words, temperature, status, and CRC). The external SCLK rate must be between 8 MHz to 14 MHz to ensure that the complete burst is read out before current data in the register buffer is overwritten. The maximum SCLK for RTS burst outputs is 14 MHz \pm 1%. The minimum SCLK required to support the transfer is 8 MHz. The RTS burst response uses the sequencing diagrams shown in Figure 4 and Figure 5 and the data format shown in Table 17.

When first entering RTS mode capture, the first eight samples are all 0s, and the CRC for the first frame is invalid. It is recommended that the first frame be ignored, and that the data for the second frame and all subsequent frames be used.

Table 17. RTS Data Format

Byte Location in Output Dataset	2-Byte Value Represents
0	0x0000
...	...
14	0x0000
16	Fixed header: 0xccAD; where cc is an incrementing counter value from 0x00 to 0xFF, which returns to 0x00 after 0xFF
18	XL1 (oldest data from accelerometer)
20	XL2
22	XL3
...	...
80	XL32
82	Temperature
84	Status
86	CRC-16

BASIC OPERATION

DEVICE CONFIGURATION

Each register contains 16 bits (two bytes). Bits[7:0] contain the low byte, and Bits[15:8] contain the high byte. Each byte has a unique address in the user register map (see Table 19). Updating the contents of a register requires writing to the low byte first and the high byte second. There are three parts to coding a SPI command, which writes a new byte of data to a register: the write bit ($R/W = 1$), the 7-bit address code for the byte that this command is updating, and the 16 bits of new data for that location.

DUAL MEMORY STRUCTURE

The ADcmXL1021-1 uses a dual memory structure (see Figure 39) with static random access memory (SRAM), supporting real-time operation and flash memory storing operational code and user configurable register settings. The manual flash update command (Bit 6 in the GLOB_CMD register) provides a single command method for storing user configuration settings to flash memory for automatic recall during the next power-on or reset recovery process. During power-on or reset recovery, the ADcmXL1021-1 performs a CRC on the SRAM and compares this result to a CRC computation from the same memory locations in flash memory. If this memory test fails, the ADcmXL1021-1 resets and boots up from the other flash memory location. The ADcmXL1021-1 provides an error flag for detecting when the backup flash memory supported the last power-on or reset recovery. Table 19 shows a memory map for the user registers in the ADcmXL1021-1, which includes flash backup support (indicated by yes or no in the flash column).

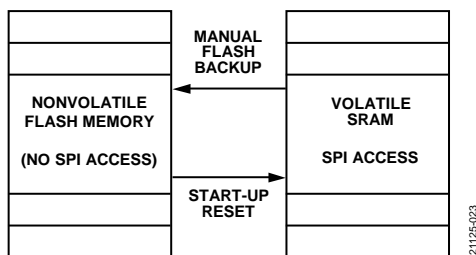

Figure 39. SRAM and Flash Memory Diagram

POWER-UP SEQUENCE

The ADcmXL1021-1 requires only a single 3.3 V supply voltage and supports communication with most 3 V compliant embedded processor platforms using an SPI protocol. Avoid applying voltage to the SYNC/RTS, \overline{CS} , SCLK, and DIN input pins until the proper supply voltage is applied to the module.

The power ramp from 0 V to 3.0 V must be monotonic. The module performs internal initialization, tests flash memory, and performs a sensor self test after powering on. No SPI access is allowed during this time. The module signals a completed initialization by setting the \overline{BUSY} pin logic high.

TRIGGER

All modes, including RTS mode, require a trigger to start. AFFT mode and RTS mode also require a trigger to stop recording.

Start triggers arise either from using the SYNC/RTS digital input pin or by setting Bit 11 in the GLOB_CMD register (see Table 73). If using the SYNC/RTS pin as a trigger, the user must set Bit 12 in the MISC_CTRL register = 1 to enable this feature. While in RTS mode, during a valid capture period, normal SPI access is disabled until a valid stop is received.

The user can stop a capture in RTS mode in two ways: via a hardware pin or using software. The hardware pin method uses the RTS pin, which is enabled in Bit 12 of the MISC_CTRL register. The software method requires the user to set Bit 15 in the REC_CTRL register to 1, which enables timeout mode which must be configured prior to initiating a capture. In this case, RTS mode stops after 30 ms with no user supplied external readback clocks with \overline{CS} low. To restart RTS mode, use the normal start trigger options described in this section.

To stop a capture in AFFT mode, the user must issue a stop command during a period when \overline{BUSY} is high (\overline{BUSY} is low when the device is configured for power saving mode and sleeps between captures) or by write an escape code to the device at any time. All other SPI writes are ignored. When the ADcmXL1021-1 is in between active collecting periods (as configured in the REC_PRD register), setting Bit 11 in the GLOB_CMD register (see Table 73) to 1 ($DIN = 0xBF08$) interrupts the operation and the ADcmXL1021-1 returns to operating in the idle state. The REC_PRD counter starts at the beginning of the capture and must be set to a period greater than the longest capture time if multiple rate options (Sample Rate 0 to Sample Rate 3) are enabled.

When operating in MFFT or MTC mode, the ADcmXL1021-1 operates in an idle state until it receives a command to start collecting data. When the ADcmXL1021-1 is in this idle state, setting Bit 11 in the GLOB_CMD register (see Table 73) to 1 starts a data collection and processing event. An interruption of data collection and processing causes a loss of all data from the interrupted process. A positive pulse on the SYNC/RTS pin provides the same start function as raising Bit 11 in the GLOB_CMD register when operating in MFFT mode.

In cases with many averages, a capture event can last an extended period with access to the SPI port (for example, when a device stays in a busy state). In this case, an escape code is used to terminate the active capture. The escape code is 0x00E8 and is written to the GLOB_CMD register, using the two 16-bit sequence 0xBEE8, followed by 0xBF00 and repeat until \overline{BUSY} returns to a high logic state. A valid escape is also indicated in Bit 4 of the DIAG_STAT register. After an escape is issued, any data collected during the last capture is no longer valid. To continue capturing data, refer to the normal start trigger options.

SAMPLE RATE

RTS mode has a fixed sample rate of 220 kSPS. The output is streamed out in a burst data packet over the SPI communications port. After the device is configured for RTS mode, conversion starts and stops are controlled by the SYNC/RTS pin or by stopping SPI activity for a period of time (see Bit 15 of the REC_CTRL register). RTS mode is unique in that, when configured, no additional processing is performed and samples are output directly from the ADC without null, filter, or digital signal processing and alarms are not checked. A low-pass analog filter with a 13.5 kHz cutoff frequency is always in the datapath and, along with the high ADC sample rate, prevents aliasing.

For MTC mode, the sampling rate is always 220 kSPS and captures 4096 samples. The module can be configured to perform internal digital averaging.

For the null function (see Figure 28), the user can write offset correction values into the ANULL register (see Table 45). The user can also initiate the autonull command via Bit 0 in the GLOB_CMD register (see Table 73), which automatically estimates the offset error and writes correction values to the ANULL register. The autonull feature uses settings of SR3 to capture and calculate a correction value and requires time to complete.

The AVG_CNT register allows the selection of the number of averages used in each capture for up to four sample rate options. The REC_CTRL register selects which sample rate options are enabled. The number of averages determines the sample rate for each sample rate option by the following equation:

$$\text{Sample Rate} = 220 \text{ kHz} / 2^{\text{AVG_CNT}[3:0]}$$

Table 18. FFT Bin Sizes, Frequency Limits (Hz)

AVG_CNT Setting (Averages)	Effective Sample Rate, f_s (SPS)	Effective FFT Bin Size, f_{MIN} (Hz)	Effective Maximum FFT Frequency, f_{MAX} (Hz)
0 (1)	220000	53.71094	110000
1 (2)	110000	26.85547	55000
2 (4)	55000	13.42773	27500
3 (8)	27500	6.713867	13750
4 (16)	13750	3.356934	6875
5 (32)	6875	1.678467	3437.5
6 (64)	3437.5	0.839233	1718.75
7 (128)	1718.75	0.419617	859.375

In MFFT mode and AFFT mode, each FFT data record starts with a capture of 4096 time domain samples (after decimation, if enabled), as with MTC mode. The data is processed with the null function and FIR filter after the decimation filter, as with MTC mode. An FFT calculation is performed on the data. This

data is stored in user accessible buffer, in place of the time domain values, and spectral alarms are checked.

An important note is that the execution of the retrieve record with many FFT averages and a low sample rate may take minutes to hours to complete. Because the device turns off SPI interrupts during a recording, the user cannot send a stop command. Instead, the device monitors the SPI receive buffer for the escape code, a SPI write of 0x00E8 to the GLOB_CMD register, during the data capture portion of the recording. Therefore, the user can escape from a recording by writing 0x00E8 to the GLOB_CMD register. It is recommended to write only 0x00E8 to the device, provide a small delay, and then monitor the busy indicator or poll the status register. Repeatedly send the 0x00E8 code and check the status register until the status register shows the escape flag and busy indicator/data ready flag.

DATAPATH PROCESSING

For RTS mode, there is no digital processing of data internal to the ADcmXL1021-1. Data is buffered internally to 32 sample packets that are burst output over the SPI interface.

For MTC mode, AFFT mode, and MFFT mode, the initial capture and processing procedure is the same and is as follows:

1. Capture 4096 consecutive time domain samples at 220 kSPS.
2. If AVG_CNT is enabled, apply the appropriate decimation filter. Continue to collect data until 4096 time sample buffer is filled.
3. Null data, if enabled.
4. Apply the FIR filter, if enabled.

If MTC mode is enabled, the remaining steps are required:

5. Calculate the statistic values enabled.
6. Check the statistics against alarm settings.
7. Write the statistic values to the data buffer.
8. Calculate time domain statistics.
9. Check time domain alarms and set the alarm bit if appropriate.
10. Record statistic data according to the storage option selected.
11. Perform signal completion by setting the $\overline{\text{BUSY}}$ pin.

If AFFT or MFFT mode is enabled, the remaining steps occur after the initial capture and processing:

5. Calculate the FFT based on the AVG_CNT setting.
6. Record data according to the storage option selected.
7. Check frequency domain alarms, set the alarm bit if appropriate.
8. Signal completion by setting the $\overline{\text{BUSY}}$ pin.

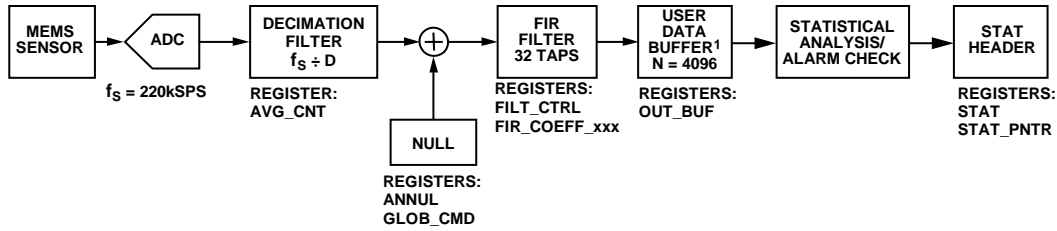

1 OPTIONAL VELOCITY CALCULATIONS APPLIED PRIOR TO USER BUFFER.

Figure 40. MTC Mode Datapath Processing

21125-027

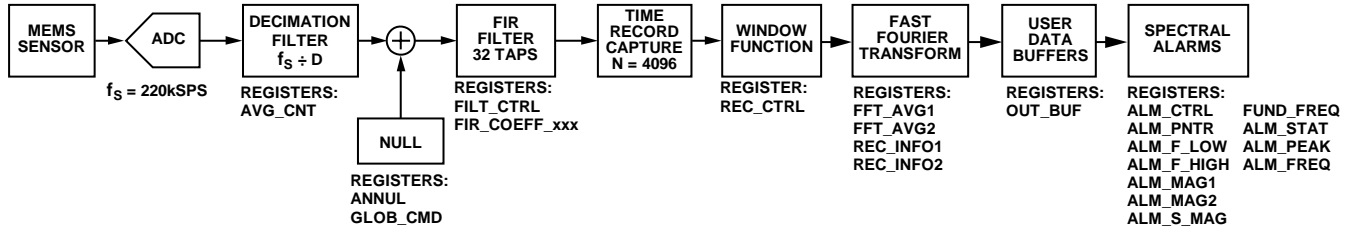

Figure 41. AFFT Mode and MFFT Mode Datapath Processing

21125-028

After null corrections are applied, the data of the inertial sensor passes through an FIR filter (using the FILT_CTRL register), decimation filter (using the AVG_CNT register), and windowing filter (using the REC_CTRL register), all of which have user configurable attributes.

The FIR filter includes six banks of coefficients with 32 taps each. The FILT_CTRL register (see Table 65) provides the configuration options for the use of the FIR filters of each inertial sensor. Each FIR filter bank includes a preconfigured filter, but the user can design filters and write over these values using the register of each coefficient. Default filter configuration options are either low-pass or high-pass filters with cutoff frequencies of either 1 kHz, 5 kHz, or 10 kHz. Page 1 through Page 6 define the six sets of FIR filter coefficients. Each page is dedicated to a single filter. For example, Page 1 in the register map provides the details for the 1 kHz low-pass FIR filter. These filters represent typical cutoff frequencies for machine vibration monitoring applications.

FIR Filter

Six FIR filters are preprogrammed by default in memory and available for use. The coefficients for these filters are stored in Page 1 to Page 6 and provide selectable filter options for the 1 kHz, 5 kHz, or 10 kHz low-pass filter, and the 1 kHz, 5 kHz, or 10 kHz high-pass filter. Users can write and store custom filter setting by overwriting existing filter coefficients and saving these values to flash memory.

Decimation

Averaging options are available within the ADcmXL1021-1 and reduce the amount of data required to be transferred for a given bandwidth while also reducing random noise impact on the signal to noise ratio. Decimation is set using the AVG_CNT register and enabled in REC_CTRL register. The decimation filter can be used when the module is configured for MTC, MFFT, or AFFT operation but is not available in RTS mode. Table 69 shows selectable sample rates and resulting FFT bin width options.

MTC mode, AFFT mode, and MFFT mode can be configured to cycle automatically through up to four different AVG_CNT settings (enabled in the REC_CTRL register): SR0, SR1, SR2, and SR3.

When more than one sample rate option is enabled (REC_CTRL register, Bit 8 through Bit 11, see Table 47), the device cycles through each one.

Windowing

There are three windowing options that can be applied to the time domain recording before the FFT is computed. The typical window for vibration monitoring is the Hanning window. This window is provided as a default. A Hanning window is optimal because it offers good amplitude resolution of the peaks between frequency bins and minimal broadening of the peak. The rectangular and flat top windows are also available because they are common windowing options for vibration monitoring. The rectangular window is a window of magnitude 1 providing a flat time domain response. The flat top window is advantageous because it can provide very accurate amplitudes with the disadvantage of significant broadening of the peaks. This window is useful when the magnitude accuracy of the peak is important.

SPECTRAL ALARMS

When using MFFT mode or AFFT mode, six flexible alarms can be configured with settings. There are 48 possible alarm configurations considering there are six alarm bands ($\times 4$ sample rate options $\times 2$ magnitude alarm levels).

The ALM_PNTR register cycles through up to six alarm band configurations per capture. A lower frequency register (ALM_F_LOW) and an upper frequency register (ALM_F_HIGH) are set to define a bandwidth of interest. ALM_MAG1 and ALM_MAG2 define two levels of magnitude within the band set on which to base two triggers. These levels allow two warning levels for a trigger. Setting ALM_CTRL allows the setting of enabling and disabling individual axes, two warning levels, the number of events required to trigger an alarm, and the clearing options for the trigger alerts.

The alarm status is reported in the ALM_STAT register. These registers show which alarm caused the last alarm event. If the alarm is serviced immediately, REC_INFO1 and REC_INFO2 contain the last capture settings for additional information about the event. Based on the record mode (REC_CTRL, Bits[3:2]) setting, up to 10 FFT capture records can be stored in memory.

When an alarm is triggered, the values in the ALM_PEAK register represent the peak value. Only the values that triggered the alarm are stored when the measured value for the given conditions exceed the ALM_MAG1 and ALM_MAG2 threshold settings. The magnitude is in the resolution as configured by the FFT_AVG1 or FFT_AVG2 setting for the specific capture.

The alarm frequency bin of the peak deviation point is reported in ALM_FREQ. The result is in units of resolution (Hz), configured through the AVG_CNT setting for the specific capture.

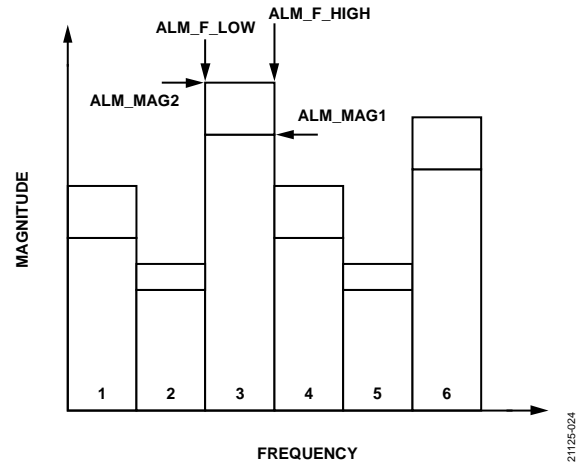

Figure 42. Spectral Alarm Band Registers

MECHANICAL MOUNTING RECOMMENDATIONS

Mechanical mounting is critical to ensure the best transfer of vibration and avoiding resonances that may affect performance. The ADcmXL1021-1 module has four mounting holes integrated in the aluminum housing.

The mounting holes accept M2.5 screws to hold the module in place. Stainless steel screws torqued to about 25 inch-pounds are used for many of the characterization curves shown in the Typical Performance Characteristics section.

In some cases, when permanent mounting is an option, industrial epoxies or adhesives, such as cyanoacrylate adhesive, in addition to the mounting screws can enhance mechanical coupling.

USER REGISTER MEMORY MAP

Table 19. User Register Memory Map¹

Register Name	R/W	Flash Backup	PAGE_ID	Address	Default	Register Description
PAGE_ID ²	R/W	No	0x00	0x00, 0x01	0x0000	Page identifier
TEMP_OUT	R	No	0x00	0x02, 0x03	0x8000 ³	Internal temperature
SUPPLY_OUT	R	No	0x00	0x04, 0x05	0x8000 ³	Power supply voltage (VDD)
FFT_AVG1	R/W	Yes	0x00	0x06, 0x07	0x0108	FFT average settings (SR0 and SR1)
FFT_AVG2	R/W	Yes	0x00	0x08, 0x09	0x0101	FFT average settings (SR2 and SR3)
BUF_PNTR	R/W	No	0x00	0x0A, 0x0B	0x0000	Buffer address pointer
REC_PNTR	R/W	No	0x00	0x0C, 0x0D	0x0000	Data record pointer
OUT_BUF	R	No	0x00	0x12, 0x13	0x8000	Output buffer data
ANULL	R/W	Yes	0x00	0x18, 0x19	0x0000	Bias correction value (from auto null)
REC_CTRL	R/W	Yes	0x00	0x1A, 0x1B	0x1102	Record control register (mode of operation)
Reserved	N/A	N/A	0x00	0x1C, 0x1D	0x00FF	Reserved
REC_PRD	R/W	Yes	0x00	0x1E, 0x1F	0x0000	Record period setting
ALM_F_LOW	R/W	Yes ⁴	0x00	0x20, 0x21	0x0000	Spectral alarm band, low frequency setting
ALM_F_HIGH	R/W	Yes ⁴	0x00	0x22, 0x23	0x0000	Spectral alarm band, high frequency setting
ALM_MAG1	R/W	Yes ⁴	0x00	0x28, 0x29	0x0000	Spectral alarm band, Alarm Magnitude 1
ALM_MAG2	R/W	Yes ⁴	0x00	0x2E, 0x2F	0x0000	Spectral alarm band, Alarm Magnitude 2
ALM_PNTR	R/W	No	0x00	0x30, 0x31	0x0000	Spectral alarm pointer
ALM_S_MAG	R/W	No	0x00	0x32, 0x33	0x0000	System alarm threshold setting
ALM_CTRL	R/W	Yes	0x00	0x34, 0x35	0x0080	Alarm control settings
Reserved	N/A	N/A	0x00	0x36, 0x37	0x0000	Reserved
FILT_CTRL	R/W	Yes	0x00	0x38, 0x39	0x0000	Filter control settings
AVG_CNT	R/W	Yes	0x00	0x3A, 0x3B	0x0000	Sample rate settings (SR0, SR1, SR2, and SR3)
DIAG_STAT	R	No	0x00	0x3C, 0x3D	0x0000	Diagnostic and status flags
GLOB_CMD	W	No	0x00	0x3E, 0x3F	0x0000	Global command triggers
ALM_STAT	R	Yes ⁵	0x00	0x44, 0x45	0x0000	Alarm status
ALM_PEAK	R	Yes ⁵	0x00	0x4A, 0x4B	0x0000	Alarm peak value
TIME_STAMP_L	R	Yes ⁵	0x00	0x4C, 0x4D	0x0000	Time stamp, lower word
TIME_STAMP_H	R	Yes ⁵	0x00	0x4E, 0x4F	0x0000	Time stamp, upper word
Reserved	N/A	N/A	0x00	0x50, 0x51	N/A	Reserved
DAY_REV	R	N/A	0x00	0x52, 0x53	N/A	Firmware revision and firmware day code
YEAR_MON	R	N/A	0x00	0x54, 0x55	N/A	Firmware date (month, year)
PROD_ID	R	N/A	0x00	0x56, 0x57	0x03FD	Product identification for ADcmXL1021-1 models, equals decimal 1021
SERIAL_NUM	R	N/A	0x00	0x58, 0x59	N/A	Serial number, lot-specific, unique per device
USER_SCRATCH	R/W	Yes	0x00	0x5A, 0x5B	N/A	Scratch register for user ID option
REC_FLASH_CNT	R	N/A	0x00	0x5C, 0x5D	N/A	Write counter for data record portion of flash memory
Reserved	N/A	N/A	0x00	0x5E to 0x63	N/A	Reserved
MISC_CTRL	R/W	No	0x00	0x64, 0x65	N/A	Miscellaneous control
REC_INFO1	R	Yes ⁵	0x00	0x66, 0x67	0x0000	Record Information 1
REC_INFO2	R	Yes ⁵	0x00	0x68, 0x69	0x0000	Record Information 2
REC_CNTR	R	N/A	0x00	0x6A, 0x6B	0x0000	Record counter
ALM_FREQ	R	Yes ⁵	0x00	0x70, 0x71	0x0000	Frequency bin of most severe alarm
STAT_PNTR	R/W	No	0x00	0x72, 0x73	0x0000	Pointer for time domain statistics
Statistic	R	Yes ⁵	0x00	0x78, 0x79	0x0000	Selected statistical value
FUND_FREQ	R/W	Yes	0x00	0x7A, 0x7B	0x0000	Fundamental frequency setting
FLASH_CNT_L	R	N/A	0x00	0x7C, 0x7D	N/A	Flash access counter, lower 16 bits
FLASH_CNT_U	R	N/A	0x00	0x7E, 0x7F	0x0000	Flash access counter, upper 16 bits
PAGE_ID	R/W	No	0x01	0x00, 0x01	0x0001	Page identifier
FIR_COEF_A00	R/W	Yes	0x01	0x02, 0x03	0x0006	FIR Filter Bank A, Coefficient 0
FIR_COEF_A01	R/W	Yes	0x01	0x04, 0x05	0x0015	FIR Filter Bank A, Coefficient 1

Register Name	R/W	Flash Backup	PAGE_ID	Address	Default	Register Description
FIR_COEF_A02	R/W	Yes	0x01	0x06, 0x07	0x0035	FIR Filter Bank A, Coefficient 2
FIR_COEF_A03	R/W	Yes	0x01	0x08, 0x09	0x006B	FIR Filter Bank A, Coefficient 3
FIR_COEF_A04	R/W	Yes	0x01	0x0A, 0x0B	0x00C1	FIR Filter Bank A, Coefficient 4
FIR_COEF_A05	R/W	Yes	0x01	0x0C, 0x0D	0x013C	FIR Filter Bank A, Coefficient 5
FIR_COEF_A06	R/W	Yes	0x01	0x0E, 0x0F	0x01E0	FIR Filter Bank A, Coefficient 6
FIR_COEF_A07	R/W	Yes	0x01	0x10, 0x11	0x02AE	FIR Filter Bank A, Coefficient 7
FIR_COEF_A08	R/W	Yes	0x01	0x12, 0x13	0x03A2	FIR Filter Bank A, Coefficient 8
FIR_COEF_A09	R/W	Yes	0x01	0x14, 0x15	0x04B3	FIR Filter Bank A, Coefficient 9
FIR_COEF_A10	R/W	Yes	0x01	0x16, 0x17	0x05D2	FIR Filter Bank A, Coefficient 10
FIR_COEF_A11	R/W	Yes	0x01	0x18, 0x19	0x06EE	FIR Filter Bank A, Coefficient 11
FIR_COEF_A12	R/W	Yes	0x01	0x1A, 0x1B	0x07F2	FIR Filter Bank A, Coefficient 12
FIR_COEF_A13	R/W	Yes	0x01	0x1C, 0x1D	0x08CB	FIR Filter Bank A, Coefficient 13
FIR_COEF_A14	R/W	Yes	0x01	0x1E, 0x1F	0x0967	FIR Filter Bank A, Coefficient 14
FIR_COEF_A15	R/W	Yes	0x01	0x20, 0x21	0x09B9	FIR Filter Bank A, Coefficient 15
FIR_COEF_A16	R/W	Yes	0x01	0x22, 0x23	0x09B9	FIR Filter Bank A, Coefficient 16
FIR_COEF_A17	R/W	Yes	0x01	0x24, 0x25	0x0967	FIR Filter Bank A, Coefficient 17
FIR_COEF_A18	R/W	Yes	0x01	0x26, 0x27	0x08CB	FIR Filter Bank A, Coefficient 18
FIR_COEF_A19	R/W	Yes	0x01	0x28, 0x29	0x07F2	FIR Filter Bank A, Coefficient 19
FIR_COEF_A20	R/W	Yes	0x01	0x2A, 0x2B	0x06EE	FIR Filter Bank A, Coefficient 20
FIR_COEF_A21	R/W	Yes	0x01	0x2C, 0x2D	0x05D2	FIR Filter Bank A, Coefficient 21
FIR_COEF_A22	R/W	Yes	0x01	0x2E, 0x2F	0x04B3	FIR Filter Bank A, Coefficient 22
FIR_COEF_A23	R/W	Yes	0x01	0x30, 0x31	0x03A2	FIR Filter Bank A, Coefficient 23
FIR_COEF_A24	R/W	Yes	0x01	0x32, 0x33	0x02AE	FIR Filter Bank A, Coefficient 24
FIR_COEF_A25	R/W	Yes	0x01	0x34, 0x35	0x01E0	FIR Filter Bank A, Coefficient 25
FIR_COEF_A26	R/W	Yes	0x01	0x36, 0x37	0x013C	FIR Filter Bank A, Coefficient 26
FIR_COEF_A27	R/W	Yes	0x01	0x38, 0x39	0x00C1	FIR Filter Bank A, Coefficient 27
FIR_COEF_A28	R/W	Yes	0x01	0x3A, 0x3B	0x006B	FIR Filter Bank A, Coefficient 28
FIR_COEF_A29	R/W	Yes	0x01	0x3C, 0x3D	0x0035	FIR Filter Bank A, Coefficient 29
FIR_COEF_A30	R/W	Yes	0x01	0x3E, 0x3F	0x0015	FIR Filter Bank A, Coefficient 30
FIR_COEF_A31	R/W	Yes	0x01	0x40, 0x41	0x0006	FIR Filter Bank A, Coefficient 31
Reserved	N/A	N/A	0x01	0x42 to 0x7F	N/A	Reserved
PAGE_ID	R/W	No	0x02	0x00, 0x01	0x0002	Page identifier
FIR_COEF_B00	R/W	Yes	0x02	0x02, 0x03	0x0004	FIR Filter Bank B, Coefficient 0
FIR_COEF_B01	R/W	Yes	0x02	0x04, 0x05	0x0001	FIR Filter Bank B, Coefficient 1
FIR_COEF_B02	R/W	Yes	0x02	0x06, 0x07	0xFFEC	FIR Filter Bank B, Coefficient 2
FIR_COEF_B03	R/W	Yes	0x02	0x08, 0x09	0xFFB9	FIR Filter Bank B, Coefficient 3
FIR_COEF_B04	R/W	Yes	0x02	0x0A, 0x0B	0xFF62	FIR Filter Bank B, Coefficient 4
FIR_COEF_B05	R/W	Yes	0x02	0x0C, 0x0D	0xFE11	FIR Filter Bank B, Coefficient 5
FIR_COEF_B06	R/W	Yes	0x02	0x0E, 0x0F	0xFE8C	FIR Filter Bank B, Coefficient 6
FIR_COEF_B07	R/W	Yes	0x02	0x10, 0x11	0xFE76	FIR Filter Bank B, Coefficient 7
FIR_COEF_B08	R/W	Yes	0x02	0x12, 0x13	0xFEFE	FIR Filter Bank B, Coefficient 8
FIR_COEF_B09	R/W	Yes	0x02	0x14, 0x15	0x006B	FIR Filter Bank B, Coefficient 9
FIR_COEF_B10	R/W	Yes	0x02	0x16, 0x17	0x02E1	FIR Filter Bank B, Coefficient 10
FIR_COEF_B11	R/W	Yes	0x02	0x18, 0x19	0x0645	FIR Filter Bank B, Coefficient 11
FIR_COEF_B12	R/W	Yes	0x02	0x1A, 0x1B	0x0A34	FIR Filter Bank B, Coefficient 12
FIR_COEF_B13	R/W	Yes	0x02	0x1C, 0x1D	0x0E13	FIR Filter Bank B, Coefficient 13
FIR_COEF_B14	R/W	Yes	0x02	0x1E, 0x1F	0x1130	FIR Filter Bank B, Coefficient 14
FIR_COEF_B15	R/W	Yes	0x02	0x20, 0x21	0x12EC	FIR Filter Bank B, Coefficient 15
FIR_COEF_B16	R/W	Yes	0x02	0x22, 0x23	0x12EC	FIR Filter Bank B, Coefficient 16
FIR_COEF_B17	R/W	Yes	0x02	0x24, 0x25	0x1130	FIR Filter Bank B, Coefficient 17
FIR_COEF_B18	R/W	Yes	0x02	0x26, 0x27	0x0E13	FIR Filter Bank B, Coefficient 18
FIR_COEF_B19	R/W	Yes	0x02	0x28, 0x29	0x0A34	FIR Filter Bank B, Coefficient 19
FIR_COEF_B20	R/W	Yes	0x02	0x2A, 0x2B	0x0645	FIR Filter Bank B, Coefficient 20

Register Name	R/W	Flash Backup	PAGE_ID	Address	Default	Register Description
FIR_COEF_B21	R/W	Yes	0x02	0x2C, 0x2D	0x02E1	FIR Filter Bank B, Coefficient 21
FIR_COEF_B22	R/W	Yes	0x02	0x2E, 0x2F	0x006B	FIR Filter Bank B, Coefficient 22
FIR_COEF_B23	R/W	Yes	0x02	0x30, 0x31	0XFEFE	FIR Filter Bank B, Coefficient 23
FIR_COEF_B24	R/W	Yes	0x02	0x32, 0x33	0xFE76	FIR Filter Bank B, Coefficient 24
FIR_COEF_B25	R/W	Yes	0x02	0x34, 0x35	0XFE8C	FIR Filter Bank B, Coefficient 25
FIR_COEF_B26	R/W	Yes	0x02	0x36, 0x37	0XFEF1	FIR Filter Bank B, Coefficient 26
FIR_COEF_B27	R/W	Yes	0x02	0x38, 0x39	0xFF62	FIR Filter Bank B, Coefficient 27
FIR_COEF_B28	R/W	Yes	0x02	0x3A, 0x3B	0xFFB9	FIR Filter Bank B, Coefficient 28
FIR_COEF_B29	R/W	Yes	0x02	0x3C, 0x3D	0xFFEC	FIR Filter Bank B, Coefficient 29
FIR_COEF_B30	R/W	Yes	0x02	0x3E, 0x3F	0x0001	FIR Filter Bank B, Coefficient 30
FIR_COEF_B31	R/W	Yes	0x02	0x40, 0x41	0x0004	FIR Filter Bank B, Coefficient 31
Reserved	N/A	N/A	0x02	0x42 to 0x7F	N/A	Reserved
PAGE_ID	R/W	No	0x03	0x00, 0x01	0x0003	Page identifier
FIR_COEF_C00	R/W	Yes	0x03	0x02, 0x03	0x0025	FIR Filter Bank C, Coefficient 0
FIR_COEF_C01	R/W	Yes	0x03	0x04, 0x05	0x005A	FIR Filter Bank C, Coefficient 1
FIR_COEF_C02	R/W	Yes	0x03	0x06, 0x07	0x008F	FIR Filter Bank C, Coefficient 2
FIR_COEF_C03	R/W	Yes	0x03	0x08, 0x09	0x009A	FIR Filter Bank C, Coefficient 3
FIR_COEF_C04	R/W	Yes	0x03	0x0A, 0x0B	0x004D	FIR Filter Bank C, Coefficient 4
FIR_COEF_C05	R/W	Yes	0x03	0x0C, 0x0D	0xFF8D	FIR Filter Bank C, Coefficient 5
FIR_COEF_C06	R/W	Yes	0x03	0x0E, 0x0F	0xFE74	FIR Filter Bank C, Coefficient 6
FIR_COEF_C07	R/W	Yes	0x03	0x10, 0x11	0xFD5D	FIR Filter Bank C, Coefficient 7
FIR_COEF_C08	R/W	Yes	0x03	0x12, 0x13	0xFCDD	FIR Filter Bank C, Coefficient 8
FIR_COEF_C09	R/W	Yes	0x03	0x14, 0x15	0xFD97	FIR Filter Bank C, Coefficient 9
FIR_COEF_C10	R/W	Yes	0x03	0x16, 0x17	0x0003	FIR Filter Bank C, Coefficient 10
FIR_COEF_C11	R/W	Yes	0x03	0x18, 0x19	0x0430	FIR Filter Bank C, Coefficient 11
FIR_COEF_C12	R/W	Yes	0x03	0x1A, 0x1B	0x09A2	FIR Filter Bank C, Coefficient 12
FIR_COEF_C13	R/W	Yes	0x03	0x1C, 0x1D	0x0F5F	FIR Filter Bank C, Coefficient 13
FIR_COEF_C14	R/W	Yes	0x03	0x1E, 0x1F	0x142C	FIR Filter Bank C, Coefficient 14
FIR_COEF_C15	R/W	Yes	0x03	0x20, 0x21	0x16E8	FIR Filter Bank C, Coefficient 15
FIR_COEF_C16	R/W	Yes	0x03	0x22, 0x23	0x16E8	FIR Filter Bank C, Coefficient 16
FIR_COEF_C17	R/W	Yes	0x03	0x24, 0x25	0x142C	FIR Filter Bank C, Coefficient 17
FIR_COEF_C18	R/W	Yes	0x03	0x26, 0x27	0x0F5F	FIR Filter Bank C, Coefficient 18
FIR_COEF_C19	R/W	Yes	0x03	0x28, 0x29	0x09A2	FIR Filter Bank C, Coefficient 19
FIR_COEF_C20	R/W	Yes	0x03	0x2A, 0x2B	0x0430	FIR Filter Bank C, Coefficient 20
FIR_COEF_C21	R/W	Yes	0x03	0x2C, 0x2D	0x0003	FIR Filter Bank C, Coefficient 21
FIR_COEF_C22	R/W	Yes	0x03	0x2E, 0x2F	0xFD97	FIR Filter Bank C, Coefficient 22
FIR_COEF_C23	R/W	Yes	0x03	0x30, 0x31	0xFCDD	FIR Filter Bank C, Coefficient 23
FIR_COEF_C24	R/W	Yes	0x03	0x32, 0x33	0xFD5D	FIR Filter Bank C, Coefficient 24
FIR_COEF_C25	R/W	Yes	0x03	0x34, 0x35	0xFE74	FIR Filter Bank C, Coefficient 25
FIR_COEF_C26	R/W	Yes	0x03	0x36, 0x37	0xFF8D	FIR Filter Bank C, Coefficient 26
FIR_COEF_C27	R/W	Yes	0x03	0x38, 0x39	0x004D	FIR Filter Bank C, Coefficient 27
FIR_COEF_C28	R/W	Yes	0x03	0x3A, 0x3B	0x009A	FIR Filter Bank C, Coefficient 28
FIR_COEF_C29	R/W	Yes	0x03	0x3C, 0x3D	0x008F	FIR Filter Bank C, Coefficient 29
FIR_COEF_C30	R/W	Yes	0x03	0x3E, 0x3F	0x005A	FIR Filter Bank C, Coefficient 30
FIR_COEF_C31	R/W	Yes	0x03	0x40, 0x41	0x0025	FIR Filter Bank C, Coefficient 31
Reserved	N/A	N/A	0x03	0x42 to 0x7F	N/A	Reserved
PAGE_ID	R/W	No	0x04	0x00, 0x01	0x0004	Page identifier
FIR_COEF_D00	R/W	Yes	0x04	0x02, 0x03	0xFD94	FIR Filter Bank D, Coefficient 0
FIR_COEF_D01	R/W	Yes	0x04	0x04, 0x05	0xFD62	FIR Filter Bank D, Coefficient 1
FIR_COEF_D02	R/W	Yes	0x04	0x06, 0x07	0xFD2A	FIR Filter Bank D, Coefficient 2
FIR_COEF_D03	R/W	Yes	0x04	0x08, 0x09	0xFCE8	FIR Filter Bank D, Coefficient 3
FIR_COEF_D04	R/W	Yes	0x04	0x0A, 0x0B	0xFC9C	FIR Filter Bank D, Coefficient 4
FIR_COEF_D05	R/W	Yes	0x04	0x0C, 0x0D	0xFC43	FIR Filter Bank D, Coefficient 5

Register Name	R/W	Flash Backup	PAGE_ID	Address	Default	Register Description
FIR_COEF_D06	R/W	Yes	0x04	0x0E, 0x0F	0xFBD7	FIR Filter Bank D, Coefficient 6
FIR_COEF_D07	R/W	Yes	0x04	0x10, 0x11	0xFB52	FIR Filter Bank D, Coefficient 7
FIR_COEF_D08	R/W	Yes	0x04	0x12, 0x13	0xFAAB	FIR Filter Bank D, Coefficient 8
FIR_COEF_D09	R/W	Yes	0x04	0x14, 0x15	0xF9D2	FIR Filter Bank D, Coefficient 9
FIR_COEF_D10	R/W	Yes	0x04	0x16, 0x17	0xF8AB	FIR Filter Bank D, Coefficient 10
FIR_COEF_D11	R/W	Yes	0x04	0x18, 0x19	0xF702	FIR Filter Bank D, Coefficient 11
FIR_COEF_D12	R/W	Yes	0x04	0x1A, 0x1B	0xF468	FIR Filter Bank D, Coefficient 12
FIR_COEF_D13	R/W	Yes	0x04	0x1C, 0x1D	0xEFBC	FIR Filter Bank D, Coefficient 13
FIR_COEF_D14	R/W	Yes	0x04	0x1E, 0x1F	0xE4DC	FIR Filter Bank D, Coefficient 14
FIR_COEF_D15	R/W	Yes	0x04	0x20, 0x21	0xAE85	FIR Filter Bank D, Coefficient 15
FIR_COEF_D16	R/W	Yes	0x04	0x22, 0x23	0x517B	FIR Filter Bank D, Coefficient 16
FIR_COEF_D17	R/W	Yes	0x04	0x24, 0x25	0x1B24	FIR Filter Bank D, Coefficient 17
FIR_COEF_D18	R/W	Yes	0x04	0x26, 0x27	0x1044	FIR Filter Bank D, Coefficient 18
FIR_COEF_D19	R/W	Yes	0x04	0x28, 0x29	0x0B98	FIR Filter Bank D, Coefficient 19
FIR_COEF_D20	R/W	Yes	0x04	0x2A, 0x2B	0x08FE	FIR Filter Bank D, Coefficient 20
FIR_COEF_D21	R/W	Yes	0x04	0x2C, 0x2D	0x0755	FIR Filter Bank D, Coefficient 21
FIR_COEF_D22	R/W	Yes	0x04	0x2E, 0x2F	0x062E	FIR Filter Bank D, Coefficient 22
FIR_COEF_D23	R/W	Yes	0x04	0x30, 0x31	0x0555	FIR Filter Bank D, Coefficient 23
FIR_COEF_D24	R/W	Yes	0x04	0x32, 0x33	0x04AE	FIR Filter Bank D, Coefficient 24
FIR_COEF_D25	R/W	Yes	0x04	0x34, 0x35	0x0429	FIR Filter Bank D, Coefficient 25
FIR_COEF_D26	R/W	Yes	0x04	0x36, 0x37	0x03BD	FIR Filter Bank D, Coefficient 26
FIR_COEF_D27	R/W	Yes	0x04	0x38, 0x39	0x0364	FIR Filter Bank D, Coefficient 27
FIR_COEF_D28	R/W	Yes	0x04	0x3A, 0x3B	0x0318	FIR Filter Bank D, Coefficient 28
FIR_COEF_D29	R/W	Yes	0x04	0x3C, 0x3D	0x02D6	FIR Filter Bank D, Coefficient 29
FIR_COEF_D30	R/W	Yes	0x04	0x3E, 0x3F	0x029E	FIR Filter Bank D, Coefficient 30
FIR_COEF_D31	R/W	Yes	0x04	0x40, 0x41	0x026C	FIR Filter Bank D, Coefficient 31
Reserved	N/A	N/A	0x04	0x42 to 0x7F	N/A	Reserved
PAGE_ID	R/W	No	0x05	0x00, 0x01	0x0005	Page identifier
FIR_COEF_E00	R/W	Yes	0x05	0x02, 0x03	0xFF2B	FIR Filter Bank E, Coefficient 0
FIR_COEF_E01	R/W	Yes	0x05	0x04, 0x05	0xFEFO	FIR Filter Bank E, Coefficient 1
FIR_COEF_E02	R/W	Yes	0x05	0x06, 0x07	0xFEAA	FIR Filter Bank E, Coefficient 2
FIR_COEF_E03	R/W	Yes	0x05	0x08, 0x09	0xFE59	FIR Filter Bank E, Coefficient 3
FIR_COEF_E04	R/W	Yes	0x05	0x0A, 0x0B	0xFDFB	FIR Filter Bank E, Coefficient 4
FIR_COEF_E05	R/W	Yes	0x05	0x0C, 0x0D	0xFD8C	FIR Filter Bank E, Coefficient 5
FIR_COEF_E06	R/W	Yes	0x05	0x0E, 0x0F	0xFD09	FIR Filter Bank E, Coefficient 6
FIR_COEF_E07	R/W	Yes	0x05	0x10, 0x11	0xFC6B	FIR Filter Bank E, Coefficient 7
FIR_COEF_E08	R/W	Yes	0x05	0x12, 0x13	0xFBA8	FIR Filter Bank E, Coefficient 8
FIR_COEF_E09	R/W	Yes	0x05	0x14, 0x15	0xFAB1	FIR Filter Bank E, Coefficient 9
FIR_COEF_E10	R/W	Yes	0x05	0x16, 0x17	0xF96B	FIR Filter Bank E, Coefficient 10
FIR_COEF_E11	R/W	Yes	0x05	0x18, 0x19	0xF7A1	FIR Filter Bank E, Coefficient 11
FIR_COEF_E12	R/W	Yes	0x05	0x1A, 0x1B	0xF4E5	FIR Filter Bank E, Coefficient 12
FIR_COEF_E13	R/W	Yes	0x05	0x1C, 0x1D	0xF017	FIR Filter Bank E, Coefficient 13
FIR_COEF_E14	R/W	Yes	0x05	0x1E, 0x1F	0xE512	FIR Filter Bank E, Coefficient 14
FIR_COEF_E15	R/W	Yes	0x05	0x20, 0x21	0xAE97	FIR Filter Bank E, Coefficient 15
FIR_COEF_E16	R/W	Yes	0x05	0x22, 0x23	0x5169	FIR Filter Bank E, Coefficient 16
FIR_COEF_E17	R/W	Yes	0x05	0x24, 0x25	0x1AEE	FIR Filter Bank E, Coefficient 17
FIR_COEF_E18	R/W	Yes	0x05	0x26, 0x27	0x0FE9	FIR Filter Bank E, Coefficient 18
FIR_COEF_E19	R/W	Yes	0x05	0x28, 0x29	0x0B1B	FIR Filter Bank E, Coefficient 19
FIR_COEF_E20	R/W	Yes	0x05	0x2A, 0x2B	0x085F	FIR Filter Bank E, Coefficient 20
FIR_COEF_E21	R/W	Yes	0x05	0x2C, 0x2D	0x0695	FIR Filter Bank E, Coefficient 21
FIR_COEF_E22	R/W	Yes	0x05	0x2E, 0x2F	0x054F	FIR Filter Bank E, Coefficient 22
FIR_COEF_E23	R/W	Yes	0x05	0x30, 0x31	0x0458	FIR Filter Bank E, Coefficient 23
FIR_COEF_E24	R/W	Yes	0x05	0x32, 0x33	0x0395	FIR Filter Bank E, Coefficient 24

Register Name	R/W	Flash Backup	PAGE_ID	Address	Default	Register Description
FIR_COEF_E25	R/W	Yes	0x05	0x34, 0x35	0x02F7	FIR Filter Bank E, Coefficient 25
FIR_COEF_E26	R/W	Yes	0x05	0x36, 0x37	0x0274	FIR Filter Bank E, Coefficient 26
FIR_COEF_E27	R/W	Yes	0x05	0x38, 0x39	0x0205	FIR Filter Bank E, Coefficient 27
FIR_COEF_E28	R/W	Yes	0x05	0x3A, 0x3B	0x01A7	FIR Filter Bank E, Coefficient 28
FIR_COEF_E29	R/W	Yes	0x05	0x3C, 0x3D	0x0156	FIR Filter Bank E, Coefficient 29
FIR_COEF_E30	R/W	Yes	0x05	0x3E, 0x3F	0x0110	FIR Filter Bank E, Coefficient 30
FIR_COEF_E31	R/W	Yes	0x05	0x40, 0x41	0x00D5	FIR Filter Bank E, Coefficient 31
Reserved	N/A	N/A	0x05	0x42 to 0x7F	N/A	Reserved
PAGE_ID	R/W	No	0x06	0x00, 0x01	0x0006	Page identifier
FIR_COEF_F00	R/W	Yes	0x06	0x02, 0x03	0xFFD9	FIR Filter Bank F, Coefficient 0
FIR_COEF_F01	R/W	Yes	0x06	0x04, 0x05	0xFFB9	FIR Filter Bank F, Coefficient 1
FIR_COEF_F02	R/W	Yes	0x06	0x06, 0x07	0xFF8C	FIR Filter Bank F, Coefficient 2
FIR_COEF_F03	R/W	Yes	0x06	0x08, 0x09	0xFF50	FIR Filter Bank F, Coefficient 3
FIR_COEF_F04	R/W	Yes	0x06	0x0A, 0x0B	0xFF02	FIR Filter Bank F, Coefficient 4
FIR_COEF_F05	R/W	Yes	0x06	0x0C, 0x0D	0xFE9E	FIR Filter Bank F, Coefficient 5
FIR_COEF_F06	R/W	Yes	0x06	0x0E, 0x0F	0xFE1F	FIR Filter Bank F, Coefficient 6
FIR_COEF_F07	R/W	Yes	0x06	0x10, 0x11	0xFD7D	FIR Filter Bank F, Coefficient 7
FIR_COEF_F08	R/W	Yes	0x06	0x12, 0x13	0xFCB0	FIR Filter Bank F, Coefficient 8
FIR_COEF_F09	R/W	Yes	0x06	0x14, 0x15	0xFBA8	FIR Filter Bank F, Coefficient 9
FIR_COEF_F10	R/W	Yes	0x06	0x16, 0x17	0xFA49	FIR Filter Bank F, Coefficient 10
FIR_COEF_F11	R/W	Yes	0x06	0x18, 0x19	0xF861	FIR Filter Bank F, Coefficient 11
FIR_COEF_F12	R/W	Yes	0x06	0x1A, 0x1B	0xF581	FIR Filter Bank F, Coefficient 12
FIR_COEF_F13	R/W	Yes	0x06	0x1C, 0x1D	0xF089	FIR Filter Bank F, Coefficient 13
FIR_COEF_F14	R/W	Yes	0x06	0x1E, 0x1F	0xE558	FIR Filter Bank F, Coefficient 14
FIR_COEF_F15	R/W	Yes	0x06	0x20, 0x21	0xAEAF	FIR Filter Bank F, Coefficient 15
FIR_COEF_F16	R/W	Yes	0x06	0x22, 0x23	0x5151	FIR Filter Bank F, Coefficient 16
FIR_COEF_F17	R/W	Yes	0x06	0x24, 0x25	0x1AA8	FIR Filter Bank F, Coefficient 17
FIR_COEF_F18	R/W	Yes	0x06	0x26, 0x27	0x0F77	FIR Filter Bank F, Coefficient 18
FIR_COEF_F19	R/W	Yes	0x06	0x28, 0x29	0x0A7F	FIR Filter Bank F, Coefficient 19
FIR_COEF_F20	R/W	Yes	0x06	0x2A, 0x2B	0x079F	FIR Filter Bank F, Coefficient 20
FIR_COEF_F21	R/W	Yes	0x06	0x2C, 0x2D	0x05B7	FIR Filter Bank F, Coefficient 21
FIR_COEF_F22	R/W	Yes	0x06	0x2E, 0x2F	0x0458	FIR Filter Bank F, Coefficient 22
FIR_COEF_F23	R/W	Yes	0x06	0x30, 0x31	0x0350	FIR Filter Bank F, Coefficient 23
FIR_COEF_F24	R/W	Yes	0x06	0x32, 0x33	0x0283	FIR Filter Bank F, Coefficient 24
FIR_COEF_F25	R/W	Yes	0x06	0x34, 0x35	0x01E1	FIR Filter Bank F, Coefficient 25
FIR_COEF_F26	R/W	Yes	0x06	0x36, 0x37	0x0162	FIR Filter Bank F, Coefficient 26
FIR_COEF_F27	R/W	Yes	0x06	0x38, 0x39	0x00FE	FIR Filter Bank F, Coefficient 27
FIR_COEF_F28	R/W	Yes	0x06	0x3A, 0x3B	0x00B0	FIR Filter Bank F, Coefficient 28
FIR_COEF_F29	R/W	Yes	0x06	0x3C, 0x3D	0x0074	FIR Filter Bank F, Coefficient 29
FIR_COEF_F30	R/W	Yes	0x06	0x3E, 0x3F	0x0047	FIR Filter Bank F, Coefficient 30
FIR_COEF_F31	R/W	Yes	0x06	0x40, 0x41	0x0027	FIR Filter Bank F, Coefficient 31
Reserved	N/A	N/A	0x06	0x42 to 0x7F	N/A	Reserved

¹ N/A means not applicable.

² The PAGE_ID register can be written to change the target register location but does not change values on the defined page in the PAGE_ID register.

³ The default value is valid until the first capture event, when the measurement data replaces the default value.

⁴ For these registers, values can be stored in flash but are not available for readback until ALM_PNTR is set.

⁵ Register values can be retrieved from records stored in flash using record retrieve commands.

USER REGISTER DETAILS

PAGE_ID, PAGE NUMBER

The contents in the PAGE_ID register (see Table 20 and Table 21) contain the current page setting. The ADcmXL1021-1 has output and control registers split over seven pages, numbered from zero to six. Page 1 to Page 6 are the configurable filter coefficients. Page 0 contains user registers for various configuration options and outputs.

As an example, write 0x8002 to select Page 2 for SPI-based user access. After the register map is pointed to Page 2, any register writes are used to configure the Filter Bank B coefficients. The ADcmXL1021-1 user register map (see Table 19) provides a functional summary of each page and the page assignments associated with each user accessible register.

Table 20. PAGE_ID Register Definition

Page ¹	Addresses	Default	Access	Flash Backup
0x0000	0x00, 0x01	0x0000	R/W	No

¹ This register is located at Address 0x00 and Address 0x01 of each page.

Table 21. PAGE_ID Bit Descriptions

Bits	Description
[15:0]	Page number, binary numerical format

TEMP_OUT, INTERNAL TEMPERATURE

The TEMP_OUT register (see Table 22 and Table 23) provides a measurement (uncalibrated) of the temperature inside of the unit at the conclusion of a data capture or analysis event, when the ADcmXL1021-1 is operating in the MFFT, AFFT, or MTC mode of operation (see Table 47). Table 24 shows several examples of the data format for the TEMP_OUT register. The TEMP_OUT value is related to the sensed temperature by the following relationship:

$$TEMP_OUT = (Temperature - 460^{\circ}C) / (-0.46^{\circ}C/LSB)$$

Table 22. TEMP_OUT Register Definition

Page	Addresses	Default	Access	Flash Backup
0x00	0x02, 0x03	0x8000 ¹	R	No

¹ The default value is valid until the first capture event, when the measurement data replaces the default value.

Table 23. TEMP_OUT Bit Definitions

Bits	Description
[15:0]	Internal temperature data. Offset binary format is twos complement, 1 LSB = -0.46°C, and there is an offset of +460°C, except in RTC mode.

Table 24. TEMP_OUT Data Format Examples

Temperature	Decimal	Hexadecimal	Binary
+105°C	772	0x0303	0000 0011 0000 0011
+60°C	870	0x0365	0000 0011 0110 0101
+20°C	957	0x03BC	0000 0011 1011 1100
+0°C	1000	0x03E8	0000 0011 1110 1000
-40°C	1087	0x043F	0000 0100 0011 1111

SUPPLY_OUT, POWER SUPPLY VOLTAGE

The SUPPLY_OUT register (see Table 25 and Table 26) provides a measurement (uncalibrated) of the voltage between the VDD and GND pins at the start of a data capture event, when the ADcmXL1021-1 is operating in the MFFT, AFFT, or MTC mode of operation (see Table 47). Table 27 shows several examples of the data format for the SUPPLY_OUT register.

Table 25. SUPPLY_OUT Register Definition

Page	Addresses	Default	Access	Flash Backup
0x00	0x04, 0x05	0x8000 ¹	R	No

¹ Default value is valid until the first capture event, when the measurement data replaces the default value

Table 26. SUPPLY_OUT Bit Descriptions

Bits	Description
[15:12]	Do not use
[11:0]	Voltage between VDD and GND pins. 0x0000 = 0 V, 1 LSB = 3.22 mV.

Table 27. Power Supply Data Format Examples

Supply Level (V)	LSB	Hexadecimal	Binary
3.6	1117	0x45D	0100 0101 1101
3.3 + 0.003226	1025	0x401	0100 0000 0001
3.3	1024	0x400	0100 0000 0000
3.3 - 0.003226	1023	0x3FF	0011 1111 1111
3.0	930	0x3A2	0011 1010 0010

FFT_AVG1, SPECTRAL AVERAGING

The FFT_AVG1 register (see Table 28 and Table 29) contains the user-configurable, spectral averaging settings for the SR0 and SR1 sample rate settings (see the AVG_CNT register in Table 68). These settings determine the number of FFT records that the ADcmXL1021-1 averages when generating the final FFT result. When using the factory default value for the FFT_AVG1 register, the FFT result for the sample rate, SR0, contains an average of eight separate FFT records. The FFT result for the SR1 sample rate contains a single FFT record (no spectral averaging).

Increasing the number of FFT averages increases the overall time for a record to be generated. The FFT averaging sequence is as follows: 4096 samples are measured, FFT on 4096 samples, accumulate FFT result, repeat until the number of FFTs specified in FFT_AVG1 or FFT_AVG2 is reached. Then, compute the average FFT, average power supply, and average temperature. The power supply and temperature are measured after the 4096 samples are captured each time and accumulated.

Table 28. FFT_AVG1 Register Definition

Addresses	Default	Access	Flash Backup
0x06, 0x07	0x0108	R/W	Yes

Table 29. FFT_AVG1 Bit Descriptions

Bits	Description
[15:8]	Number of records, SR1, 8 bit unsigned format, range: 1 to 255
[7:0]	Number of records, SR0, 8 bit unsigned format, range: 1 to 255

To eliminate averaging on both SR0 and SR1 settings, set FFT_AVG1 = 0x0101 by using the following codes (in order) for the DIN serial string: 0x8601 and 0x8701. Table 30 shows three more examples of FFT_AVG1 settings, the number of records that each setting corresponds to that produces each FFT_AVG1 value.

Table 30. FFT_AVG1 Formatting Examples

FFT_AVG1 Value	Number of FFT Records	
	SR0	SR1
0x040C	12	4
0x0E1A	26	14
0xFF42	66	255

FFT_AVG2, SPECTRAL AVERAGING

The FFT_AVG2 register (see Table 31 and Table 32) contains the user-configurable, spectral averaging settings for the SR2 and SR3 sample rate settings (see the AVG_CNT register in Table 68). These settings determine the number of FFT records that the ADcmXL1021-1 averages when generating the final FFT result. When using the factory default value for the FFT_AVG2 register, the FFT result for the SR2 and SR3 sample rates contains a single FFT record (no spectral averaging).

Table 31. FFT_AVG2 Register Definition

Addresses	Default	Access	Flash Backup
0x08, 0x09	0x0101	R/W	Yes

Table 32. FFT_AVG2 Bit Descriptions

Bits	Description
[15:8]	Number of records, SR3, 8 bit unsigned format, range: 1 to 255
[7:0]	Number of records, SR2, 8 bit unsigned format, range: 1 to 255

To configure the ADcmXL1021-1 to average two FFT records for both SR2 and SR3 settings, set FFT_AVG2 = 0x0202 by using the following codes (in order) for the DIN serial string: 0x8802 and 0x8702. Table 33 shows three more examples of FFT_AVG2 settings, the number of records that each setting corresponds to, and the DIN code sequence that produces each FFT_AVG2 value.

Table 33. FFT_AVG2 Formatting Examples

FFT_AVG2 Value	Number of FFT Records	
	SR2	SR3
0x0407	7	4
0x0D50	80	13
0x2FFA	250	47

BUF_PNTR, BUFFER POINTER

The BUF_PNTR (see Table 34 and Table 35) controls the data sample that loads to the OUT_BUF register (see Table 39) from the user data buffers. The BUF_PNTR register contains 0x0000 at the conclusion of each capture event and increments with each read of the OUT_BUF register. When BUF_PNTR contains the maximum value (2047 or 4095, see Table 35), the next increment (caused by a read request OUT_BUF) causes the value in the BUF_PNTR register to wrap around to 0x0000. The depth of the user data buffer and, therefore, the range of numbers that BUF_PNTR supports, depends on the mode of operation, according to the setting in the REC_CTRL register, Bit 0 and Bit 1 (see Table 47).

Table 34. BUF_PNTR Register Definition

Addresses	Default	Access	Flash Backup
0x0A, 0x0B	0x0000	R/W	No

Table 35. BUF_PNTR Bit Descriptions

Bits	Description
[15:12]	Set these bits to 0, when writing to this register.
[11:0]	Buffer pointer value. Range = 0 to 2047 (in MFFT mode or AFFT mode). Range = 0 to 4095 (in MTC mode).

Writing a number to the BUF_PNTR register causes that sample number for user data buffer to load to the OUT_BUF register. For example, using the following code sequence on DIN writes 0x031C to the BUF_PNTR register: 0x8A1C and 0x8B03. This write causes the sample pointer to output (796) from the user data buffer to load to OUT_BUF (see Figure 43).

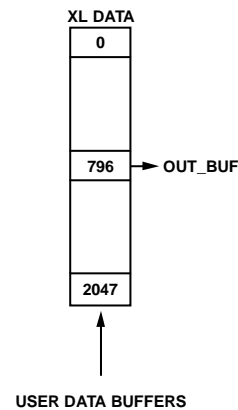

Figure 43. Register Activity, BUF_PNTR = 0x031C (MFFT Mode or AFFT Mode)

REC_PNTR, RECORD POINTER

The REC_PNTR register (see Table 36 and Table 37) provides access to the statistical metrics from MTC capture events and spectral records from MFFT or AFFT capture events in the data storage bank. Each spectral analysis record in the data storage bank has a number from 0 to 9 that identifies the number to write to the REC_PNTR register, Bits[3:0]. This write loads that spectral record to the user data buffers. After the data from the spectral record is in the user data buffers, the BUF_PNTR register (see Table 35) and OUT_BUF register (see Table 39) provide access to the data in the specified data record through the SPI. For example, using the following DIN codes to set REC_PNTR = 0x0007 causes Spectral Record 7 to load to the user data buffers. See Table 38 for additional examples.

Each statistical record in the data storage bank has a number from 0 through 31 that identifies the number to write to the REC_PNTR register, Bits[12:8]. This write loads that statistical record to the user statistical buffers. After the data from a statistical record is in the user statistical buffers, the STAT_PNTR register (see Table 105), statistic register (see Table 107) provide access to this data through the SPI. For example, using the following DIN codes to set REC_PNTR = 0x0B00 causes Statistical Record 11 to load to the user statistical buffers: 0x8C00 and 0x8D0B. See Table 38 for additional examples.

Table 36. REC_PNTR Register Definition

Addresses	Default	Access	Flash Backup
0x0C, 0x0D	0x0000	R/W	No

Table 37. REC_PNTR Bit Descriptions

Bits	Description
[15:12]	Set these bits to 0 when writing to this register
[12:8]	Record number, statistics (from MTC mode only), range = 0 to 31
[7:4]	Set these bits to 0 when writing to this register
[3:0]	Record number, spectral records, range = 0 to 9 (from MFFT mode and AFFT mode only)

Table 38. REC_PNTR Example Use Cases

DIN Codes	REC_PNTR Value	Description
0x8C05	0x0005	Spectral Record 5 loads to the user data buffer.
0x8D0C	0x0C00	Statistical Record 12 loads to the user statistics buffer.
0x8C03, 0x8D15	0x1503	Spectral Record 3 loads to the user data buffer and Statistical Record 21 loads to the user statistics buffer.

OUT_BUF, BUFFER ACCESS REGISTER

The OUT_BUF register (see Table 39 and Table 40) provides access to vibration data. When operating in MTC, MFFT, or AFFT mode, OUT_BUF contains the accelerometer data sample from the user data buffer, which the BUF_PNTR register (see Table 35) commands. In RTS mode, data is streamed out from the SPI interface, and data buffers of the registers are not used.

In modes other than RTS when data is stored, after a read of the upper byte and lower byte, the buffer automatically updates with the next data sample in the internal buffer, the BUF_PNTR is auto-incremented. For MTC mode, the buffer can support 4096 time domain samples, and BUF_PNTR can advance from 0 to 4095. For AFFT and MFFT mode, the buffer supports 2048 FFT bin values, and BUF_PNTR can advance from 0 to 2047.

Table 39. OUT_BUF Register Definition

Addresses	Default ¹	Access	Flash Backup
0x12, 0x13	0x8000	R/W	No

¹ The default value changes to 0x8000 when entering the first capture event and is only valid until completion of the first capture event or commencement of RTS mode.

Table 40. OUT_BUF Bit Descriptions

Bits	Description
[15:0]	Output data

The numerical format of the data in OUT_BUF depends on the mode of operation (see the REC_CTRL register, Bits[1:0] in Table 47). When operating in MTC mode (REC_CTRL, Bits[1:0] = 10), the data in the OUT_BUF register uses a 16-bit, offset binary format, where 1 LSB represents ~0.001907 g. This format provides enough numerical range to support the measurement range (± 50 g) and the maximum bias/offset from the core sensor. Table 41 shows several examples of how to translate these codes to the acceleration magnitude that the examples represent for MTC mode, assuming nominal sensitivity and zero bias error.

MTC mode data in the OUT_BUF register uses a 16-bit, twos complement format, where 1 LSB represents ~0.001907 g. This format provides enough numerical range to support the measurement range (± 50 g) and the maximum bias and offset from the core sensor. Table 41 shows several examples of how to translate these codes into the acceleration magnitude that the codes represent, assuming nominal sensitivity and zero bias error.

If velocity calculations are enabled using Bit 5 in the REC_CTRL register, calculated velocity data is stored in place of default acceleration value. Data format examples are shown in Table 42.

Table 41. MTC Mode Data Format Examples

Acceleration (g)	LSB	Hexadecimal	Binary
+62.4867	+32,767	0x7FFF	0111 1111 1111 1111
+50	+26,219	0x666B	0110 0110 0110 1011
+0.003814	+2	0x0002	0000 0000 0000 0010
+0.001907	+1	0x0001	0000 0000 0000 0001
0	0	0x0000	0000 0000 0000 0000
-0.001907	-1	0xFFFF	1111 1111 1111 1111
-0.003814	-2	0xFFFE	1111 1111 1111 1110
-50	-26,220	0x9995	1001 1001 1001 0101
-62.4886	-32,768	0x8000	1000 0000 0000 0000

Table 42. MTC Mode Data Format Examples, Velocity Calculations Enabled

Velocity (mm/sec)	LSB	Hexadecimal	Binary
+610,121.5	+32,767	0x7FFF	0111 1111 1111 1111
+487,844	+26,200	0x6658	0110 0110 0101 1000
+37.24	+2	0x0002	0000 0000 0000 0010
+18.62	+1	0x0001	0000 0000 0000 0001
0	0	0x0000	0000 0000 0000 0000
-18.62	-1	0xFFFF	1111 1111 1111 1111
-37.24	-2	0xFFFE	1111 1111 1111 1110
-487,844	-26,200	0x99A8	1001 1001 1010 0111
-610,121.5	-32,768	0x8000	1000 0000 0000 0000

When operating in the FFT modes, either MFFT mode (REC_CTRL1, Bits[1:0] = 00) or AFFT mode (REC_CTRL, Bits[1:0] = 01), the OUT_BUF register uses a 16-bit, unsigned binary format. Due to the increased resolution capability of FFT values because of averaging, converting the OUT_BUF value to acceleration is accomplished by using the following equation:

$$Output (mg) = \left(\frac{2^{\left(\frac{OUT_BUF}{2048} \right)}}{Number\ of\ FFT\ Averages} \right) \times 0.9535\ mg$$

Table 43 shows the conversion from OUT_BUF value to acceleration.

Table 43. Spectral Analysis Data Format Examples

Acceleration (mg)	OUT_BUF Value	Number of FFT Averages
62467.43	32767	1
6766.87	26200	1
1.02	200	1
0.95	1	1
64377.71	39000	8
3060.90	30000	8
0.12	8	8
0.95	2048	2
1.91	2048	1

ANULL, BIAS CALIBRATION REGISTER

The ANULL register (see Table 44 and Table 45) contains the bias correction value for the accelerometer, which the auto-null command (see the GLOB_CMD register, Bit 0, in Table 73) generates. The ANULL register also supports write access, which enables users to write their own correction factors to the output signal chain. The numerical format examples from Table 41 also apply to the ANULL register. For example, writing the following codes to DIN sets ANULL = 0xFDDE, which adjusts the offset of the output signal chain by -546 LSB (~1.042 g = 1 g ÷ 524 LSBs × 546 LSBs): 0x98DE and 0x99FD.

Table 44. ANULL Register Definition

Addresses	Default	Access	Flash Backup
0x18, 0x19	0x0000	R/W	Yes

Table 45. ANULL Bit Descriptions

Bits	Description
[15:0]	Bias correction factor. Twos complement, 1 LSB = 0.001907 g.

REC_CTRL, RECORDING CONTROL

The REC_CTRL register (see Table 46 and Table 47) contains the configuration bits for a number of operational settings in the ADcmXL1021-1: mode of operation, record storage, power management, sample rates, and windowing.

Table 46. REC_CTRL Register Definitions

Addresses	Default	Access	Flash Backup
0x1A, 0x1B	0x1102	R/W	Yes

Table 47. REC_CTRL Bit Descriptions

Bits	Description
15	Real-time streaming timeout enable.
14	Not used.
[13:12]	Window setting (MFFT mode and AFFT modes only). 00 = rectangular. 01 = Hanning (default). 10 = flat top. 11 = not applicable.
11	SR3, Sample Rate Option 3, enable = 1, disable = 0. Sample rate = 220 kSPS ÷ 2 ^{AVG_CNT[15:12]} (see Table 68).
10	SR2, Sample Rate Option 2, enable = 1, disable = 0. Sample rate = 220 kSPS ÷ 2 ^{AVG_CNT[11:8]} (see Table 68).
9	SR1, Sample Rate Option 1, enable = 1, disable = 0. Sample rate = 220 kSPS ÷ 2 ^{AVG_CNT[7:4]} (see Table 68).
8	SR0, Sample Rate Option 0, enable = 1, disable = 0. Sample rate = 220 kSPS ÷ 2 ^{AVG_CNT[3:0]} (see Table 68).
7	Automatic power-down between recordings (MFFT, AFFT, and MTC mode only). Requires a CS toggle to wake up. 0 = no power-down. 1 = power-down after data collection/processing.

Bits	Description
6	Enable compute statistics in MTC mode.
5	Enable velocity calculations. 0 = acceleration. 1 = calculated velocity.
4	Reserved.
[3:2]	Flash memory record storage method (MFFT, AFFT, and MTC modes only). 00 = none. No record storage to flash memory, current data is available in SRAM until the next recording event is stored. 01 = alarm triggered. Record storage occurs when the vibration exceeds one of the configurable alarm settings. 10 = all. Record storage happens at the conclusion of each data collection and processing event. 11 = reserved.
[1:0]	Recording mode. 00 = MFFT mode. 01 = AFFT mode. 10 = MTC mode. 11 = RTS mode.

Real-Time Burst Mode Timeout Enabled

Bit 15 in the REC_CTRL register (see Table 47) contains the settings that independently disable RTS mode if the available data is not read. By default, RTS mode is enabled and disabled via the digital pin, RTS. If this bit is enabled, RTS mode is halted after failure to receive SCLK on five consecutive data ready active periods.

Windowing

Bits[13:12] in the REC_CTRL register (see Table 47) contain the settings for the window function that the ADcmXL1021-1 uses on the time domain data, prior to performing the FFT. The factory default setting for these bits (01) selects the Hanning window function. The other window options available are rectangular (setting 0b00), or flat top (setting 0b10).

Spectral Record Selection

Bits[11:8] in the REC_CTRL register (see Table 47) contain on and off settings for the four different sample rate options that are set using the AVG_CNT register.

The sample rate selector bits (SR0, SR1, SR2, and SR3) are used when operating in MFFT, AFFT, or MTC mode. When only one of these bits is set to 1, every data capture event uses that sample rate setting. When two of the bits are set to 1, the ADcmXL1021-1 uses one of the sample rates for one data capture event, and then switches to the other for the next capture event. When all four bits are set to 1, the ADcmXL1021-1 uses the sample rates in the following order when switching to a new sample rate for each new capture events: SR0, SR1, SR2, SR3, SR0, SR1, and so on.

Automatic Power-Down

Bit 7 in the REC_CTRL register (see Table 47) contains the setting for the automated power-down function when the ADcmXL1021-1 is operating in MFFT, AFFT, or MTC mode. When this bit is set to 1, the ADcmXL1021-1 automatically powers down after completing data collection and processing. When this bit is set to 0, the ADcmXL1021-1 does not power down after completing data collection and processing functions. After the device is in sleep mode, a CS toggle is required to wake up before the next measurement can be used. If the device is powered down between records in AFFT mode, wake up occurs automatically before the next capture.

Calculate MTC Statistics

Bit 6 in the REC_CTRL register (see Table 47) contains the setting to enable statistic calculation on MTC records

Calculate Velocity

Bit 5 in the REC_CTRL register (see Table 47) contains the setting to convert accelerometer data values to velocity values. When this bit is set to 0, the user data buffers contain linear acceleration data. When this bit is set to 1, the user data buffers contain linear velocity data, which comes from integrating the acceleration data with respect to time.

Record Storage

Bits[3:2] in the REC_CTRL register (see Table 47) contain the settings that determine when the ADcmXL1021-1 stores the result of an FFT capture event to a record location. The MISC_CTRL register is used for storing time domain statistics.

Recording Mode

Bits[1:0] in the REC_CTRL register (see Table 47) establish the mode of operation. When operating in MTC mode, the ADcmXL1021-1 uses the signal processing diagram and user-accessible registers shown in Figure 27. When operating in AFFT and MFFT mode, the ADcmXL1021-1 uses the signal processing diagram and user-accessible registers shown in Figure 29.

REC_PRD, RECORD PERIOD

The REC_PRD register (see Table 48 and Table 49) contains the settings for the timer function that the ADcmXL1021-1 uses when operating in AFFT mode.

Table 48. REC_PRD Register Definition

Addresses	Default	Access	Flash Backup
0x1E, 0x1F	0x0000	R/W	Yes

Table 49. REC_PRD Bit Descriptions

Bits	Description
[15:10]	Don't care
[9:8]	Scale for data bits: 00 = 1 second/LSB, 01 = 1 minute/LSB, 10 = 1 hour/LSB
[7:0]	Data bits, binary format; range = 0 to 255

Setting REC_PRD to 0x0005 establishes a 5 sec setting for the time that elapses between the completion of one capture event and the beginning of the next capture event. Table 50 shows several more examples of configuration codes for the REC_PRD register.

Table 50. REC_PRD Example Use Cases

REC_PRD Value	Timer Value
0x0022	34 sec
0x010F	15 minutes
0x0218	24 hours

ALM_F_LOW, ALARM FREQUENCY BAND

Up to six individual spectral alarm bands can be specified with two magnitude alarm levels. The ALM_PNTR register setting identifies which alarm is currently addressed and being configured. Spectral alarms apply when the ADcmXL1021-1 is operating in MFFT or AFFT mode and when the ALM_F_LOW register (see Table 51 and Table 52) contains the number of the lowest FFT bin, which is included in the spectral alarm setting that the ALM_PNTR register (see Table 60) contains.

The value of ALM_F_LOW applies to the FFT spectral record. The exact frequency depends on AVG_CNT register because this register setting reduces the full FFT bandwidth.

Table 51. ALM_F_LOW Register Definition

Addresses	Default	Access	Flash Backup
0x20, 0x21	0x0000	R/W	Yes

Table 52. ALM_F_LOW Bit Descriptions

Bits	Description
[15:12]	Don't care
[11:0]	Lower frequency, bin number; range = 0 to 2047

For example, when setting ALR_F_LOW = 0x0064, the lower frequency of the alarm band starts at Bin 100. For example, if AVG_CNT = 8, the lower frequency is set to 600 Hz (600 Hz = (100 LSB × 220 kHz/8)/4096).

If AVG_CNT = 2, the lower frequency is 2400 Hz if ALM_F_LOW = 0x0064.

ALM_F_HIGH, ALARM FREQUENCY BAND

When the ADcmXL1021-1 is operating in MFFT or AFFT mode, the ALM_F_HIGH register (see Table 53 and Table 54) contains the number of the highest FFT bin included in the spectral alarm setting. The ALM_PNTR register (see Table 60) contains the information regarding which of the six alarms is being set.

Table 53. ALM_F_HIGH Register Definition

Addresses	Default	Access	Flash Backup
0x22, 0x23	0x0000	R/W	Yes

Table 54. ALM_F_HIGH Bit Descriptions

Bits	Description
[15:12]	Don't care
[11:0]	Upper frequency, bin number; range = 0 to 2047

The value of ALM_F_LOW applies to the FFT spectral record. The exact frequency depends on the AVG_CNT register because this setting reduces the full FFT bandwidth.

For example, when setting ALM_F_LOW = 0x0064, the lower frequency of the alarm band starts at Bin 200. For example, if AVG_CNT = 8, the lower frequency is set to 1200 Hz (1200 Hz = (200 LSB × 220 kHz/8)/4096).

If AVG_CNT = 2, the lower frequency is 4800 Hz if ALM_F_LOW = 0x0064.

ALM_MAG1, ALARM LEVEL 1

The ALM_MAG1 register sets a magnitude limit for the output in which to trigger an alarm warning. A second, higher trigger magnitude can be set in the ALM_MAG2 register and can distinguish between a warning condition vs. a more critical condition. When the ADcmXL1021-1 is operating in MFFT or AFFT mode, the ALM_MAG1 register (see Table 55 and Table 56) contains the magnitude of the vibration, which triggers Alarm 1 for the spectral alarm setting contained in the ALM_PNTR register (see Table 60). In this mode, the FFT band that is compared to the trigger magnitude limit is between ALM_L_LOW and ALM_F_HIGH.

When in MTC mode, this limit applies to the statistics of the time domain capture.

ALM_MAG1 can be used as a warning indicator and ALM_MAG2 as a critical alarm indicator. Set ALM_MAG2 to a greater or equal value as ALM_MAG1.

Table 55. ALM_MAG1 Register Definition

Addresses	Default	Access	Flash Backup
0x28, 0x29	0x0000	R/W	Yes

Table 56. ALM_MAG1 Bit Descriptions

Bits	Description
[15:0]	Alarm Trigger Level 1

The data format in the ALM_MAG1 register is the same as the data format in the OUT_BUF register. See Table 43 for several examples of this data format.

ALM_MAG2, ALARM LEVEL 2

When the ADcmXL1021-1 is operating in MFFT or AFFT mode, the ALM_MAG2 register (see Table 57 and Table 58) contains the magnitude of the vibration, which triggers Alarm 2 for the spectral alarm setting that the ALM_PNTR register (see Table 60) contains. When in MTC mode, this limit applies to the statistics of the time domain capture.

Table 57. ALM_MAG2 Register Definition

Addresses	Default	Access	Flash Backup
0x2E, 0x2F	0x0000	R/W	Yes

Table 58. ALM_MAG2 Bit Descriptions

Bits	Description
[15:0]	Alarm Trigger Level 2

The data format in the ALM_MAG2 register is the same as the data format in the OUT_BUF register. See Table 43 for several examples of this data format.

The Alarm 2 magnitudes must be greater than or equal to Alarm 1.

ALM_PNTR, ALARM POINTER

When the ADcmXL1021-1 is operating in MFFT or AFFT mode, the ALM_PNTR register (see Table 59 and Table 60) contains an alarm pointer that identifies a specific spectral alarm by sample rate (Bits[9:8]) and spectral band number (Bits[2:0]). Up to six alarms can be configured per sample rate setting.

Table 59. ALM_PNTR Register Definition

Addresses	Default	Access	Flash Backup
0x30, 0x31	0x0000	R/W	No

Table 60. ALM_PNTR Bit Descriptions

Bits	Description
[15:10]	Don't care
[9:8]	Indicates the sample rate setting for which Alarm x is defined 00 = SR0 01 = SR1 02 = SR2 03 = SR3
[7:3]	Don't care
[2:0]	Spectral band number (1, 2, 3, 4, 5, or 6)

Setting ALM_PNTR = 0x0203 provides access to the settings for the spectral alarm, which is associated with Sample Rate SR2 and Spectral Band 3. The current attributes from this spectral alarm load to the ALM_F_LOW, ALM_F_HIGH, ALM_MAG1 and ALM_MAG2 registers. Writing to these registers changes each setting for the spectral alarm, which is associated with Sample Rate SR2 and Spectral Band 3 as well.

ALM_S_MAG ALARM LEVEL

The ALM_S_MAG register (see Table 61 and Table 62) contains the magnitude of the system alarm, which can monitor the temperature or power supply level according to Bits[5:4] in the ALM_CTRL register (see Table 64).

Table 61. ALM_S_MAG Register Definition

Addresses	Default	Access	Flash Backup
0x32, 0x33	0x0000	R/W	No

Table 62. ALM_S_MAG Bit Descriptions

Bits	Description
[15:0]	System alarm setting

When Bit 4 in the ALM_CTRL register is equal to 0, the ALM_S_MAG register uses the same data format as the SUPPLY_OUT register (see Table 26 and Table 27). When Bit 4 in the ALM_CTRL register is equal to 1, the ALM_S_MAG register uses the same data format as the TEMP_OUT register (see Table 23 and Table 24).

ALM_CTRL, ALARM CONTROL

The ALM_CTRL register (see Table 63 and Table 64) contains a number of configuration settings for the alarm function.

Table 63. ALM_CTRL Register Definition

Addresses	Default	Access	Flash Backup
0x34, 0x35	0x0080	R/W	Yes

Table 64. ALM_CTRL Bit Descriptions

Bits	Description
[15:13]	Don't care.
[12]	Disables automatic clearing of spectral alarm status bits upon a read of the status register.
[11:8]	Response delay, range = 0 to 15. Represents the number of spectral records for each spectral alarm before a spectral alarm flag is set high.
7	Latch DIAG_STAT error flags. Requires a clear status command (GLOB_CMD, Bit 4) to reset the flags to 0. 1 = enabled, 0 = disabled.
6	Enable Alarm 1 and Alarm 2 on ALM1 and ALM2, respectively.
5	System alarm polarity. 1 = trigger when less than ALM_S_MAG. 0 = trigger when greater than ALM_S_MAG.
4	System alarm selection. 1 = temperature, 0 = power supply.
3	System alarm: 1 = enabled, 0 = disabled.
2	Output alarm: 1 = enabled, 0 = disabled.
1	Reserved.
0	Reserved.

FILT_CTRL, FILTER CONTROL

The FILT_CTRL register (see Table 65 and Table 66) provides configuration settings for the 32-tap, FIR filters. When the FILT_CTRL pin contains the factory default value, the ADcmXL1021-1 does not use any of the FIR filters on the output. For example, set DIN = 0xB871, then set DIN = 0xB901 to write 0x0171 to the FILT_CTRL register. This code (0x0171) selects Filter Bank 5 for the accelerometer output.

Table 65. FILT_CTRL Register Definition

Addresses	Default	Access	Flash Backup
0x38, 0x39	0x0000	R/W	Yes

Table 66. FILT_CTRL Bit Descriptions

Bits	Description
[15:11]	Don't care.
[10:8]	Output FIR filter selection. 110: FIR Filter Bank F (high-pass filter, 10 kHz). 101: FIR Filter Bank E (high-pass filter, 5 kHz). 100: FIR Filter Bank D (high-pass filter, 1 kHz). 011: FIR Filter Bank C (low-pass filter, 10 kHz). 010: FIR Filter Bank B (low-pass filter, 5 kHz). 001: FIR Filter Bank A (low-pass filter, 1 kHz). 000: no FIR selection.
[7:0]	Reserved.

AVG_CNT, DECIMATION CONTROL

The AVG_CNT register (see Table 67 and Table 68) provides four different sample rate settings (SR0, SR1, SR2, and SR3) that users can enable using Bits[11:8] in the REC_CTRL register (see Table 47). These sample rate settings only apply to MFFT, AFFT, and MTC mode.

Table 67. AVG_CNT Register Definition

Addresses	Default	Access	Flash Backup
0x3A, 0x3B	0x7421	R/W	Yes

Table 68. AVG_CNT Bit Descriptions

Bits	Description
[15:12]	SR3 sample rate scale factor (1 to 7), SR3 sample rate = $220,000 \div 2^{AVG_CNT[15:12]}$
[11:8]	SR2 sample rate scale factor (1 to 7), SR2 sample rate = $220,000 \div 2^{AVG_CNT[11:8]}$
[7:4]	SR1 sample rate scale factor (1 to 7), SR1 sample rate = $220,000 \div 2^{AVG_CNT[7:4]}$
[3:0]	SR0 sample rate scale factor (1 to 7), SR0 sample rate = $220,000 \div 2^{AVG_CNT[3:0]}$

Each nibble in the AVG_CNT register offers a setting for each sample rate setting: SR0, SR1, SR2, and SR3. The following formula demonstrates one of the sample rates (SR1) derived from the factory default value (0x7421) in the AVG_CNT register:

$$SR1 = 220,000 \div 2^2 = 55,000 \text{ SPS}$$

To change one of the sample rate values, write the control value to the specific nibble in the AVG_CNT register. For example, set DIN = 0xBB35 to set the upper byte of the AVG_CNT register to 0x35, which causes the SR2 sample rate to be 27,500 SPS and the SR3 sample rate to be 6,875 SPS.

In MFFT and AFFT mode, the sample rate settings in the AVG_CNT register influence the bin widths of each FFT result, which has an impact on the noise in each bin. Table 69 lists the SR0 sample rate settings (see the AVG_CNT register, Bits[3:0]), along

with the bin widths and noise predictions that come with those settings. The information in Table 69 also applies to the SR1 (AVG_CNT register, Bits[7:4]), SR2 (AVG_CNT register, Bits[11:8]), and SR3 (AVG_CNT register, Bits[15:12]) settings as well.

Table 69. SR0 Sample Rate Settings and Bin Widths

AVG_CNT, Bits[3:0]	Sample Rate (SPS)	Bin Width (Hz)
0	Not applicable	Not applicable
1 (Default)	220000	53.8
2	110000	26.9
3	55000	13.4
4	27500	6.71
5	13750	3.35
6	6875	1.68
7	3438.5	0.839

DIAG_STAT, STATUS, AND ERROR FLAGS

The DIAG_STAT (see Table 70 and Table 71) register contains a number of status flags.

Table 70. DIAG_STAT Register Definition

Addresses	Default	Access	Flash Backup
0x3C, 0x3D	0x0000	R	No

Table 71. DIAG_STAT Bit Descriptions

Bits	Description
15	Not used (don't care).
14	System alarm flag. The temperature or power supply exceeded the user configured alarm.
13	Spectral Alarm 2 flag.
12	Reserved.
11	Reserved.
10	Spectral Alarm 1 flag.
9	Reserved.
8	Reserved.
7	Data ready/busy indicator (0 = busy, 1 = data ready).
6	Flash test result, checksum flag (0 = no error, 1 = error).
5	Self test diagnostic error flag.
4	Recording escape flag. Indicates use of the SPI driven interruption command, 0x00E8. This flag is reset automatically after the first successful recording.
3	SPI communication failure (SCLKs \neq even multiple of 16).
2	Flash update failure.
1	Power supply > 3.625 V.
0	Power supply < 2.975 V.

GLOB_CMD, GLOBAL COMMANDS

The GLOB_CMD (see Table 72 and Table 73) register contains a number of global commands. To start any of these processes, set the corresponding bit to 1. For example, set Bit 0 to logic high to execute the autonull function and the bit self clears.

Table 72. GLOB_CMD Register Definition

Addresses	Default	Access	Flash Backup
0x3E, 0x3F	Not applicable	W	No

Table 73. GLOB_CMD Bit Descriptions

Bits	Description
15	Clear autonull correction.
14	Retrieve spectral alarm band information from the ALM_PNTR setting.
13	Retrieve record data from flash memory.
12	Save spectral alarm band registers to flash memory.
11	Record start or stop.
10	Set BUF_PNTR = 0x0000.
9	Clear spectral alarm band registers from flash memory.
8	Clear all records.
7	Software reset.
6	Save registers to flash memory.
5	Flash test, compare sum of flash memory with factory value.
4	Clear DIAG_STAT register once.
3	Restore factory register settings and clear the capture buffers.
2	Self test. Executes the automatic self test method. If test does not pass, then the self test diagnostic flag is set in the status register (Bit 5).
1	Power-down (wake with \overline{CS} toggle). Powers down sensor and puts embedded microcontroller in sleep mode. The device wakes up with a toggle of \overline{CS} or if the automatic timer triggers a new capture (automatic mode).
0	Autonull.

ALM_STAT, ALARM STATUS

The ALM_STAT (see Table 74 and Table 75) register contains status flags for alarm.

Table 74. ALM_STAT Register Definition

Addresses	Default	Access	Flash Backup
0x44, 0x45	0x0000	R	Yes

Table 75. ALM_STAT Bit Descriptions

Bits	Description
15	Alarm 2 on Band 6; 1 = alarm set, 0 = no alarm
14	Alarm 1 on Band 6; 1 = alarm set, 0 = no alarm
13	Alarm 2 on Band 5; 1 = alarm set, 0 = no alarm
12	Alarm 1 on Band 5; 1 = alarm set, 0 = no alarm
11	Alarm 2 on Band 4; 1 = alarm set, 0 = no alarm
10	Alarm 1 on Band 4; 1 = alarm set, 0 = no alarm
9	Alarm 2 on Band 3; 1 = alarm set, 0 = no alarm
8	Alarm 1 on Band 3; 1 = alarm set, 0 = no alarm
7	Alarm 2 on Band 2; 1 = alarm set, 0 = no alarm
6	Alarm 1 on Band 2; 1 = alarm set, 0 = no alarm
5	Alarm 2 on Band 1; 1 = alarm set, 0 = no alarm
4	Alarm 1 on Band 1; 1 = alarm set, 0 = no alarm
3	Not used
[2:0]	Most critical alarm condition, spectral band; range = 1 to 6

ALM_PEAK, ALARM PEAK LEVEL

The ALM_PEAK (see Table 76 and Table 77) register contains the magnitude of the FFT bin, which contains the peak alarm value.

Table 76. ALM_PEAK Register Definition

Addresses	Default	Access	Flash Backup
0x4A, 0x4B	0x0000	R	Yes

Table 77. ALM_PEAK Bit Descriptions

Bits	Description
[15:0]	Alarm peak, accelerometer data format

TIME_STAMP_L AND TIME_STAMP_H, DATA RECORD TIMESTAMP

The TIME_STAMP_L (see Table 78 and Table 79) and TIME_STAMP_H (see Table 80 and Table 81) registers contain a relative timestamp for the most recent data capture event.

Table 78. TIME_STAMP_L Register Definition

Addresses	Default	Access	Flash Backup
0x4C, 0x4D	0x0000	R	Yes

Table 79. TIME_STAMP_L Bit Descriptions

Bits	Description
[15:0]	Timestamp, seconds, lower word

Table 80. TIME_STAMP_H Register Definition

Addresses	Default	Access	Flash Backup
0x4E, 0x4F	0x0000	R	Yes

Table 81. TIME_STAMP_H Bit Descriptions

Bits	Description
[15:0]	Timestamp, seconds, upper word

DAY_REV, DAY AND REVISION

The DAY_REV (see Table 82 and Table 83) contains part of the factory programming date (day) and the revision of the firmware.

Table 82. DAY_REV Register Definition

Addresses	Default	Access	Flash Backup
0x52, 0x53	0x0000	R	N/A

Table 83. DAY_REV Bit Descriptions

Bits	Description
[15:12]	Day of the month, most significant digit
[11:8]	Day of the month, least significant digit
[7:4]	Firmware revision, most significant digit
[3:0]	Firmware revision, least significant digit

YEAR_MON, YEAR AND MONTH

The YEAR_MON (see Table 84 and Table 85) contains the factory programming date (month and year).

Table 84. YEAR_MON Register Definition

Addresses	Default	Access	Flash Backup
0x54, 0x55	Not applicable	R	N/A

Table 85. YEAR_MON Bit Descriptions

Bits	Description
[15:12]	Year, most significant digit
[11:8]	Year, least significant digit
[7:4]	Month of the year, most significant digit
[3:0]	Month of the year, least significant digit

PROD_ID, PRODUCT IDENTIFICATION

The PROD_ID (see Table 86 and Table 87) register contains the numerical portion of the model number.

Table 86. PROD_ID Register Definition

Addresses	Default	Access	Flash Backup
0x56, 0x57	0x03FD	R	N/A

Table 87. PROD_ID Bit Descriptions

Bits	Description
[15:0]	Binary representation of the numerical portion of the model number: 0x03FD = 1,021

SERIAL_NUM, SERIAL NUMBER

The SERIAL_NUM (see Table 88 and Table 89) contains the serial number of the unit, within a particular manufacturing lot.

Table 88. SERIAL_NUM Register Definition

Addresses	Default	Access	Flash Backup
0x58, 0x59	0x0000	R	N/A

Table 89. SERIAL_NUM Bit Descriptions

Bits	Description
[15:0]	Lot specific serial number

USER_SCRATCH

The USER_SCRATCH register allows end users to store a device number to identify the sensor. The register is readable and writable. Last written value is nonvolatile allowing for data recovery upon reset.

Table 90. USER_SCRATCH Register Definition

Addresses	Default	Access	Flash Backup
0x5A, 0x5B	N/A	R/W	Yes

Table 91. USER_SCRATCH Bit Descriptions

Bits	Description
[15:0]	Optional user ID

REC_FLASH_CNT, RECORD FLASH ENDURANCE

The REC_FLASH_CNT (see Table 92 and Table 93) provides a tool for tracking the endurance of the flash memory bank, which support the 10 record storage locations. The value in the REC_FLASH_CNT register increments after clearing the user record (GLOB_CMD) and each time the record storage fills up (tenth location contains event data)

Table 92. REC_FLASH_CNT Register Definition

Addresses	Default	Access	Flash Backup
0x5C, 0x5D	0x0000	R	N/A

Table 93. REC_FLASH_CNT Bit Descriptions

Bits	Description
[15:0]	Endurance counter for the record flash memory

MISC_CTRL, MISCELLANEOUS CONTROL

The MISC_CTRL register (see Table 94 and Table 95) enables the saving of MTC mode statistic values to memory, enable sensor self test, and enable SYNC pin to external control.

Table 94. MISC_CTRL Register Definition

Addresses	Default	Access	Flash Backup
0x64, 0x65	0x0000	W/R	No

Table 95. MISC_CTRL Bit Descriptions

Bits	Description
[15:13]	Unused.
12	Enable sensitivity to SYNC pin to start a capture. Must be enabled for external trigger for manual capture modes.
11	Unused.
10	Transfer statistics record from flash memory to SRAM. REC_PNTR must point to the appropriate time domain statistic record.
9	Transfers statistics from SRAM to flash record.
8	Clear time domain statistics.
[7:4]	Unused.
3	Set self test on.
2	Clear self test.
[1:0]	Unused.

REC_INFO1, RECORD INFORMATION

The REC_INFO1 register (see Table 96 and Table 97) contains the sample rate (SRx), window function, and FFT average settings associated with the spectral record in the user data buffer. The contents of this register are only relevant for results that come from MFFT and AFFT mode (see the REC_CTRL register in Table 47).

Table 96. REC_INFO1 Register Definition

Addresses	Default	Access	Flash Backup
0x66, 0x67	0x0000	R	Yes

Table 97. REC_INFO1 Bit Descriptions

Bits	Description
[15:14]	Sample rate option 00 = SR0 01 = SR1 10 = SR2 11 = SR3
[13:12]	Window setting 00 = rectangular 01 = Hanning 10 = flat top 11 = not applicable
[11:8]	Not used (don't care)
[7:0]	FFT averages; range = 1 to 2047

REC_INFO2, RECORD INFORMATION,

The REC_INFO2 (see Table 98 and Table 99) register contains the contents of the AVG_CNT register, which relate to the sample rate (SRx) in use for the spectral record in the user data buffer. The contents of this register are only relevant for results that come from MFFT and AFFT mode (see the REC_CTRL register in Table 47).

Table 98. REC_INFO2 Register Definition

Addresses	Default	Access	Flash Backup
0x68, 0x69	0x0000	R	Yes

Table 99. REC_INFO2 Bit Descriptions

Bits	Description
[15:4]	Not used (don't care)
[3:0]	AVG_CNT setting

REC_CNTR, RECORD COUNTER

The REC_CNTR (see Table 100 and Table 101) register contains the record counter, which contains the number of records currently in use.

Table 100. REC_CNTR Register Definition

Addresses	Default	Access	Flash Backup
0x6A, 0x6B	0x0000	R	N/A

Table 101. REC_CNTR Bit Descriptions

Bits	Description
[15:4]	Not used
[3:0]	Record counter range: 0 through 9

ALM_FREQ, SEVERE ALARM FREQUENCY

The ALM_FREQ register (see Table 102 and Table 103) contains the frequency bin that is associated with the value in the ALM_PEAK (see Table 77) register.

Table 102. ALM_FREQ Register Definition

Addresses	Default	Access	Flash Backup
0x70, 0x71	0x0000	R	Yes

Table 103. ALM_FREQ Bit Descriptions

Bits	Description
[15:12]	Not used
[11:0]	Alarm frequency for peak alarm level, FFT bin number; range = 0 to 2047

STAT_PNTR, STATISTIC RESULT POINTER

The STAT_PNTR register (see Table 104 and Table 105) controls which statistic loads to the statistic register (see Table 107). For example, set DIN = 0xF202 to write 0x02 to the lower byte of the STAT_PNTR, which causes the Kurtosis results to load to the statistic register.

Table 104. STAT_PNTR Register Definition

Addresses	Default	Access	Flash Backup
0x72, 0x73	0x0000	R/W	No

Table 105. STAT_PNTR Bit Descriptions

Bits	Description
[15:3]	Don't care
[2:0]	110 = skewness 101 = Kurtosis 100 = crest factor 011 = peak-to-peak 010 = peak 001 = standard deviation 000 = mean value

STATISTIC, STATISTIC RESULT

The statistic register (see Table 106 and Table 107) contains the statistical metric that represents the settings in the STAT_PNTR register (see Table 105). The data format for this register depends on the metric that it contains. When the lower byte of the STAT_PNTR register is equal to 0x00, 0x04, 0x05, or 0x06, the data format is the same as the OUT_BUF register (MTC mode). See Table 40 and Table 41 for a definition and some examples of this data format. When the lower byte of the STAT_PNTR register is equal to 0x01, 0x02, or 0x03, the statistic register uses the binary coded decimal (BCD) format shown in Table 107. Table 108 provides some numerical examples of this format.

Table 106. Statistic Register Definition

Addresses	Default	Access	Flash Backup
0x78, 0x79	0x0000	R	Yes

Table 107. Statistic Bit Descriptions for Crest Factor, Kurtosis and Skewness results

Bits	Description
[15:8]	Integer, offset binary format, 1 LSB = 1
[7:0]	Decimal, 1 LSB = 1/256 = 0.00390625

Table 108. Statistic Data Format Examples for Crest Factor, Kurtosis and Skewness results

Hex.	Integer	Decimal	Result
0x0000	0	0	0
0x0001	0	1/256 = 0.00390625	0.00390625
0x0002	0	2/256 = 0.0078125	0.0078125
0x000A	0	10/256 = 0.0390625	0.0390625
0x00FE	0	254/256 = 0.9921875	0.9921875
0x00FF	0	255/256 = 0.99609375	0.99609375
0x0100	1	0	1
0x016A	1	106/256 = 0.4140625	1.4140625
0x020A	2	10/256 = 0.0390625	2.0390625
0x069A	6	154/256 = 0.6015625	6.6015625
0x1AF2	26	242/256 = 0.9453125	26.9453125
0xFFFF	255	255/256 = 0.99609375	255.99609375

FUND_FREQ, FUNDAMENTAL FREQUENCY

The FUND_FREQ register (see Table 109 and Table 110) provides a simple way to configure the spectral alarms to monitor the fundamental vibration frequency on a platform, along with the subsequent harmonic frequencies. Table 111 provides the start and stop frequency settings for each alarm band, which automatically loads after writing to the upper byte of the FUND_FREQ register, the units are Hz. Default is disabled.

Table 109. FUND_FREQ Register Definition

Addresses	Default	Access	Flash Backup
0x7A, 0x7B	0x0000	R/W	Yes

Table 110. FUND_FREQ Bit Descriptions

Bits	Description
[15:0]	Fundamental frequency setting, f_f . Offset binary format, 1 LSB = 1 Hz. 0x0000 = no influence on alarm settings.

Table 111. Statistic Data Format Examples

Alarm Band	Start Frequency	Stop Frequency	Alarm 1 Level	Alarm 2 Level
1	$0.2 \times f_f$	$0.8 \times f_f$	$20\% \times 0.5 g$	0.5 g
2	$0.8 \times f_f$	$1.8 \times f_f$	$90\% \times 0.5 g$	0.5 g
3	$1.8 \times f_f$	$2.8 \times f_f$	$30\% \times 0.5 g$	0.5 g
4	$2.8 \times f_f$	$3.8 \times f_f$	$25\% \times 0.5 g$	0.5 g
5	$3.8 \times f_f$	$10.2 \times f_f$	$20\% \times 0.5 g$	0.5 g
6	$10.2 \times f_f$	f_{MAX}	$15\% \times 0.5 g$	0.5 g

FLASH_CNT_L, FLASH MEMORY ENDURANCE

FLASH_CNT_L (see Table 112 and Table 113) contains the lower 16 bits of a 32-bit counter. This counter tracks the total number of update cycles that the flash memory bank experiences.

Table 112. FLASH_CNT_L Register Definition

Addresses	Default	Access	Flash Backup
0x7C, 0x7D	Not applicable	R	N/A

Table 113. FLASH_CNT_L Bit Descriptions

Bits	Description
[15:0]	Flash update counter, lower word

FLASH_CNT_U, FLASH MEMORY ENDURANCE

The FLASH_CNT_U register (see Table 114 and Table 115) contains the upper 16 bits of a 32-bit counter. This counter tracks the total number of update cycles that the flash memory bank experiences.

Table 114. FLASH_CNT_U Register Definition

Addresses	Default	Access	Flash Backup
0x7E, 0x7F	0x0000	R	N/A

Table 115. FLASH_CNT_U Bit Descriptions

Bits	Description
[15:0]	Flash update counter, upper word

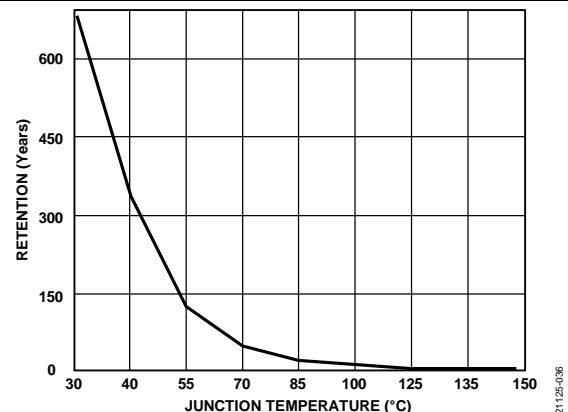

Figure 44. Flash/EE Memory Data Retention

FIR FILTER REGISTERS

The ADcmXL1021-1 signal chain includes a 32-tap, FIR filter. Register Page 1 through Register Page 6 provide user configuration access to the coefficients for six different FIR filter banks. The FILT_CTRL (see Table 66) register controls the enabling of the FIR filters and allows the selection of the FIR filter banks. Each FIR filter bank features factory default filter designs, and each filter bank provides write access to support application specific filter designs. To access one of the FIR filter banks, write the corresponding page number to the PAGE_ID register. For example, set DIN = 0x8003 to set PAGE_ID = 0x0003, which provides access to FIR Filter Bank C. See Table 19 for a complete listing of the FIR coefficient addresses and pages.

By default, the following filters are preconfigured in the respective filter bank registers:

- Filter Band A is a 32 tap, low-pass filter at 1 kHz.
- Filter Band B is a 32 tap, low-pass filter at 5 kHz.
- Filter Band C is a 32 tap, low-pass filter at 10 kHz.
- Filter Band D is a 32 tap, high-pass filter at 1 kHz.
- Filter Band E is a 32 tap, high-pass filter at 5 kHz.
- Filter Band F is a 32 tap, high-pass filter at 10 kHz.

FIR Filter Design Guidelines

User defined, 32 tap digital filtering can be programmed and stored. This filter uses 16-bit coefficients. Register Page 1 through Register Page 6 contain filter bank coefficients for Filter A to Filter F, respectively. Each of the 32 coefficients has a 16-bit register. User filters (as well as other register settings) can be stored internally in the ADcmXL1021-1.

The numerical format for each coefficient is a 16-bit, twos complement signed value. Signed values use the MSB to identify the sign of the value. If the MSB is 1, the values are negative. If the MSB is 0, the value is positive. The remaining 15 bits are the magnitude of the coefficient.

The 32 taps of the filter must sum to 0 to have unity gain. If values are summed as unsigned binary values, the summed value of 32,767 represents unity gain. By default, the FIR filters are designed to have a linear phase response up to 10 kHz.

APPLICATIONS INFORMATION

MECHANICAL INTERFACE

For the best performance, follow the guidelines described in this section when installing the ADcmXL1021-1 in a system.

Eliminate potential translational forces by aligning the module in a well defined orientation.

Use uniform mounting force on all four corners of the module. Use all four mounting holes and M2.5 screws at a torque of 5 inch-pounds.

Additional mechanical adhesives (cyanoacrylate adhesive and epoxies such as Dymax 652A gel adhesive) can be used to, in

some cases, improve mechanical coupling and frequency response. Application of these additional adhesives are mechanical design and processes dependent. Therefore, the application of these additional adhesives must be evaluated thoroughly during product development.

A minimum bend radius of the flex tail of 1 mm is allowed. At a lower bend radius, delamination or conductor failure may occur. The connector at the end of the flex tail is the DF12(3.0)-14DS-0.5V(86) from Hirose Electric Co. Ltd. The mating connector that must be used is the DF12(3.0)-14DP-0.5V(86) from Hirose Electric Co. Ltd.

OUTLINE DIMENSIONS

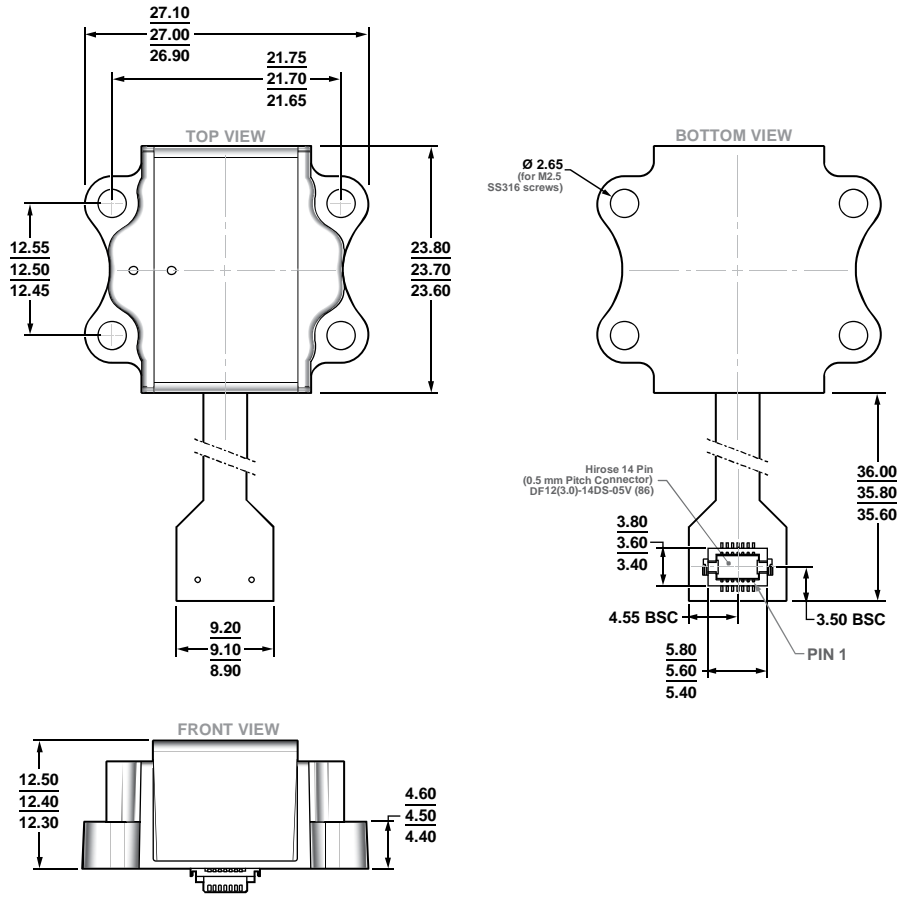

02-14-2019-B

Figure 45. 14-Lead Module with Integrated Flex Connector [MODULE] (ML-14-7)
Dimensions shown in millimeters

ORDERING GUIDE

Model ¹	Temperature Range	g Range	Package Description	Package Option
ADcmXL1021-1BMLZ	-40°C to +105°C	±50 g	14-Lead Module with Integrated Flex Connector [MODULE]	ML-14-7
EVAL-ADCM-1			ADcmXL1021-1 Evaluation Kit	
ADCMXL_BRKOUT/PCBZ			ADcmXL1021-1 Breakout Interface Board	

¹Z = RoHS Compliant Part.

X-ON Electronics

Largest Supplier of Electrical and Electronic Components

Click to view similar products for [Accelerometers](#) category:

Click to view products by [Analog Devices](#) manufacturer:

Other Similar products are found below :

[AD22372Z-RL7](#) [ADXL313WACPZ-RL](#) [805M1-0050-01](#) [MXC6655XA](#) [MMA7455LT](#) [805M1-0200-01](#) [810M1-0025X](#) [AIS328DQTR](#)
[832M1-0050](#) [805-0050](#) [AD22301](#) [BMA253](#) [ADXL354BEZ](#) [SCA620-EF8H1A-1](#) [MC3413](#) [MXC6244AU](#) [3038-0500](#) [ACH-01-04/10](#) [4692](#)
[ADXL372BCCZ-RL7](#) [735T](#) [787-500](#) [787AM8](#) [793-6](#) [793L](#) [997-M4](#) [HV101](#) [HV102](#) [HV200](#) [PC420AR-10](#) [PC420VP-50](#) [786A](#) [786A-IS](#)
[787A](#) [787A-IS](#) [HT786A](#) [HT787A](#) [PC420VP-10](#) [AD22293Z-RL7](#) [ADIS16003CCCZ](#) [ADIS16228CMLZ](#) [ADXL700WBRWZ-RL](#)
[ADXL1003BCPZ](#) [ADXL103CE-REEL](#) [ADXL203CE-REEL](#) [ADXL206HDZ](#) [ADXL213AE](#) [ADXL288WBRDZ-RL](#) [ADXL295WBRDZ-RL](#)
[ADXL312WACPZ](#)