



Single-Channel, 16-Bit, Current/Voltage Output DAC, Functional Safety Approved for Unipolar Current Output

Data Sheet

ADFS5758

FEATURES

Functional safety approved to SIL 2/SC3 for unipolar current output by TÜV Rheinland, File Number 968/FSF 2055.00/20

Current/voltage output available on a single terminal

Current output ranges: 0 mA to 20 mA, 4 mA to 20 mA, 0 mA to 24 mA, ± 20 mA, ± 24 mA, -1 mA to $+22$ mA

Voltage output ranges (with 20% overrange): 0 V to 5 V, 0 V to 10 V, ± 5 V, and ± 10 V

Advanced on-chip diagnostics

12-bit ADC functioning as an independent monitoring function that can validate the output and accuracy.

On-chip reference

DPC for thermal management

User-programmable offset and gain

Robust architecture, including output fault protection

EMC test standards

IEC 61000-4-6 conducted immunity (10 V, Class A)

IEC 61000-4-3 radiated immunity (20 V/m, Class A)

IEC 61000-4-2 ESD (± 6 kV contact, Class B)

IEC 61000-4-4 electrical fast transient (EFT) (± 4 kV, Class B)

IEC 61000-4-5 surge (± 4 kV, Class B)

CISRP 11 radiated emissions (Class B)

32-lead, 5 mm \times 5 mm LFCSP

-40°C to $+105^{\circ}\text{C}$ temperature range

APPLICATIONS

Process control

Actuator control

Channel isolated analog outputs

Programmable logic controller (PLC) and distributed control system (DCS) applications

HART network connectivity

GENERAL DESCRIPTION

The ADFS5758 is a single-channel, 16-bit, current/voltage output DAC. The device is functional safety approved for unipolar current output and is a fully compliant item with a systematic capability of SC3, which can be used in safety-related applications up to SIL 2, according to IEC 61508. This arrangement allows a single ADFS5758 to be used to achieve SIL 2 for a nonredundant

configuration. The safe state for the ADFS5758 is open circuit/high impedance.

The ADFS5758 is a single-channel, voltage and current output digital-to-analog converter (DAC) that operates with a power supply range from -33 V minimum on AV_{SS} to $+33$ V maximum on AV_{DD1} with a maximum operating voltage between the two rails of 60 V. On-chip dynamic power control (DPC) minimizes package power dissipation, which is achieved by regulating the supply voltage (V_{DPC+}) to the VI_{OUT} output driver circuitry from 4.95 V to 27 V using a buck dc-to-dc converter, optimized for minimum on-chip power dissipation. The C_{HART} pin enables a HART[®] signal to be coupled onto the current output.

The device uses a versatile 4-wire serial peripheral interface (SPI) that operates at clock rates of up to 50 MHz and is compatible with standard SPI, QSPI[™], MICROWIRE[™], DSP, and microcontroller interface standards. The interface also features an optional SPI cyclic redundancy check (CRC) and a windowed watchdog timer. The ADFS5758 offers improved diagnostic features from its predecessors, such as an integrated independent 12-bit diagnostic analog-to-digital converter (ADC) that can be used to digitize both internal and external nodes.

PRODUCT HIGHLIGHTS

1. Functional safety approved to SIL 2/SC3 by TÜV Rheinland.
2. Range of advanced diagnostic features, including an integrated ADC for high reliability.
3. DPC using an integrated buck dc-to-dc converter for thermal management. When used with the [ADP1031](#), the ADFS5758 enables eight channel to channel isolated outputs at <2 W dissipated power.
4. Programmable power control (PPC) mode to enable faster settling time (15 μs typical).
5. Highly robust with output protection from miswire events (± 38 V).

COMPANION PRODUCTS

Product Family: [AD5755-1](#), [AD5422](#), [AD5758](#), [AD5753](#), [AD5423](#)

HART Modem: [AD5700](#), [AD5700-1](#)

External References: [ADR431](#), [ADR3425](#), [ADR4525](#)

Digital Isolators: [ADuM142D](#), [ADuM141D](#)

Power: [ADP1031](#), [LT8300](#), [ADP2360](#), [ADM6339](#)



Rev. 0

[Document Feedback](#)

Information furnished by Analog Devices is believed to be accurate and reliable. However, no responsibility is assumed by Analog Devices for its use, nor for any infringements of patents or other rights of third parties that may result from its use. Specifications subject to change without notice. No license is granted by implication or otherwise under any patent or patent rights of Analog Devices. Trademarks and registered trademarks are the property of their respective owners.

One Technology Way, P.O. Box 9106, Norwood, MA 02062-9106, U.S.A.
Tel: 781.329.4700 ©2020 Analog Devices, Inc. All rights reserved.
[Technical Support](#) [www.analog.com](#)

TABLE OF CONTENTS

Features	1	Fault Protection	36
Applications	1	Current Output	36
Product Highlights	1	HART Connectivity	37
Companion Products.....	1	Digital Slew Rate Control.....	37
Revision History	2	ADFS5758 Address Pins	37
Functional Block Diagram	3	SPI Interface and Diagnostics	38
Specifications	4	Windowed Watchdog Timer (WDT)	39
AC Performance Characteristics.....	10	User Digital Offset and Gain Control	39
Timing Characteristics	11	DAC Output Update and Data Integrity Diagnostics	40
Absolute Maximum Ratings	14	Lockable User Configuration Space	41
Thermal Resistance	14	Use of Key Codes	42
ESD Caution.....	14	Software Reset.....	42
Pin Configuration and Function Descriptions	15	Calibration Memory CRC.....	42
Typical Performance Characteristics.....	17	Background CRC Check	42
Current Output.....	17	Internal Oscillator Diagnostics	42
Voltage Output	22	V _{LDO} External Capacitor Detection.....	43
DC-to-DC Block.....	26	Sticky Diagnostic Results Bits	43
Reference	27	Background Supply and Temperature Monitoring	43
General.....	28	Output Fault.....	43
Terminology.....	29	ADC Monitoring.....	44
Theory of Operation	31	Register Map	50
Functional Safety Operation.....	31	Writing to Registers.....	50
DAC Architecture	31	Reading from Registers	51
Serial Interface	32	Programming Sequence to Enable the Output Correctly	54
Power-On State of the ADFS5758	32	Register Details.....	56
Power Supply Considerations	32	Applications Information	73
Device Features and Diagnostics.....	34	Outline Dimensions.....	75
Power Dissipation Control	34	Ordering Guide	75
Interdie 3-Wire Interface	35		
Voltage Output	36		

REVISION HISTORY

6/2020—Revision 0: Initial Version

FUNCTIONAL BLOCK DIAGRAM

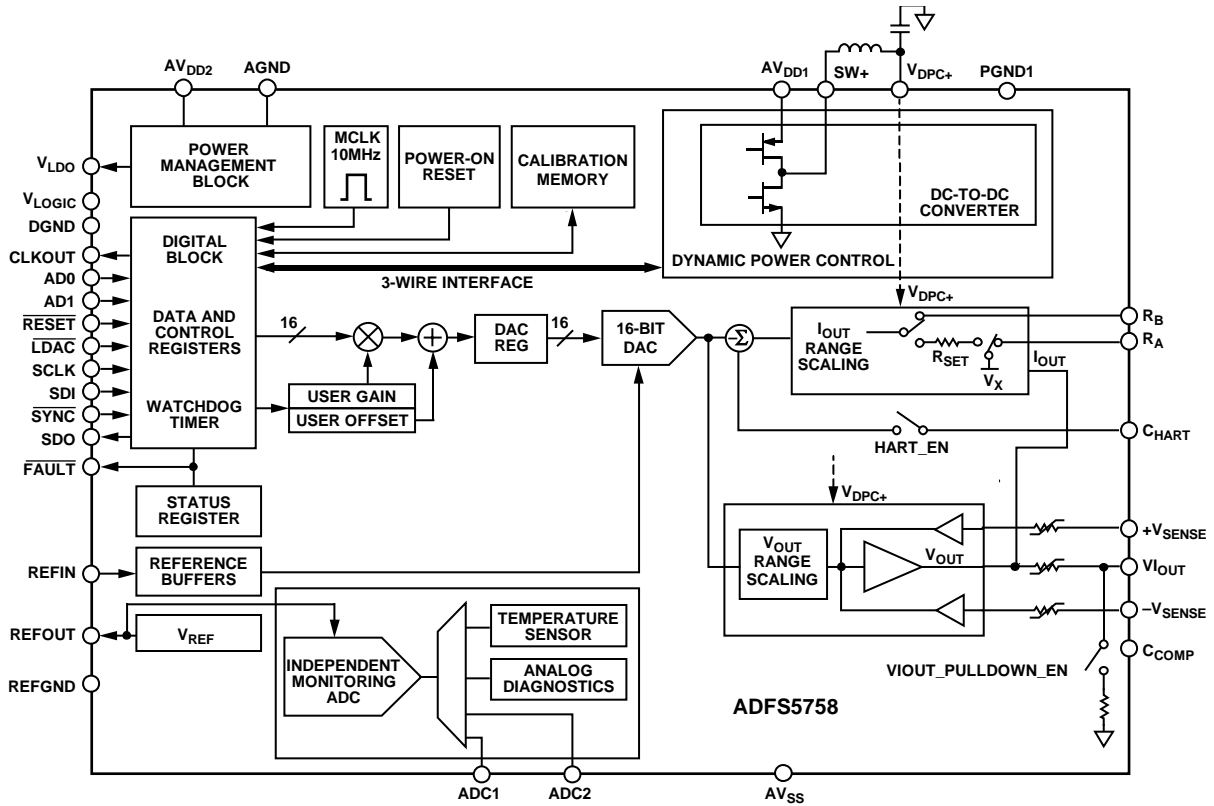

Figure 1.

21790-001

SPECIFICATIONS

$AV_{DD1} = V_{DPC+} = 15\text{ V}$; dc-to-dc converter disabled; $AV_{DD2} = 5\text{ V}$; $AV_{SS} = -15\text{ V}$; $V_{LOGIC} = 1.71\text{ V to }5.5\text{ V}$; $AGND = DGND = REFGND = PGND1 = 0\text{ V}$; $REFIN = 2.5\text{ V}$ external; voltage output: load resistance (R_{LOAD}) = $1\text{ k}\Omega$, load capacitance (C_L) = 220 pF ; current output: $R_L = 300\ \Omega$; all specifications at $T_A = -40^\circ\text{C to }+105^\circ\text{C}$, $T_J < 125^\circ\text{C}$, unless otherwise noted.

Table 1.

Parameter	Min	Typ	Max	Unit	Test Conditions/Comments
CURRENT OUTPUT					
Output Current Ranges (I_{OUT})	0		24	mA	Functional safety approved range
	0		20	mA	Functional safety approved range
	4		20	mA	Functional safety approved range
	-20		+20	mA	
	-24		+24	mA	
	-1		+22	mA	
Resolution	16			Bits	
CURRENT OUTPUT ACCURACY (EXTERNAL CURRENT SETTING RESISTOR (R_{SET})) ¹					Assumes ideal $13.7\text{ k}\Omega$ resistor
Unipolar Ranges					4 mA to 20 mA, 0 mA to 20 mA, and 0 mA to 24 mA ranges
Total Unadjusted Error (TUE)	-0.06		+0.06	% FSR	
	-0.012		+0.012	% FSR	$T_A = 25^\circ\text{C}$
TUE Long-Term Stability		125		ppm FSR	Drift after 1000 hours, $T_J = 135^\circ\text{C}$
Output Drift		3	7	ppm FSR/ $^\circ\text{C}$	
Integral Nonlinearity (INL)	-0.006		+0.006	% FSR	
Differential Nonlinearity (DNL)	-1		+1	LSB	Guaranteed monotonic
Zero-Scale Error	-0.03	± 0.002	+0.03	% FSR	
Zero-Scale Temperature Coefficient (TC) ³		± 0.5		ppm FSR/ $^\circ\text{C}$	
Offset Error	-0.03	± 0.001	+0.03	% FSR	
Offset Error TC ³		± 0.7		ppm FSR/ $^\circ\text{C}$	
Gain Error	-0.05	± 0.001	+0.05	% FSR	
Gain Error TC ³		± 3		ppm FSR/ $^\circ\text{C}$	
Full-Scale Error	-0.05	± 0.001	+0.05	% FSR	
Full-Scale Error TC ³		± 3		ppm FSR/ $^\circ\text{C}$	
Bipolar Ranges					$\pm 20\text{ mA}$, $\pm 24\text{ mA}$, and $-1\text{ mA to }+22\text{ mA}$ ranges
TUE	-0.08		+0.08	% FSR	
	-0.014		+0.014	% FSR	$T_A = 25^\circ\text{C}$
TUE Long-Term Stability ²		125		ppm FSR	Drift after 1000 hours, $T_J = 135^\circ\text{C}$
Output Drift		12	15.5	ppm FSR/ $^\circ\text{C}$	
INL	-0.01		+0.01	% FSR	
DNL	-1		+1	LSB	Guaranteed monotonic
Zero-Scale Error	-0.04	± 0.002	+0.04	% FSR	
Zero-Scale TC ³		± 0.9		ppm FSR/ $^\circ\text{C}$	
Bipolar Zero Error	-0.02	± 0.002	+0.02	% FSR	
Bipolar Zero Error TC ³		± 0.4		ppm FSR/ $^\circ\text{C}$	
Offset Error	-0.06	± 0.002	+0.06	% FSR	
Offset Error TC ³		± 0.9		ppm FSR/ $^\circ\text{C}$	
Gain Error	-0.08	± 0.002	+0.08	% FSR	
Gain Error TC ³		± 4		ppm FSR/ $^\circ\text{C}$	
Full-Scale Error	-0.08	± 0.002	+0.08	% FSR	
Full-Scale Error TC ³		± 3		ppm FSR/ $^\circ\text{C}$	

Parameter	Min	Typ	Max	Unit	Test Conditions/Comments
CURRENT OUTPUT ACCURACY (INTERNAL R_{SET})					
Unipolar Ranges					
TUE	-0.12		+0.12	% FSR	4 mA to 20 mA, 0 mA to 20 mA, and 0 mA to 24 mA ranges
TUE Long-Term Stability ²		380		ppm FSR	Drift after 1000 hours, $T_J = 135^\circ\text{C}$
Output Drift		3	6	ppm FSR/ $^\circ\text{C}$	Output drift
INL	-0.01		+0.01	% FSR	
DNL	-1		+1	LSB	Guaranteed monotonic
Zero-Scale Error	-0.04	± 0.001	+0.04	% FSR	
Zero-Scale TC ³		± 0.5		ppm FSR/ $^\circ\text{C}$	
Offset Error	-0.04	± 0.001	+0.04	% FSR	
Offset Error TC ³		± 1		ppm FSR/ $^\circ\text{C}$	
Gain Error	-0.1	± 0.003	+0.1	% FSR	
Gain Error TC ³		± 3		ppm FSR/ $^\circ\text{C}$	
Full-Scale Error	-0.12	± 0.003	+0.12	% FSR	
Full-Scale Error TC ³		± 3		ppm FSR/ $^\circ\text{C}$	
Bipolar Ranges					
TUE	-0.12		+0.12	% FSR	± 20 mA, ± 24 mA, and -1 mA to $+22$ mA ranges
TUE Long-Term Stability ²		380		ppm FSR	Drift after 1000 hours, $T_J = 135^\circ\text{C}$
Output Drift		3	6	ppm FSR/ $^\circ\text{C}$	Output drift
INL	-0.02		+0.02	% FSR	
DNL	-1		+1	LSB	Guaranteed monotonic
Zero-Scale Error	-0.06	± 0.001	+0.06	% FSR	
Zero-Scale TC ³		± 2		ppm FSR/ $^\circ\text{C}$	
Bipolar Zero Error	-0.02	± 0.002	+0.02	% FSR	
Bipolar Zero Error TC ³		± 0.3		ppm FSR/ $^\circ\text{C}$	
Offset Error	-0.06	± 0.001	+0.06	% FSR	
Offset Error TC ³		± 1		ppm FSR/ $^\circ\text{C}$	
Gain Error	-0.12	± 0.003	+0.12	% FSR	
Gain Error TC ³		± 3		ppm FSR/ $^\circ\text{C}$	
Full-Scale Error	-0.12	± 0.005	+0.12	% FSR	
Full-Scale Error TC ³		± 3		ppm FSR/ $^\circ\text{C}$	
CURRENT OUTPUT CHARACTERISTICS					
Headroom	2.3			V	Minimum voltage required between V_{IOUT} and V_{DPC+} supply
Footroom	2.35/0			V	Minimum voltage required between V_{IOUT} and AV_{SS} supply and unipolar ranges do not require any footroom
Resistive Load ³			1000	Ω	The dc-to-dc converter is characterized with a maximum load of 1 k Ω , chosen such that headroom/footroom compliance is not exceeded
Output Impedance		100		M Ω	Midscale output
DC Power Supply Rejection Ratio (PSRR)		0.1		$\mu\text{A/V}$	

Parameter	Min	Typ	Max	Unit	Test Conditions/Comments
VOLTAGE OUTPUT					
Output Voltage Ranges (V_{OUT})	0		5	V	Trimmed V_{OUT} ranges
	0		10	V	
	-5		+5	V	
	-10		+10	V	
Output Voltage Overranges	0		6	V	Untrimmed overranges
	0		12	V	
	-6		+6	V	
	-12		+12	V	
Output Voltage Offset Ranges	-0.3		+5.7	V	Untrimmed negatively offset ranges
	-0.4		+11.6	V	
Resolution	16			Bits	
VOLTAGE OUTPUT ACCURACY					
Loaded and unloaded, accuracy specifications refer to trimmed V_{OUT} ranges only, unless otherwise noted					
TUE	-0.05		+0.05	% FSR	$T_A = 25^\circ\text{C}$
	-0.01		+0.01	% FSR	
TUE Long-Term Stability ²		15		ppm FSR	Drift after 1000 hours, $T_J = 135^\circ\text{C}$
Output Drift		0.35	1.35	ppm FSR/ $^\circ\text{C}$	Output drift
Relative Accuracy (INL)	-0.006		+0.006	% FSR	All ranges
DNL	-1		+1	LSB	Guaranteed monotonic, all ranges
Zero-Scale Error	-0.02	± 0.002	+0.02	% FSR	
Zero-Scale Error TC^3		± 0.3		ppm FSR/ $^\circ\text{C}$	
Bipolar Zero Error	-0.015	+0.001	+0.015	% FSR	$\pm 5\text{ V}, \pm 10\text{ V}$
Bipolar Zero Error TC^3		± 0.3		ppm FSR/ $^\circ\text{C}$	$\pm 5\text{ V}, \pm 10\text{ V}$
Offset Error	-0.02	± 0.002	+0.02	% FSR	
Offset Error TC^3		± 0.3		ppm FSR/ $^\circ\text{C}$	
Gain Error	-0.02	± 0.001	+0.02	% FSR	
Gain Error TC^3		± 0.3		ppm FSR/ $^\circ\text{C}$	
Full-Scale Error	-0.02	± 0.001	+0.02	% FSR	
Full-Scale Error TC^3		± 0.3		ppm FSR/ $^\circ\text{C}$	
VOLTAGE OUTPUT CHARACTERISTICS					
Headroom	2			V	Minimum voltage required between V_{IOUT} and V_{DPC+} supply
Footroom	2			V	Minimum voltage required between V_{IOUT} and AV_{SS} supply
Short-Circuit Current		16		mA	
Load ³	1			k Ω	For specified performance
Capacitive Load Stability ³			10	nF	External compensation capacitor of 220 pF connected
			2	μF	
DC Output Impedance		7		m Ω	
DC PSRR		10		$\mu\text{V}/\text{V}$	
$V_{OUT}/-V_{SENSE}$ Common-Mode Rejection Ratio (CMRR)		10		$\mu\text{V}/\text{V}$	Error in V_{OUT} voltage due to changes in $-V_{SENSE}$ voltage

Parameter	Min	Typ	Max	Unit	Test Conditions/Comments
REFERENCE INPUT/OUTPUT					
Reference Input					
Reference Input Voltage ⁴		2.5		V	For specified performance
DC Input Impedance	55	120		MΩ	
Reference Output					
Output Voltage	2.495	2.5	2.505	V	T _A = 25°C (including drift after 1000 hours at T _J = 135°C)
Reference TC ³	-10		+10	ppm/°C	
Output Noise (0.1 Hz to 10 Hz) ³		7		μV p-p	
Noise Spectral Density ³		80		nV/√Hz	At 10 kHz
Capacitive Load ³			1000	nF	
Load Current		3		mA	
Short-Circuit Current		5		mA	
Line Regulation		1		ppm/V	
Load Regulation		80		ppm/mA	
Thermal Hysteresis ³		150		ppm	
V_{LDO} OUTPUT					
Output Voltage		3.3		V	
Output Voltage TC ³		25		ppm/°C	
Output Voltage Accuracy	-2		+2	%	
Externally Available Current			30	mA	
Short-Circuit Current		55		mA	
Load Regulation		0.8		mV/mA	
Capacitive Load		0.1		μF	Recommended operation
DC-TO-DC					
Start-Up Time		1.25		ms	
Switch					
Peak Current Limit ³	150		400	mA	User programmable in 50 mA steps via the DCDC_CONFIG2 register
Oscillator					
Oscillator Frequency (f _{sw})		500		kHz	
Minimum Duty Cycle		5		%	
Current Output DPC Mode					
V _{DPC+} Voltage Range	4.95		27	V	Current output dynamic power control mode Assuming sufficient supply margin between AV _{DD1} and V _{DPC+} ; see the Power Dissipation Control section for further details; maximum operating range of V _{DPC+} to AV _{SS} = 50 V
V _{DPC+} Headroom		2.3	2.5	V	Typical voltage headroom between V _{IOUT} and V _{DPC+} ; only applicable when dc-to-dc converter is in regulation (that is, load is sufficiently high)
Current Output PPC Mode					PPC mode
V _{DPC+} Voltage Range	5		25.677	V	Assuming sufficient supply margin between AV _{DD1} and V _{DPC+} ; see the Power Dissipation Control section for further details; maximum operating range of V _{DPC+} to AV _{SS} = 50 V
V _{DPC+} Voltage Accuracy	-500		+500	mV	Only applicable when dc-to-dc is operating in regulation (that is, load is sufficiently high)
Voltage Output DPC Mode					
V _{DPC+} Voltage Range	5	15	25	V	Voltage output dynamic power control mode 5 V = -V _{SENSE(MIN)} + 15 V; 25 V = -V _{SENSE(MAX)} + 15 V; assuming sufficient supply margin between AV _{DD1} and V _{DPC+} ; see the Power Dissipation Control section for further details; maximum operating range of V _{DPC+} to AV _{SS} = 50 V
V _{DPC+} Voltage Accuracy	-500		+500	mV	Only applicable when dc-to-dc is operating in regulation (that is, load sufficiently high)

Parameter	Min	Typ	Max	Unit	Test Conditions/Comments
VI _{OUT} LINE PROTECTOR					
On Resistance (R _{ON})		12		Ω	T _A = 25°C
Overshoot Response Time (t _{RESPONSE})		250		ns	
Overshoot Leakage Current		±100		μA	Line protector fault detect block sinks current for a positive fault and sources current for a negative fault
ADC					
Resolution		12		Bits	
Input Voltage Range					
ADC1 Pin	0		0.5	V	ADC_IP_SELECT = 10000
	-0.5		+0.5	V	ADC_IP_SELECT = 10010, AV _{SS} must be ≤ -1 V
	0		1.25	V	ADC_IP_SELECT = 01111
	0		2.5	V	ADC_IP_SELECT = 10001
ADC2 Pin	-15		+15	V	
Total Error					
ADC1 Pin	-0.25		+0.25	% FSR	2.5 V input range
	-0.3		+0.3	% FSR	1.25 V input range
	-0.5		+0.5	% FSR	0 V to 0.5 V and ±0.5 V input ranges
ADC2 Pin	-0.5		+0.5	% FSR	
All other ADC Inputs		±0.3		% FSR	Table 19 lists all ADC input nodes
Conversion Time ³		100		μs	
DIGITAL INPUTS					
Input Voltage					
3 V ≤ V _{LOGIC} ≤ 5.5 V					
High, V _{IH}	0.7 × V _{LOGIC}			V	
Low, V _{IL}			0.3 × V _{LOGIC}	V	
1.71 V ≤ V _{LOGIC} < 3 V					
High, V _{IH}	0.8 × V _{LOGIC}			V	
Low, V _{IL}			0.2 × V _{LOGIC}	V	
Input Current	-1.5		+1.5	μA	Per pin, internal pull-down on SCLK, SDI, $\overline{\text{RESET}}$, and LDAC; internal pull-up on SYNC
Pin Capacitance ³		2.4		pF	Per pin
DIGITAL OUTPUTS					
SDO					
Output Voltage					
Low, V _{OL}			0.4	V	Sinking 200 μA
High, V _{OH}	V _{LOGIC} - 0.2			V	Sourcing 200 μA
High Impedance Leakage Current	-1		+1	μA	
High Impedance Output Capacitance ³		2.2		pF	
FAULT					
Output Voltage					
Low, V _{OL}			0.4	V	10 kΩ pull-up resistor to V _{LOGIC}
		0.6		V	At 2.5 mA
High, V _{OH}	V _{LOGIC} - 0.05			V	10 kΩ pull-up resistor to V _{LOGIC}

Parameter	Min	Typ	Max	Unit	Test Conditions/Comments
POWER REQUIREMENTS					
Supply Voltages					
AV_{DD1} ⁵	7		33	V	Maximum operating range of $ AV_{DD1}$ to $AV_{SS} = 60$ V
AV_{DD2}	5		33	V	Maximum operating range of $ AV_{DD2}$ to $AV_{SS} = 50$ V
AV_{SS} ⁵	-33		0	V	Maximum operating range of $ AV_{DD1}$ to $AV_{SS} = 60$ V; for bipolar output ranges, V_{OUT}/I_{OUT} headroom must be obeyed when calculating AV_{SS} maximum; for unipolar current output ranges, AV_{SS} maximum = 0 V; for unipolar voltage output ranges, AV_{SS} maximum = -2 V
V_{LOGIC}	1.71		5.5	V	
Supply Quiescent Currents ⁵					Quiescent current, assuming no load current
AV_{DD1} Current (I_{DD1})		0.05	0.11	mA	Voltage output mode, dc-to-dc converter enabled but not active
		0.05	0.11	mA	Current output mode, dc-to-dc converter enabled but not active
AV_{DD2} Current (I_{DD2})		3.3	3.6	mA	Voltage output mode, dc-to-dc converter enabled but not active
		2.9	3.1	mA	Current output mode, dc-to-dc converter enabled but not active
AV_{SS} Current (I_{SS})	-1.4	-1.1		mA	Voltage output mode
	-3.15	-2.4		mA	Bipolar current output mode
	-0.26	-0.23		mA	Unipolar current output mode
V_{LOGIC} Current (I_{LOGIC})			0.01	mA	$V_{IH} = V_{LOGIC}$, $V_{IL} = DGND$
$VDPC+$ Current (I_{DPC+})		1.0	1.3	mA	Voltage output mode
		0.8	1	mA	Unipolar current output mode
		2.4	3.15	mA	Bipolar current output mode
Power Dissipation					Power dissipation assuming an ideal power supply and excluding external load power dissipation, current output DPC mode, 0 mA to 20 mA range
		103		mW	$AV_{DD1} = 24$ V, $AV_{DD2} = 5$ V, $AV_{SS} = -15$ V, $R_{LOAD} = 1$ k Ω , $I_{OUT} = 20$ mA
		145		mW	$AV_{DD1} = 24$ V, $AV_{DD2} = 5$ V, $AV_{SS} = -15$ V, $R_{LOAD} = 0$ Ω , $I_{OUT} = 20$ mA
		155		mW	$AV_{DD1} = AV_{DD2} = 24$ V, $AV_{SS} = -15$ V, $R_{LOAD} = 1$ k Ω , $I_{OUT} = 20$ mA
		200		mW	$AV_{DD1} = AV_{DD2} = 24$ V, $AV_{SS} = -15$ V, $R_{LOAD} = 0$ Ω , $I_{OUT} = 20$ mA

¹ See the Current Output Mode section for more information about the internal and external R_{SET} resistors.

² The long-term stability specification is noncumulative. The drift in subsequent 1000 hour periods is significantly lower than in the first 1000 hour period.

³ Guaranteed by design and characterization; not production tested.

⁴ The ADFS5758 is factory calibrated with an external 2.5 V reference connected to REFIN.

⁵ Production tested to AV_{DD1} maximum = 30 V and AV_{SS} minimum = -30 V.

AC PERFORMANCE CHARACTERISTICS

$AV_{DD1} = V_{DPC+} = 15\text{ V}$; dc-to-dc converter disabled; $AV_{DD2} = 5\text{ V}$; $AV_{SS} = -15\text{ V}$; $V_{LOGIC} = 1.71\text{ V to }5.5\text{ V}$; $AGND = DGND = REFGND = PGND1 = 0\text{ V}$; $REFIN = 2.5\text{ V}$ external; voltage output: $R_L = 1\text{ k}\Omega$, $C_L = 220\text{ pF}$; current output: $R_L = 300\ \Omega$; all specifications at $T_A = -40^\circ\text{C to }+105^\circ\text{C}$, $T_J < 125^\circ\text{C}$, unless otherwise noted.

Table 2.

Parameter	Min	Typ	Max	Unit	Test Conditions/Comments
DYNAMIC PERFORMANCE¹					
Current Output					
Output Current Settling Time		15		μs	To 0.1% FSR (0 mA to 24 mA), dc-to-dc converter disabled
		15		μs	PPC mode, dc-to-dc converter enabled, dc-to-dc current limit = 150 mA
		200		μs	DPC mode, dc-to-dc converter enabled; external inductor and capacitor components as described in Table 10, dc-to-dc current limit = 150 mA.
Output Noise (0.1 Hz to 10 Hz Bandwidth)		0.2		LSB p-p	16-bit LSB, 0 mA to 24 mA range
Output Noise Spectral Density		0.8		nA/ $\sqrt{\text{Hz}}$	Measured at 10 kHz, midscale output, 0 mA to 24 mA range
AC PSRR		80		dB	200 mV, 50 Hz/60 Hz sine wave superimposed on power supply voltage
Voltage Output					
Output Voltage Settling Time					Output voltage settling time specifications also apply for dc-to-dc converter enabled
		6	20	μs	5 V step to $\pm 0.03\%$ FSR, 0 V to 5 V range
		12	20	μs	10 V step to $\pm 0.03\%$ FSR, 0 V to 10 V range
			15	μs	100 mV step to 1 LSB (16-bit LSB), 0 V to 10 V range
Slew Rate		3		V/ μs	0 V to 10 V range, digital slew rate control disabled
Power-On Glitch Energy		25		nV-sec	
Digital-to-Analog Glitch Energy		5		nV-sec	
Glitch Impulse Peak Amplitude		25		mV	
Digital Feedthrough		2		nV-sec	
Output Noise (0.1 Hz to 10 Hz Bandwidth)		0.2		LSB p-p	16-bit LSB, 0 V to 10 V range
Output Noise Spectral Density		185		nV/ $\sqrt{\text{Hz}}$	Measured at 10 kHz, midscale output, 0 V to 10 V range
AC PSRR		70		dB	200 mV, 50 Hz/60 Hz sine wave superimposed on power supply voltage

¹ Guaranteed by design and characterization; not production tested.

TIMING CHARACTERISTICS

$AV_{DD1} = V_{DPC+} = 15\text{ V}$; dc-to-dc converter disabled; $AV_{DD2} = 5\text{ V}$; $AV_{SS} = -15\text{ V}$; $V_{LOGIC} = 1.71\text{ V}$ to 5.5 V ; $AGND = DGND = REFGND = PGND1 = 0\text{ V}$; $REFIN = 2.5\text{ V}$ external; voltage output: $R_L = 1\text{ k}\Omega$, $C_L = 220\text{ pF}$; current output: $R_L = 300\ \Omega$; all specifications at $T_A = -40^\circ\text{C}$ to $+105^\circ\text{C}$, $T_J < 125^\circ\text{C}$, unless otherwise noted.

Table 3.

Parameter ^{1,2,3}	$1.71\text{ V} \leq V_{LOGIC} < 3\text{ V}$	$3\text{ V} \leq V_{LOGIC} \leq 5.5\text{ V}$	Unit	Description
t ₁	33	20	ns min	SCLK cycle time, write operation
	120	66	ns min	SCLK cycle time, read operation
t ₂	16	10	ns min	SCLK high time, write operation
	60	33	ns min	SCLK high time, read operation
t ₃	16	10	ns min	SCLK low time, write operation
	60	33	ns min	SCLK low time, read operation
t ₄	10	10	ns min	\overline{SYNC} falling edge to SCLK falling edge setup time, write operation
	33	33	ns min	\overline{SYNC} falling edge to SCLK falling edge setup time, read operation
t ₅	10	10	ns min	24 th /32 nd SCLK falling edge to \overline{SYNC} rising edge
t ₆	500	500	ns min	\overline{SYNC} high time (all register writes outside of those listed in this table)
	1.5	1.5	μs min	\overline{SYNC} high time (DAC_INPUT register write)
	500	500	μs min	\overline{SYNC} high time (DAC_CONFIG register write, where the range bits, Bits[3:0], change; see the Calibration Memory CRC section)
t ₇	5	5	ns min	Data setup time
t ₈	6	6	ns min	Data hold time
t ₉	750	750	ns min	\overline{LDAC} falling edge to \overline{SYNC} rising edge
t ₁₀	1.5	1.5	μs min	\overline{SYNC} rising edge to \overline{LDAC} falling edge
t ₁₁	250	250	ns min	\overline{LDAC} pulse width low
t ₁₂	600	600	ns max	\overline{LDAC} falling edge to DAC output response time, digital slew rate control disabled
	2	2	μs max	\overline{LDAC} falling edge to DAC output response time, digital slew rate control enabled
t ₁₃	See the AC Performance Characteristics section		μs max	DAC output settling time
t ₁₄	1.5	1.5	μs max	\overline{SYNC} rising edge to DAC output response time ($\overline{LDAC} = 0$)
t ₁₅	5	5	μs min	\overline{RESET} pulse width
t ₁₆	40	28	ns max	SCLK rising edge to SDO valid
t ₁₇	100	100	μs min	\overline{RESET} rising edge to first SCLK falling edge after \overline{SYNC} falling edge (t ₁₇ does not appear in the timing diagrams)

¹ Guaranteed by design and characterization. Not production tested.

² All input signals are specified with $t_R = t_F = 5\text{ ns}$ (10% to 90% of V_{LOGIC}) and timed from a voltage level of 1.2 V. t_R is rise time. t_F is fall time.

³ See Figure 2 to Figure 5.

Timing Diagrams

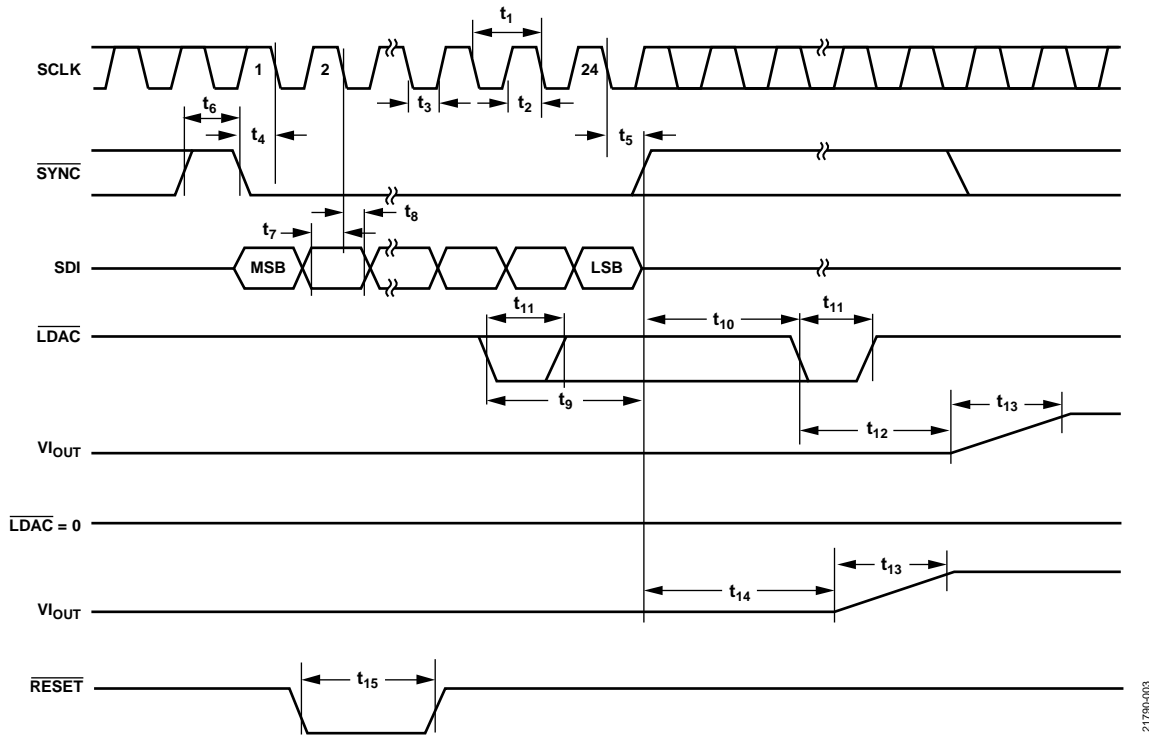

Figure 2. Serial Interface Timing Diagram

21790-003

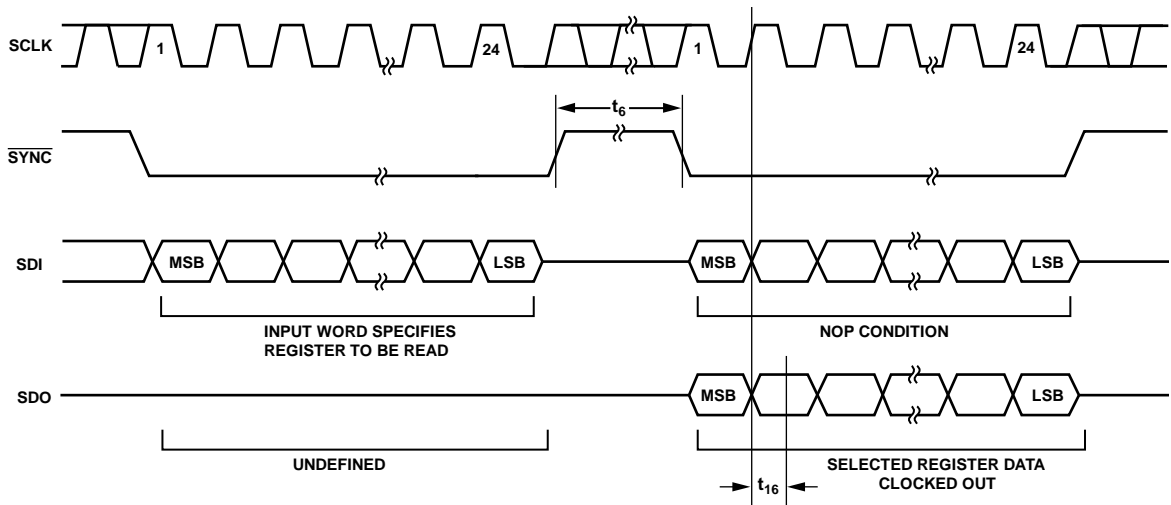
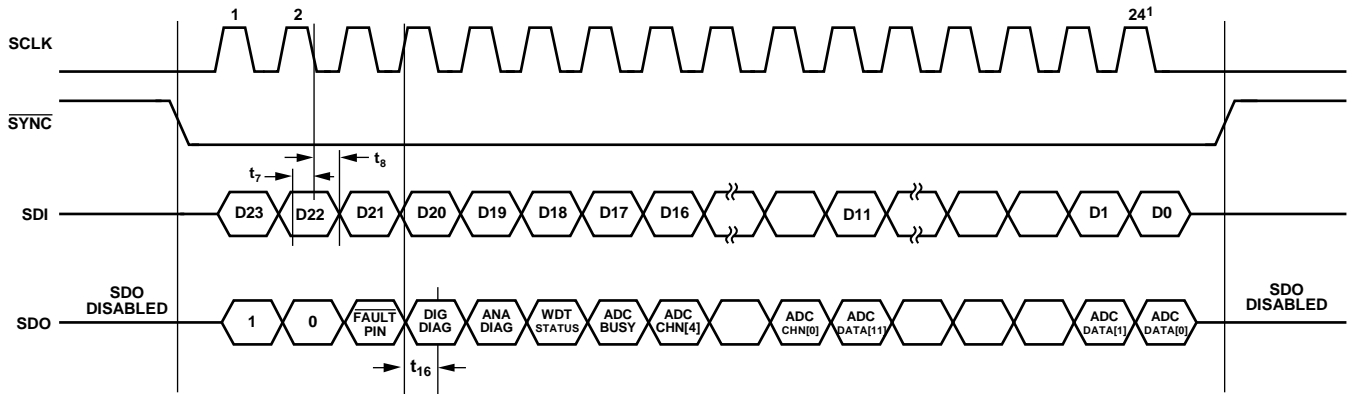

Figure 3. Readback Timing Diagram

21790-004



¹IF ANY EXTRA SCLK FALLING EDGES ARE RECEIVED AFTER THE 24TH (OR 32ND, IF CRC IS ENABLED) SCLK, BEFORE $\overline{\text{SYNC}}$ RETURNS HIGH, SDO CLOCKS OUT 0.

Figure 4. Autostatus Readback

21790-005

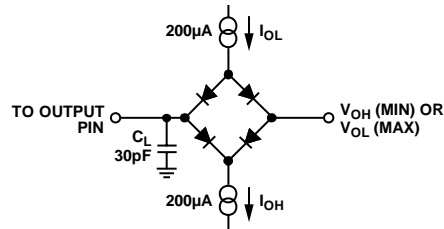

Figure 5. Load Circuit for SDO Timing Diagram

21790-006

ABSOLUTE MAXIMUM RATINGS

$T_A = 25^\circ\text{C}$, unless otherwise noted. Transient currents of up to ± 200 mA do not cause silicon controlled rectifier (SCR) latch-up.

Table 4.

Parameter	Rating
AV_{DD1} to AGND, DGND	-0.3 V to $+44$ V
AV_{SS} to AGND, DGND	$+0.3$ V to -35 V
AV_{DD1} to AV_{SS}	-0.3 V to $+66$ V
AV_{DD2} , V_{DPC+} to AGND, DGND	-0.3 V to $+35$ V
AV_{DD2} , V_{DPC+} to AV_{SS}	-0.3 V to $+55$ V
V_{LOGIC} to DGND	-0.3 V to $+6$ V
Digital Inputs to DGND (SCLK, SDI, SYNC, AD0, AD1, RESET, LDAC)	-0.3 V to $V_{LOGIC} + 0.3$ V or $+6$ V (whichever is less)
Digital Outputs to DGND (FAULT, SDO, CLKOUT)	-0.3 V to $V_{LOGIC} + 0.3$ V or $+6$ V (whichever is less)
REFIN, REFOUT, V_{LDO} , C_{HART} to AGND	-0.3 V to $AV_{DD2} + 0.3$ V or $+6$ V (whichever is less)
R_A to AGND	-0.3 V to $+4.5$ V
R_B to AGND	-0.3 V to $+4.5$ V
V_{IOUT} to AGND	± 38 V
$+V_{SENSE}$ to AGND	± 38 V
$-V_{SENSE}$ to AGND	± 38 V
ADC1, ADC2 to AGND	± 38 V
C_{COMP} to AGND	$AV_{SS} - 0.3$ V to $V_{DPC+} + 0.3$ V
SW+ to AGND	-0.3 V to $AV_{DD1} + 0.3$ V or $+33$ V (whichever is less)
AGND, DGND to REFGND	-0.3 V to $+0.3$ V
AGND, DGND to PGND1	-0.3 V to $+0.3$ V
Industrial Operating Temperature Range (T_A) ¹	-40°C to $+105^\circ\text{C}$
Storage Temperature Range	-65°C to $+150^\circ\text{C}$
Junction Temperature (T_J maximum)	125°C
Power Dissipation	$(T_J \text{ maximum} - T_A)/\theta_{JA}$
Lead Temperature	JEDEC industry standard
Soldering	J-STD-020
Electrostatic Discharge (ESD)	
Human Body Model ²	± 3 kV
Field Induced Charged Device Model ³	± 1 kV

¹ Power dissipated on chip must be derated to keep the junction temperature below 125°C .

² As per ANSI/ESDA/JEDEC JS-001, all pins.

³ As per ANSI/ESDA/JEDEC JS-002, all pins.

Stresses at or above those listed under Absolute Maximum Ratings may cause permanent damage to the product. This is a stress rating only; functional operation of the product at these or any other conditions above those indicated in the operational section of this specification is not implied. Operation beyond the maximum operating conditions for extended periods may affect product reliability.

THERMAL RESISTANCE

Thermal performance is directly linked to printed circuit board (PCB) design and operating environment. Close attention to PCB thermal design is required. θ_{JA} is the junction to ambient thermal resistance, and θ_{JC} is the junction to case thermal resistance.

Table 5. Thermal Resistance

Package Type	θ_{JA} ¹	θ_{JC}	Unit
CP-32-30	46	18	$^\circ\text{C}/\text{W}$

¹ Test Condition 1: thermal impedance simulated values are based on a JEDEC 2S2P thermal test board with thermal vias. See JEDEC JESD51.

ESD CAUTION



ESD (electrostatic discharge) sensitive device.

Charged devices and circuit boards can discharge without detection. Although this product features patented or proprietary protection circuitry, damage may occur on devices subjected to high energy ESD. Therefore, proper ESD precautions should be taken to avoid performance degradation or loss of functionality.

PIN CONFIGURATION AND FUNCTION DESCRIPTIONS

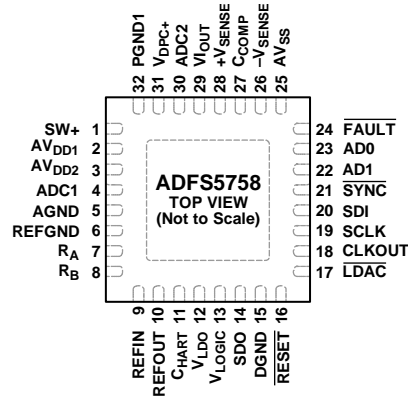

NOTES

1. EXPOSED PAD. CONNECT THE EXPOSED PAD TO THE POTENTIAL OF THE AV_{SS} PIN, OR, ALTERNATIVELY, IT CAN BE LEFT ELECTRICALLY UNCONNECTED. IT IS RECOMMENDED THAT THE PAD BE THERMALLY CONNECTED TO A COPPER PLANE FOR ENHANCED THERMAL PERFORMANCE.

21790-007

Figure 6. Pin Configuration

Table 6. Pin Function Descriptions

Pin No.	Mnemonic	Description
1	SW+	Switching Output for the DC-to-DC Circuitry. To use the dc-to-dc feature of the device, connect as shown in Figure 77.
2	AV _{DD1}	Positive Analog Supply. The voltage range is from 7 V to 33 V.
3	AV _{DD2}	Positive Low Voltage Analog Supply. The voltage range is from 5 V to 33 V.
4	ADC1	Multiplexed ADC External Input 1 (Input Range of 0 V to 0.5 V, 0 V to 2.5 V, or ± 0.5 V).
5	AGND	Ground Reference Point for the Analog Circuitry. This pin must be connected to 0 V.
6	REFGND	Ground Reference Point for Internal Reference. This pin must be connected to 0 V.
7	R _A	External Current Setting Resistor. An external, precision, low drift 13.7 k Ω current setting resistor can be connected between R _A and R _B to improve the current output temperature drift performance. It is recommended that the external resistor be placed as close as possible to the ADFS5758.
8	R _B	External Current Setting Resistor. An external, precision, low drift 13.7 k Ω current setting resistor can be connected between R _A and R _B to improve the current output temperature drift performance. It is recommended that the external resistor be placed as close as possible to the ADFS5758.
9	REFIN	External 2.5 V Reference Voltage Input.
10	REFOUT	Internal 2.5 V Reference Voltage Output. REFOUT must be connected to REFIN to use the internal reference. A capacitor between REFOUT and REFGND is not recommended.
11	C _{HART}	HART Input Connection. The HART signal must be ac-coupled to this pin. If HART is not being used, leave this pin unconnected. This pin is disconnected from the HART summing node by default and can be connected via the HART_EN bit in the GP_CONFIG1 register.
12	V _{LDO}	3.3 V Low Dropout (LDO) Output Voltage. V _{LDO} must be decoupled to AGND with a 0.1 μ F capacitor.
13	V _{LOGIC}	Digital Supply. The voltage range is from 1.71 V to 5.5 V. V _{LOGIC} must be decoupled to DGND with a 0.1 μ F capacitor.
14	SDO	Serial Data Output. This pin clocks data from the serial register in readback mode. The maximum SCLK speed for readback mode is 15 MHz (depending on the V _{LOGIC} voltage). See the Timing Characteristics section.
15	DGND	Digital Ground.
16	RESET	Hardware Reset. Active low input. Do not write an SPI command within 100 μ s of issuing a reset (using the hardware RESET pin or via software).
17	LDAC	Load DAC. Active low input. This pin updates the DAC_OUTPUT register and, consequently, the DAC output. Do not assert LDAC within 500 ns before the rising edge of SYNC or 1.5 μ s after the rising edge of SYNC (see the Timing Characteristics section for the timing specifications).
18	CLKOUT	Optional Clock Output Signal (Disabled by Default). This pin is a divided down version of the internal 10 MHz oscillator (MCLK) and is configured in the GP_CONFIG1 register.
19	SCLK	Serial Clock Input. Data is clocked into the input shift register on the falling edge of SCLK. In write mode, this pin operates at clock speeds of up to 50 MHz (depending on the V _{LOGIC} voltage). In read mode, the maximum SCLK speed is 15 MHz (depending on the V _{LOGIC} voltage). See the Timing Characteristics section for the timing specifications.
20	SDI	Serial Data Input. Data must be valid on the falling edge of SCLK.

Pin No.	Mnemonic	Description
21	$\overline{\text{SYNC}}$	Frame Synchronization Signal for the Serial Interface. Active low input. While $\overline{\text{SYNC}}$ is low, data is transferred in on the falling edge of SCLK.
22	AD1	Address Decode 1 for the ADFS5758 on the Board.
23	AD0	Address Decode 0 for the ADFS5758 on the Board.
24	$\overline{\text{FAULT}}$	Fault Pin. Active low, open-drain output. This pin is high impedance when no faults are detected and is asserted low when certain faults are detected, for example, an open circuit in current mode, a short circuit in voltage mode, a CRC error, or an overtemperature error (see the Output Fault section). This pin must be connected to V_{LOGIC} with a 10 k Ω pull-up resistor.
25	AV_{SS}	Negative Analog Supply. The voltage range is from 0 V to -33 V. If using the device solely for unipolar current output purposes, AV_{SS} can be 0 V. For a unipolar voltage output, AV_{SS} (maximum) is -2.5 V. When using bipolar output ranges, $V_{\text{OUT}}/I_{\text{OUT}}$ headroom must be obeyed when calculating the AV_{SS} maximum. For example, for a ± 10 V output, the AV_{SS} maximum is -12.5 V. See the AV_{SS} Considerations section for an important note on power supply sequencing.
26	$-V_{\text{SENSE}}$	Sense Connection for the Negative Voltage Output Load Connection for V_{OUT} Mode. This pin must stay within ± 10 V of AGND for specified operation. It is recommended to connect a series 1 k Ω resistor to this pin. If remote sensing is not being used, short this pin to AGND via the 1 k Ω resistor.
27	C_{COMP}	Optional Compensation Capacitor Connection for the Voltage Output Buffer. Connecting a 220 pF capacitor between this pin and the V_{IOUT} pin allows the voltage output to drive up to 2 μF . The addition of this capacitor reduces the bandwidth of the output amplifier, increasing the settling time.
28	$+V_{\text{SENSE}}$	Sense Connection for the Positive Voltage Output Load Connection for Voltage Output Mode. It is recommended to connect a series 1 k Ω resistor to this pin. If remote sensing is not being used, short this pin to V_{IOUT} via the 1 k Ω resistor.
29	V_{IOUT}	Voltage/Current Output Pin. V_{IOUT} is a shared pin, providing either a buffered output voltage or current.
30	ADC2	Multiplexed ADC External Input 2 (Input Range of ± 15 V).
31	$V_{\text{DPC+}}$	Positive Supply for Current and Voltage Output Stage. To use the dc-to-dc feature of the device, connect as shown in Figure 77.
32	PGND1 EPAD	Power Ground. Exposed Pad. Connect the exposed pad to the potential of the AV_{SS} pin, or, alternatively, it can be left electrically unconnected. It is recommended that the pad be thermally connected to a copper plane for enhanced thermal performance.

TYPICAL PERFORMANCE CHARACTERISTICS

CURRENT OUTPUT

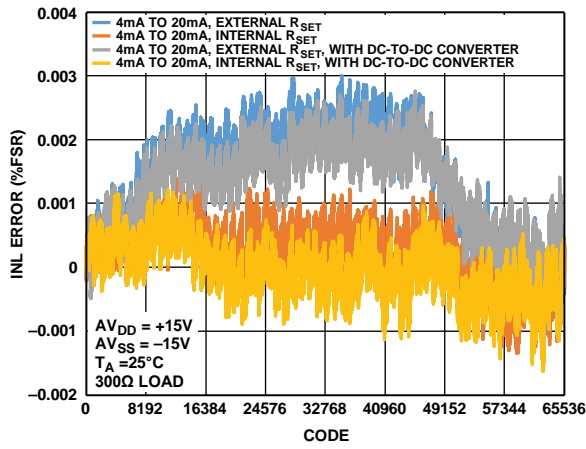

Figure 7. INL Error vs. DAC Code

21790-236

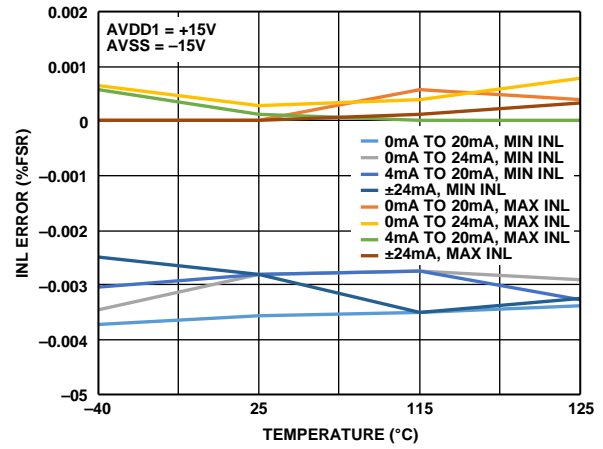

Figure 10. INL Error vs. Temperature, Internal RSET

21790-434

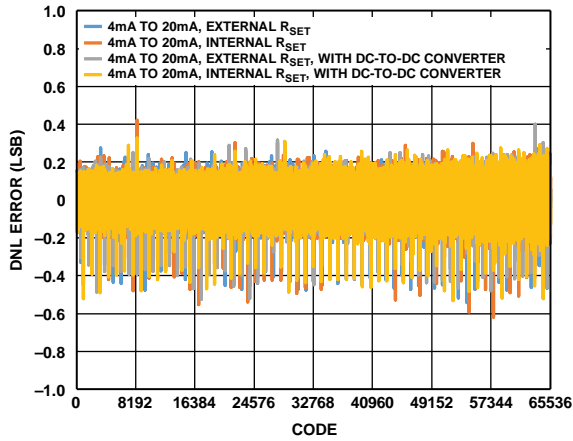

Figure 8. DNL Error vs. DAC Code

21790-237

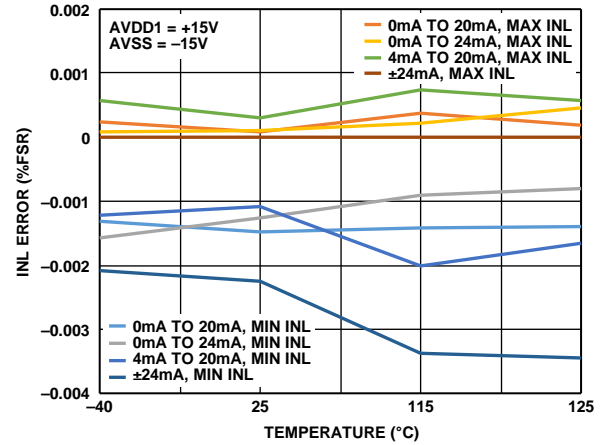

Figure 11. INL Error vs. Temperature, External RSET

21790-435

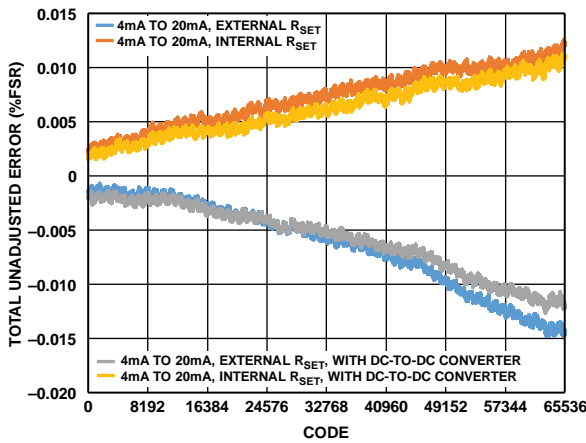

Figure 9. Total Unadjusted Error vs. DAC Code

21790-238

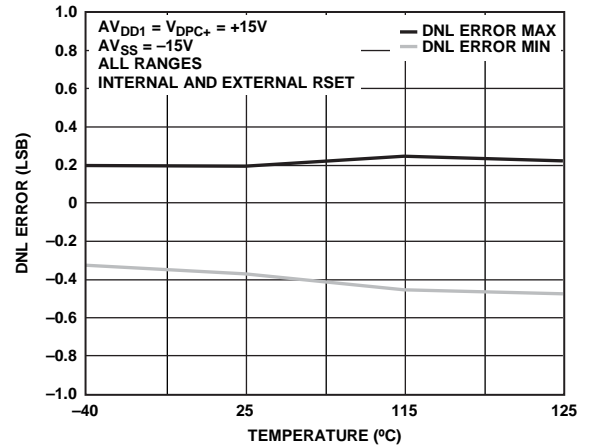

Figure 12. DNL vs. Temperature

21790-436

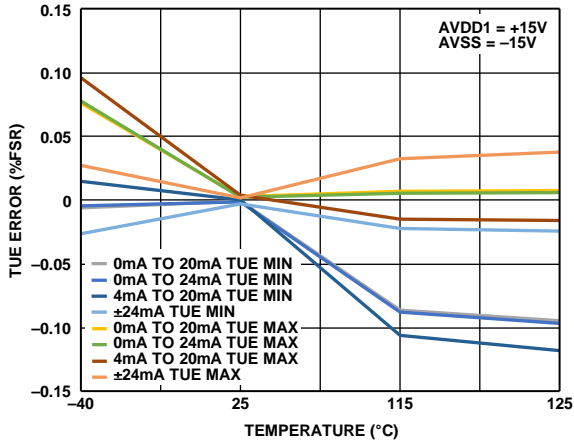

Figure 13. Total Unadjusted Error vs. Temperature, Internal RSET

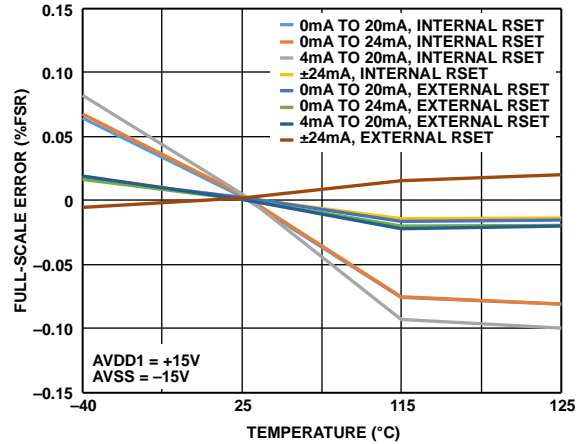

Figure 16. Full-Scale Error vs. Temperature

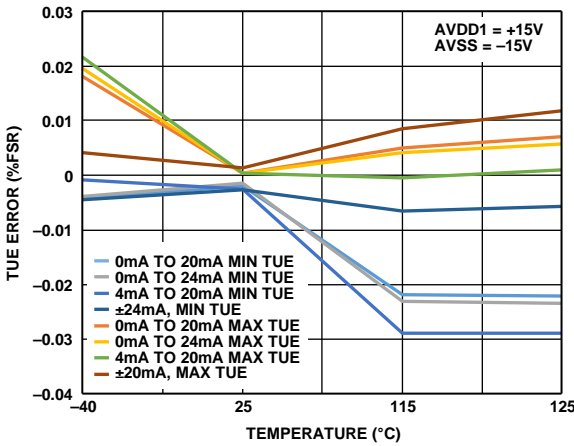

Figure 14. Total Unadjusted Error vs. Temperature, External RSET

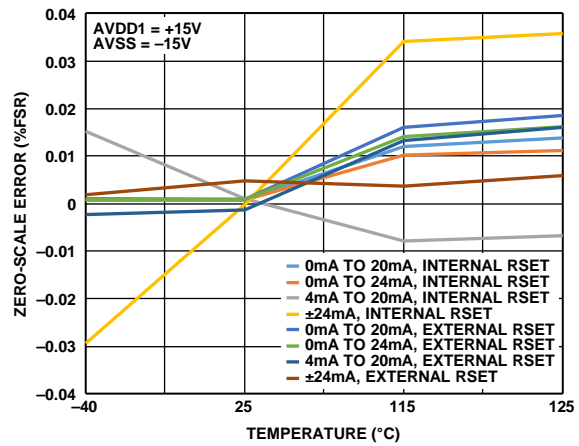

Figure 17. Zero-Scale Error vs. Temperature

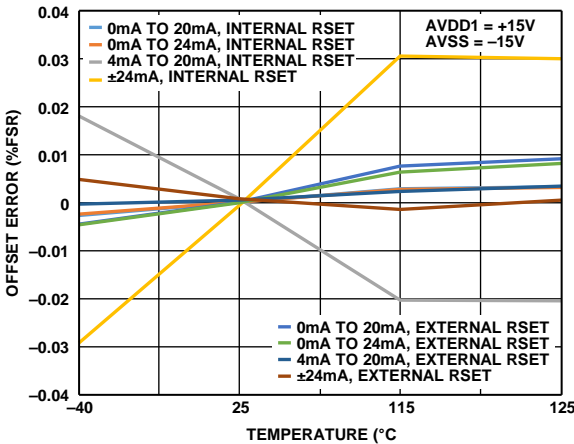

Figure 15. Offset Error vs. Temperature

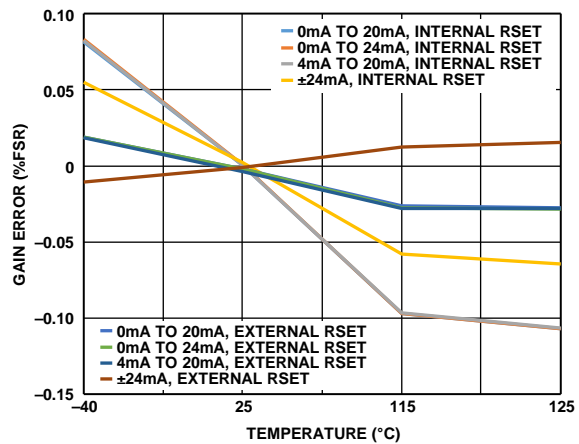

Figure 18. Gain Error vs. Temperature

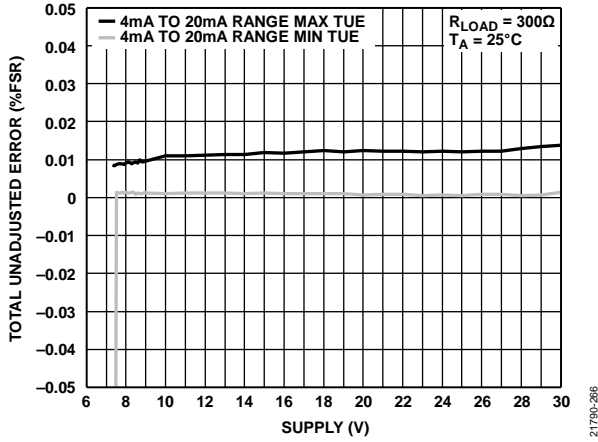

Figure 19. Total Unadjusted Error vs. $AV_{DD1}/|AV_{SS}|$ Supply, Internal R_{SET}

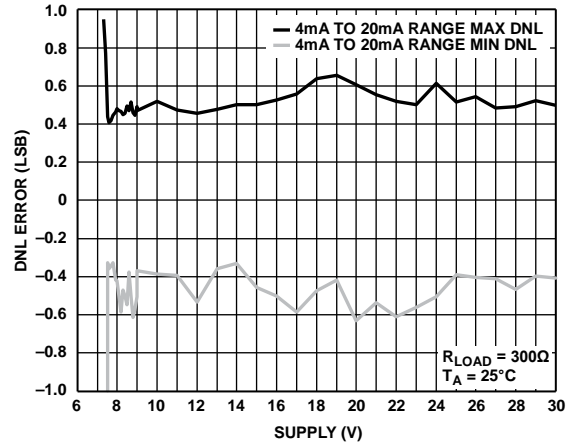

Figure 22. DNL Error vs. $AV_{DD1}/|AV_{SS}|$ Supply, External R_{SET}

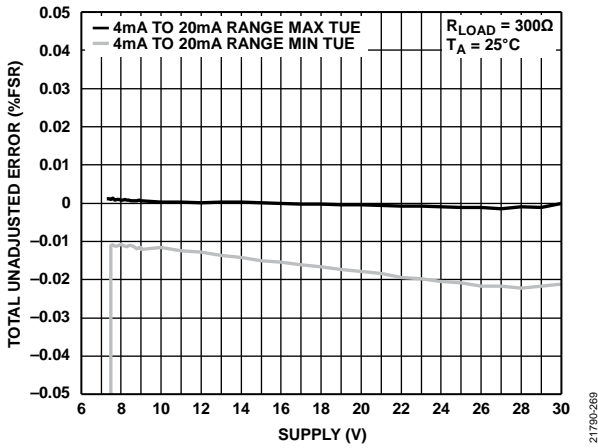

Figure 20. Total Unadjusted Error vs. $AV_{DD1}/|AV_{SS}|$ Supply, External R_{SET}

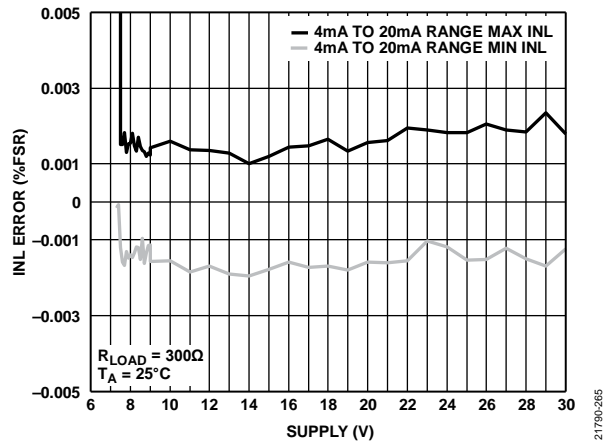

Figure 23. INL Error vs. $AV_{DD1}/|AV_{SS}|$ Supply, Internal R_{SET}

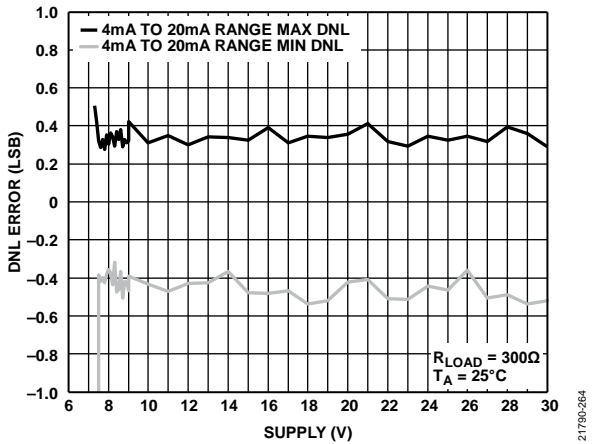

Figure 21. DNL Error vs. $AV_{DD1}/|AV_{SS}|$ Supply, Internal R_{SET}

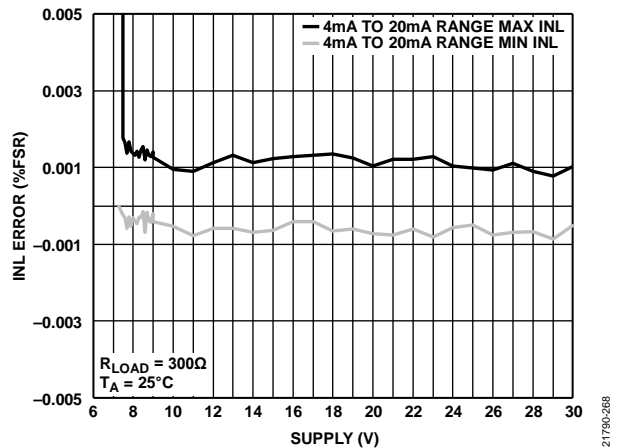

Figure 24. INL Error vs. $AV_{DD1}/|AV_{SS}|$ Supply, External R_{SET}

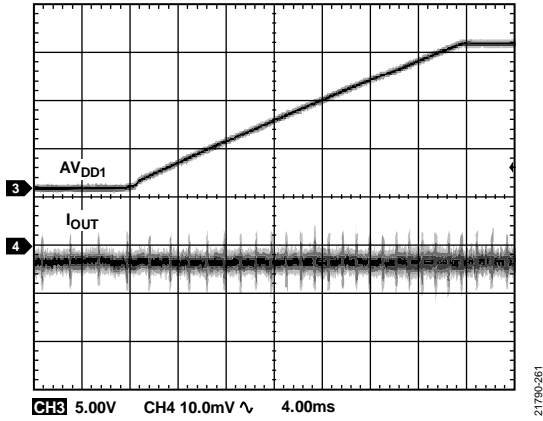

Figure 25. Output Current vs. Time on Power-Up

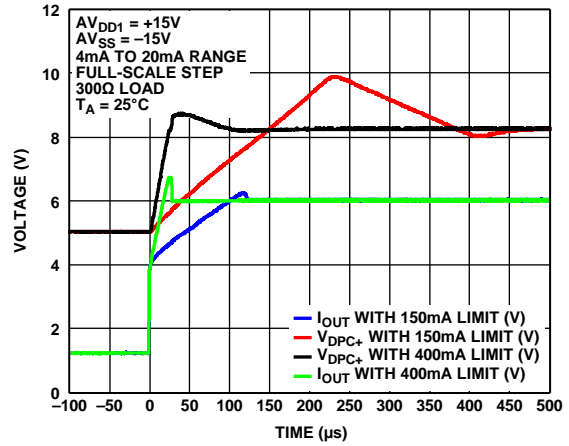

Figure 28. Output Current and V_{DPC+} Settling Time, 300 Ω Load

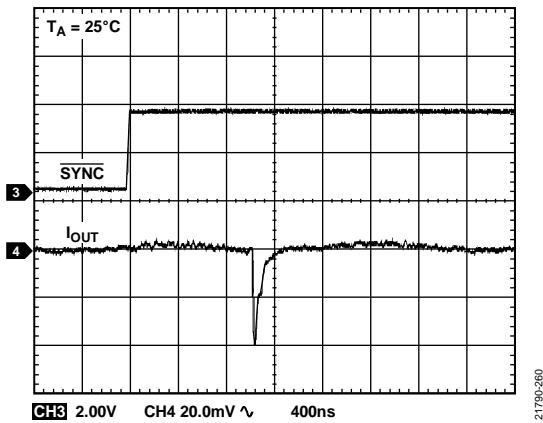

Figure 26. Output Current vs. Time on Output Enable

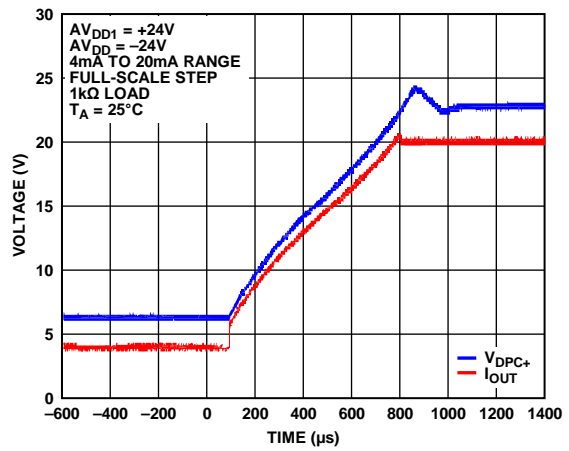

Figure 29. Output Current and V_{DPC+} Settling Time, 1 k Ω Load

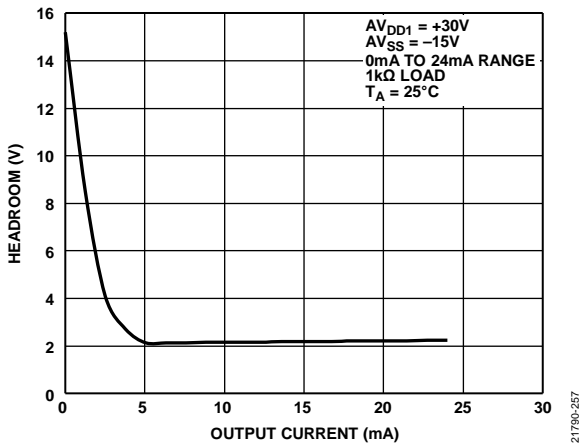

Figure 27. DC-to-DC Converter Headroom vs. Output Current

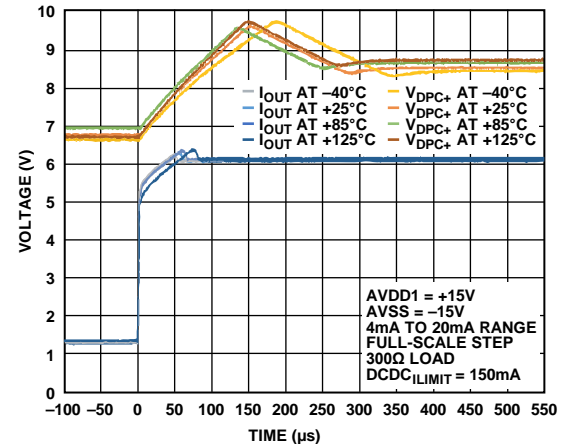

Figure 30. Output Current and V_{DPC+} Settling Time vs. Temperature

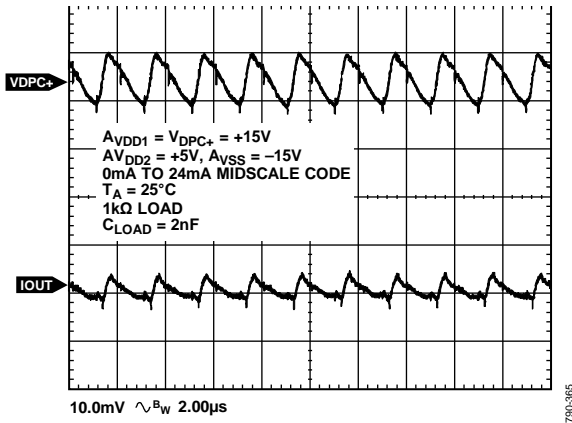

Figure 31. Output Current Ripple vs. Time with DC-to-DC Converter

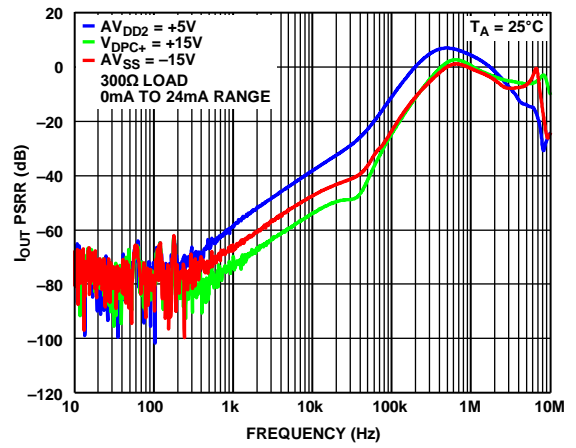

Figure 32. I_{OUT} PSRR vs. Frequency

VOLTAGE OUTPUT

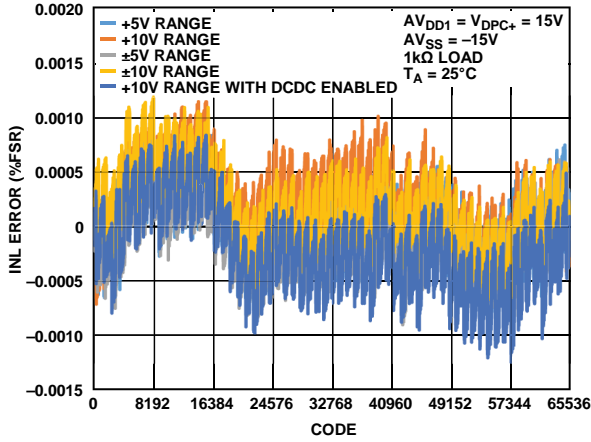

Figure 33. INL Error vs. DAC Code

21790-207

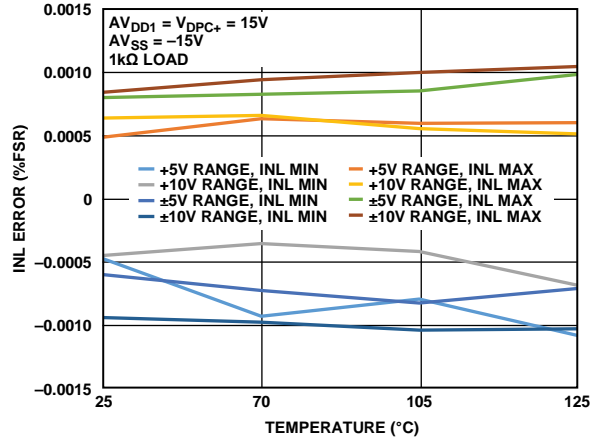

Figure 36. INL Error vs. Temperature

21790-210

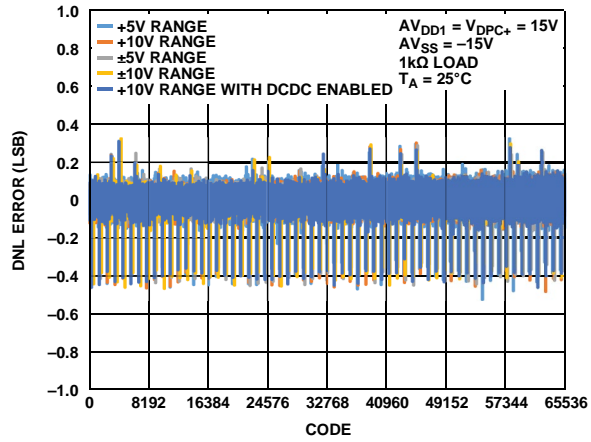

Figure 34. DNL Error vs. DAC Code

21790-208

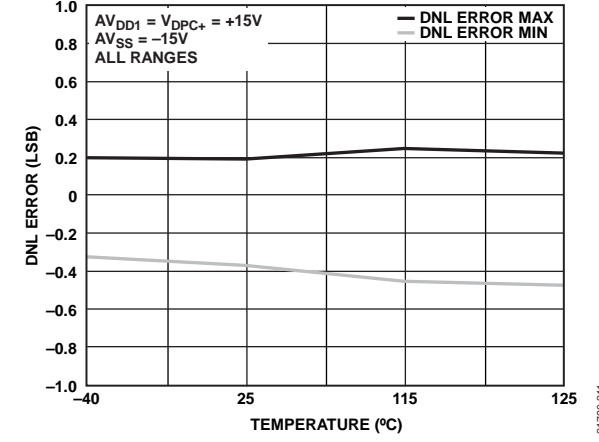

Figure 37. DNL Error vs. Temperature

21790-211

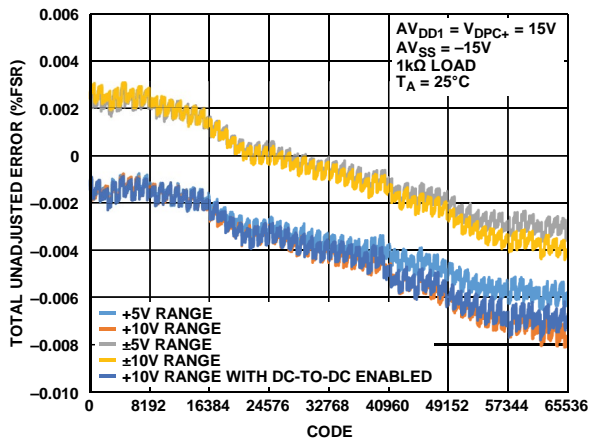

Figure 35. Total Unadjusted Error vs. DAC Code

21790-209

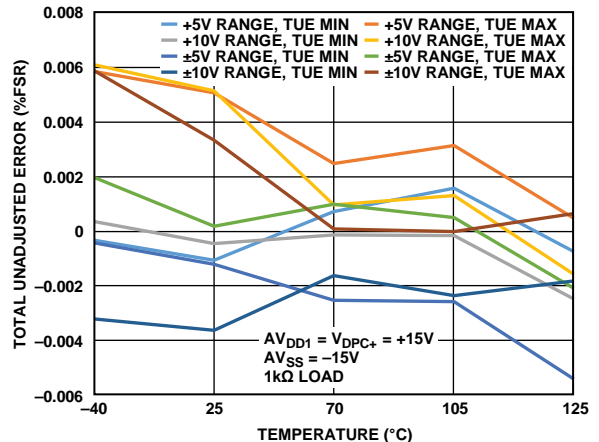

Figure 38. Total Unadjusted Error vs. Temperature

21790-212

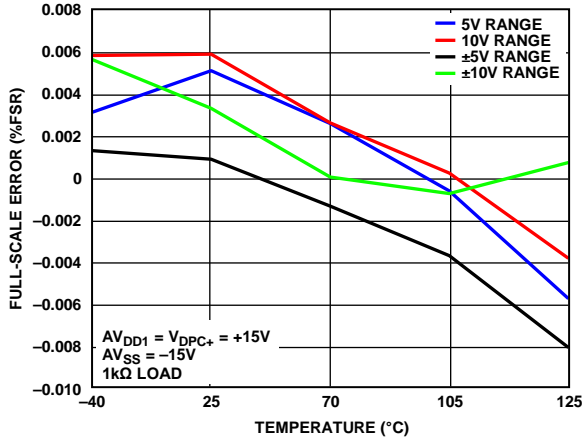

Figure 39. Full-Scale Error vs. Temperature

21790-214

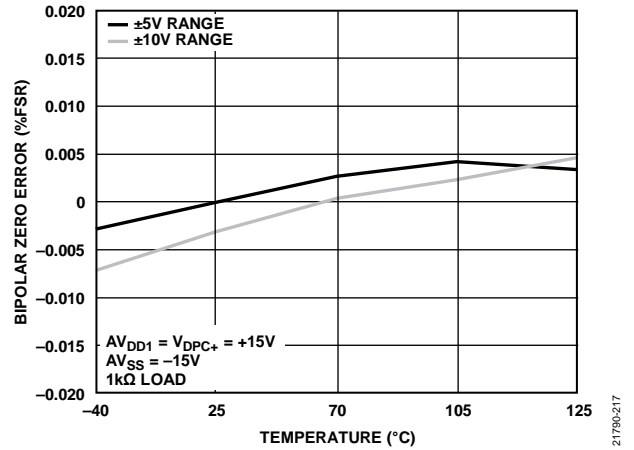

Figure 42. Bipolar Zero Error vs. Temperature

21790-217

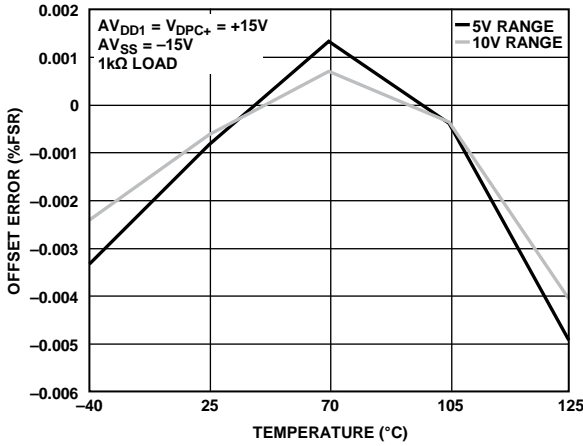

Figure 40. Offset Error vs. Temperature

21790-215

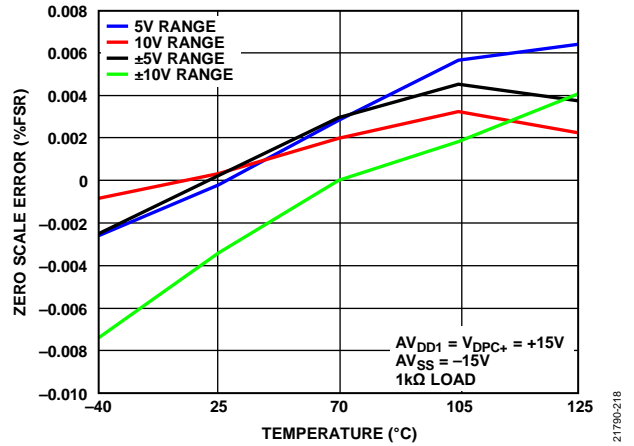

Figure 43. Zero-Scale Error vs. Temperature

21790-218

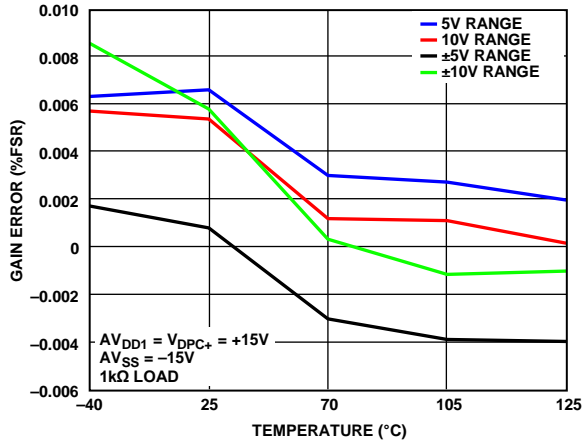

Figure 41. Gain Error vs. Temperature

21790-216

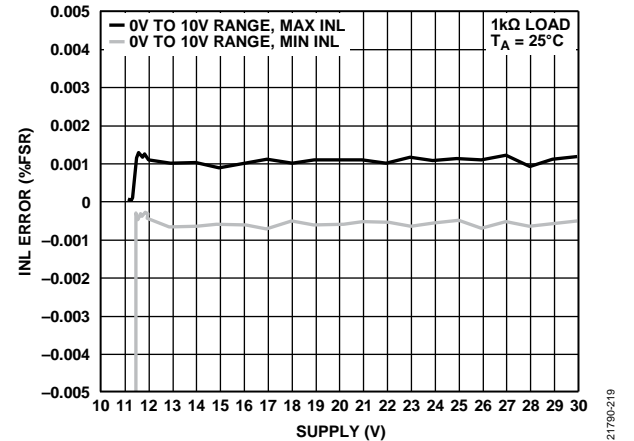

Figure 44. INL Error vs. AV_{DD1}/AV_{SS} Supply

21790-219

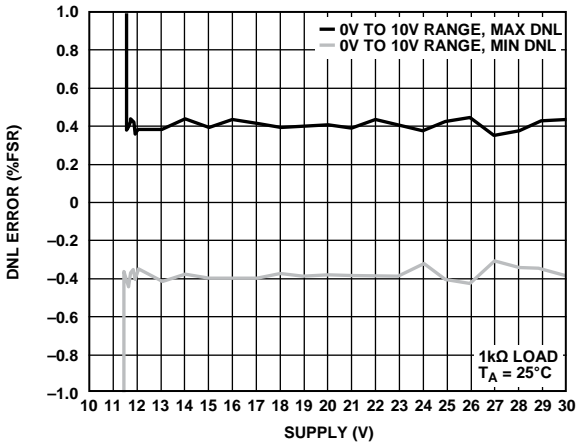

Figure 45. DNL Error vs. $AV_{DD1}/|AV_{SS}|$ Supply

21790-220

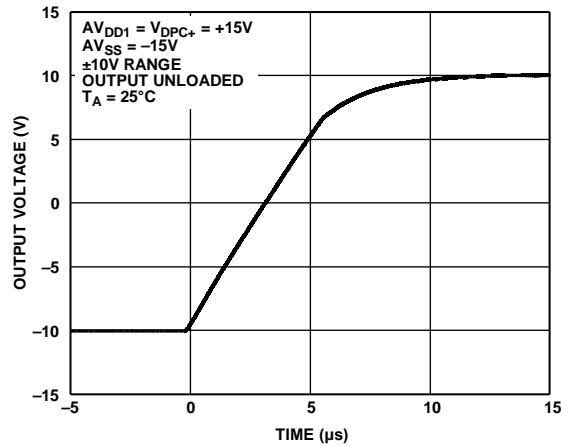

Figure 48. Full-Scale Positive Step

21790-223

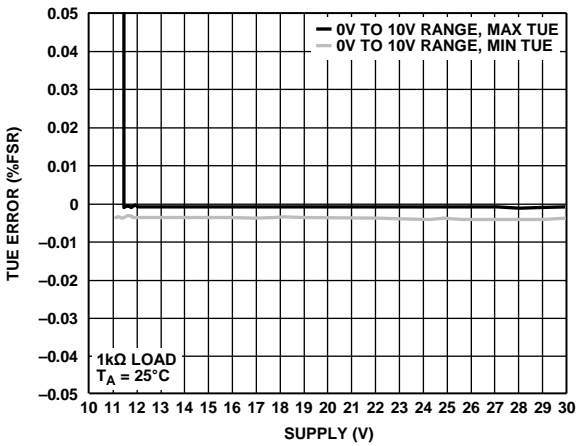

Figure 46. Total Unadjusted Error vs. $AV_{DD1}/|AV_{SS}|$ Supply

21790-221

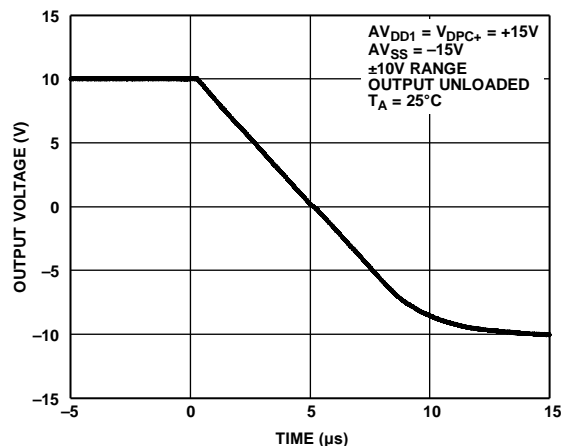

Figure 49. Full-Scale Negative Step

21790-224

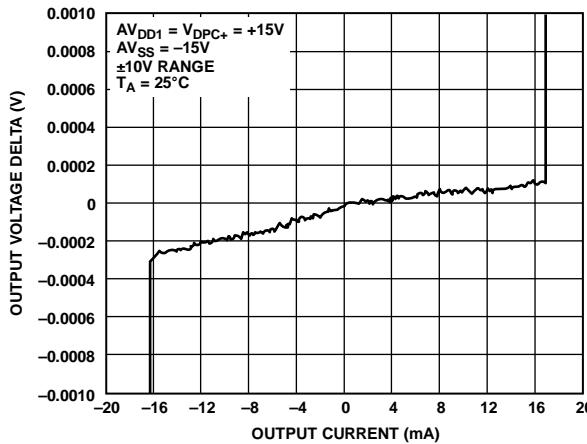

Figure 47. Sink and Source Capability of the Output Amplifier

21790-222

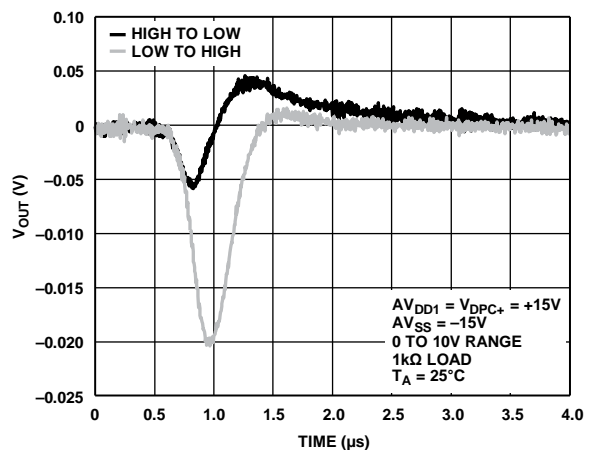

Figure 50. Digital-to-Analog Glitch Major Code Transition

21790-226

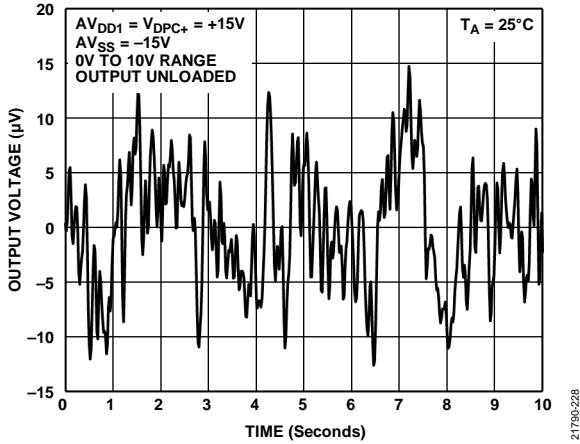

Figure 51. Peak-to-Peak Noise (0.1 Hz to 10 Hz Bandwidth)

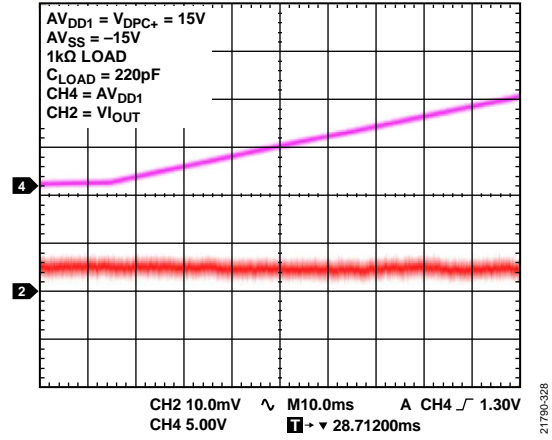

Figure 54. V_{OUT} vs. Time on Power-Up

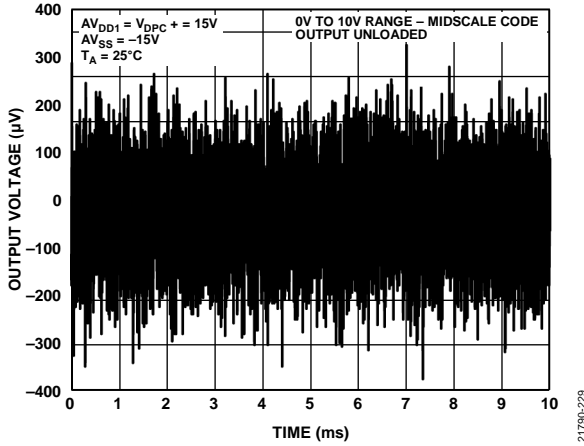

Figure 52. Peak-to-Peak Noise (100 kHz Bandwidth)

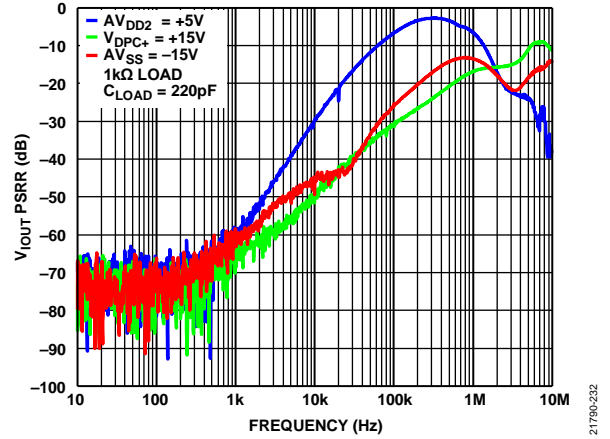

Figure 55. V_{OUT} PSRR vs. Frequency

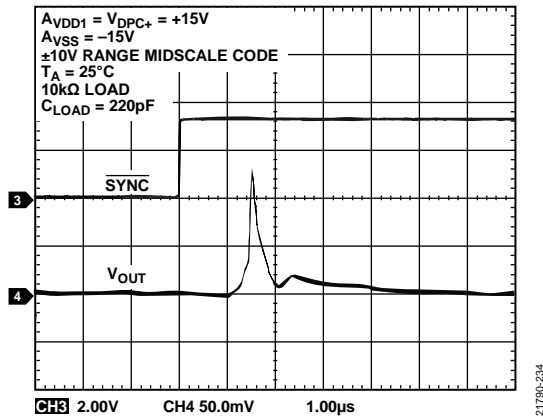

Figure 53. V_{OUT} vs. Time on Output Enable

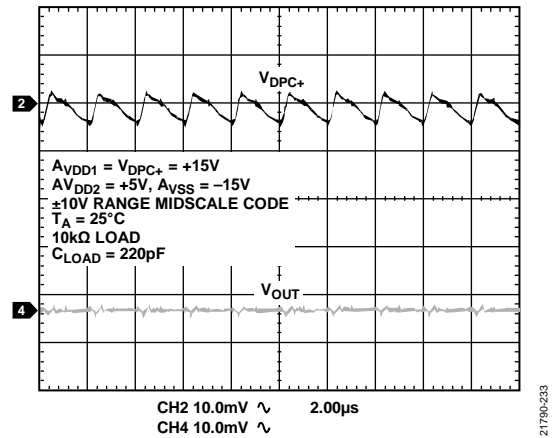

Figure 56. Voltage Output Ripple

DC-TO-DC BLOCK

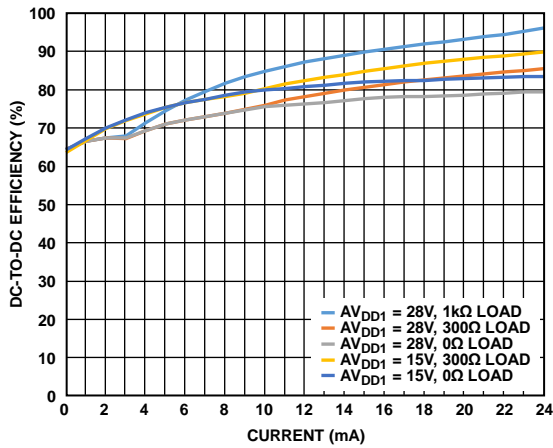

Figure 57. DC-to-DC Efficiency vs. Current

21790-283

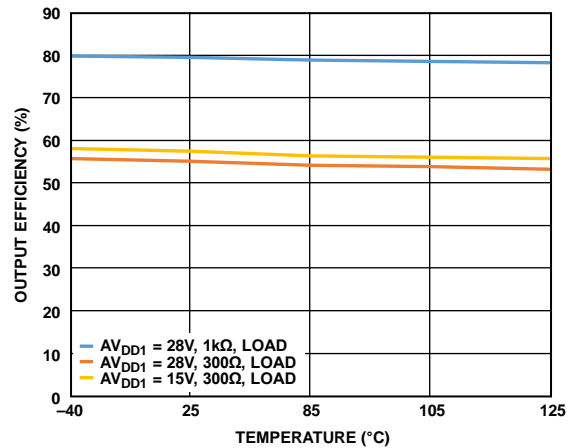

Figure 60. Output Efficiency vs. Temperature

21790-288

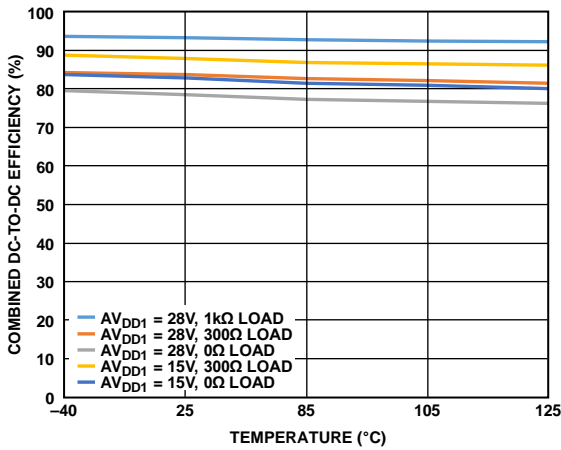

Figure 58. Combined DC-to-DC Efficiency vs. Temperature

21790-357

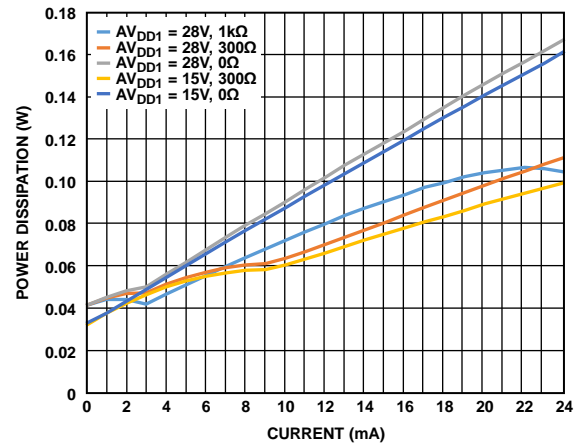

Figure 61. Power Dissipation vs. Current

21790-286

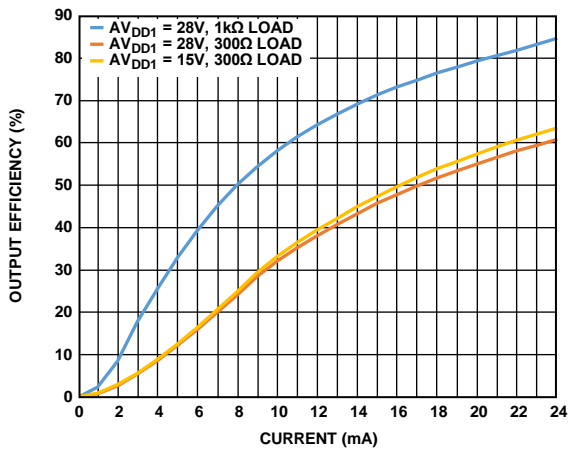

Figure 59. Output Efficiency vs. Current

21790-284

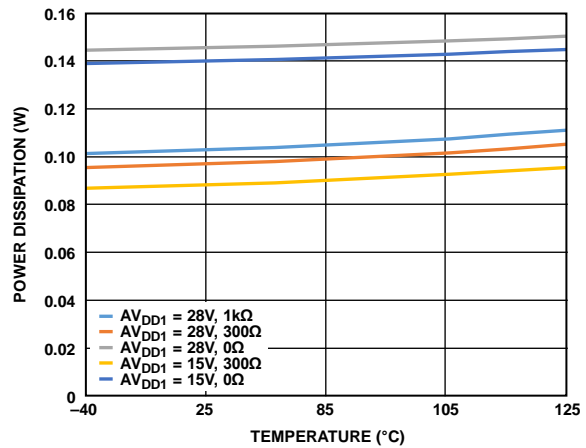

Figure 62. Power Dissipation vs. Temperature

21790-285

REFERENCE

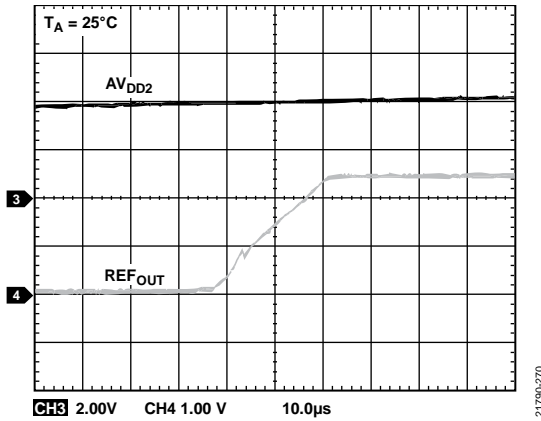

Figure 63. REFOUT Turn On Transient

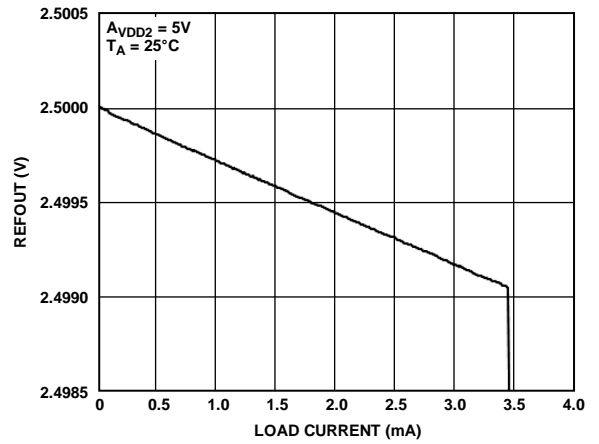

Figure 66. REFOUT vs. Load Current

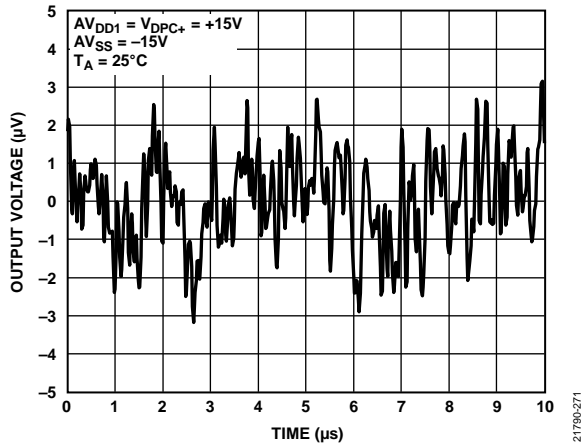

Figure 64. Peak-to-Peak Noise (0.1 Hz to 10 Hz Bandwidth)

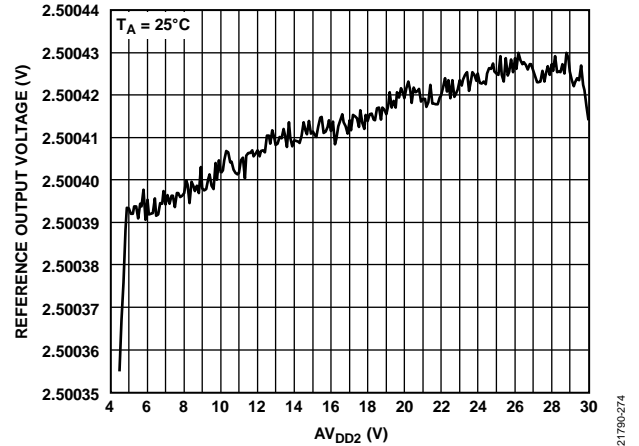

Figure 67. Reference Output Voltage vs. AVDD2 Supply

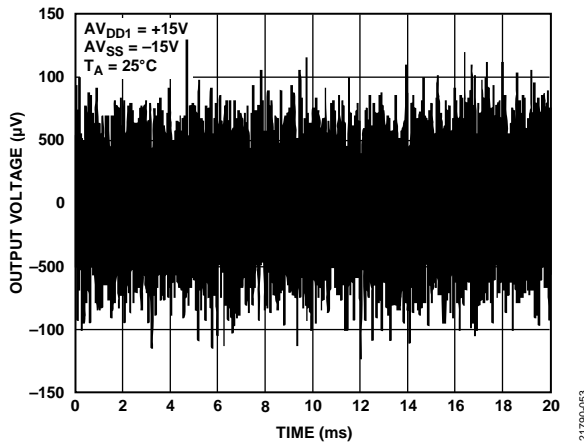

Figure 65. Peak-to-Peak Noise (100 kHz Bandwidth)

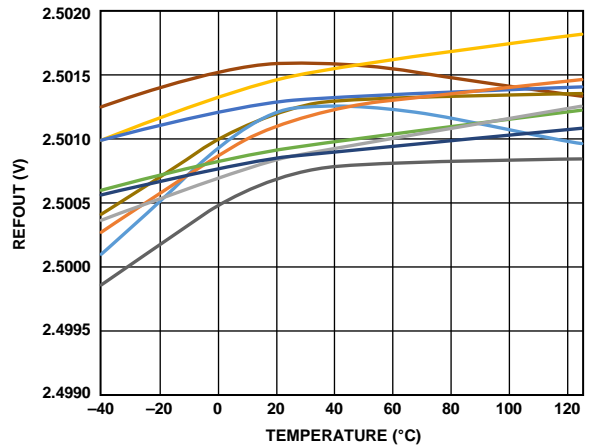

Figure 68. REFOUT vs. Temperature

GENERAL

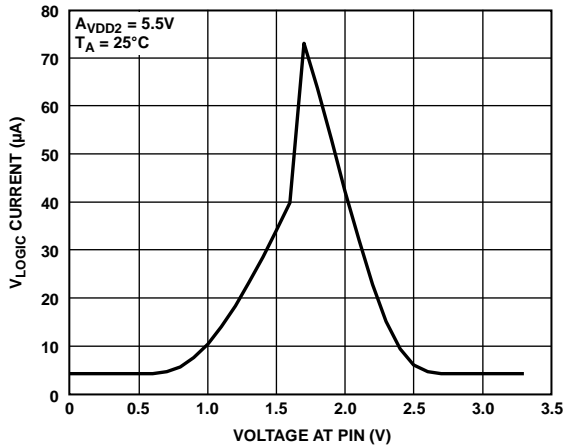

Figure 69. V_{Logic} Current vs. Logic Input Voltage

21790-281

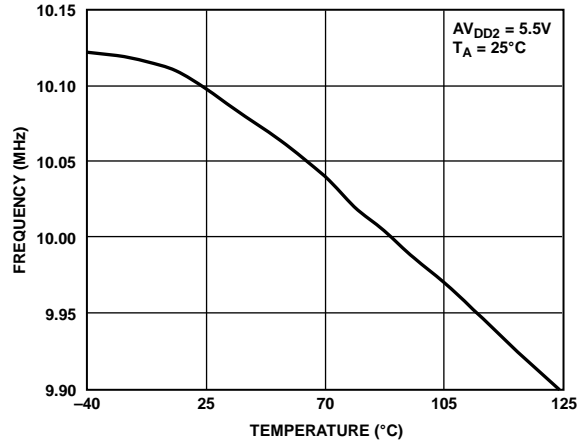

Figure 72. Internal Oscillator Frequency vs. Temperature

21790-282

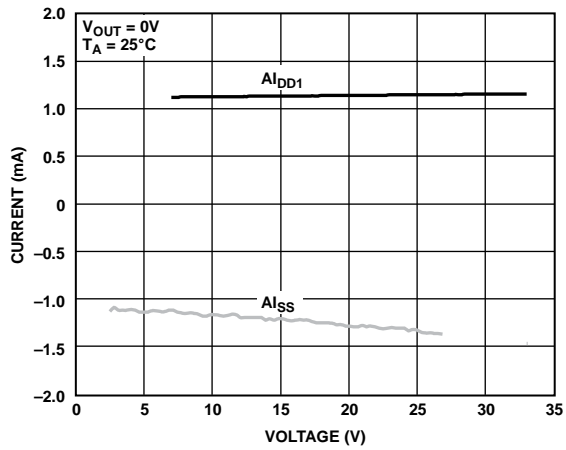

Figure 70. I_{DD1}/I_{SS} Current vs. $AV_{DD1}/AV_{SS}|$ Supply

21790-278

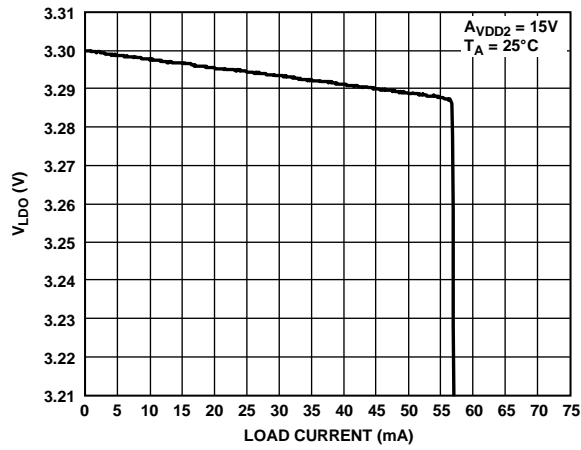

Figure 73. V_{LDO} vs. Load Current

21790-276

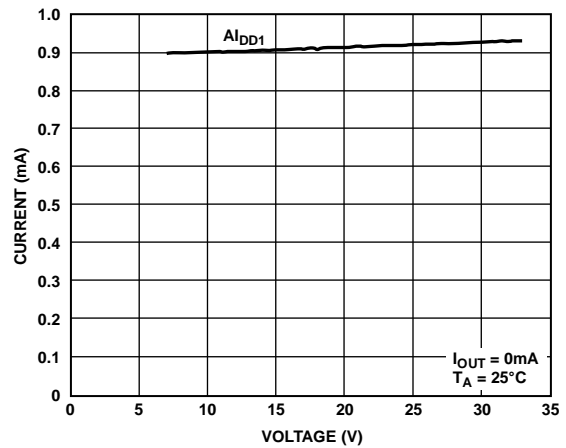

Figure 71. I_{DD1} Current vs AV_{DD1} Supply

21790-279

TERMINOLOGY

Total Unadjusted Error (TUE)

TUE is a measure of the output error taking all the various errors into account, namely INL error, offset error, gain error, and output drift over supplies, temperature, and time. TUE is expressed in % FSR.

Relative Accuracy or Integral Nonlinearity (INL)

For the DAC, relative accuracy, or INL, is a measure of the maximum deviation, in LSBs or % FSR, from the best fit line passing through the DAC transfer function.

Differential Nonlinearity (DNL)

DNL is the difference between the measured change and the ideal 1 LSB change between any two adjacent codes. A specified differential nonlinearity of ± 1 LSB maximum ensures monotonicity.

Monotonicity

A DAC is monotonic if the output either increases or remains constant for increasing digital input code. The ADFS5758 is monotonic over its full operating temperature range.

Zero-Scale/Negative Full-Scale Error

Zero-scale/negative full-scale error is the error in the DAC output voltage when 0x0000 (straight binary coding) is loaded to the DAC output register.

Zero-Scale Temperature Coefficient (TC)

Zero-scale TC is a measure of the change in zero-scale error with a change in temperature. Zero-scale error TC is expressed in ppm FSR/ $^{\circ}$ C.

Bipolar Zero Error

Bipolar zero error is the deviation of the analog output from the ideal half-scale output of 0 V when the DAC output register is loaded with 0x8000 (straight binary coding).

Bipolar Zero Temperature Coefficient (TC)

Bipolar zero TC is a measure of the change in the bipolar zero error with a change in temperature. It is expressed in ppm FSR/ $^{\circ}$ C.

Offset Error

Offset error is the deviation of the analog output from the ideal and is measured using $\frac{1}{4}$ scale and $\frac{3}{4}$ scale digital code measurements. It is expressed in % FSR.

Offset Error (TC)

Offset error TC is a measure of the change in the offset error with a change in temperature. It is expressed in ppm FSR/ $^{\circ}$ C.

Gain Error

Gain error is a measure of the span error of the DAC. It is the deviation in slope of the DAC transfer characteristic from the ideal expressed in % FSR.

Gain Error Temperature Coefficient (TC)

Gain error TC is a measure of the change in gain error with changes in temperature. Gain error TC is expressed in ppm FSR/ $^{\circ}$ C.

Full-Scale Error

Full-scale error is a measure of the output error when full-scale code is loaded to the DAC output register. Ideally, the output is full-scale $- 1$ LSB. Full-scale error is expressed in % FSR.

Headroom

Headroom is the difference between the voltage required at the output (programmed voltage in voltage output mode and programmed current $\times R_{LOAD}$ in current output mode) and the voltage supplied by the positive supply rail, V_{DPC+} . Headroom is relevant when the output is positive with respect to ground.

Footroom

Footroom is the difference between the voltage required at the output (programmed voltage in voltage output mode and programmed current $\times R_{LOAD}$ in current output mode) and the voltage supplied by the negative supply rail, AV_{SS} . Footroom is relevant when the output is negative with respect to ground.

$V_{OUT}/-V_{SENSE}$ Common-Mode Rejection Ratio (CMRR)

$V_{OUT}/-V_{SENSE}$ CMRR is the error in V_{OUT} voltage due to changes in $-V_{SENSE}$ voltage.

Current Loop Compliance Voltage

The maximum voltage at the VI_{OUT} pin for which the output current is equal to the programmed value.

Voltage Reference Thermal Hysteresis

Voltage reference thermal hysteresis is the difference in output voltage measured at 25 $^{\circ}$ C compared to the output voltage measured at 25 $^{\circ}$ C after cycling the temperature from 25 $^{\circ}$ C to -40° C to +105 $^{\circ}$ C and then back to 25 $^{\circ}$ C.

Voltage Reference TC

Voltage reference TC is a measure of the change in the reference output voltage with a change in temperature. The reference TC is calculated using the box method, which defines the TC as the maximum change in the reference output over a given temperature range expressed in ppm/ $^{\circ}$ C, as follows:

$$TC = \left(\frac{V_{REF_MAX} - V_{REF_MIN}}{V_{REF_NOM} \times TempRange} \right) \times 10^6$$

where:

V_{REF_MAX} is the maximum reference output measured over the total temperature range.

V_{REF_MIN} is the minimum reference output measured over the total temperature range.

V_{REF_NOM} is the nominal reference output voltage, 2.5 V.

$TempRange$ is the specified temperature range, -40° C to +105 $^{\circ}$ C.

Line Regulation

Line regulation is the change in reference output voltage due to a specified change in power supply voltage. It is expressed in ppm/V.

Load Regulation

Load regulation is the change in reference output voltage due to a specified change in reference load current. It is expressed in ppm/mA.

Dynamic Power Control (DPC)

In this mode, the ADFS5758 circuitry senses the output voltage and dynamically regulates the supply voltage, V_{DPC+} , to meet compliance requirements plus an optimized headroom voltage for the output buffer.

Programmable Power Control (PPC)

In this mode, the V_{DPC+} voltage is user programmable to a fixed level that must accommodate the maximum output load required.

Output Voltage Settling Time

Output voltage settling time is the amount of time it takes for the output to settle to a specified level for a full-scale input change. This specification depends on the manner in which the DPC feature is configured (enabled, disabled, or PPC mode enabled) and on the characteristics of the external dc-to-dc inductor and capacitor components used.

Slew Rate

The slew rate of a device is a limitation in the rate of change of the output voltage. The output slewing speed of a voltage output DAC is usually limited by the slew rate of the amplifier used at its output. Slew rate is measured from 10% to 90% of the output signal and is expressed in V/ μ s.

Power-On Glitch Energy

Power-on glitch energy is the impulse injected into the analog output when the ADFS5758 is powered on. It is specified as the area of the glitch in nV-sec.

Digital-to-Analog Glitch Energy

Digital-to-analog glitch energy is the energy of the impulse injected into the analog output when the input code in the DAC output register changes state. It is normally specified as the area of the glitch in nV-sec. Worst case is usually when the digital input code is changed by 1 LSB at the major carry transition (0x7FFF to 0x8000).

Glitch Impulse Peak Amplitude

Glitch impulse peak amplitude is the peak amplitude of the impulse injected into the analog output when the input code in the DAC output register changes state. It is specified as the amplitude of the glitch in millivolts and worst case is usually when the digital input code is changed by 1 LSB at the major carry transition (0x7FFF to 0x8000).

Digital Feedthrough

Digital feedthrough is a measure of the impulse injected into the analog output of the DAC from the digital inputs of the DAC but is measured when the DAC output is not updated (\overline{LDAC} pin is held high). It is specified in nV-sec and measured with a full-scale code change on the data bus.

Power Supply Rejection Ratio (PSRR)

PSRR indicates how the output of the DAC is affected by changes in the power supply voltage.

THEORY OF OPERATION

The ADFS5758 is a single-channel, precision voltage and current output DAC, designed to meet the requirements of industrial factory automation and process control applications. The ADFS5758 provides a high precision, fully integrated, single-chip solution for generating a unipolar/bipolar current or voltage output. Package power dissipation is minimized by incorporating on-chip DPC, which is achieved by regulating the supply voltage (V_{DPC+}) to the V_{IOUT} output driver from 4.95 V to 27 V using a buck dc-to-dc converter, optimized for minimum on-chip power dissipation. The ADFS5758 consists of a two-die solution with the dc-to-dc converter circuitry and the V_{IOUT} line protector located on the dc-to-dc die, and the remaining circuitry on the main die. Interdie communication is performed over an internal 3-wire interface.

FUNCTIONAL SAFETY OPERATION

The ADFS5758 is a DAC that features integrated monitoring function and diagnostics. The ADFS5758 meets all relevant requirements of IEC 61508 and is approved by TÜV Rheinland. The ADFS5758 meets SIL 2 for a nonredundant configuration in terms of the hardware fault metrics (PFH, SFF) and systematic capability of SC3 in terms of avoidance of systematic errors according to IEC 61508. The ADFS5758 features an integrated independent ADC for enhanced diagnostic measurements. The safety function defined for the ADFS5758 takes a digital input code and produces an output unipolar current to within $\pm 2.5\%$ of the full-scale range, proportional to the digital input code. For example, 2.5% of a 4 mA to 20 mA range is 400 μ A. Therefore, the output current is within $\pm 400 \mu$ A of the programmed output. If the safety function is compromised (a fault is detected in the system), the safe state for the ADFS5758 is open circuit/high impedance. The diagnostic coverage (DC) of the ADFS5758 for an assumed use case is $>90\%$. A detailed description of the configuration, operation, SFF calculations, FIT data, and other required metrics for the ADFS5758 in a functionally safe application can be found in the ADFS5758 Safety Manual (available by request). Die and pin FME(D)As have also been completed and are available (in addition to the Safety Manual) on request from Analog Devices, Inc.

DAC ARCHITECTURE

The DAC core architecture of the ADFS5758 consists of a voltage mode R-2R ladder network. The voltage output of the DAC core is converted to either a current or voltage output at the V_{IOUT} pin. Only one mode can be enabled at any one time. Both the voltage and current output stages are supplied by the V_{DPC+} power rail (internally generated from AV_{DD1}) and the AV_{SS} rail.

Current Output Mode

If current output mode is enabled, the voltage output from the DAC is converted to a current (see Figure 74), which is then mirrored to the supply rail so that the application only sees a current source output.

The current ranges available are 0 mA to 20 mA, 0 mA to 24 mA, 4 mA to 20 mA, ± 20 mA, ± 24 mA and -1 mA to $+22$ mA. An internal or external 13.7 k Ω R_{SET} resistor can be used for the voltage to current conversion.

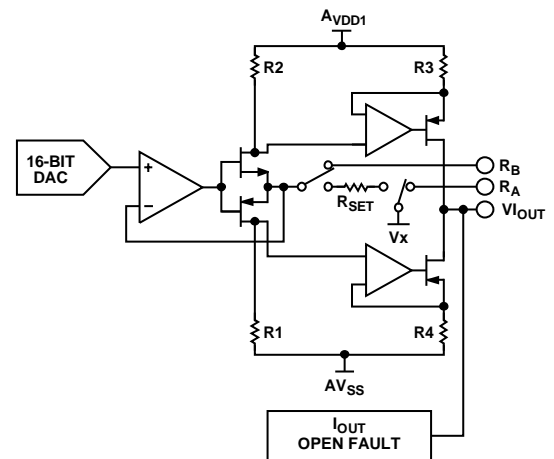

Figure 74. Voltage-to-Current Conversion Circuitry

Voltage Output Mode

If voltage output mode is enabled, the voltage output from the DAC is buffered and scaled to output a software-selectable unipolar or bipolar voltage range (see Figure 75).

The voltage ranges available are 0 V to 5 V, ± 5 V, 0 V to 10 V, and ± 10 V. A 20% overrange feature is also available (via the DAC_CONFIG register) as well as the facility to negatively offset the unipolar voltage ranges via the GP_CONFIG1 register (see the General-Purpose Configuration 1 Register section).

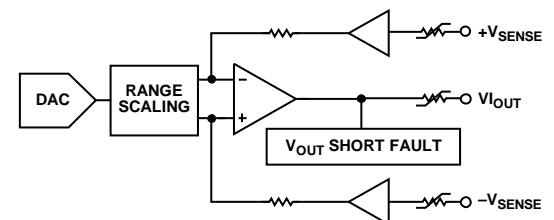

Figure 75. Voltage Output

Reference

The ADFS5758 can operate with either an external or internal reference. The reference input requires a 2.5 V reference for specified performance. This input voltage is then internally buffered before it is applied to the DAC.

The ADFS5758 contains an integrated buffered 2.5 V voltage reference that is externally available for use elsewhere within the system. The internal reference drives the integrated 12-bit ADC. REFOUT must be connected to REFIN to use the internal reference to drive the DAC.

SERIAL INTERFACE

The ADFS5758 is controlled over a versatile 4-wire serial interface that operates at clock rates of up to 50 MHz and is compatible with SPI, QSPI, MICROWIRE, and DSP standards. Data coding is always straight binary.

Input Shift Register

With SPI CRC enabled (default state), the input shift register is 32 bits wide. Data is loaded into the device MSB first as a 32-bit word under the control of a serial clock input, SCLK. Data is clocked in on the falling edge of SCLK. If CRC is disabled, the serial interface is reduced to 24 bits. A 32-bit frame is still accepted, but the last eight bits are ignored. See the Register Map section for full details on the registers that can be addressed via the SPI interface.

Table 7. Writing to a Register (CRC Enabled)

MSB		LSB		
D31	D30:D29	D28:D24	D23:D8	D7:D0
Slip Bit	ADFS5758 address	Register address	Data	CRC

Transfer Function

Table 8 shows the input code to ideal output voltage relationship for the ADFS5758 for straight binary data coding of the ±5 V output range.

Table 8. Ideal Output Voltage to Input Code Relationship

Digital Input, Straight Binary Data Coding				Analog Output
MSB		LSB		V _{out}
1111	1111	1111	1111	+2 × V _{REF} × (32,767/32,768)
1111	1111	1111	1110	+2 × V _{REF} × (32,766/32,768)
1000	0000	0000	0000	0 V
0000	0000	0000	0001	-2 × V _{REF} × (32,767/32,768)
0000	0000	0000	0000	-2 × V _{REF}

POWER-ON STATE OF THE ADFS5758

On initial power-on or a device reset, the voltage and current output channel is disabled. The switch connecting V_{IOUT} via a 30 kΩ pull-down resistor to AGND is open. This switch can be configured in the DCDC_CONFIG2 register. V_{DPC+} is internally driven to 4.8 V on power-on until the dc-to-dc converter is enabled.

After device power-on, or a device reset, a calibration memory refresh command is required (see the Echo Mode section). It is recommended to wait 500 μs minimum after writing this command, before writing further instructions to the device to allow time for internal calibrations to take place (see Figure 93).

Power-On Reset

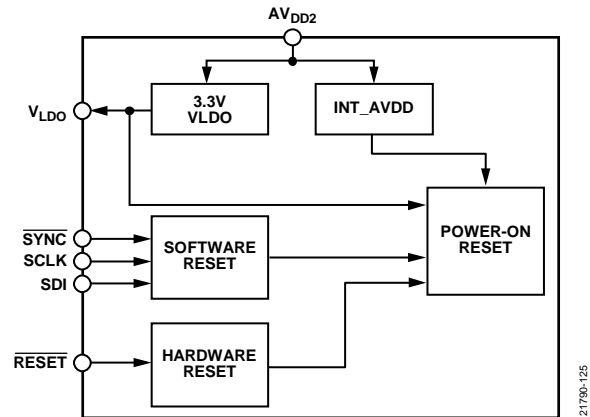

Figure 76. Power-On Reset Block Diagram

The ADFS5758 incorporates a power-on reset circuit that ensures the ADFS5758 is held in reset while the power supplies are at a level insufficient to allow reliable operation. The power-on reset circuit (see Figure 76) monitors the AV_{DD2} generated VLDO and INT_AVCC voltages, the RESET pin, and the SPI reset signal. The power-on reset circuit keeps the ADFS5758 in reset until the voltages on the VLDO, and INT_AVCC nodes are sufficient for reliable operation. If the power-on circuit receives a signal from the RESET pin or if a software reset is written to the ADFS5758 via the SPI interface, the ADFS5758 is reset. Do not write SPI commands to the device within 100 μs of a reset event.

POWER SUPPLY CONSIDERATIONS

The ADFS5758 has four supply rails: AV_{DD1}, AV_{DD2}, AV_{SS}, and V_{LOGIC}. See the Specifications section for the voltage range of the four supply rails and the associated conditions.

AV_{DD1} Considerations

AV_{DD1} is the supply rail for the dc-to-dc converter and can range from 7 V to 33 V. Although the maximum value of AV_{DD1} is 33 V and the minimum value of AV_{SS} is -33 V, the maximum operating range of |AV_{DD1} to AV_{SS}| is 60 V. V_{DPC+} is derived from AV_{DD1}, and its value depends on the mode of operation of the dc-to-dc converter.

The dc-to-dc converter requires a sufficient level of margin to be maintained between AV_{DD1} and V_{DPC+} to ensure the dc-to-dc circuitry operates correctly. This margin is 5% of the maximum V_{DPC+} voltage for a given mode of operation.

Table 9. AV_{DD1} to V_{DPC+} Margin

Mode of Operation	V _{DPC+} Maximum
DPC Voltage Mode	15 V
DPC Current Mode	(I _{OUT} maximum × R _{LOAD}) + I _{OUT} headroom
PPC Current Mode	DCDC_CONFIG1, Bits[4:0] programmed value

See the Power Dissipation Control section for further details on the dc-to-dc converter modes of operation.

Calculating Supply Voltage

Assuming DPC current mode, use the following equations to calculate the voltage and current values:

$$V_{DPC+ \text{ Maximum}} = I_{OUT \text{ Maximum Voltage}} + I_{OUT \text{ Headroom}} = 22.5 \text{ V}$$

where:

$$I_{OUT \text{ Maximum}} = 20 \text{ mA (} R_{LOAD} = 1 \text{ k}\Omega\text{)}.$$

$$I_{OUT \text{ Maximum Voltage}} \text{ is } I_{OUT \text{ Maximum}} \times R_{LOAD} = 20 \text{ V.}$$

$$I_{OUT \text{ Headroom}} = 2.5 \text{ V.}$$

$|V_{DPC+} \text{ to } AV_{DD1}|$ headroom can be calculated as 5% of 22.5 V = 1.125 V. Therefore, $AV_{DD1} \text{ minimum} = 22.5 \text{ V} + 1.125 \text{ V} = 23.625 \text{ V}$. Assuming a worst case AV_{DD1} supply rail tolerance of $\pm 10\%$, this example requires an AV_{DD1} supply rail of approximately 26.25 V.

AV_{SS} Considerations

AV_{SS} is the negative supply rail and has a range of -33 V to 0 V . As in the case of AV_{DD1} , AV_{SS} must obey the maximum operating range of $|AV_{DD1} \text{ to } AV_{SS}|$ of 60 V. For bipolar current output ranges, the maximum AV_{SS} can be calculated as $(I_{OUT_MAX} \times R_{LOAD}) + I_{OUT}$ footroom. For unipolar current output ranges, AV_{SS} can be tied to AGND (that is, 0 V). For unipolar voltage output ranges, the maximum AV_{SS} is -2 V to enable sufficient footroom for the internal voltage output circuitry. To avoid power supply sequencing issues, a Schottky diode must be placed between AV_{SS} and GND (the GND supply must always be available).

AV_{DD2} Considerations

AV_{DD2} is the positive low voltage supply rail and has a range of 5 V to 33 V. If only one positive power rail is available, AV_{DD2} can be tied to AV_{DD1} . However, to optimize for reduced power dissipation, supply AV_{DD2} with a separate lower voltage supply.

V_{LOGIC} Considerations

V_{LOGIC} is the digital supply for the device and can range from 1.71 V to 5.5 V. The 3.3 V V_{LDO} output voltage can be used to drive V_{LOGIC} .

DEVICE FEATURES AND DIAGNOSTICS

POWER DISSIPATION CONTROL

The ADFS5758 contains integrated buck dc-to-dc converter circuitry that controls the power supply to the output buffers, allowing reductions in power consumption from standard designs when using the device in both current and voltage output modes. AV_{DD1} is the supply rail for the dc-to-dc converter and can range from 7 V to 33 V. V_{DPC+} is derived from this rail and its value depends on the mode of operation of the dc-to-dc converter as well as the output load, including DPC voltage mode, DPC current mode, and PPC current mode.

Figure 77 shows the discrete components needed for the dc-to-dc circuitry and the following sections describe component selection and operation of this circuitry.

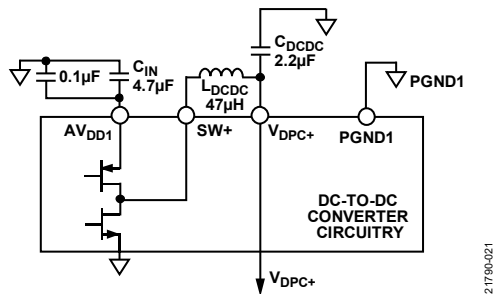

Figure 77. DC-to-DC Circuit

Table 10. Recommended DC-to-DC Components

Symbol	Component	Value	Manufacturer
L_{DCCDC}	LPS4018-473MRB	47 μ H	Coilcraft
C_{DCCDC}	GCM31CR71H225KA55L	2.2 μ F	Murata
C_{IN}	GRM31CR71H475KA12L	4.7 μ F	Murata

DC-to-DC Converter Operation

The dc-to-dc converter uses a fixed 500 kHz frequency, peak current mode control scheme to step down the AV_{DD1} input to produce V_{DPC+} to supply the driver circuitry of the voltage/current output channel. The dc-to-dc converter incorporates a low-side synchronous switch and, therefore, does not require an external Schottky diode. The dc-to-dc converter is designed to operate predominantly in discontinuous conduction mode (DCM), where the inductor current goes to zero for an appreciable percentage of the switching cycle. To avoid generating lower frequency harmonics on the V_{DPC+} regulated output voltage rail, the dc-to-dc converter does not skip any cycles. Therefore, the dc-to-dc converter must transfer a minimum amount of energy to its load (that is, the current or voltage output stage and its respective load) to operate at a fixed frequency. Thus, for light loads (for example, low R_{LOAD} or low I_{OUT}), the V_{DPC+} voltage can rise beyond the target value and go out of regulation. This is not a fault condition and does not represent the worst case power dissipation condition in an application.

Note that the dc-to-dc converter requires a sufficient level of margin to be maintained between AV_{DD1} and V_{DPC+} to ensure the dc-to-dc circuitry operates correctly. This margin value is 5% of V_{DPC+} maximum.

DPC Voltage Mode

In DPC voltage mode, with the voltage output enabled or disabled, the converter regulates the V_{DPC+} supply to 15 V above the $-V_{SENSE}$ voltage. This mode allows the full output voltage range to be efficiently applied across remote loads, with corresponding remote grounds at up to ± 10 V potential relative to the local ground supply (AGND) for the ADFS5758.

DPC Current Mode

In standard current input module designs, the combined line and load resistance values can range from typically 50 Ω to 750 Ω . Output module systems must provide enough voltage to meet the compliance voltage requirement across the full range of load resistor values. For example, in a 4 mA to 20 mA loop, when driving 20 mA into a 750 Ω load, a compliance voltage of >15 V is required. When driving 20 mA into a 50 Ω load, the required compliance is reduced to >1 V.

In DPC current mode, the ADFS5758 dc-to-dc circuitry senses the output voltage and regulates the V_{DPC+} supply voltage to meet compliance requirements plus an optimized headroom voltage for the output buffer. V_{DPC+} is dynamically regulated to 4.95 V or ($I_{OUT} \times R_{LOAD} + \text{headroom}$), whichever is greater. This regulation excludes the light load condition whereby the V_{DPC+} voltage can rise beyond the target value, which does not represent the worst case power dissipation condition in an application. The ADFS5758 is capable of driving up to 24 mA through a 1 k Ω load, for a given input supply (24 V + headroom).

At low output power levels, the regulated headroom increases above 2.3 V because the dc-to-dc circuitry uses a minimum on time ADFS5758 cycle. This behaviour is expected and does not impact any worse case power dissipation.

PPC Current Mode

The dc-to-dc converter can also operate in programmable power control mode, where the V_{DPC+} voltage is user programmable to a given level to accommodate the maximum output load required. This mode represents a trade-off between the optimized power efficiency of the DPC current mode and the settling time of a system with a fixed supply (dc-to-dc disabled). In PPC current mode, V_{DPC+} is regulated to a user-programmable level between 5 V and 25.677 V with respect to $-V_{SENSE}$ (in steps of 0.667 V). This mode is useful if settling time is an important requirement of the design. See the DC-to-DC Converter Settling Time section. Care is needed in selecting the programmed level of V_{DPC+} if the load is nonlinear in nature. V_{DPC+} must be set high enough to obey the output compliance voltage specification. If the load is unknown, the $+V_{SENSE}$ input to the ADC can be used to monitor the V_{IOUT} pin in current mode to determine the user-programmable value at which to set V_{DPC+} .

DC-to-DC Converter Settling Time

When in DPC current mode, the settling time is dominated by the settling time of the dc-to-dc converter and is typically 200 μ s without the digital slew rate control feature enabled. To reduce initial V_{IOUT} waveform overshoot without adding a capacitor on V_{IOUT} and thereby affecting HART operation, enable the digital slew rate control feature using the DAC_CONFIG register (see Table 34).

Table 11 shows the typical settling time for each of the dc-to-dc converter modes. All values shown assume the use of the components recommended by Analog Devices listed in Table 10. The achievable settling time in any given application is dependent on the choice of external inductor and capacitor components used, as well as the current-limit setting of the dc-to-dc converter.

Table 11. DC-to-DC Converter Mode vs. Settling Time

DC-to-DC Converter Mode	Settling Time (μ s)
DPC Current Mode	200
PPC Current Mode	15
DPC Voltage Mode	15

DC-to-DC Converter Inductor Selection

For typical 4 mA to 20 mA applications, a 47 μ H inductor (per Table 10), combined with the switching frequency of 500 kHz, allows up to 24 mA to be driven into a load resistance of up to 1 k Ω with an AV_{DD1} supply of greater than 24 V + headroom. It is important to ensure that the peak current does not cause the inductor to saturate, especially at the maximum ambient temperature. If the inductor enters saturation mode, it results in a decrease in efficiency. Larger size inductors translate to lower core losses. The slew rate control feature of the ADFS5758 can be used to limit peak currents during slewing. Program an appropriate current limit (via the DCDC_CONFIG2 register) to shut off the internal switch if the inductor current reaches that limit.

DC-to-DC Converter Input and Output Capacitor Selection

The output capacitor, C_{DCDC} , affects the ripple voltage of the dc-to-dc converter and limits the maximum slew rate at which the output current can rise. The ripple voltage is directly related to the output capacitance. The C_{DCDC} capacitor recommended by Analog Devices (see Table 10), combined with the recommended 47 μ H inductor, results in a 500 kHz ripple with amplitude less than 50 mV and guarantees stability and operation with HART capability across all operating modes.

For high voltage capacitors, the size of the capacitor is often a good indication of its charge storage ability. It is important to characterize the dc bias voltage vs. capacitance curve for this capacitor. Any capacitance values specified are with reference to a dc bias corresponding to the maximum V_{DPC+} voltage in the application. As well as the voltage rating, the temperature range of the capacitor must also be considered for a given application. These considerations are key in selection of the components described in Table 10.

The input capacitor, C_{IN} , provides much of the dynamic current required for the dc-to-dc converter, and a low effective series resistance (ESR) component is recommended. For the ADFS5758, a low ESR tantalum or ceramic capacitor of 4.7 μ F (1206 size) in parallel with a 0.1 μ F (0402 size) capacitor is recommended. Ceramic capacitors must be chosen carefully because they can exhibit a large sensitivity to dc bias voltages and temperature. X5R or X7R dielectrics are preferred because these capacitors remain stable over wider operating voltage and temperature ranges. Care must be taken if selecting a tantalum capacitor to ensure a low ESR value.

CLKOUT

The ADFS5758 provides a CLKOUT signal to the system for synchronization purposes. This signal is programmable to eight frequency options between 416 kHz and 588 kHz, with the default option being 500 kHz—the same switching frequency of the dc-to-dc converter. This feature is configured in the GP_CONFIG1 register and is disabled by default.

INTERDIE 3-WIRE INTERFACE

A 3-wire interface is used to communicate between the two die in the ADFS5758. The 3-wire interface master is located on the main die, and the 3-wire interface slave is on the dc-to-dc die. The three interface signals are data, DCLK (running at MCLK/8), and interrupt.

The main purpose of the 3-wire interface is to read from or write to the DCDC_CONFIG1 and DCDC_CONFIG2 registers. Addressing these registers via the SPI interface initiates an internal 3-wire interface transfer from the main die to the dc-to-dc die. The 3-wire interface master on the main die initiates writes and reads to the registers on the dc-to-dc die using DCLK as the serial clock. The slave uses an interrupt signal to indicate a read of the internal status register of the dc-to-dc die is required.

For every 3-wire interface write, an automatic read and compare process can be enabled (default case) to ensure that the contents of the copy of the DCDC_CONFIGx registers on the main die match the contents of the registers on the dc-to-dc die. This comparison is performed to ensure the integrity of the digital circuitry on the dc-to-dc die. With this feature enabled, a 3-wire interface transfer takes approximately 300 μ s. When disabled, this transfer time reduces to 30 μ s.

The BUSY_3WI flag in the DCDC_CONFIG2 register is asserted during the 3-wire interface transaction. The BUSY_3WI flag is also set when the user updates the DAC range (via the DAC_CONFIG register, Bits[4:0]) due to the internal calibration memory refresh caused by this action, which requires a 3-wire interface transfer between the two die. A write to either of the DCDC_CONFIGx registers must not be initiated while BUSY_3WI is asserted. If a write occurs, the new write is delayed until the current 3-wire interface (3WI) transfer completes.

3-Wire Interface Diagnostics

Any faults on the dc-to-dc die triggers an interrupt to the main die. An automatic status read of the dc-to-dc die is performed. After the read transaction, the main die has a copy of the dc-to-dc die status bits (VIOUT_OV_ERR, DCDC_P_SC_ERR and DCDC_P_PWR_ERR). These values are available in the ANALOG_DIAG_RESULTS register and via the OR'ed analog diagnostic results bits in the status register. These bits also trigger the FAULT pin.

In response to the interrupt request, the main die (master) performs a 3-wire interface read operation to read the status of the dc-to-dc die. The interrupt is only asserted again by a subsequent dc-to-dc die fault flag, upon which the 3-wire interface initiates another status read transaction. If an interrupt signal is detected six times in a row, the interrupt detection mechanism is disabled until a 3-wire interface write transaction completes. This disabling prevents the 3-wire interface from being blocked because of the constant dc-to-dc die status read when the interrupt is toggling. The INTR_SAT_3WI flag in the DCDC_CONFIG2 register indicates when this event occurs, and a write to either DCDC_CONFIGx register resets this bit to 0.

During a 3-wire read or write operation, the address and data bits in the transaction produce parity bits. These parity bits are checked on the receive side and if they do not match on both die, the ERR_3WI bit in the DIGITAL_DIAG_RESULTS register is set. If the read and compare process is enabled and a parity error occurs, the BKGND_CRC_ERR bit in the DIGITAL_DIAG_RESULTS register is also set.

The FAULT_INJECT_3WI bits (in the GP_CONFIG2 register) can be used to check that the 3-wire interface diagnostics are functioning correctly.

VOLTAGE OUTPUT

Voltage Output Amplifier and V_{SENSE} Functionality

The voltage output amplifier is capable of generating both unipolar and bipolar output voltages, and is also capable of driving a load of 1 k Ω in parallel with 2 μ F (with an external compensation capacitor) to AGND. Figure 78 shows the voltage output driving a load, R_{LOAD} , on top of a common-mode voltage (V_{CM}) of ± 10 V. An integrated 2 M Ω resistor ensures the amplifier loop is kept closed, thus preventing potential large destructive voltages on V_{IOUT} due to the broken amplifier loop in applications where a cable can possibly become disconnected from $+V_{SENSE}$. If remote sensing of the load is not required, connect $+V_{SENSE}$ directly to V_{IOUT} and connect $-V_{SENSE}$ directly to AGND. Make both connections using 1 k Ω resistors.

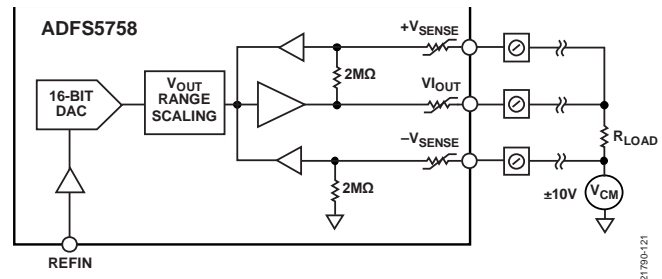

Figure 78. Voltage Output

Driving Large Capacitive Loads

The voltage output amplifier is capable of driving capacitive loads of up to 2 μ F with the addition of a 220 pF nonpolarized compensation capacitor. This capacitor, while allowing the ADFS5758 to drive higher capacitive loads and reduce overshoot, increases the settling time of the device and, therefore, affects the bandwidth of the system. Without the compensation capacitor, capacitive loads up to 10 nF can be driven.

Voltage Output Short-Circuit Protection

Under normal operation, the voltage output sinks/sources up to 12 mA and maintains specified operation. The short-circuit current is typically 15 mA. If a short circuit is detected, the FAULT pin goes low and the VIOUT_SC_ERR bit in the ANALOG_DIAG_RESULTS register is set.

FAULT PROTECTION

The ADFS5758 incorporates a line protector on the V_{IOUT} pin, $+V_{SENSE}$ pin, and $-V_{SENSE}$ pin. The line protector operates by clamping the voltage internal to the line protector to the V_{DPC+} and AV_{SS} rails, thereby protecting internal circuitry from external voltage faults. If a voltage outside of these limits is detected on the V_{IOUT} pin, an error flag (VIOUT_OV_ERR) is also set and is located in the ANALOG_DIAG_RESULTS register.

CURRENT OUTPUT

External Current Setting Resistor

As shown in Figure 74, R_{SET} is an internal sense resistor that forms part of the voltage to current conversion circuitry. The stability of the output current value over temperature is dependent on the stability of the value of R_{SET} . As a method of improving the stability of the output current over temperature, an external 13.7 k Ω low drift resistor can be connected between the R_A and R_B pins of the ADFS5758, to be used instead of the internal resistor.

Table 1 shows the performance specifications of the ADFS5758 with both the internal R_{SET} resistor and an external, 13.7 k Ω R_{SET} resistor. The external R_{SET} resistor specification assumes an ideal resistor. The actual performance depends on the absolute value and temperature coefficient of the resistor used. The resistor specifications, therefore, directly affect the gain error of the output and the TUE.

To arrive at the absolute worst case overall TUE of the output with a particular external R_{SET} resistor, add the percentage absolute error of the R_{SET} resistor directly to the TUE of the ADFS5758 with the external R_{SET} resistor, shown in Table 1 (expressed in % FSR). The temperature coefficient also must be considered, as well as the specifications of the external reference, if this is the option being used in the system.

The magnitude of the error derived from simply summing the absolute error and TC error of both the external R_{SET} resistor and the external reference with the TUE specification of the ADFS5758 is unlikely to occur because the temperature coefficients of the individual components are not likely to exhibit the same drift polarity, and, therefore, an element of cancelation occurs. For this reason, add the temperature coefficients in a root of squares fashion. A further improvement can be gained by performing a two-point calibration at zero scale and full scale, thus reducing the absolute errors of the voltage reference and the R_{SET} resistor.

Current Output Open-Circuit Detection

When in current output mode, if the headroom available falls below the compliance range due to an open-loop circuit or an insufficient power supply voltage, the `IOUT_OC_ERR` flag in the `ANALOG_DIAG_RESULTS` register is asserted, and the `FAULT` pin goes low.

HART CONNECTIVITY

The ADFS5758 has a C_{HART} pin, onto which a HART signal can be coupled. The HART signal appears on the current output if the `HART_EN` bit in the `GP_CONFIG1` register is enabled and the V_{IOUT} output is also enabled.

Figure 79 shows the recommended circuit for attenuating and coupling the HART signal to the ADFS5758. To achieve 1 mA p-p at the V_{IOUT} pin, a signal of approximately 125 mV p-p is required at the C_{HART} pin. Note that the HART signal appearing at the V_{IOUT} pin is inverted relative to the signal input at the C_{HART} pin.

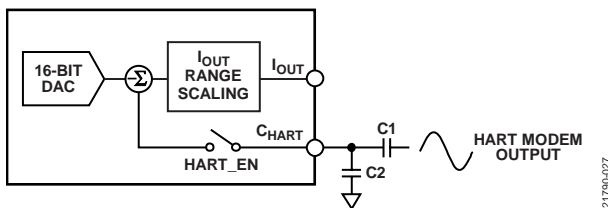

Figure 79. Coupling the HART Signal

As well as their use in attenuating the incoming HART modem signal, a minimum capacitance of the combination of $C1$ and $C2$ is required to ensure that the bandwidth presented to the modem output signal passes the 1.2 kHz and 2.2 kHz frequencies. Assuming a HART signal of 500 mV p-p, the recommended values are $C1 = 47$ nF and $C2 = 150$ nF. Digitally controlling the slew rate of the output is necessary to meet the analog rate of change requirements for HART.

If the HART feature is not required, disable the `HART_EN` bit and leave the C_{HART} pin open circuit. However, if it is required to slow the DAC output signal with a capacitor, the `HART_EN` bit must be enabled and the required C_{SLEW} capacitor connected to the C_{HART} pin.

DIGITAL SLEW RATE CONTROL

The slew rate control feature of the ADFS5758 allows the user to control the rate at which the output value changes. This feature is available in both current and voltage mode. With the slew rate control feature disabled, the output value changes at a rate limited by the output drive circuitry and the attached load. To reduce the slew rate, enable the slew rate control feature. With this feature enabled, the output steps digitally from one value to the next at a rate defined by two parameters accessible via the `DAC_CONFIG` register. The parameters are `SR_CLOCK` and `SR_STEP`. `SR_CLOCK` defines the rate at which the digital slew is updated. For example, if the selected update rate is 8 kHz, the output updates every 125 μ s. In conjunction with `SR_CLOCK`, `SR_STEP` defines by how much the output value changes at each update. Together, both parameters define the rate of change of the output value.

The following equation describes the slew rate as a function of the step size, the update clock frequency, and the LSB size:

$$\text{Slew Time} = \frac{\text{Output Change}}{\text{Step Size} \times \text{Slew Rate Frequency} \times \text{LSB Size}}$$

where:

Slew Time is expressed in seconds.

Output Change is expressed in amps for current output mode or volts for voltage output mode.

Step Size is the LSB step size (for example, $\text{LSB} = 20 \text{ mA range}/2^{16}$).

Slew Rate Frequency is `SR_CLOCK`.

LSB Size is `SR_STEP`.

When the slew rate control feature is enabled, all output changes occur at the programmed slew rate. For example, if the `WDT` times out and an automatic clear occurs, the output slews to the clear value at the programmed slew rate (setting the `CLEAR_NOW_EN` bit in the `GP_CONFIG1` register overrides this default behavior to cause the output to update to the clear code immediately rather than at the programmed slew rate).

The slew rate frequency for any given value is the same for all output ranges. The step size, however, varies across output ranges for a given value of step size because the LSB size is different for each output range.

ADFS5758 ADDRESS PINS

The ADFS5758 address pins (`AD0` and `AD1`) are used in conjunction with the ADFS5758 address bits within the SPI frame (see Table 12) to determine which ADFS5758 device is being addressed by the system controller. Using the two address pins, up to four devices can be independently addressed on one board.

SPI INTERFACE AND DIAGNOSTICS

The ADFS5758 is controlled over a 4-wire serial interface with an 8-bit cyclic redundancy check (CRC-8) enabled by default. The input shift register is 32 bits wide and data is loaded into the device MSB first under the control of a serial clock input, SCLK. Data is clocked in on the falling edge of SCLK. If CRC is disabled, the serial interface is reduced to 24 bits. A 32-bit frame is still accepted but the last eight bits are ignored.

Table 12. Writing to a Register (CRC Enabled)

MSB				LSB
D31	D30:D29	D28:D24	D23:D8	D7:D0
Slip bit	ADFS5758 address	Register address	Data	CRC

As shown in Table 12, every SPI frame contains two ADFS5758 address bits. These bits must match the hardware ADFS5758 address pins (AD0 and AD1) for a particular device to accept the SPI frame on the bus.

SPI Cyclic Redundancy Check

To verify that data has been received correctly in noisy environments, the ADFS5758 offers the option of a CRC based on an 8-bit cyclic redundancy check (CRC-8). The device controlling the ADFS5758 generates an 8-bit frame check sequence using the following polynomial:

$$C(x) = x^8 + x^2 + x^1 + 1$$

This sequence is added to the end of the data-word, and 32 bits are sent to the ADFS5758 before taking SYNC high.

If the SPI_CRC_EN bit is set high (default state), the user must supply a frame of exactly 32 bits wide that contains the 24 data bits and 8-bit CRC. If the CRC check is valid, the data is written to the selected register. If the CRC check fails, the FAULT pin goes low and the FAULT pin status and the digital diagnostic status bit (DIG_DIAG_STATUS) in the status register are set. A subsequent readback of the DIGITAL_DIAG_RESULTS register reveals that the SPI_CRC_ERR bit is also set. This register is a per bit, write to clear register (see the Sticky Diagnostic Results Bits section). Therefore, the SPI_CRC_ERR bit can be cleared by writing a 1 to Bit D0 of the DIGITAL_DIAG_RESULTS register. Doing so clears the SPI_CRC_ERROR bit and causes the FAULT pin to return high (assuming that there are no other active faults). When configuring the FAULT_PIN_CONFIG register, the user can decide whether the SPI CRC error affects the FAULT pin. See the FAULT Pin Configuration Register section for further details. The SPI CRC feature can be used for both the transmission and receipt of data packets.

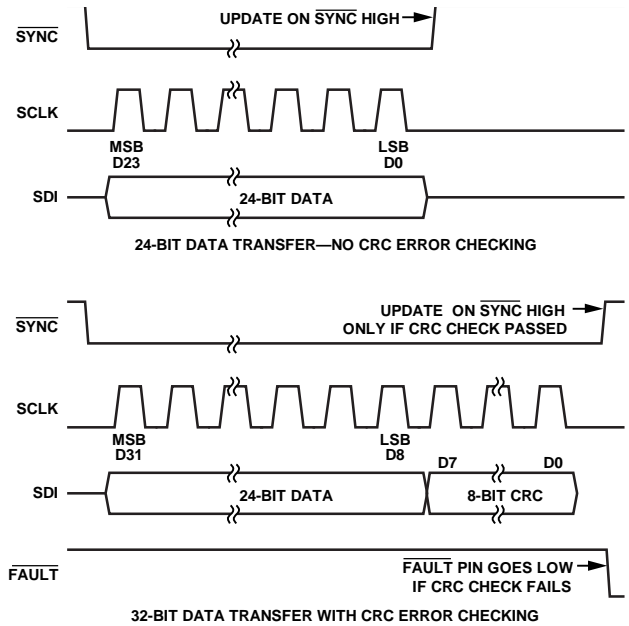

Figure 80. CRC Timing (Assume LDAC = 0)

SPI Interface Slip Bit

A further enhancement to the robustness of the interface is the addition of the slip bit. The MSB of the SPI frame must equal the inverse of MSB – 1 for the frame to be considered valid. If an incorrect slip bit is detected, the data is ignored and the SLIPBIT_ERR bit in the DIGITAL_DIAG_RESULTS register is asserted.

SPI Interface SCLK Count Feature

An SCLK count feature is also built into the SPI diagnostics, meaning that only SPI frames with exactly 32 SCLK falling edges (24 or 32 if SPI CRC is enabled) are accepted by the interface as a valid write. SPI frames of lengths other than these are ignored and the SCLK_COUNT_ERR flag asserts in the DIGITAL_DIAG_RESULTS register.

Readback Modes

The ADFS5758 offers four readback modes, as follows:

- Two-stage readback mode
- Autostatus readback mode
- Shared SYNC autostatus readback mode
- Echo mode

The two stage readback consists of a write to a dedicated register, TWO_STAGE_READBACK_SELECT, to select the register location to be read back. This write is followed by a no operation (NOP) command, during which the contents of the selected register are available on SDO.

Table 13. SDO Contents for Read Operation

MSB				LSB
[D31:D30]	D29	[D28:24]	[D23:D8]	[D7:D0]
0b10	FAULT pin status	Register address	Data	CRC

Bits[D31:D30] = 0b10 are used for synchronization purposes during readback.

If autostatus readback mode is selected, the contents of the status register is available on the SDO line during every SPI transaction. This ability allows the user to continuously monitor the status register and act quickly in the case of a fault. The ADFS5758 powers up with this feature disabled. When this feature is enabled, the normal two-stage readback feature is not available. Only the status register is available on SDO. To read back any other register, disable the automatic readback feature first before following the two-stage readback sequence. The automatic status readback can be reenabled after the register is read back.

The shared SYNC autostatus readback is a special version of the autostatus readback mode used to avoid SDO bus contention when multiple devices are sharing the same SYNC line.

Echo mode behaves similarly to autostatus readback mode, except that every second readback consists of an echo of the previous command written to the ADFS5758 (see Figure 81). See the Reading from Registers section for further details on the readback modes.



Figure 81. SDO Contents, Echo Mode

WINDOWED WATCHDOG TIMER (WDT)

This watchdog timer feature is useful to ensure that communication has not been lost between the system controller and the ADFS5758 and that the SPI datapath lines are functioning as expected.

When enabled, the WDT alerts the system if the ADFS5758 does not receive a specific SPI frame in the user-programmable timeout period. A valid watchdog kick is a specific SPI frame received within the pass window of the WDT. When the specific SPI frame is received, the watchdog resets the timer controlling the timeout alert. The SPI frame used to reset the WDT is configurable as one of three choices:

- A valid SPI write to any register.
- A specific key code write to the key register (default).
- Two specific consecutive key code writes to the key register.

As shown in Figure 82, the watchdog timer uses a center threshold and a window width, where the width is a fraction of the center threshold. For example, if the center threshold is set to 100 ms and the window width set to 1/2, the valid region is 100 ms ± 25 ms. A WDT kick before 75 ms or after 125 ms is

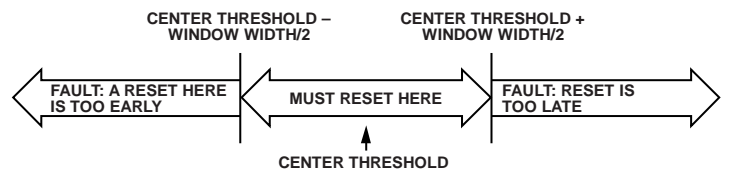

Figure 82. Windowed Watchdog Timer

registered as a fault. The windowing feature of the WDT can be disabled by setting the window width to 1/1. In this scenario, the user must simply kick the WDT any time before the center threshold, eliminating the possibility of an early reset and thus simplifying the operation of the WDT. For highest safety, the window feature requires that the user write the correct key (or two keys, if enabled) within the timeout window. If the signal arrives before or after this timing window, the watchdog times out and a dedicated WDT_STATUS bit in the status register alerts the user that the WDT has timed out. The DIGITAL_DIAG_RESULTS register can be read to clarify whether the WDT timeout was due to a late or early kick. Note that, when a WDT timeout occurs, all writes to the DAC_INPUT register as well as hardware or software LDAC events are ignored until the active WDT fault flag within the DIGITAL_DIAG_RESULTS register is cleared. Once this flag has been cleared the WDT can be restarted by performing a subsequent WDT kick command.

On power-up, the WDT is disabled by default. The default settings of the center threshold and window width are 1 sec and 1/1, respectively. The default method to kick the WDT is to write one specific key and, upon timeout, the default action is to set the relevant flag bits and the FAULT pin. See Table 41 for specific register bit details to support the configurability of the WDT operation.

USER DIGITAL OFFSET AND GAIN CONTROL

The ADFS5758 has a USER_GAIN and a USER_OFFSET register that allow trimming of the gain and offset errors from the entire signal chain. The 16-bit USER_GAIN register allows the user to adjust the gain of the DAC channel in steps of 1 LSB. The USER_GAIN register coding is straight binary, as shown in Table 14. The default code in the USER_GAIN register is 0xFFFF, which results in no gain factor applied to the programmed output. In theory, the gain can be tuned across the full range of the output. In practice, the maximum recommended gain trim is approximately 50% of the programmed range to maintain accuracy.

Table 14. Gain Register Adjustment

Gain Adjustment Factor	D15	D14 to D1	D0
1	1	1	1
65,535/65,536	1	1	0
...
2/65,536	0	0	1
1/65,536	0	0	0

The 16-bit USER_OFFSET register allows the user to adjust the offset of the DAC channel by $-32,768$ LSBs to $+32,768$ LSBs in steps of 1 LSB. The USER_OFFSET register coding is straight binary as shown in Table 15. The default code in the USER_OFFSET register is 0x8000, which results in zero offset programmed to the output.

Table 15. Offset Register Adjustment

Gain Adjustment	D15	D13 to D2	D0
+32,768 LSBs	1	1	1
+32,767 LSBs	1	1	0
...
No Adjustment (Default)	1	0	0
...
-32,767 LSBs	0	0	1
-32,768 LSBs	0	0	0

The value (in decimal) that is written to the internal DAC register can be calculated by

$$DAC_Code = D \times \frac{(M + 1)}{2^{16}} + C - 2^{15} \quad (1)$$

where:

D is the code loaded to the DAC_INPUT register.

M is the code in the USER_GAIN register (default code = $2^{16} - 1$).

C is the code in the USER_OFFSET register (default code = 2^{15}).

Data from the DAC_INPUT register is processed by a digital multiplier and adder, controlled by the contents of the user gain and USER_OFFSET registers, respectively. The calibrated DAC data is then loaded to the DAC, dependent on the state of the LDAC pin.

Each time data is written to the USER_GAIN or USER_OFFSET register, the DAC output is not automatically updated. Instead, the next write to the DAC_INPUT register uses these user gain and user offset values to perform a new calibration and automatically updates the channel. The read only DAC_OUTPUT register represents the value currently available at the DAC output except in the case of user gain and user offset calibration. In this case, the DAC_OUTPUT register represents the DAC data input by the user, on which the calibration was performed and not the result of the calibration.

Both the USER_GAIN register and the USER_OFFSET register have 16 bits of resolution. The correct method to calibrate the gain and offset is to first calibrate the gain and then calibrate the offset.

DAC OUTPUT UPDATE AND DATA INTEGRITY DIAGNOSTICS

Figure 83 shows a simplified version of the DAC input loading circuitry. If used, the USER_GAIN and USER_OFFSET registers must be updated before writing to the DAC_INPUT register.

The DAC_OUTPUT register (and ultimately the DAC output) updates in any of the following cases:

- If a write is performed to the DAC_INPUT register with the hardware LDAC pin tied low, the DAC_OUTPUT register is updated on the rising edge of SYNC (subject to the timing specifications in Table 2).
- If the hardware LDAC pin is high and a write to the DAC_INPUT register occurs, the DAC_OUTPUT register does not update until a software LDAC instruction is issued or the hardware LDAC pin is pulsed low.
- If a WDT timeout occurs with the CLEAR_ON_WDT_FAIL bit set, the CLEAR_CODE register contents are loaded to the DAC_OUTPUT register.
- If the slew rate control feature is enabled, the DAC_OUTPUT register contains the dynamic value of the DAC as it slews between values.

Note that, while a WDT fault is active, all writes to the DAC_INPUT register as well as hardware or software LDAC events are ignored. If the CLEAR_ON_WDT_FAIL bit was set, such that the output was set to the clear code, when the WDT fault flag is cleared, the DAC_INPUT register must be written to before an update to the DAC_OUTPUT register occurs, that is, performing a software or hardware LDAC only reloads the DAC with the clear code. As described in the Echo Mode section, after configuring the DAC range (via the DAC_CONFIG register), a write to the DAC_INPUT register must occur, even if the contents of the DAC_INPUT register are not changing from their current value.

Note also that the GP_CONFIG2 register contains a bit to enable a global software LDAC mode, whereby the ADFS5758 address bits of the SW_LDAC command are ignored, thus enabling multiple ADFS5758 devices to be simultaneously updated using a single SW_LDAC command. This is a useful feature if the hardware LDAC pin is not being used in a system containing multiple ADFS5758 devices.

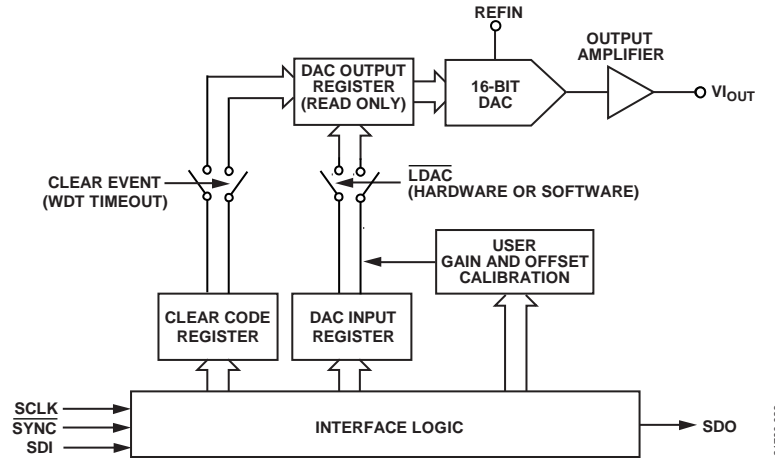

Figure 83. Simplified Serial Interface of Input Loading Circuitry

DAC Data Integrity Diagnostics

To protect against transient changes to the internal digital circuitry, the digital block stores both the digital DAC value and an inverted copy of the digital DAC value. A check is completed to ensure that the two values correspond to each other before the DAC is strobed to update to the DAC code. This feature is enabled by default (INVERSE_DAC_CHECK_EN bit in the DIGITAL_DIAG_CONFIG register).

Another optional diagnostic feature is the internal dual calibration feature. This feature is enabled by setting the DUAL_CAL_EN bit in the DIGITAL_DIAG_CONFIG register. When enabled, the internal calibration on the 16-bit user DAC code is completed twice. The DAC is only updated when both results match. If a fail is registered, no DAC write occurs and the DUAL_CAL_ERR flag is set.

Outside of the digital block, the DAC code is stored in latches (as shown in Figure 84). These latches are potentially vulnerable to the same transient events as those protected against within the digital block. To protect the DAC latches against such transients, the DAC latch monitor feature can be enabled via the DAC_LATCH_MON_EN bit within the DIGITAL_DIAG_CONFIG register. This feature monitors the actual digital code driving the DAC and compares it with the digital code generated within the digital block. Any difference between the two codes causes the DAC_LATCH_MON_ERR flag to be set in the DIGITAL_DIAG_RESULTS register.

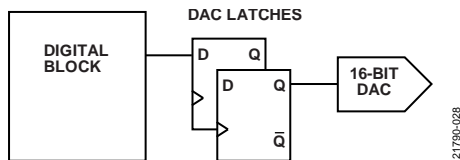

Figure 84. DAC Data Integrity

LOCKABLE USER CONFIGURATION SPACE

The ADFS5758 user configuration registers listed in Table 16 have the feature of being lockable as read only. This means that if locked, any writes to these registers are ignored and flagged in the DIGITAL_DIAG_RESULTS register via the CFG_LOCK_CHECK_ERR bit (if enabled) and via the FAULT pin.

Note that the V_{LDO} external capacitor detection feature must not be enabled prior to locking the configuration register space because this is a self clearing bit and causes the CFG_LOCK_CHECK_ERR bit to flag if the corresponding value changes subsequent to locking the configuration register space.

The user must write Data 0x4765 to the key register to lock the registers. To unlock the registers, two unlock keys must be written to the key register. The first key is Data 0x896D, and the second key is Data 0x57AB. The unlock keys must be written to the key register in that order.

The CFG_LOCK_CHECK_EN bit in the DIGITAL_DIAG_CONFIG register must be set to enable flagging of an attempt to write to a locked register via the CFG_LOCK_CHECK_ERR bit in the DIGITAL_DIAG_RESULTS register. If the CFG_LOCK_CHECK_EN bit is not set, the user has no indication that a write was attempted to the locked registers.

Table 16. Lockable Registers

Address	Register
0x03	CLEAR_CODE
0x04	USER_GAIN
0x05	USER_OFFSET
0x06	DAC_CONFIG
0x09	GP_CONFIG1
0x0A	GP_CONFIG2
0x0B	DCDC_CONFIG1
0x0C	DCDC_CONFIG2
0x0F	WDT_CONFIG
0x10	DIGITAL_DIAG_CONFIG
0x11	ADC_CONFIG
0x12	FAULT_PIN_CONFIG

USE OF KEY CODES

The use of key codes (via the key register) allows direct access to functions while keeping the user configuration register space locked as read only. This functionality is contained within one register and allows multiple commands (see the Key Register section for full details).

- Initiate calibration memory refresh
- Lock and unlock the user configuration register space.
- Initiate a software reset.
- Initiate a single ADC conversion.
- Watchdog timer reset keys.
- Recalculation of the background CRC diagnostic feature.

As well as enabling device access while the user configuration register space is locked, using specific keys for initiating actions such as a calibration memory refresh or a device reset provides extra system robustness because it reduces the probability of either of these tasks being initiated in error.

SOFTWARE RESET

A software reset requires two consecutive writes of 0x15FA and 0xAF51 to the key register. A device reset can be initiated via the hardware $\overline{\text{RESET}}$ pin, the software reset keys, or automatically after a WDT timeout (if configured to do so). The `RESET_OCCURRED` bit in the `DIGITAL_DIAG_RESULTS` register is set whenever the device is reset. This bit defaults to 1 on power-up. Both of the diagnostic results registers implement a write 1 to clear feature. That is, a 1 must be written to this bit to clear it (see the Sticky Diagnostic Results Bits section).

CALIBRATION MEMORY CRC

For every calibration memory refresh cycle (which is initiated via a key code write to the key register or automatically initiated when the range bits, Bits[3:0] of the `DAC_CONFIG` register, are changed), an automatic CRC is calculated on the contents of the calibration memory shadow registers. The result of this CRC is compared with the factory stored reference CRC value. If the CRC values match, the read of the entire calibration memory is considered valid. If they do not match, the `CAL_MEM_CRC_ERR` bit in the `DIGITAL_DIAG_RESULTS` register is set to 1. This feature is enabled by default and can be disabled via the `CAL_MEM_CRC_EN` bit in the `DIGITAL_DIAG_CONFIG` register.

While this calibration memory refresh cycle is active, two-stage readback commands are permitted, but a write to any register (other than the `TWO_STAGE_READBACK_SELECT` register or the `NOP` register) causes the `INVALID_SPI_ACCESS_ERR` bit in the `DIGITAL_DIAG_RESULTS` register to set. As described in the Echo Mode section, a wait period of 500 μs is recommended after a calibration memory refresh cycle is initiated.

BACKGROUND CRC CHECK

After the device powers up, it is possible for the user to initiate a background CRC calculation of the combined calibration memory and register configuration space. Note that such a background CRC calculation is enabled only when the configuration space is locked. Any attempt to initiate a CRC calculation when the configuration space is unlocked is ignored. When the configuration space is locked (see the Lockable User Configuration Space section), a CRC is automatically calculated in the background and stored as the ideal CRC value that all subsequent background CRC calculations are compared to. The background CRC calculation takes approximately 6 μs to complete.

A CRC check is configured by setting the relevant bits in the `DIGITAL_DIAG_CONFIG` register. There are three approaches to enable such a CRC check, as follows:

- Initiate a CRC recalculation upon issuing a specific key (default).
- Enable an autocheck of the CRC to be performed on completion of any valid SPI frame.
- Enable continuous monitor mode to continually recalculate the CRC in the background when enabled.

INTERNAL OSCILLATOR DIAGNOSTICS

An internal frequency monitor uses the internal oscillator (`MCLK`) to increment a 16-bit counter at a rate of 1 kHz (`MCLK/10,000`). The value of the counter is available to be read in the `FREQ_MONITOR` register. The user can poll this register periodically and use it both as a diagnostic tool for the internal oscillator (to monitor that the oscillator is running), and to measure the frequency. This feature is enabled by default via the `FREQ_MON_EN` bit in the `DIGITAL_DIAG_CONFIG` register.

In the event that the internal `MCLK` oscillator stops, the ADFS5758 sends a specific code of 0x07DEAD to the `SDO` line for every SPI frame. This feature is enabled by default and can be disabled by clearing the `OSC_STOP_DETECT_EN` bit in the `GP_CONFIG1` register. Note that this feature is limited to the maximum readback timing specifications as outlined in Table 3.

VLDO EXTERNAL CAPACITOR DETECTION

The GP_CONFIG2 register contains the VLDO_CAP_DETECT_EN bit that enables a diagnostic check to detect the presence of an external capacitor of 0.1 μF or larger on the VLDO pin (for example, the output of the internal 3.3 V VLDO). This check is a one-shot test that temporarily sets the VLDO output to a target voltage of 2.7 V. The time it takes to reach the target voltage determines the presence, or not, of an external capacitor. If there is no capacitor present, the VLDO_CAP_ERR bit is triggered in the ANALOG_DIAG_RESULTS register. It is recommended that no other instruction be written to the ADFS5758 for the duration of this test (approximately 100 μs). The VLDO_CAP_DETECT_EN bit remains high for the duration of the test and returns to 0 after the test completes and the VLDO node returns to the nominal value of 3.3 V.

STICKY DIAGNOSTIC RESULTS BITS

The ADFS5758 contains two diagnostic results registers: digital and analog (see Table 46 and Table 47, respectively). The diagnostic result bits contained within these registers are sticky (R/W-1-C), that is, each bit needs a 1 to be written to it to clear it. A more appropriate word here is update rather than clear because if the fault is still present, even after writing a 1 to the bit in question, it does not clear to 0. Upon writing Logic 1 to the bit, it updates to its latest value, which is Logic 1 if the fault is still present, and Logic 0 if the fault is no longer present.

There are two exceptions to this R/W-1-C access within the DIGITAL_DIAG_RESULTS register: CAL_MEMORY_UNREFRESHED and SLEW_BUSY. These flags automatically clear when the calibration memory refresh or output slew respectively, is complete.

The status register contains a DIG_DIAG_STATUS and ANA_DIAG_STATUS bit, which is the result of a logical OR of the diagnostic results bits contained in each of the diagnostic results registers. All analog diagnostic flag bits are included in the logical OR of the ANA_DIAG_STATUS bit and all digital diagnostic flag bits, with the exception of the SLEW_BUSY bit, are included in the logical OR of the DIG_DIAG_STATUS bit. The OR'ed bits within the status register are read-only and not sticky (R/W-1-C).

BACKGROUND SUPPLY AND TEMPERATURE MONITORING

Excessive die temperature and overvoltage are known to be related to common cause failures, and can be monitored in a continuous fashion using comparators, eliminating the requirement to poll the ADC.

Both die have a built-in temperature sensor with an accuracy of typically $\pm 5^\circ\text{C}$. The die temperature is monitored by a comparator. The background temperature comparators are permanently enabled. Programmable trip points corresponding to 142°C, 127°C, 112°C, and 97°C can be configured in the GP_CONFIG1 register. If the temperature of either die exceeds the programmed limit, the relevant status bit in the

ANALOG_DIAG_RESULTS register is set and the $\overline{\text{FAULT}}$ pin is asserted low. The ADFS5758 is designed and characterized to ensure that the ADFS5758 remains functional at the lowest overtemperature indicator trip point.

The low voltage supplies on the ADFS5758 are monitored via low power static comparators. This function is disabled by default and can be enabled via the COMPARATOR_CONFIG bits in the GP_CONFIG2 register. Note that the INT_EN bit in the DAC_CONFIG register must be set for the REFIN buffer to be powered up and this node available to the REFIN comparator. The monitored nodes are REFIN, REFOUT, VLDO, and an internal AV_{CC} voltage node (INT_AVCC). There is a status bits in the ANALOG_DIAG_RESULTS register corresponding to each monitored node. If any of the supplies exceed their upper or lower threshold values (Table 17), the corresponding status bit is set. Note that in the case of a REFOUT fault, the REFOUT_ERR status bit is set. In this case, the INT_AVCC, VLDO and temperature comparator status bits may also become set because REFOUT is used as the comparison voltage for these nodes. As per all other status bits in the ANALOG_DIAG_RESULTS register, these bits are sticky and need a 1 to be written to them to clear them; assuming, of course, the error condition has subsided. If the error condition is still present, the flag remains high even after a 1 has been written to clear it.

Table 17. Comparator Supply Activation Thresholds

Supply	Lower Threshold (V)	Nominal Value/Range (V)	Upper Threshold (V)
INT_AVCC	3.8	4 to 5	5.2
VLDO	2.8	3 to 3.6	3.8
REFIN	2.24	2.5	2.83
REFOUT	2.24	2.5	2.83

OUTPUT FAULT

The ADFS5758 is equipped with a $\overline{\text{FAULT}}$ pin. This pin is an active low, open-drain output allowing several ADFS5758 devices to be connected together to one pull-up resistor for global fault detection. This pin is high impedance when no faults are detected and is asserted low when certain faults are detected, for example, an open circuit in current mode, a short circuit in voltage mode, a CRC error, or an overtemperature error. Table 18 shows the fault conditions that automatically force the $\overline{\text{FAULT}}$ pin active and highlights the user maskable fault bits available via the FAULT_PIN_CONFIG register (see Table 44). Note that all registers contain a corresponding $\overline{\text{FAULT}}$ pin status bit (FAULT_PIN_STATUS) that mirrors the inverted current state of the $\overline{\text{FAULT}}$ pin. For example, if the $\overline{\text{FAULT}}$ pin is active, then the FAULT_PIN_STATUS bit is 1.

Table 18. FAULT Pin Trigger Sources

Fault Type	Mapped to FAULT Pin	Mask Ability
Digital Diagnostic Faults		
Oscillator Stop Detect	Yes	Yes
Calibration Memory Not Refreshed	No	N/A ¹
Reset Detected	No	N/A ¹
3-Wire Interface Error	Yes	No
WDT Late Error	Yes	Yes
WDT Early Error	Yes	Yes
Background CRC Error	Yes	No
DAC Latch Monitor Error	Yes	Yes
Dual Calculation Error	Yes	Yes
Inverse DAC Check Error	Yes	Yes
Calibration Memory CRC Error	Yes	No
Invalid SPI Access	Yes	Yes
Write Attempted on Locked Configuration Register Space	Yes	Yes
SCLK Count Error	Yes	No ²
Slip Bit Error	Yes	Yes
SPI CRC Error	Yes	Yes
Analog Diagnostic Faults		
V _{OUT} Overvoltage Error	Yes	Yes
DC-to-DC Short Circuit Error	Yes	Yes
DC-to-DC Power Error	Yes	No
V _{LDO} Capacitor Detection	No	N/A ¹
Current Output Open Circuit Error	Yes	Yes
Voltage Output Short-Circuit Error	Yes	Yes
DC-to-DC Die Temperature Error	Yes	Yes
Main Die Temperature Error	Yes	Yes
REFOUT Comparator Error	Yes	No
REFIN Comparator Error	Yes	No
INT_AVCC Comparator Error	Yes	No
V _{LDO} Comparator Error	Yes	No

¹ N/A means not applicable.

² Although the SCLK count error cannot be masked in the FAULT_PIN_CONFIG register, it can be excluded from the FAULT pin by enabling the SPI_DIAG_QUIET_EN bit (Bit 3 in the GP_CONFIG1 register).

The DIG_DIAG_STATUS, ANA_DIAG_STATUS, and WDT_STATUS bits of the status register are used in conjunction with the FAULT pin and the FAULT_PIN_STATUS bit to inform the user which one of the fault conditions caused the FAULT pin or FAULT_PIN_STATUS bit to be activated.

ADC MONITORING

The ADFS5758 incorporates a 12-bit ADC to provide diagnostic information on user-selectable inputs such as supplies, grounds, internal die temperatures, references, and external signals (via the ADC1 pin). A full list of the selectable inputs are available in Table 19. The reference used for the ADC is derived from REFOUT. This provides a means of having independence from the DAC reference (REFIN) if necessary. The ADC_CONFIG register configures the mode of operation of the ADC (user initiated individual conversions or sequence mode) as well as selection of the multiplexed ADC input channel via the ADC_IP_SELECT bits (see Table 43).

ADC Transfer Function Equations

The ADC has an input range of 0 V to 2.5 V and can be used to digitize a variety of different nodes. The set of inputs to the ADC encompasses both unipolar and bipolar ranges, varying from high to low voltage values. Therefore, to be able to digitize them, the voltage ranges outside of the 0 V to 2.5 V ADC input range must be divided down. The ADC transfer function equation is dependent on the selected ADC input node (see Table 19 for a summary of all transfer function equations).

ADC1 Pin Input

Figure 85 shows the ADC1 pin can be used to monitor the I_{OUT} return current from the output load. If a 20 Ω external sense resistor is used, an I_{OUT} programmed current of 24 mA becomes 480 mV across R_{SENSE}.

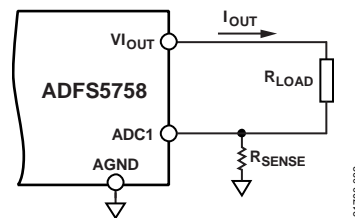

Figure 85. I_{OUT} Monitoring via ADC1 Pin

Summary of ADC Input Nodes

Table 19 is a summary of all possible nodes that can be digitized by the ADC and the corresponding transfer function equations.

Recommended R_{SENSE}

Analog Devices recommends a low drift, high accuracy resistor. The R_{SENSE} performance depends on the absolute value and temperature coefficient of the resistor used. The resistor specifications, therefore, directly affect the overall ADC error budget.

Table 19. ADC Input Node Summary

ADC_IP_SELECT	V _{IN} Node Description	ADC Transfer Function ¹
00000	Main die temperature	$T (^{\circ}\text{C}) = (-0.09369 \times D) + 307$
00001	DC-to-dc die temperature	$T (^{\circ}\text{C}) = (-0.11944 \times D) + 436$
00010	Reserved	Reserved
00011	REFIN	$\text{REFIN (V)} = (D/2^{12}) \times 2.75$
00100	Internal 1.23 V reference voltage (REF2).	$\text{REF2 (V)} = (D/2^{12}) \times 2.5$
00101	Reserved	Reserved
00110	Reserved	Reserved
01100	ADC2 pin input	$\text{ADC2 (V)} = (30 \times D)/2^{12} - 15$
01101	Voltage on +V _{SENSE} buffer output	$+V_{\text{SENSE}} (\text{V}) = ((50 \times D)/2^{12}) - 25$
01110	Voltage on -V _{SENSE} buffer output	$-V_{\text{SENSE}} (\text{V}) = ((50 \times D)/2^{12}) - 25$
01111	ADC1 pin input (0 V to 1.25 V input range)	$\text{ADC1 (V)} = D/2^{12} \times 1.25$
10000	ADC1 pin input (0 V to 0.5 V input range)	$\text{ADC1 (V)} = D/2^{12} \times 2.5 \times 1/5 = D/2^{12} \times 0.5$
10001	ADC1 pin input (0 V to 2.5 V input range)	$\text{ADC1 (V)} = D/2^{12} \times 2.5$
10010	ADC1 pin input (± 0.5 V input range)	$\text{ADC1 (V)} = D/2^{12} - 0.5$
10011	Reserved	Reserved
10100	INT_AVCC	$\text{INT_AVCC (V)} = D/2^{12} \times 10$
10101	V _{LDO}	$V_{\text{LDO}} (\text{V}) = D/2^{12} \times 10$
10110	V _{LOGIC}	$V_{\text{LOGIC}} (\text{V}) = D/2^{12} \times 10$
11000	REFGND	$\text{REFGND (V)} = D/2^{12} \times 2.5$
11001	AGND	$\text{AGND (V)} = D/2^{12} \times 2.5$
11010	DGND	$\text{DGND (V)} = D/2^{12} \times 2.5$
11011	V _{DPC+}	$V_{\text{DPC}} (\text{V}) = D/2^{12} \times 37.5$
11100	AV _{DD2}	$\text{AV}_{\text{DD2}} (\text{V}) = D/2^{12} \times 37.5$
11101	AV _{SS}	$\text{AV}_{\text{SS}} (\text{V}) = (15 \times D/2^{12} - 14) \times 2.5$
11110	DC-to-dc die node, configured in the DCDC_CONFIG2 register 00: AGND on dc-to-dc die 01: internal 2.5 V supply on dc-to-dc die 10: AV _{DD1} 11: reserved	$\text{AGND (dc-to-dc) (V)} = (D/2^{12}) \times 2.5$ $\text{Internal 2.5 V (dc-to-dc) (V)} = (D/2^{12}) \times 5$ $\text{AV}_{\text{DD1}} (\text{V}) = D/2^{12} \times 37.5$
11111	REFOUT	$\text{REFOUT (V)} = (D/2^{12}) \times 2.5$

¹ D refers to ADC data.

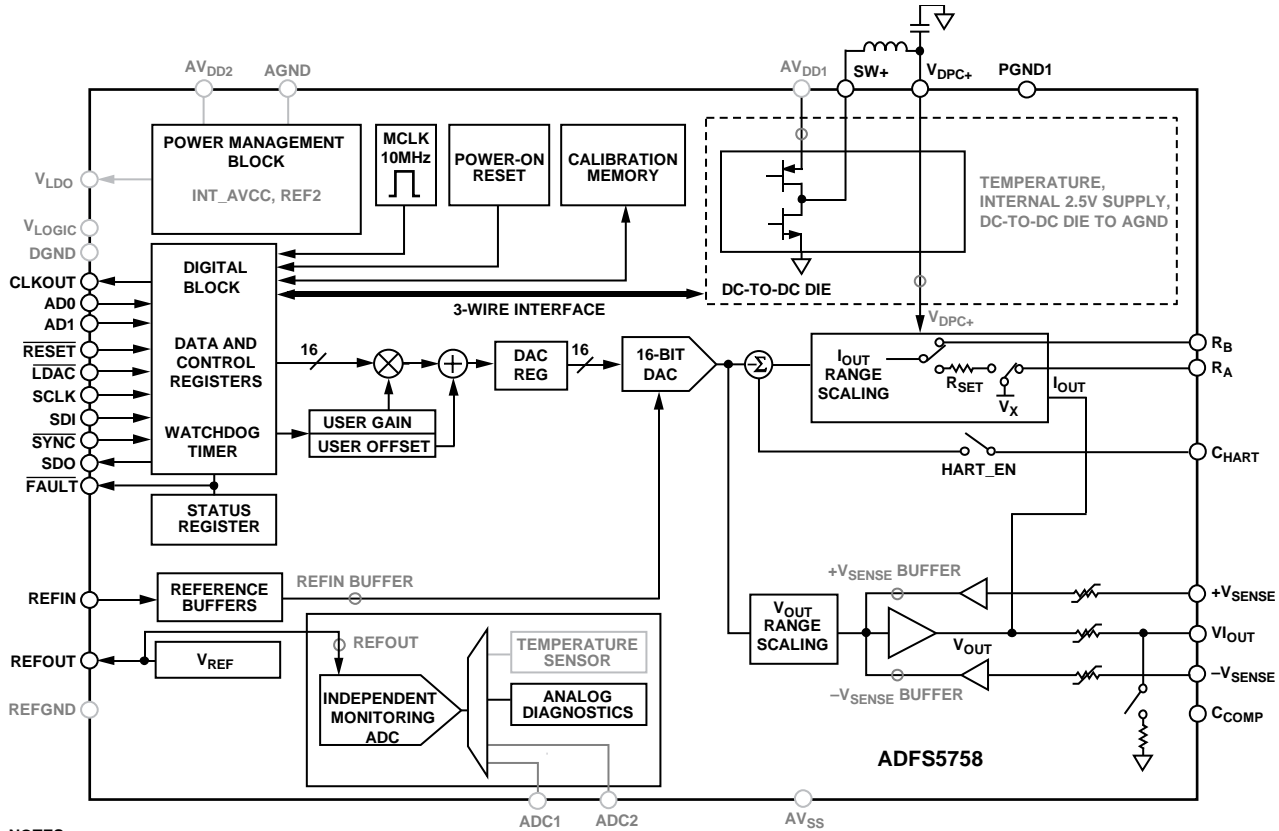

NOTES
1. GRAY ITEMS REPRESENT DIAGNOSTIC ADC INPUT NODES.

Figure 86. Diagnostic ADC Input Nodes

ADC Accuracy Calculations

The ADC accuracy is dependent on the input node being converted.

If the ADC1 pin is used to monitor the I_{OUT} return current (see Figure 85), the overall ADC conversion accuracy can be calculated by summing the following components:

- ADC accuracy for the ADC1 pin input node.
- Accuracy of external R_{SENSE} resistor.
- TC of the external R_{SENSE} resistor.

ADC Configuration

The ADC is configured using the ADC_CONFIG register via the SEQUENCE_COMMAND (Bits[10:8]), the SEQUENCE_DATA (Bits[7:5]), and the ADC_IP_SELECT[4:0] bits.

Table 20. ADC Configuration Register

[D10:D8]	[D7:D5]	[D4:D0]
Command	Data	ADC input select

The ADC can be set up to monitor a single node of interest or configured to sequence through up to eight nodes of interest. The sequential conversions can be initiated automatically after each valid SPI frame is received by the device (automatic sequence mode), or in a more controlled manner via a specific key code written to the key register (key sequence mode). When a conversion is complete, the ADC result is available in the status register and, if in sequence mode, the sequencer address is

advanced. If autostatus readback mode is used in conjunction with either sequence mode, the last completed ADC conversion data is available on SDO during each SPI frame written to the device.

The sequencer has a maximum channel depth of 8. Each of the channels in the sequencer must be configured with the select bits of the required ADC input for that sequencer channel, and the number of configured channels must equal the depth. If any active sequencer channel location is not configured correctly, it stores the previous value loaded to that channel, defaulting initially to the ADC input option of 0b00000 for all sequencer channels. Note that, if a node from the dc-to-dc die is required to be part of the ADC sequencer, preconfigure this node using the DCDC_ADC_CONTROL_DIAG bits in the DCDC_CONFIG2 register before configuring the ADC sequencer to avoid any 3WI related delays between ADC conversions. If multiple nodes from the dc-to-dc die are required within the sequence, key sequencing mode must be used rather than automatic sequencing mode, because the DCDC_ADC_CONTROL_DIAG bits must be updated between ADC conversions to configure the next required dc-to-dc die node required by the sequence.

The four modes of operation are key sequencing, automatic sequencing, single immediate conversion, and single-key conversion. The sequencing modes are mutually exclusive. If enabled, the key sequencing mode disables the automatic sequencing mode and vice versa.

Key Sequencing (Command 010)

Writing Command 010 enables key sequencing mode. Sequencing starts with a write to the key register with Key Code 0x1ADC, starting on Channel 0 and continuing to Channel N – 1, where N is the depth, with each 0x1ADC command. This mode enables user control of the switching of channels during sequencing because the switch occurs only for each specific key code command, rather than for each valid SPI frame, as in the case of automatic sequencing mode. When the sequence is completed, it starts again with Channel 0 until disabled. Command 000 and Command 001 must be used to configure all the required channels before Command 0b010 is issued to enable key sequencing mode (see Figure 87). If the sequencing is disabled and later reenabled, the sequencer is reset to recommence converting on the first channel in the sequence.

Automatic Sequencing (Command 011)

Sequencing starts on the next valid SPI frame, starting with Channel 0 and continuing to Channel N – 1, where N is the depth, on each valid SPI frame. When the sequence is complete, it starts again with Channel 0 until disabled. As with the key sequencing mode, Command 000 and Command 001 must be used to configure all the required channels before Command 011 is issued to enable automatic sequencing mode (see Figure 87). If the sequencing is disabled and later reenabled, the sequencer is reset to recommence converting on the first channel in the sequence. When reenabled, the channels do not need to be reconfigured, unless the desired list of nodes changes.

Single Immediate Conversion (Command 100)

This mode initiates a single conversion on the node currently selected in the ADC input select bits of the ADC_CONFIG register. Selecting this command stops any active automatic sequence, meaning that it must be reenabled if required. The sequencer does not need to be reconfigured because the configuration of sequencer depth and channels is stored.

Single Key Conversion (Command 101)

This mode is used to set up an individual ADC input node to be converted at some future time, initiated by writing the 0x1ADC key code to the key register. This mode is useful if the user configuration space is locked and an ADC conversion is required without unlocking the user configuration space.

Sequencing Mode Setup

A list of the relevant ADC sequencer commands is shown in Table 21. These commands are available in the ADC_CONFIG register (see Table 43 for the ADC_CONFIG register bits). The default depth (000) is equivalent to one diagnostic channel up to a binary depth value of 111, which is equivalent to eight channels.

Three steps are involved in setting up the sequencer:

1. Select the depth.
2. Load the channels into the sequencer N times for N channels.
3. Enable the sequencer.

An example of configuring the sequencer to monitor three ADC nodes is shown in Figure 87.

Table 21. Command Bits

Value	Description
000	Set the sequencer depth (0 to 7)
001	Load sequencer Channel N with the selected ADC input
010	Enable or disable the key sequencer
011	Enable or disable the automatic sequencer
100	Perform a single conversion on the currently selected ADC input (D4 to D0)
101	Set up single key conversion, that is, select the ADC mux input to be used when triggered with a write to the key register (this is outside of the key sequencing mode)

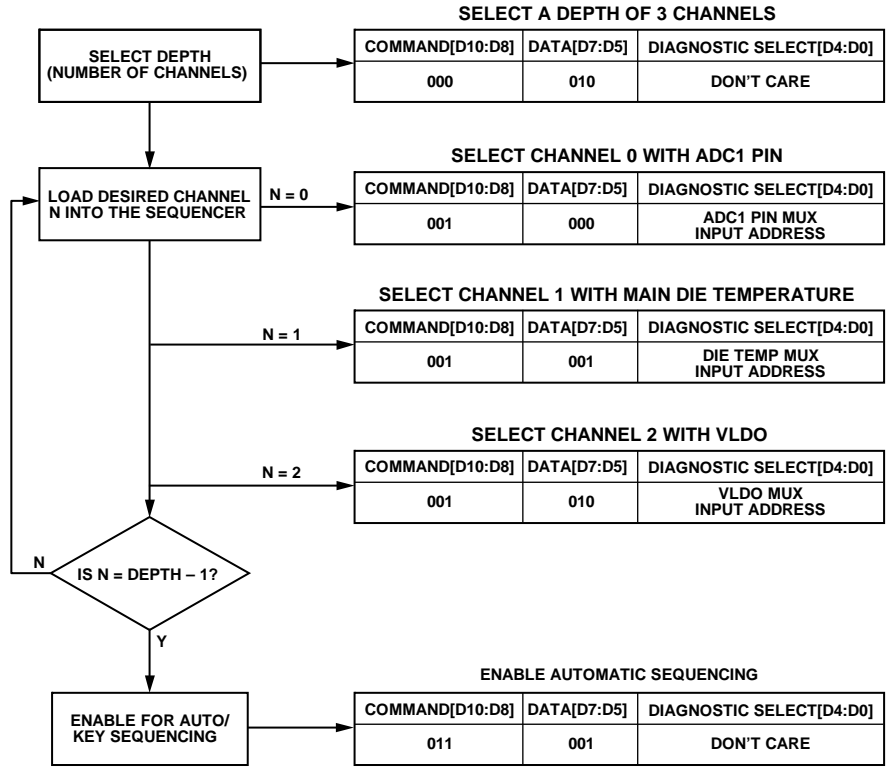

Figure 87. Example Automatic Sequence Mode Setup for Three ADC Input Nodes

ADC Conversion Timing

Figure 88 shows an example where autostatus readback mode is enabled. The status register always contains the last completed ADC conversion result, together with the associated mux address, ADC_IP_SELECT.

This example is applicable irrespective of the ADC conversion mode in use (key sequencing, automatic sequencing, single immediate conversion, or single key conversion). During the first ADC conversion command shown, the contents of the status register are available on the SDO line. The ADC portion of this data contains the conversion result of the previously

converted ADC node (ADC Conversion Result 0), as well as the associated channel address. Assuming another SPI frame is not received while the ADC is busy converting due to Command 1, then the next data to appear on the SDO line contains the associated conversion result, ADC Conversion Result 1. If, however, an SPI frame is received while the ADC is busy, the status register contents available on SDO still contains the previous conversion result and indicates the ADC_BUSY flag is high. Any new ADC conversion instructions received while the ADC_BUSY bit is active are ignored. If using a sequencer mode, the sequencer address is updated after the conversion is complete.

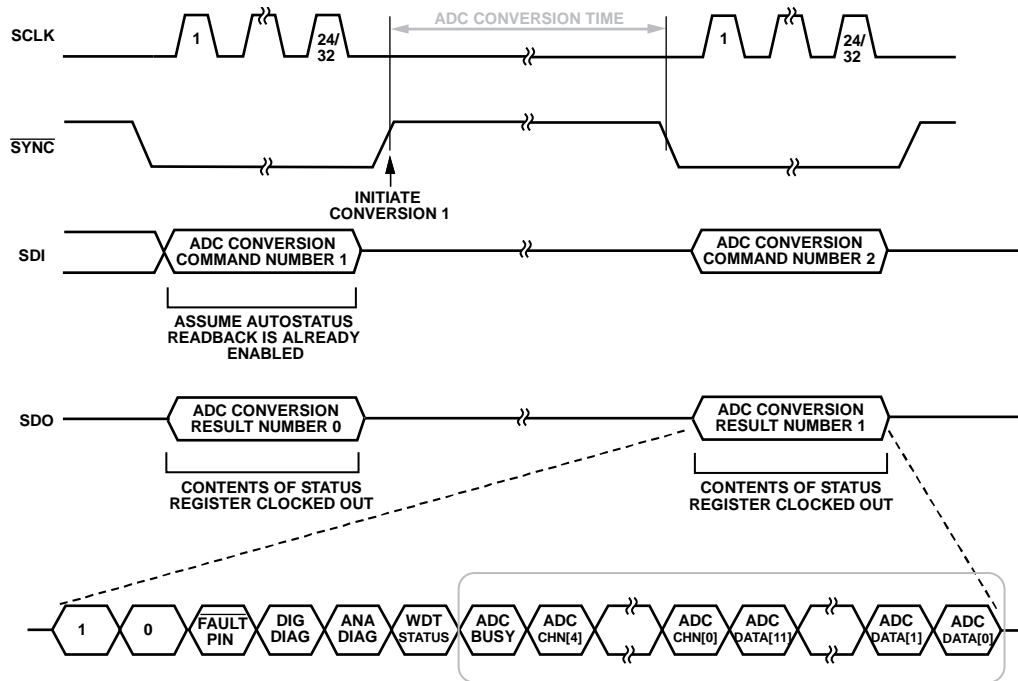

NOTES
 1. STATUS REGISTER CONTENTS CONTAINING ADC CONVERSION RESULT, CORRESPONDING ADDRESS, AND ADC BUSY INDICATOR.

Figure 88. ADC Conversion Timing Example

21790-034

REGISTER MAP

The ADFS5758 is controlled and configured via on-chip registers described in the Register Details section. The four possible access permissions are

- R/W: read/write
- R: read only
- R/W-1-C: read/write 1 to clear
- R0/W: read zero/write

Reading from and writing to reserved registers is flagged as an invalid SPI access (see Table 46). When accessing registers with reserved bit fields, the default value of those bit fields must be written. These values are listed under the Reset column of Table 28 to Table 54.

WRITING TO REGISTERS

When writing to any register, the format in Table 22 is used. By default, the SPI CRC is enabled and the input register is 32 bits wide, with the last eight bits corresponding to the CRC code. Only frames of exactly 32 bits wide are accepted as valid. If CRC is disabled, the input register is 24 bits wide. 32-bit frames are also accepted in this case with the final eight bits ignored. Table 23 describes the function of Bit D23 to Bit D16. Bit D15 to Bit D0 depend on the register that is being addressed.

Table 22. Writing to a Register

MSB								LSB
D23	D22	D21	D20	D19	D18	D17	D16	D15 to D0
ADFS5758_AD1	ADFS5758_AD1	ADFS5758_AD0	REG_ADR4	REG_ADR3	REG_ADR2	REG_ADR1	REG_ADR0	Data

Table 23. Input Register Decode

Bit	Description
ADFS5758_AD1	Slip bit. This bit must equal the inverse of Bit D22 (that is, ADFS5758_AD1).
ADFS5758_AD1, ADFS5758_AD0	Used in association with the external pins (AD1 and AD0) to determine which ADFS5758 device is being addressed by the system controller. Up to 4 unique devices can be addressed, corresponding to the ADFS5758_AD1 and ADFS5758_AD0 addresses of 00, 01, 10, and 11.
REG_ADR4, REG_ADR3, REG_ADR2, REG_ADR1, REG_ADR0	Selects which register is written to. See Table 27 for a summary of the available registers.

READING FROM REGISTERS

The ADFS5758 has four options for readback mode that can be configured in the TWO_STAGE_READBACK_SELECT register (see Table 45):

- Two-stage readback
- Autostatus readback
- Shared SYNC autostatus readback
- Echo mode

Two-Stage Readback Mode

Two-stage readback mode consists of a write to the TWO_STAGE_READBACK_SELECT register to select the register location to be read back, followed by a NOP command. To perform a NOP command, write all zeros to Bits[D15:D0] of the NOP register. During the NOP command, the contents of the selected register are available on SDO in the format shown in Table 24. It is also possible to write a new two-stage readback command during the second frame such that the corresponding new data is available on SDO in the subsequent frame (see Figure 89). Bits[D31:D30] (or Bits[D23:D22], if SPI CRC is not enabled) = 10 are used as part of the synchronization during readback. The contents of the first write instruction (to the TWO_STAGE_READBACK_SELECT register) is shown in Table 25.

Table 24. SDO Contents for Read Operation

MSB		LSB	
D23 to D22	D21	D20 to D16	D15 to D0
10	FAULT pin status	Register address	Data

Table 25. Reading from a Register (Using Two-Stage Readback Mode)

MSB										LSB				
D23	D22	D21	D20	D19	D18	D17	D16	D15 to D5		D4	D3	D2	D1	D0
ADFS5758_AD1	ADFS5758_AD1	ADFS5758_AD0	0x13				Reserved		READBACK_SELECT[4:0]					

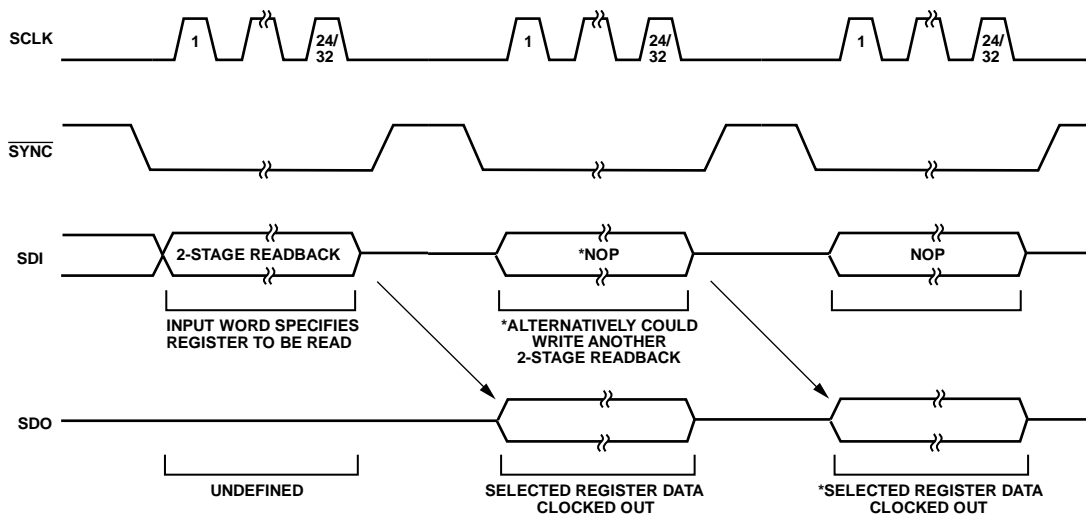

Figure 89. Two-Stage Readback Example

21790-037

Autostatus Readback Mode

If autostatus readback mode is selected, the contents of the status register is available on the SDO line during every SPI transaction. When reading back the status register, the SDO contents differ from the format shown in Table 24. The

contents of the status register is shown in Table 26. The autostatus readback mode can be used in conjunction with the ADC sequencer to consecutively monitor up to eight different ADC inputs. See the ADC Monitoring section for further details on the ADC sequencer.

Table 26. SDO Contents for a Read Operation in the Status Register

MSB								LSB	
D23	D22	D21	D20	D19	D18	D17	D16 to D12	D11 to D0	
1	0	FAULT_PIN_STATUS	DIG_DIAG_STATUS	ANA_DIAG_STATUS	WDT_STATUS	ADC_BUSY	ADC_CH[4:0]	ADC_DATA[11:0]	

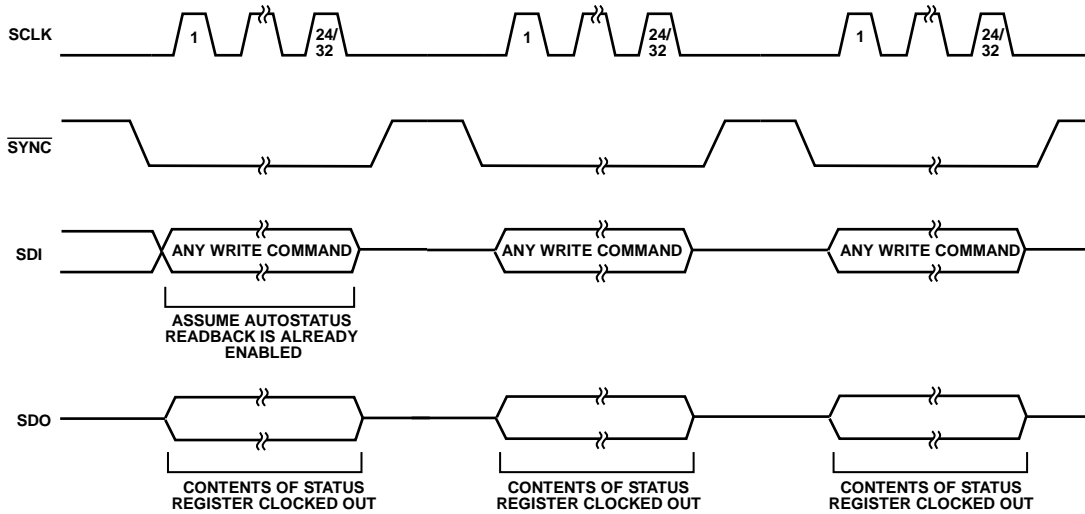

Figure 90. Autostatus Readback Example

217790-038

Shared/ $\overline{\text{SYNC}}$ Autostatus Readback Mode

The shared $\overline{\text{SYNC}}$ autostatus readback is a special version of the autostatus readback mode used to avoid SDO bus contention when multiple ADFS5758 devices are sharing the same $\overline{\text{SYNC}}$ line (whereby ADFS5758 devices are distinguished from each other using the hardware address pins). After each valid write to a device, a flag is set. On the subsequent falling edge of $\overline{\text{SYNC}}$, the flag is cleared. This mode behaves in a similar manner to the normal autostatus readback mode, except that

the device does not output the status register contents on SDO as $\overline{\text{SYNC}}$ goes low, unless the internal flag is set (that is, the previous SPI write was valid). See the example shown in Figure 91.

Echo Mode

Echo mode behaves in a similar manner to the autostatus readback mode, except that every second readback consists of an echo of the previous command written to the ADFS5758. This echo mode is useful to check which SPI instruction was received in the previous SPI frame.

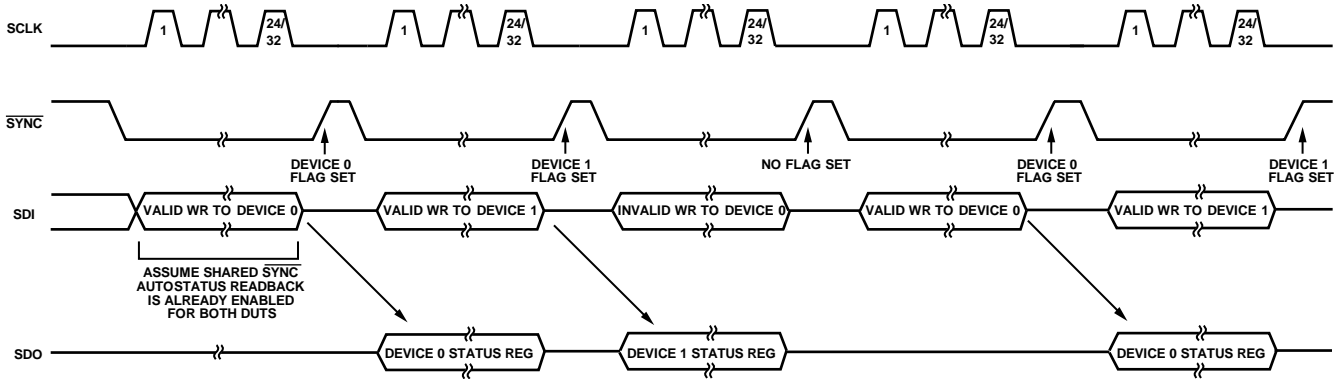

Figure 91. Shared/ $\overline{\text{SYNC}}$ Autostatus Readback Example



Figure 92. SDO Contents—Echo Mode

PROGRAMMING SEQUENCE TO ENABLE THE OUTPUT CORRECTLY

To correctly write to and set up the device from a power-on or reset condition, use the following sequence:

1. Perform a hardware or software reset and wait 100 μ s.
2. Perform a calibration memory refresh by writing 0xFCBA to the key register. Wait a minimum of 500 μ s before proceeding to Step 3 to allow time for the internal calibrations to complete. As an alternative to waiting 500 μ s for the refresh cycle to complete, poll the CAL_MEM_UNREFRESHED bit in the DIGITAL_DIAG_RESULTS register until it is 0.
3. Write 1 to Bit D13 in the DIGITAL_DIAG_RESULTS register to clear the RESET_OCCURRED flag.
4. If CLKOUT is required, configure and enable this feature via the GP_CONFIG1 register. It is important to configure this feature before enabling the dc-to-dc converter.
5. Write to the DCDC_CONFIG2 register to set the dc-to-dc current limit. Wait 300 μ s to allow the 3-wire interface communication to complete. As an alternative to waiting 300 μ s for the 3-wire interface communication to complete, poll the BUSY_3WI bit in the DCDC_CONFIG2 register until it is 0.
6. Write to the DCDC_CONFIG1 register to set up the dc-to-dc converter mode (thereby enabling the dc-to-dc converter). Wait 300 μ s to allow the 3-wire interface communication to complete. As an alternative to waiting 300 μ s to the 3-wire interface communication to complete, poll the BUSY_3WI bit in the DCDC_CONFIG2 register until it is 0.
7. Write to the DAC_CONFIG register to set the INT_EN bit (powers up the DAC and internal (INT) amplifiers without enabling the output) and configure the output range, internal/external R_{SET} , and slew rate. Keep the OUT_EN bit disabled at this point. Wait 500 μ s minimum before proceeding to Step 8 to allow time for the internal calibrations to complete. As an alternative to waiting 500 μ s for the refresh cycle to complete, poll the CAL_MEM_UNREFRESHED bit in the DIGITAL_DIAG_RESULTS register until it is 0.
8. Write zero-scale DAC code to the DAC_INPUT register. If a bipolar range was selected in Step 7, a DAC code that

represents a 0 mA/0 V output must be written to the DAC_INPUT register. It is important that this step be completed even if the contents of the DAC_INPUT register are not changing.

9. If LDAC functionality is being used, perform either a software or hardware LDAC command.
10. Enable the background supply monitoring voltage comparators.
11. Rewrite the same word to the DAC_CONFIG register as in Step 7 except, this time, with the OUT_EN bit enabled. Allow 1.25 ms minimum between Step 6 and Step 11; this is the time from when the dc-to-dc is enabled to when the V_{IOUT} output is enabled.
12. Write the required DAC code to the DAC_INPUT register.
13. Write 0x4765 to the key register to lock the user configuration register space. This is an optional step.

An example configuration is shown in Figure 93. Additional configuration and diagnostics including ADC configuration must be configured before Step 13.

Changing and Reprogramming the Range

After the output is enabled, use the following recommended steps when changing the output range. If the user configuration register space is locked, it must first be unlocked by writing to the key register before Step 2 can be performed. It can be relocked, if required, after Step 4.

1. Write to the DAC_INPUT register. Set the output to 0 mA or 0 V.
2. Write to the DAC_CONFIG register. Disable the output ($OUT_EN = 0$), and set the new output range. Keep the INT_EN bit set. Wait 500 μ s minimum before proceeding to Step 3 to allow time for internal calibrations to complete.
3. Write Code 0x0000 (in the case of bipolar ranges write Code 0x8000) to the DAC_INPUT register. It is important that this step be completed even if the contents of the DAC_INPUT register are not changing.
4. Reload the DAC_CONFIG register word from Step 2 except, this time, set the OUT_EN bit to 1 to enable the output.
5. Write the required DAC code to the DAC_INPUT register.

EXAMPLE CONFIGURATION TO ENABLE THE OUTPUT CORRECTLY

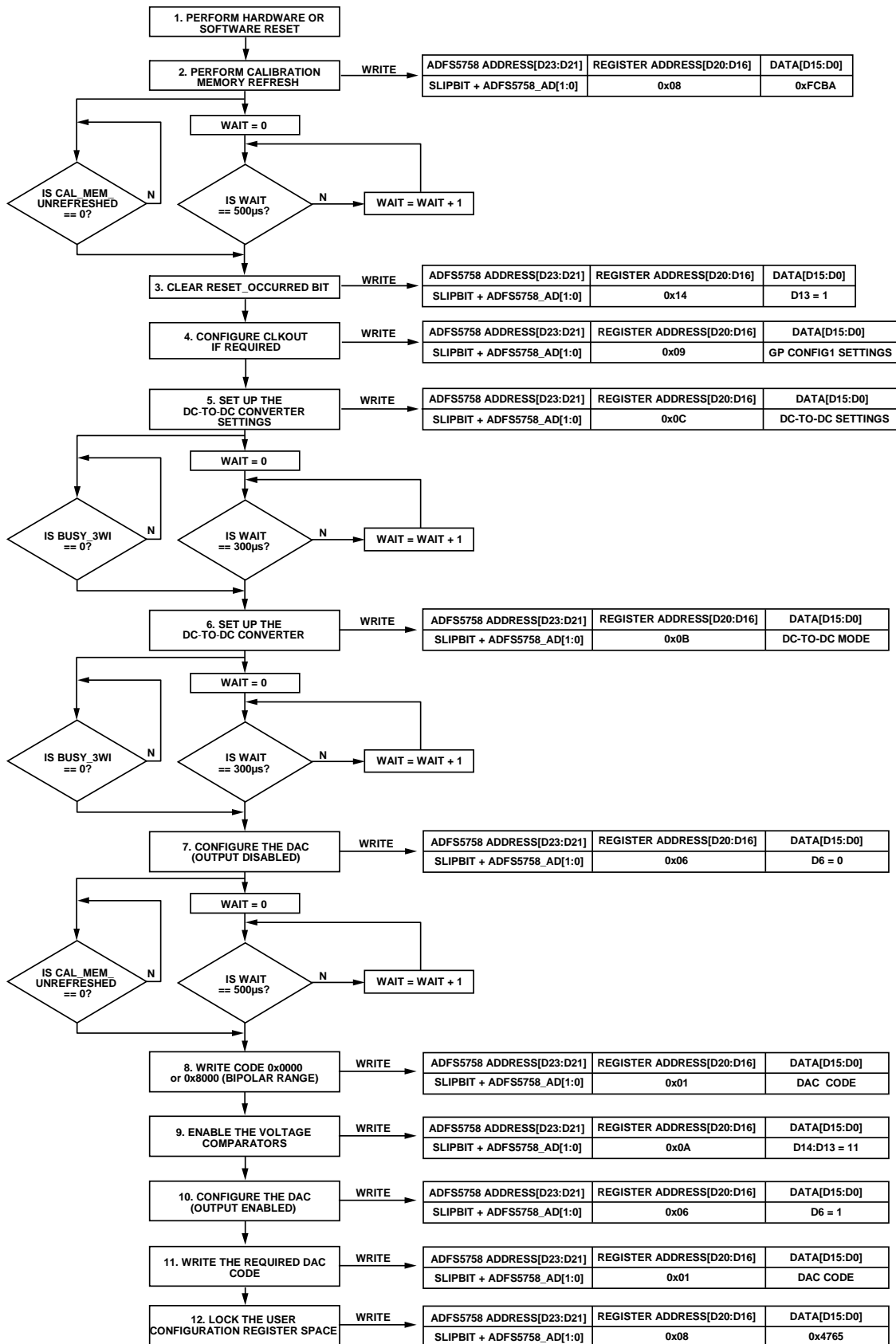

NOTES
1. LDAC FUNCTIONALITY IS NOT BEING USED. DEFAULT DC-TO-DC CURRENT LIMIT IS BEING USED.

Figure 93. Example Configuration to Enable the Output Correctly (CRC Disabled for Simplicity)

REGISTER DETAILS

Table 27. Register Summary

Address	Name	Description	Reset	Access
0x00	NOP	NOP register.	0x000000	R
0x01	DAC_INPUT	DAC input register.	0x010000	R/W
0x02	DAC_OUTPUT	DAC output register.	0x020000	R
0x03	CLEAR_CODE	Clear code register.	0x030000	R/W
0x04	USER_GAIN	User gain register.	0x04FFFF	R/W
0x05	USER_OFFSET	User offset register.	0x058000	R/W
0x06	DAC_CONFIG	DAC configuration register.	0x060C00	R/W
0x07	SW_LDAC	Software LDAC register.	0x070000	R0/W
0x08	Key	Key register.	0x080000	R0/W
0x09	GP_CONFIG1	General-Purpose Configuration 1 register.	0x090204	R/W
0x0A	GP_CONFIG2	General-Purpose Configuration 2 register.	0x0A0200	R/W
0x0B	DCDC_CONFIG1	DC-to-DC Configuration 1 register.	0x0B0000	R/W
0x0C	DCDC_CONFIG2	DC-to-DC Configuration 2 register.	0x0C100	R/W
0x0D	Reserved	Reserved.	0x0D0000	N/A ¹
0x0E	Reserved	Reserved.	0x0E0000	N/A ¹
0x0F	WDT_CONFIG	WDT configuration register.	0x0F0009	R/W
0x10	DIGITAL_DIAG_CONFIG	Digital diagnostic configuration register.	0x10005D	R/W
0x11	ADC_CONFIG	ADC configuration register.	0x110000	R/W
0x12	FAULT_PIN_CONFIG	FAULT pin configuration register.	0x120000	R/W
0x13	TWO_STAGE_READBACK_SELECT	Two stage readback select register.	0x130000	R/W
0x14	DIGITAL_DIAG_RESULTS	Digital diagnostic results register.	0x14A000	R
0x15	ANALOG_DIAG_RESULTS	Analog diagnostic results register.	0x150000	R
0x16	Status	Status register.	0x160000	R
0x17	CHIP_ID	Chip ID register.	0x170101	R
0x18	FREQ_MONITOR	Frequency monitor register.	0x180000	R
0x19	DEVICE_ID_0	Device ID Byte 0 and Byte 1 register.	0x190000	R
0x1A	DEVICE_ID_1	Device ID Byte 2 and Byte 3 register.	0x1A0000	R
0x1B	DEVICE_ID_2	Device ID Byte 4 and Byte 5 register.	0x1B0000	R
0x1C	DEVICE_ID_3	Device ID Byte 6 register, currently unused.	0x1C0000	R

¹ Any read or write to this register flags the INVALID_SPI_ACCESS_ERR bit in the digital diagnostics register.

NOP Register**Address: 0x00, Reset: 0x000000, Name: NOP**

Write 0x0000 to Bits[D15:D0] at this address to perform a no operation (NOP) command. Bits[15:0] of this register always read back as 0x0000.

Table 28. Bit Descriptions for NOP

Bits	Bit Name	Description	Reset	Access
21	FAULT_PIN_STATUS	The FAULT_PIN_STATUS bit reflects the inverted current status of the FAULT pin.	0x0	R
[20:16]	REGISTER_ADDRESS	Register address.	0x0	R
[15:0]	NOP command	Write 0x0000 to perform a NOP command.	0x0	R0/W

DAC Input Register**Address: 0x01, Reset: 0x010000, Name: DAC_INPUT**

Bits[D15:D0] consists of the 16-bit data to be written to the DAC. If the $\overline{\text{LDAC}}$ pin is tied low (that is, active), the DAC_INPUT register contents are written directly to the DAC_OUTPUT register without any $\overline{\text{LDAC}}$ functionality dependence. If the $\overline{\text{LDAC}}$ pin is tied high, the contents of the DAC_INPUT register are written to the DAC_OUTPUT register when the $\overline{\text{LDAC}}$ pin is brought low or when the software LDAC command is written.

Table 29. Bit Descriptions for DAC_INPUT

Bits	Bit Name	Description	Reset	Access
21	FAULT_PIN_STATUS	The FAULT_PIN_STATUS bit reflects the inverted current status of the FAULT pin.	0x0	R
[20:16]	REGISTER_ADDRESS	Register address.	0x0	R
[15:0]	DAC_INPUT_DATA	DAC input data.	0x0	R/W

DAC Output Register**Address: 0x02, Reset: 0x020000, Name: DAC_OUTPUT**

DAC_OUTPUT is a read only register and contains the latest calibrated 16-bit DAC output value. If a clear event occurs due to a WDT fault, this register contains the clear code until the DAC is updated to another code.

Table 30. Bit Descriptions for DAC_OUTPUT

Bits	Bit Name	Description	Reset	Access
21	FAULT_PIN_STATUS	The FAULT_PIN_STATUS bit reflects the inverted current status of the FAULT pin.	0x0	R
[20:16]	REGISTER_ADDRESS	Register address.	0x0	R
[15:0]	DAC_OUTPUT_DATA	DAC output data. For example, the last calibrated 16-bit DAC output value.	0x0	R

Clear Code Register**Address: 0x03, Reset: 0x030000, Name: CLEAR_CODE**

When writing to the CLEAR_CODE register, Bits[D15:D0] consist of the clear code to which the DAC clears on the occurrence of a clear event (for example, a WDT fault). After a clear event, the DAC_INPUT register must be rewritten to with the 16-bit data to be written to the DAC, even if it is the same data as previously written before the clear event. Performing an LDAC write (either hardware or software) does not update the DAC_OUTPUT register to a new code until the DAC_INPUT register is first written to.

Table 31. Bit Descriptions for CLEAR_CODE

Bits	Bit Name	Description	Reset	Access
21	FAULT_PIN_STATUS	The FAULT_PIN_STATUS bit reflects the inverted current status of the FAULT pin.	0x0	R
[20:16]	REGISTER_ADDRESS	Register address.	0x0	R
[15:0]	CLEAR_CODE	Clear code. The DAC clears to this code upon a clear event, for example, a WDT fault.	0x0	R/W

User Gain Register**Address: 0x04, Reset: 0x04FFFF, Name: USER_GAIN**

The 16-bit USER_GAIN register allows the user to adjust the gain of the DAC channel in steps of 1 LSB. The USER_GAIN register coding is straight binary. The default code is 0xFFFF. In theory, the gain can be tuned across the full range of the output. In practice, the maximum recommended gain trim is approximately 50% of the programmed range to maintain accuracy.

Table 32. Bit Descriptions for USER_GAIN

Bits	Bit Name	Description	Reset	Access
21	FAULT_PIN_STATUS	The FAULT_PIN_STATUS bit reflects the inverted current status of the FAULT pin.	0x0	R
[20:16]	REGISTER_ADDRESS	Register address.	0x0	R
[15:0]	USER_GAIN	User gain correction code.	0xFFFF	R/W

User Offset Register**Address: 0x05, Reset: 0x058000, Name: USER_OFFSET**

The 16-bit USER_OFFSET register allows the user to adjust the offset of the DAC channel by $-32,768$ LSBs to $+32,768$ LSBs in steps of 1 LSB. The USER_OFFSET register coding is straight binary. The default code is 0x8000, which results in zero offset programmed to the output.

Table 33. Bit Descriptions for USER_OFFSET

Bits	Bit Name	Description	Reset	Access
21	FAULT_PIN_STATUS	The FAULT_PIN_STATUS bit reflects the inverted current status of the FAULT pin.	0x0	R
[20:16]	REGISTER_ADDRESS	Register address.	0x0	R
[15:0]	USER_OFFSET	User offset correction code.	0x8000	R/W

DAC Configuration Register**Address: 0x06, Reset: 0x060C00, Name: DAC_CONFIG**

This register configures the DAC (range, internal/external R_{SET}, and output enable), enables the output stage circuitry, and configures the slew rate control function.

Table 34. Bit Descriptions for DAC_CONFIG

Bits	Bit Name	Description	Reset	Access
21	FAULT_PIN_STATUS	The FAULT_PIN_STATUS bit reflects the inverted current status of the FAULT pin.	0x0	R
[20:16]	REGISTER_ADDRESS	Register address.	0x0	R
[15:13]	SR_STEP	Slew rate step. In conjunction with the slew rate clock, the slew rate step defines by how much the output value changes at each update. Together, both parameters define the rate of change of the output value. 000: 4 LSB (default). 001: 12 LSB. 010: 64 LSB. 011: 120 LSB. 100: 256 LSB. 101: 500 LSB. 110: 1820 LSB. 111: 2048 LSB.	0x0	R/W
[12:9]	SR_CLOCK	Slew rate clock. Slew rate clock defines the rate at which the digital slew is updated. 0000: 240 kHz. 0001: 200 kHz. 0010: 150 kHz. 0011: 128 kHz. 0100: 64 kHz. 0101: 32 kHz. 0110: 16 kHz (default). 0111: 8 kHz.	0x6	R/W

Bits	Bit Name	Description	Reset	Access
		1000: 4 kHz. 1001: 2 kHz. 1010: 1 kHz. 1011: 512 Hz. 1100: 256 Hz. 1101: 128Hz. 1110: 64 Hz. 1111: 16 Hz.		
8	SR_EN	Enable slew rate control. 0: disable (default). 1: enable.	0x0	R/W
7	RSET_EXT_EN	Enable external current setting resistor. 0: select internal R _{SET} resistor (default). 1: select external R _{SET} resistor.	0x0	R/W
6	OUT_EN	Enable V _{IOUT} . 0: disable V _{IOUT} output (default). 1: enable V _{IOUT} output.	0x0	R/W
5	INT_EN	Enable internal buffers. 0: disable (default). 1: enable. Setting this bit powers up the DAC and internal amplifiers. Setting this bit does not enable the output. It is recommended to set this bit and allow a >200 μs delay before enabling the output. This delay results in a reduced output enable glitch.	0x0	R/W
4	OVRNG_EN	Enable 20% voltage overrange. 0: disable (default). 1: enable.	0x0	R/W
[3:0]	Range	Select output range. Note that changing the contents of the range bits initiates an internal calibration memory refresh and, therefore, a subsequent SPI write must not be performed until the CAL_MEM_UNREFRESHED bit in the DIGITAL_DIAG_RESULTS register returns to 0. Writes to invalid range codes are ignored. 0000: 0 V to 5 V voltage range (default). 0001: 0 V to 10 V voltage range. 0010: ±5 V voltage range. 0011: ±10 V voltage range. 1000: 0 mA to 20 mA current range. 1001: 0 mA to 24 mA current range. 1010: 4 mA to 20 mA current range. 1011: ±20 mA current range. 1100: ±24 mA current range. 1101: -1 mA to +22 mA current range.	0x0	R/W

Software LDAC Register

Address: 0x07, Reset: 0x070000, Name: SW_LDAC

Writing 0x1DAC to this register performs a software LDAC update on the device matching the address bits within the SPI frame. If the GLOBAL_SW_LDAC bit in the GP_CONFIG2 register is set, the address bits are ignored and all devices sharing the same SPI bus are updated via the SW_LDAC command. Bits[15:0] of this register always read back as 0x0000.

Table 35. Bit Descriptions for SW_LDAC

Bits	Bit Name	Description	Reset	Access
21	FAULT_PIN_STATUS	The FAULT_PIN_STATUS bit reflects the inverted current status of the FAULT pin.	0x0	R
[20:16]	REGISTER_ADDRESS	Register address.	0x0	R
[15:0]	LDAC_COMMAND	Software LDAC. Write 0x1DAC to this register to perform a software LDAC instruction.	0x0	R0/W

Key Register

Address: 0x08, Reset: 0x080000, Name: Key

This register accepts specific key codes to perform tasks such as calibration memory refresh and software reset. Bits[15:0] of this register always read back as 0x0000. All unlisted key codes are reserved.

Table 36. Bit Descriptions for Key

Bits	Bit Name	Description	Reset	Access
21	FAULT_PIN_STATUS	The FAULT_PIN_STATUS bit reflects the inverted current status of the FAULT pin.	0x0	R
[20:16]	REGISTER_ADDRESS	Register address.	0x0	R
[15:0]	KEY_CODE	Key code. 0x4765: lock user configuration register space. This key initiates an automatic calculation of the ideal CRC that all subsequent background CRC calculations are compared to. 0x896D: first of two keys to unlock the user configuration register space. 0x57AB: second of two keys to unlock the user configuration register space. 0x15FA: first of two keys to initiate a software reset. 0xAF51: second of two keys to initiate a software reset. 0x1ADC: key to initiate a single ADC conversion on the selected ADC channel. 0x0D06: first of two keys to reset the watchdog timer. 0xF00D: second of two keys to reset the watchdog timer. 0x5CEA: key to force a recalculation of the background CRC. 0xFCBA: key to initiate a calibration memory refresh to the shadow registers. Note that this key is only valid the first time it is run and has no effect if subsequent writes occur within a given system reset cycle.	0x0	R0/W

General-Purpose Configuration 1 Register

Address: 0x09, Reset: 0x090204, Name: GP_CONFIG1

This register is used to configure functions such as the temperature comparator threshold and CLKOUT, as well as enabling other miscellaneous features.

Table 37. Bit Descriptions for GP_CONFIG1

Bits	Bit Name	Description	Reset	Access
21	FAULT_PIN_STATUS	The FAULT_PIN_STATUS bit reflects the inverted current status of the FAULT pin.	0x0	R
[20:16]	REGISTER_ADDRESS	Register address.	0x0	R
[15:14]	Reserved	Reserved. Do not alter the default value of this bit.	0x0	R
[13:12]	SET_TEMP_THRESHOLD	Set the temperature comparator threshold value. 00: 142°C (default). 01: 127°C. 10: 112°C. 11: 97°C.	0x0	R/W
[11:10]	CLKOUT_CONFIG	Configure the CLKOUT pin. 00: disable; no clock is output on the CLKOUT pin (default). 01: enable; clock is output on CLKOUT pin according to the CLKOUT_FREQ bits (Bits[9:7]). 10: reserved (do not select this option). 11: reserved (do not select this option).	0x0	R/W

Bits	Bit Name	Description	Reset	Access
[9:7]	CLKOUT_FREQ	Configure the frequency of CLKOUT. 000: 416 kHz. 001: 435 kHz. 010: 454 kHz. 011: 476 kHz. 100: 500 kHz (default). 101: 526 kHz. 110: 555 kHz. 111: 588 kHz.	0x4	R/W
6	HART_EN	Enable the path to the C _{HART} pin. 0: output of the DAC drives the output stage directly (default). 1: C _{HART} path is coupled to the DAC output to allow a HART modem connection or connection of a slew capacitor.	0x0	R/W
5	NEG_OFFSET_EN	Enable negative offset in unipolar V _{OUT} mode. When set, this bit offsets the currently enabled unipolar output range by the value listed here. This bit is only applicable to the 0 V to 6 V range and the 0 V to 12 V range. The 0 V to 6 V range becomes –300 mV to +5.7 V; the 0 V to 12 V range becomes –400 mV to 11.6 V. 0: disable (default). 1: enable.	0x0	R/W
4	CLEAR_NOW_EN	Enables clear to occur immediately, even if the output slew feature is currently enabled. 0: disable (default). 1: enable.	0x0	R/W
3	SPI_DIAG_QUIET_EN	Enable SPI diagnostic quiet mode. When this bit is enabled, SPI_CRC_ERR, SLIPBIT_ERR, and SCLK_COUNT_ERR are not included in the logical OR calculation, which creates the DIG_DIAG_STATUS bit in the status register. They are also masked from affecting the FAULT pin if this bit is set. 0: disable (default). 1: enable.	0x0	R/W
2	OSC_STOP_DETECT_EN	Enable automatic 0x07DEAD code on SDO if the internal oscillator (MCLK) stops. 0: disable. 1: enable (default).	0x1	R/W
1	Reserved	Reserved. Do not alter the default value of this bit.	0x0	R/W
0	Reserved	Reserved. Do not alter the default value of this bit.	0x0	R/W

General-Purpose Configuration 2 Register

Address: 0x0A, Reset: 0x0A0200, Name: GP_CONFIG2

This register is used to configure and enable functions such as fault injection, internal current output monitor, and global software LDAC.

Table 38. Bit Descriptions for GP_CONFIG2

Bits	Bit Name	Description	Reset	Access
21	FAULT_PIN_STATUS	The FAULT_PIN_STATUS bit reflects the inverted current status of the FAULT pin.	0x0	R
[20:16]	REGISTER_ADDRESS	Register address.	0x0	R
15	RESERVED	Reserved.	0x0	R0
[14:13]	COMPARATOR_CONFIG	Configures the voltage comparators including ability to drive both the temperature and voltage comparator inputs directly for test purposes. Note that the temperature comparators are permanently enabled. 00: disable voltage comparators (default). 01: with all comparators enabled, drive all comparator inputs high for diagnostic test purposes. This causes all voltage comparator result flags to assert in the ANALOG_DIAG_RESULTS register. 10: with all comparators enabled, drive all comparator inputs low for diagnostic test purposes. This causes all voltage and temperature comparator result flags to assert in the ANALOG_DIAG_RESULTS register.	0x0	R/W

Bits	Bit Name	Description	Reset	Access
		11: enable voltage comparators. Note that the INT_EN bit in the DAC_CONFIG register must be set for the REFIN buffer to be powered up and this node available to the REFIN comparator.		
12	VLDO_CAP_DETECT_EN	Initiates a diagnostic test to detect a missing external capacitor on the VLDO pin. Note that this bit returns to 0 once the test is complete and thus, polling this bit can be used to determine when the test is complete. 0: disable (default). 1: enable.	0x0	R/W
11	RESERVED	Reserved.	0x0	R/W
10	GLOBAL_SW_LDAC	When enabled, the ADFS5758 address bits are ignored when performing a software LDAC command, enabling multiple devices to be simultaneously updated using one SW_LDAC command. 0: disable (default). 1: enable.	0x0	R/W
9	FAULT_TIMEOUT	Enable reduced fault detect timeout. This bit configures the delay from when the analog block indicates a V _{OUT} fault has been detected to the associated change of the relevant bit in the ANALOG_DIAG_RESULTS register. This feature provides flexibility to accommodate a variety of output load values. 0: fault detect timeout = 25 ms. 1: fault detect timeout = 6.5 ms (default).	0x1	R/W
[8:5]	FAULT_INJ_3WI	3WI Fault Injection Enable. All unlisted codes are reserved and must not be selected. 0000: no 3WI fault injection (default). 0100: enable fault injection on 3-wire interface by forcing DCLK low.	0x0	R/W
4	DAC_LATCH_MON_FAULT_INJ	If this bit is enabled, the signal output from the DAC is changed, which triggers the DAC_LATCH_MON_ERR bit in the DIGITAL_DIAG_RESULTS register. 0: disable (default). 1: enable.	0x0	R/W
3	DUAL_CAL_FAULT_INJ	If this bit is enabled, a bit is input to the internal DAC controller circuitry, which causes an error in the internal DAC calibration calculation. This causes the two calculations in the subsequent dual calibration test to disagree and flag the error via the DUAL_CAL_ERR bit in the DIGITAL_DIAG_RESULTS register. 0: disable (default). 1: enable.	0x0	R/W
2	INVERSE_DAC_CHECK_FAULT_INJ	If this bit is enabled, a bit is input to the internal DAC controller circuitry, which causes an error in the DAC inverse calculation. This causes the INVERSE_DAC_CHECK_ERR flag to set in the DIGITAL_DIAG_RESULTS register when completing the subsequent calculation. 0: disable (default). 1: enable.	0x0	R/W
1	BKGND_CRC_FAULT_INJ	If this bit is enabled, a fault is injected into one of the bits that is used to build the CRC which is checked against the ideal CRC. This is flagged by the BKGND_CRC_ERR bit in the DIGITAL_DIAG_RESULTS register upon completion of the subsequent background CRC check. 0: disable (default). 1: enable.	0x0	R/W
0	SPI_READ_FAULT_INJ	If this bit is enabled, the MSB of the SPI readback frame flips to ensure mismatch between the read data and the read CRC bits for the subsequent SPI readback operation. This is flagged by the SPI_CRC_ERR in the DIGITAL_DIAG_RESULTS register. 0: disable (default). 1: enable.	0x0	R/W

DC-to-DC Configuration 1 Register

Address: 0x0B, Reset: 0x0B0000, Name: DCDC_CONFIG1

This register is used to configure the dc-to-dc controller mode.

Table 39. Bit Descriptions for DCDC_CONFIG1

Bits	Bit Name	Description	Reset	Access
21	FAULT_PIN_STATUS	The FAULT_PIN_STATUS bit reflects the inverted current status of the FAULT pin.	0x0	R
[20:16]	REGISTER_ADDRESS	Register address.	0x0	R
[15:8]	Reserved	Reserved. Do not alter the default value of these bits.	0x0	R0
7	Reserved	Reserved. Do not alter the default value of this bit.	0x0	R/W
[6:5]	DCDC_MODE	These two bits configure the dc-to-dc converters. 00: DC-to-DC converter powered off (default). 01: DPC current mode. The positive DPC rail tracks the headroom of the current output buffer. 10: DPC voltage mode. The positive DPC rail is regulated to 15 V with respect to $-V_{SENSE}$. 11: PPC current mode. V_{DPC+} is regulated to a user programmable level between 5 V and 25.677 V (depending on the DCDC_VPROG bits, Bits[4:0]) with respect to $-V_{SENSE}$. The ENABLE_PPC_BUFFERS bit (Bit 11 in the ADC_CONFIG register) must be set prior to enabling PPC current mode.	0x0	R/W
[4:0]	DCDC_VPROG	DC-to-dc programmed voltage in PPC mode. V_{DPC+} is regulated to a user programmable level between 5 V (0b00000) and 25.677 V (0b11111), in steps of 0.667 V. V_{DPC+} is regulated with respect to $-V_{SENSE}$.	0x0	R/W

DC-to-DC Configuration 2 Register

Address: 0x0C, Reset: 0x0C0100, Name: DCDC_CONFIG2

This register configures various dc-to-dc die features, such as the dc-to-dc converter current limit and the dc-to-dc die node, to be multiplexed to the ADC.

Table 40. Bit Descriptions for DCDC_CONFIG2

Bits	Bit Name	Description	Reset	Access
21	FAULT_PIN_STATUS	The FAULT_PIN_STATUS bit reflects the inverted current status of the FAULT pin.	0x0	R
[20:16]	REGISTER_ADDRESS	Register address.	0x0	R
[15:13]	Reserved	Reserved. Do not alter the default value of these bits.	0x0	R0
12	BUSY_3WI	Three-wire interface busy indicator. 0: 3-wire interface not currently active. 1: 3-wire interface busy.	0x0	R
11	INTR_SAT_3WI	Three-wire interface saturation flag. This flag is set to 1 when the interrupt detection circuitry is automatically disabled due to six consecutive interrupt signals. A write to either of the dc-to-dc configuration registers clears this bit to 0.	0x0	R
10	DCDC_READ_COMP_DIS	Disable 3-wire interface read and compare cycle. This read and compare cycle ensures that the contents of the copy of the dc-to-dc configuration registers on the main die match the contents on the dc-to-dc die. 0: enable automatic read and compare cycle (default). 1: when set, this bit disables the automatic read and compare cycle after each 3-wire interface write.	0x0	R/W
[9:8]	Reserved	Reserved. Do not alter the default value of these bits.	0x1	R/W

Bits	Bit Name	Description	Reset	Access
7	VIOUT_OV_ERR_DEGLITCH	Adjust the deglitch time on VI _{OUT} overvoltage error flag. 0: deglitch time set to 1.02 ms (default). 1: deglitch time set to 128 μ s.	0x0	R/W
6	VIOUT_PULLDOWN_EN	Enable the 30 k Ω resistor to ground on VI _{OUT} . 0: disable (default). 1: enable.	0x0	R/W
[5:4]	DCDC_ADC_CONTROL_DIAG	Select which dc-to-dc die node is multiplexed to the ADC on the main die. 00: AGND on dc-to-dc die. 01: internal 2.5 V supply on dc-to-dc die. 10: AV _{DD1} . 11: reserved (do not select this option).	0x0	R/W
[3:1]	DCDC_ILIMIT	These three bits set the dc-to-dc converter current limit. 000: 150 mA (default). 001: 200 mA. 010: 250 mA. 011: 300 mA. 100: 350 mA. 101: 400 mA. 110: 400 mA. 111: 400 mA.	0x0	R/W
0	Reserved	Reserved.	0x0	R/W

Watchdog Timer (WDT) Configuration Register

Address: 0x0F, Reset: 0x0F0009, Name: WDT_CONFIG

This register configures the WDT timeout values. This register also configures the WDT setup in terms of acceptable resets and the resulting response to a WDT fault (for example, clear the output or reset the device).

Table 41. Bit Descriptions for WDT_CONFIG

Bits	Bit Name	Description	Reset	Access
21	FAULT_PIN_STATUS	The FAULT_PIN_STATUS bit reflects the inverted current status of the $\overline{\text{FAULT}}$ pin.	0x0	R
[20:16]	REGISTER_ADDRESS	Register address.	0x0	R
[15:11]	RESERVED	Reserved.	0x0	R
10	CLEAR_ON_WDT_FAIL	Enable clear on watchdog timer fault. If the watchdog timer times out, a clear event occurs, whereby the output is loaded with the clear code stored in the CLEAR_CODE register. 0: disable (default). 1: enable.	0x0	R/W
9	RESET_ON_WDT_FAIL	Enable a software reset to automatically occur if the WDT times out. 0: disable (default). 1: enable.	0x0	R/W
8	KICK_ON_VALID_WRITE	Enable any valid SPI command to reset the WDT. Any active WDT error flags must be cleared before the WDT can be restarted. 0: disable (default). 1: enable.	0x0	R/W
7	DOUBLE_WR_KICK_EN	When this bit is set, two specific consecutive keys codes are required to kick the watchdog timer. Note that any active WDT error flags need to be cleared before the WDT can be restarted. 0: disable (default). A single key code is required to kick the watchdog timer. 1: enable. A double key code is required to kick the watchdog timer.	0x0	R/W
6	WDT_EN	Enable the WDT. The next kick starts the watchdog, assuming there are no active WDT fault flags. 0: disable (default). 1: enable.	0x0	R/W

Bits	Bit Name	Description	Reset	Access
[5:4]	WINDOW_WIDTH	Configure WDT window width. The watchdog timer uses a center threshold and a window width, where the width is a fraction of the center threshold. If the window width is set to 1/1 (default), the watchdog timer is monitored for late watchdog timer resets only. If, however, the window width is set to any value other than 1/1, the watchdog timer is monitored for early or late reset events. 00: 1/1 (default). 01: 1/2. 10: 1/4. 11: 1/8.	0x0	R/W
[3:0]	CENTER_THRESHOLD	Set the center of the window threshold timeout. Setting CENTER_THRESHOLD[3:0] to a binary value beyond 0b1010 results in the default setting of 1 second 0000: 1 ms. 0001: 5 ms. 0010: 10 ms. 0011: 25 ms. 0100: 50 ms. 0101: 100 ms. 0110: 250 ms. 0111: 500 ms. 1000: 750 ms. 1001: 1 sec (default). 1010: 2 sec.	0x9	R/W

Digital Diagnostic Configuration Register

Address: 0x10, Reset: 0x10005D, Name: DIGITAL_DIAG_CONFIG

This register configures various digital diagnostic features of interest for a particular application.

Table 42. Bit Descriptions for DIGITAL_DIAG_CONFIG

Bits	Bit Name	Description	Reset	Access
21	FAULT_PIN_STATUS	The FAULT_PIN_STATUS bit reflects the inverted current status of the FAULT pin.	0x0	R
[20:16]	REGISTER_ADDRESS	Register address.	0x0	R
[15:9]	RESERVED	Reserved.	0x0	R0
[8:7]	BKGND_CRC_MON_MODE	Select memory map CRC monitoring mode. 00: user controls CRC check using a key code (default). 01: CRC automatically done on completion of any valid SPI frame. 10: CRC runs continually in background. 11: CRC runs continually in background.	0x0	R/W
6	DAC_LATCH_MON_EN	Enable a diagnostic monitor on the DAC latches. This feature monitors the actual digital code driving the DAC and compares it with the digital code generated within the digital block. Any difference between the two codes causes the DAC_LATCH_MON_ERR flag to be set in the DIGITAL_DIAG_RESULTS register. 0: disable. 1: enable (default).	0x1	R/W
5	DUAL_CAL_EN	Enable internal calibration on the 16-bit user DAC code to be completed twice. The DAC is only updated if both results match. If a fail is registered, no DAC write occurs and the DUAL_CAL_ERR flag in the DIGITAL_DIAG_RESULTS register is set. Note that t_{14} (SYNC rising edge to DAC output response time) extends from 1.5 μ s to 2 μ s if this feature is enabled. 0: disable (default). 1: enable.	0x0	R/W

Bits	Bit Name	Description	Reset	Access
4	INVERSE_DAC_CHECK_EN	Enable check for DAC code vs. inverse DAC code error. 0: disable. 1: enable (default).	0x1	R/W
3	CAL_MEM_CRC_EN	Enable CRC of calibration memory upon calibration memory refresh. 0: disable. 1: enable (default).	0x1	R/W
2	FREQ_MON_EN	Enable the internal frequency monitor on the internal oscillator (MCLK). 0: disable. 1: enable (default).	0x1	R/W
1	CFG_LOCK_CHECK_EN	Enable a check for writes to the user configuration space when locked. When enabled, this diagnostic feature checks for any writes that occur while the user configuration space is locked. Such writes are ignored and flagged in the corresponding flag within the DIGITAL_DIAG_RESULTS register. 0: disable (default). 1: enable.	0x0	R/W
0	SPI_CRC_EN	Enable SPI CRC function. 0: disable. 1: enable (default).	0x1	R/W

ADC Configuration Register

Address: 0x11, Reset: 0x110000, Name: ADC_CONFIG

This register configures the ADC into one of four modes of operation: key sequencing, automatic sequencing, single immediate conversion of the currently selected ADC_IP_SELECT node, or single-key conversion.

Table 43. Bit Descriptions for ADC_CONFIG

Bits	Bit Name	Description	Reset	Access
21	FAULT_PIN_STATUS	The FAULT_PIN_STATUS bit reflects the inverted current status of the FAULT pin.	0x0	R
[20:16]	REGISTER_ADDRESS	Register address.	0x0	R
[15:11]	RESERVED	Reserved.	0x0	R/W
[10:8]	SEQUENCE_COMMAND	ADC sequence command bits. 000: set depth of the sequencer. The contents of SEQUENCE_DATA[7:5] bits correspond to the depth of the sequencer: 000 = 1 channel, 001 = 2 channels ... 111 = 8 channels. 001: set the channel SEQUENCE_DATA[7:5] with the ADC input, ADC_IP_SELECT[4:0]. 010: enable/disable key sequencer mode, depending on the contents of SEQUENCE_DATA[7:5] bits. SEQUENCE_DATA[7:5] = 001: enable key sequencer. SEQUENCE_DATA[7:5] ≠ 001: disable key sequencer. 011: enable/disable automatic sequencer mode, depending on the contents of the SEQUENCE_DATA[7:5] bits. SEQUENCE_DATA[7:5] = 001: enable automatic sequencer. SEQUENCE_DATA[7:5] ≠ 001: disable automatic sequencer. 100: initiate a single conversion on the ADC_IP_SELECT[4:0] input. This disables autosequencing. SEQUENCE_DATA[7:5] bits are not applicable for this command. 101: set up the ADC for future individual ADC conversions (if not using the key sequencer), using the 0x1ADC key code. SEQUENCE_DATA[7:5] bits are not applicable for this command. 110: reserved (do not select this option). 111: reserved (do not select this option).	0x0	R/W
[7:5]	SEQUENCE_DATA	The function of the contents of this field is dependent on the command being issued by the SEQUENCE_COMMAND[10:8] bits.	0x0	R/W

Bits	Bit Name	Description	Reset	Access
[4:0]	ADC_IP_SELECT	Select which node to multiplex to the ADC. All unlisted 5-bit codes are reserved and returns an ADC result of zero. 00000: main die temperature. 00001: dc-to-dc die temperature. 00010: reserved (do not select this option). 00011: REFIN. Note that INT_EN bit in the DAC_CONFIG register must be set for the REFIN buffer to be powered up and this node to be available to the ADC. 00100: REF2; internal 1.23 V reference voltage. 00101: reserved (do not select this option). 00110: reserved (do not select this option). 01100: ADC2 pin input. 01101: voltage on +V _{SENSE} buffer output. 01110: voltage on -V _{SENSE} buffer output 01111: ADC1 pin input (0 V to 1.25 V input range). 10000: ADC1 pin input (0 V to 0.5 V input range). 10001: ADC1 pin input (0 V to 2.5 V input range). 10010: ADC1 pin input (± 0.5 V input range). 10011: reserved (do not select this option). 10100: INT_AVCC. 10101: V _{LDO} . 10110: V _{LOGIC} . 11000: REFGND. 11001: AGND. 11010: DGND. 11011: V _{DPC+} . 11100: AV _{DD2} . 11101: AV _{SS} . 11110: dc-to-dc die node, configured in DCDC_CONFIG2 register. 11111: REFOUT.	0x0	R/W

FAULT Pin Configuration Register

Address: 0x12, Reset: 0x120000, Name: FAULT_PIN_CONFIG

This register is used to mask particular fault bits from the FAULT pin, if so desired.

Table 44. Bit Descriptions for FAULT_PIN_CONFIG

Bits	Bit Name	Description	Reset	Access
21	FAULT_PIN_STATUS	The FAULT_PIN_STATUS bit reflects the inverted current status of the <u>FAULT</u> pin.	0x0	R
[20:16]	REGISTER_ADDRESS	Register address.	0x0	R
15	INVALID_SPI_ACCESS_ERR	If this bit is set, do not map the INVALID_SPI_ACCESS_ERR fault flag to the <u>FAULT</u> pin.	0x0	R/W
14	VIOUT_OV_ERR	If this bit is set, do not map the VIOUT_OV_ERR fault flag to the <u>FAULT</u> pin.	0x0	R/W
13	CFG_LOCK_CHECK_ERR	If this bit is set, do not map the CFG_LOCK_CHECK_ERR flag to the <u>FAULT</u> pin.	0x0	R/W
12	INVERSE_DAC_CHECK_ERR	If this bit is set, do not map the INVERSE_DAC_CHECK_ERR flag to the <u>FAULT</u> pin.	0x0	R/W
11	DUAL_CAL_ERR	If this bit is set, do not map the DUAL_CAL_ERR flag to the <u>FAULT</u> pin.	0x0	R/W
10	OSCILLATOR_STOP_DETECT	If this bit is set, do not map the clock stop error to the <u>FAULT</u> pin.	0x0	R/W
9	DAC_LATCH_MON_ERR	If this bit is set, do not map the DAC_LATCH_MON_ERR fault flag to the <u>FAULT</u> pin.	0x0	R/W
8	WDT_ERR	If this bit is set, do not map the WDT_ERR flag to the <u>FAULT</u> pin.	0x0	R/W
7	SLIPBIT_ERR	If this bit is set, do not map the SLIPBIT_ERR error flag to the <u>FAULT</u> pin.	0x0	R/W
6	SPI_CRC_ERR	If this bit is set, do not map the SPI_CRC_ERR error flag to the pin.	0x0	R/W
5	Reserved	Reserved.	0x0	R/W
4	DCDC_P_SC_ERR	If this bit is set, do not map the positive rail dc-to-dc short circuit error flag to the	0x0	R/W

Bits	Bit Name	Description	Reset	Access
		FAULT pin.		
3	IOUT_OC_ERR	If this bit is set, do not map the current output open-circuit error flag to the $\overline{\text{FAULT}}$ pin.	0x0	R/W
2	VOUT_SC_ERR	If this bit is set, do not map the voltage output short-circuit error flag to the $\overline{\text{FAULT}}$ pin.	0x0	R/W
1	DCDC_DIE_TEMP_ERR	If this bit is set, do not map the dc-to-dc die temperature error flag to the $\overline{\text{FAULT}}$ pin.	0x0	R/W
0	MAIN_DIE_TEMP_ERR	If this bit is set, do not map the main die temperature error flag to the $\overline{\text{FAULT}}$ pin.	0x0	R/W

Two Stage Readback Select Register

Address: 0x13, Reset: 0x130000, Name: TWO_STAGE_READBACK_SELECT

This register selects the address of the register required for a two stage readback operation. The address of the register selected for readback is stored in Bits[D4:D0].

Table 45. Bit Descriptions for TWO_STAGE_READBACK_SELECT

Bits	Bit Name	Description	Reset	Access
21	FAULT_PIN_STATUS	The FAULT_PIN_STATUS bit reflects the inverted current status of the $\overline{\text{FAULT}}$ pin.	0x0	R
[20:16]	REGISTER_ADDRESS	Register address.	0x0	R
[15:7]	Reserved	Reserved.	0x0	R
[6:5]	READBACK_MODE	These bits control the SPI readback mode. 0: two stage SPI readback mode (default). 01: autostatus readback mode: the status register contents are shifted out on SDO for every SPI frame. 10: shared $\overline{\text{SYNC}}$ autostatus readback mode. This mode allows the use of a shared $\overline{\text{SYNC}}$ line on multiple devices (distinguished using the hardware address pins). After each valid write to a device, a flag is set. This mode behaves similar to the normal autostatus readback mode, except that the device does not output the status register contents on SDO as $\overline{\text{SYNC}}$ goes low, unless the internal flag is set (that is, the previous SPI write is valid). 11: the status register contents and the previous SPI frame instruction are alternately available on SDO.	0x0	R/W
[4:0]	READBACK_SELECT	Select readback address for a two stage readback. 0x00: NOP register (default). 0x01: DAC_INPUT register. 0x02: DAC_OUTPUT register. 0x03: CLEAR_CODE register. 0x04: USER_GAIN register. 0x05: USER_OFFSET register. 0x06: DAC_CONFIG register. 0x07: SW_LDAC register. 0x08: key register. 0x09: GP_CONFIG1 register. 0x0A: GP_CONFIG2 register. 0x0B: DCDC_CONFIG1 register. 0x0C: DCDC_CONFIG2 register. 0x0D: reserved (do not select this option). 0x0E: reserved (do not select this option). 0x0F: WDT_CONFIG register. 0x10: DIGITAL_DIAG_CONFIG register. 0x11: ADC_CONFIG register. 0x12: FAULT_PIN_CONFIG register. 0x13: TWO_STAGE_READBACK_SELECT register. 0x14: DIGITAL_DIAG_RESULTS register. 0x15: ANALOG_DIAG_RESULTS register. 0x16: status register. 0x17: CHIP_ID register.	0x0	R/W

Bits	Bit Name	Description	Reset	Access
		0x16: status register. 0x17: CHIP_ID register. 0x18: FREQ_MONITOR register. 0x19: DEVICE_ID_0 register. 0x1A: DEVICE_ID_1 register. 0x1B: DEVICE_ID_2 register. 0x1C: DEVICE_ID_3 register.		

Digital Diagnostic Results Register

Address: 0x14, Reset: 0x14A000, Name: DIGITAL_DIAG_RESULTS

This register contains an error flag for the on-chip digital diagnostic features, most of which are configurable using the digital diagnostic configuration register. This register also contains a flag to indicate that a reset occurred, as well as a flag to indicate that the calibration memory has not refreshed or an invalid SPI access attempted. With the exception of the CAL_MEM_UNREFRESHED and SLEW_BUSY flags, all of these flags require a 1 to be written to them to update them to their current value. The CAL_MEM_UNREFRESHED and SLEW_BUSY flags automatically clear when the calibration memory refresh or output slew, respectively, is complete. When the corresponding enable bits in the DIGITAL_DIAG_CONFIG register are not enabled, the respective flag bits read as zero.

Table 46. Bit Descriptions for DIGITAL_DIAG_RESULTS

Bits	Bit Name	Description	Reset	Access
21	FAULT_PIN_STATUS	The FAULT_PIN_STATUS bit reflects the inverted current status of the FAULT pin.	0x0	R
[20:16]	REGISTER_ADDRESS	Register address.	0x0	R
15	CAL_MEM_UNREFRESHED	Calibration memory unrefreshed flag. Note that modifying the range bits in the DAC_CONFIG register also initiates a calibration memory refresh, which asserts this bit. Unlike the R/W-1-C bits in this register, this bit is automatically cleared after the calibration memory refresh completes. 0: calibration memory is refreshed. 1: calibration memory is unrefreshed (default on power-up). Note that this bit asserts if the range bits are modified in the DAC_CONFIG register.	0x1	R
14	SLEW_BUSY	This flag is set to 1 when the DAC is actively slewing. Unlike the R/W-1-C bits in this register, this bit is automatically cleared when slewing is complete.	0x0	R
13	RESET_OCCURRED	This bit flags that a reset occurred (default on power-up is therefore Logic 1).	0x1	R/W-1-C
12	ERR_3WI	This bit flags an error in the interdie 3-wire interface communications.	0x0	R/W-1-C
11	WDT_LATE_ERR	This bit flags a late WDT fault.	0x0	R/W-1-C
10	WDT_EARLY_ERR	This bit flags an early WDT fault.	0x0	R/W-1-C
9	BKGND_CRC_ERR	This bit flags an error for the background CRC calculation of the combined calibration memory and register configuration space. Note that this bit also flags if a parity error occurs during a 3-wire read and compare transaction.	0x0	R/W-1-C
8	DAC_LATCH_MON_ERR	This bit flags if the output of the DAC latches does not match the input.	0x0	R/W-1-C
7	DUAL_CAL_ERR	This bit flags if the dual calibration comparison registers a fail.	0x0	R/W-1-C
6	INVERSE_DAC_CHECK_ERR	This bit flags if a fault is detected between the DAC code driven by the digital core and an inverted copy.	0x0	R/W-1-C
5	CAL_MEM_CRC_ERR	This bit flags a CRC error for the CRC calculation of the calibration memory upon refresh.	0x0	R/W-1-C
4	INVALID_SPI_ACCESS_ERR	This bit flags if an invalid SPI access is attempted, such as writing to or reading from an invalid or reserved address. This bit also flags if an SPI write is attempted directly after powering up but before a calibration memory refresh is performed or if an SPI write is attempted while a calibration memory refresh is in progress. Performing a two stage readback is permitted during a calibration memory refresh and does not cause this flag to set. Attempting to write to a read only register also causes this bit to assert.	0x0	R/W-1-C
3	CFG_LOCK_CHECK_ERR	This bit flags if there is a write attempted on the user configuration space when it is locked.	0x0	R/W-1-C
2	SCLK_COUNT_ERR	This bit flags an SCLK falling edge count error. 32 clocks are required if SPI CRC is enabled and 24 clocks or 32 clocks are required if SPI CRC is not enabled.	0x0	R/W-1-C

Bits	Bit Name	Description	Reset	Access
1	SLIPBIT_ERR	This bit flags an SPI frame slip bit error, that is, the MSB of the SPI word is not equal to the inverse of MSB – 1.	0x0	R/W-1-C
0	SPI_CRC_ERR	This bit flags an SPI CRC error.	0x0	R/W-1-C

Analog Diagnostic Results Register

Address: 0x15, Reset: 0x150000, Name: ANALOG_DIAG_RESULTS

This register contains an error flag corresponding to the four voltage nodes (V_{LDO} , INT_AVCC, REFIN, and REFOUT) monitored in the background by comparators, as well as a flag for each die temperature, which is also monitored by comparators. Voltage output short circuit, current output open circuit, V_{IOUT} overvoltage, and dc-to-dc error flags are also contained in this register. Like the DIGITAL_DIAG_RESULTS register, all of the flags contained in this register require a 1 to be written to them to update or clear them. When the corresponding diagnostic features are not enabled, the respective error flags are read as zero.

Table 47. Bit Descriptions for ANALOG_DIAG_RESULTS

Bits	Bit Name	Description	Reset	Access
21	FAULT_PIN_STATUS	The FAULT_PIN_STATUS bit reflects the inverted current status of the FAULT pin.	0x0	R
[20:16]	REGISTER_ADDRESS	Register address.	0x0	R
[15:14]	Reserved	Reserved.	0x0	R0
13	VIOUT_OV_ERR	This bit flags if the voltage at the V_{IOUT} pin goes outside of the V_{DPC+} rail or AV_{SS} rail.	0x0	R/W-1-C
12	Reserved	Reserved.	0x0	R/W-1-C
11	DCDC_P_SC_ERR	This bit flags a dc-to-dc short-circuit error for the positive rail dc-to-dc circuit.	0x0	R/W-1-C
10	Reserved	Reserved.	0x0	R/W-1-C
9	DCDC_P_PWR_ERR	This bit flags a dc-to-dc regulation fault, that is, the dc-to-dc circuitry cannot reach the target V_{DPC+} voltage due to an insufficient AV_{DD1} voltage.	0x0	R/W-1-C
8	VLDO_CAP_ERR	This bit flags an error if no capacitor present on V_{LDO} pin following the capacitor detect test.	0x0	R/W-1-C
7	IOUT_OC_ERR	This bit flags a current output open circuit error. This error bit is set in the case of a current output open circuit and in the case where there is insufficient headroom available to the internal current output driver circuitry to provide the programmed output current.	0x0	R/W-1-C
6	VOUT_SC_ERR	This bit flags a voltage output short-circuit error.	0x0	R/W-1-C
5	DCDC_DIE_TEMP_ERR	This bit flags an overtemperature error for the dc-to-dc die.	0x0	R/W-1-C
4	MAIN_DIE_TEMP_ERR	This bit flags an overtemperature error for the main die.	0x0	R/W-1-C
3	REFOUT_ERR	This bit flags that the REFOUT node is outside of the comparator threshold levels or if its short-circuit current limit occurs.	0x0	R/W-1-C
2	REFIN_ERR	This bit flags that the REFIN node is outside of the comparator threshold levels.	0x0	R/W-1-C
1	INT_AVCC_ERR	This bit flags that the INT_AVCC node is outside of the comparator threshold levels.	0x0	R/W-1-C
0	V_{LDO} _ERR	This bit flags that the V_{LDO} node is outside of the comparator threshold levels or if its short-circuit current limit occurs.	0x0	R/W-1-C

Status Register**Address: 0x16, Reset: 0x160000, Name: Status**

This register contains ADC data and status bits, as well as the WDT, OR'ed analog and digital diagnostics, and the $\overline{\text{FAULT}}$ pin status bits.

Table 48. Bit Descriptions for Status

Bits	Bit Name	Description	Reset	Access
21	FAULT_PIN_STATUS	The FAULT_PIN_STATUS bit reflects the inverted current status of the $\overline{\text{FAULT}}$ pin.	0x0	R
20	DIG_DIAG_STATUS	This bit represents the result of a logical OR of the contents of Bits[15:0] in the DIGITAL_DIAG_RESULTS register, with the exception of the SLEW_BUSY bit. Therefore, if any of these bits are high, the DIG_DIAG_STATUS bit is high. Note that this bit is high on power-up due to the active RESET_OCCURRED flag. A quiet mode is also available (SPI_DIAG_QUIET_EN in the GP_CONFIG1 register), such that the logical OR function only incorporates Bits[D15:D3] of the DIGITAL_DIAG_RESULTS register (with the exception of the SLEW_BUSY bit). If an SPI CRC, SPI slip bit, or SCLK count error occurs, the DIG_DIAG_STATUS bit is not set high.	0x1	R
19	ANA_DIAG_STATUS	This bit represents the result of a logical OR of the contents of Bits[13:0] in the ANALOG_DIAG_RESULTS register. Therefore, if any bit in this register is high, the ANA_DIAG_STATUS bit is high.	0x0	R
18	WDT_STATUS	WDT status bit.	0x0	R
17	ADC_BUSY	ADC busy status bit.	0x0	R
[16:12]	ADC_CH	Address of the ADC channel represented by the ADC_DATA bits in the status register.	0x0	R
[11:0]	ADC_DATA	12 bits of ADC data representing the converted signal addressed by the ADC_CH bits, Bits[4:0].	0x0	R

Chip ID Register**Address: 0x17, Reset: 0x170101, Name: CHIP_ID**

This register contains the silicon revision ID of both the main die and the dc-to-dc die.

Table 49. Bit Descriptions for CHIP_ID

Bits	Bit Name	Description	Reset	Access
21	FAULT_PIN_STATUS	The FAULT_PIN_STATUS bit reflects the inverted current status of the $\overline{\text{FAULT}}$ pin.	0x0	R
[20:16]	REGISTER_ADDRESS	Register address.	0x0	R
[15:11]	Reserved	Reserved.	0x0	R0
[10:8]	DCDC_DIE_CHIP_ID	These bits reflect the revision number of the dc-to-dc die.	0x2	R
[7:0]	MAIN_DIE_CHIP_ID	These bits reflect the revision number of the main die.	0x2	R

Frequency Monitor Register**Address: 0x18, Reset: 0x180000, Name: FREQ_MONITOR**

An internal frequency monitor uses the internal oscillator (MCLK) to create a pulse at a frequency of 1 kHz (MCLK/10,000). This pulse is used to increment a 16-bit counter. The value of the counter is available to read in the FREQ_MONITOR register. The user can poll this register periodically and use it both as a diagnostic tool for the internal oscillator (to monitor that the oscillator is running) and to measure the frequency. This feature is enabled by default via the FREQ_MON_EN bit in the DIGITAL_DIAG_CONFIG register, and allows a robustness check of the internal oscillator.

Table 50. Bit Descriptions for FREQ_MONITOR

Bits	Bit Name	Description	Reset	Access
21	FAULT_PIN_STATUS	The FAULT_PIN_STATUS bit reflects the inverted current status of the $\overline{\text{FAULT}}$ pin.	0x0	R
[20:16]	REGISTER_ADDRESS	Register address.	0x0	R
[15:0]	FREQ_MONITOR	Internal clock counter value.	0x0	R

Device ID Registers

The ADFS5758 device ID consists of a 46-bit value. The data stored in DEVICE_ID_0, DEVICE_ID_1, and DEVICE_ID_2 must be combined to represent a unique, 46-bit identifier. For example, if the data read back from DEVICE_ID_0 is 0xA5D2, the data read back from DEVICE_ID_1 is 0x38A8 and the data read back from DEVICE_ID_2 is 0x14D2. Then, the device ID is 0x14D238A8A5D2.

Device ID Byte 0 and Byte 1 Register

Address: 0x19, Reset: 0x190000, Name: DEVICE_ID_0

Table 51. Bit Descriptions for DEVICE_ID_0

Bits	Bit Name	Description	Reset	Access
21	FAULT_PIN_STATUS	The FAULT_PIN_STATUS bit reflects the inverted current status of the FAULT pin.	0x0	R
[20:16]	REGISTER_ADDRESS	Register address.	0x0	R
[15:8]	DEVICE_ID_0	Device ID Byte 0.	0x0	R
[7:0]	DEVICE_ID_1	Device ID Byte 1.	0x0	R

Device ID Byte 2 and Byte 3 Register

Address: 0x1A, Reset: 0x1A0000, Name: DEVICE_ID_1

Table 52. Bit Descriptions for DEVICE_ID_1

Bits	Bit Name	Description	Reset	Access
21	FAULT_PIN_STATUS	The FAULT_PIN_STATUS bit reflects the current status of the FAULT pin.	0x0	R
[20:16]	REGISTER_ADDRESS	Register address.	0x0	R
[15:11]	LOT_ID_NUM_1	Lot ID number 1.	0x0	R
[10:5]	LOT_ID_2	The second identifier in the lot ID.	0x0	R
[4:0]	LOT_ID_1	The first identifier in the lot ID.	0x0	R

Device ID Byte 4 and Byte 5 Register

Address: 0x1B, Reset: 0x1B0000, Name: DEVICE_ID_2

Table 53. Bit Descriptions for DEVICE_ID_2

Bits	Bit Name	Description	Reset	Access
21	FAULT_PIN_STATUS	The FAULT_PIN_STATUS bit reflects the current status of the FAULT pin.	0x0	R
[20:16]	REGISTER_ADDRESS	Register address.	0x0	R
[15:14]	RESERVED	Reserved.	0x0	R
[13:9]	LOT_ID_NUM_3	Lot ID Number 3.	0x0	R
[8:0]	LOT_ID_NUM_2	Lot ID Number 2.	0x0	R

Device ID Byte 6 Register

Address: 0x1C, Reset: 0x1C0000, Name: DEVICE_ID_3

Table 54. Bit Descriptions for DEVICE_ID_3

Bits	Bit Name	Description	Reset	Access
21	FAULT_PIN_STATUS	The FAULT_PIN_STATUS bit reflects the inverted current status of the FAULT pin.	0x0	R
[20:16]	REGISTER_ADDRESS	Register address.	0x0	R
[15:8]	Reserved	Reserved.	0x0	R
[7:3]	Reserved	Reserved.	0x0	R
[2:0]	GENERIC ID	Generic ID. 000: reserved 001: reserved 010: reserved 011: reserved 100: reserved 101: ADFS5758 110: reserved 111: reserved	0x0	R

APPLICATIONS INFORMATION

Using the example module shown in Figure 94, the module power dissipation (excluding the power dissipated in the load) can be calculated using the methodology shown in the Power Calculation Methodology ($R_{LOAD} = 1\text{ k}\Omega$) section. Assuming a maximum I_{OUT} value of 20 mA and R_{LOAD} value of 1 k Ω , the total module power is calculated as approximately 226 mW. Note that power associated with the external digital isolation is not included in the calculations because this power is dependent on the choice of component used.

Replacing the 1 k Ω load with a short circuit, the power dissipation calculation is shown in the Power Calculation Methodology ($R_{LOAD} = 0\ \Omega$) section, which shows that the total module power becomes approximately 206 mW in a short-circuit load condition.

Power Calculation Methodology ($R_{LOAD} = 1\text{ k}\Omega$)

Table 55. Quiescent Current Power Calculation

Voltage (V)	Current (mA)	Power (mW)
$AV_{DD1} = 24$	$AI_{DD1} = 0.05$	1.2
$AV_{DD2} = 5$	$AI_{DD2} = 2.9$	14.5
$AV_{SS} = -15$	$AI_{SS} = 0.23$	3.45
$V_{LOGIC} = 3.3$	$I_{LOGIC} = 0.01$	0.033

Using the voltage and current values in Table 55, the total quiescent current power is 19.18 mW.

Next, perform the following calculation:

$$(V_{DPC+}) \times (20\text{ mA} + I_{DPC+}) = 22.5\text{ V} \times 20.5\text{ mA} = 461.25\text{ mW}$$

Assume the dc-to-dc converter is at 90% efficiency. Therefore, V_{DPC+} power = 512.5 mW. The total input power at the ADFS5758 side of the ADP1031 PMU is therefore 512.5 mW + 19.18 mW = 531.68 mW. Subtracting the 400 mW load power from this value gives the power associated only with the ADFS5758, which is 131.68 mW.

Assuming an 85% efficiency ADP1031, the total input power becomes 625.5 mW.

$$\text{Total Module Power} = \text{Input Power} - \text{Load Power}$$

Therefore,

$$625.5\text{ mW} - 400\text{ mW} = 225.5\text{ mW}$$

Power Calculation Methodology ($R_{LOAD} = 0\ \Omega$)

Using the voltage and current values in Table 55, the total quiescent current power is 19.18 mW.

Next,

$$(V_{DPC+}) \times (20\text{ mA} + I_{DPC+}) = 4.95\text{ V} \times 20.5\text{ mA} = 101.5\text{ mW}$$

Assume the dc-to-dc converter at 65% efficiency. Therefore, V_{DPC+} power = 156.2 mW. The total input power at the ADFS5758 side of the ADP1031 is therefore 156.2 mW + 19.18 mW = 175.38 mW. Subtracting the 0 mW load power from this value gives the power associated only with the ADFS5758, which is 175.38 mW.

Assuming an 85% efficiency ADP1031, the total input power becomes 206.33 mW.

$$\text{Total Module Power} = \text{Input Power} - \text{Load Power}$$

Therefore,

$$206.33\text{ mW} - 0\text{ mW} = 206.33\text{ mW}$$

OUTLINE DIMENSIONS

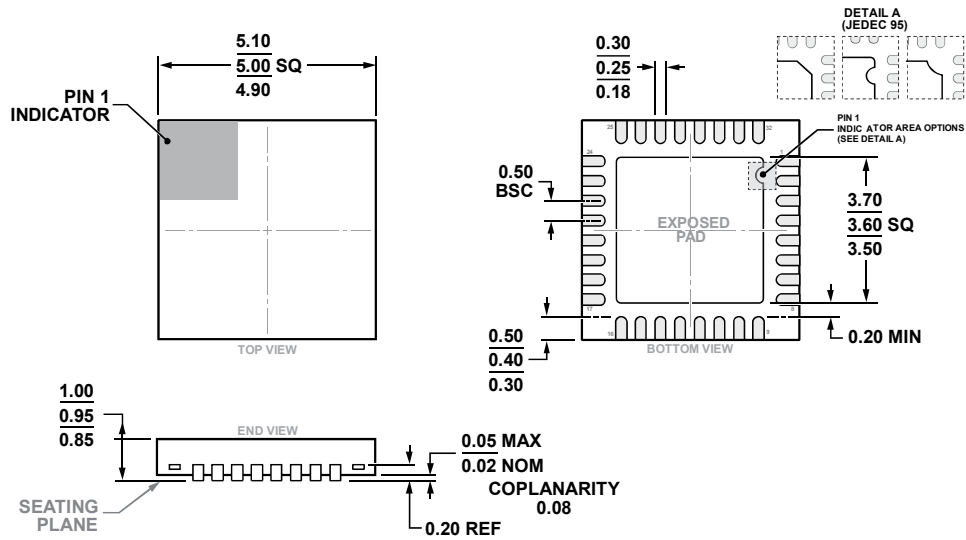

COMPLIANT TO JEDEC STANDARDS MO-220-VHHD-5.

Figure 95. 32-Lead Lead Frame Chip Scale Package [LFCSP]
 5 mm × 5 mm Body and 0.95 mm Package Height
 (CP-32-30)
 Dimensions shown in millimeters

ORDERING GUIDE

Model ^{1, 2}	Temperature Range	Package Description	Package Option
ADFS5758BCPZ-RL7	-40°C to +105°C	32-Lead Lead Frame Chip Scale Package [LFCSP]	CP-32-30
EVAL-ADFS5758SDZ		Evaluation Board	

¹ Z = RoHS Compliant Part.

² USB interface board, [EVAL-SDP-CS1Z](#)

X-ON Electronics

Largest Supplier of Electrical and Electronic Components

Click to view similar products for [Digital to Analog Converters - DAC category](#):

Click to view products by [Analog Devices manufacturer](#):

Other Similar products are found below :

[5962-8871903MYA](#) [5962-8876601LA](#) [AD5311BRMZ-REEL7](#) [AD664AJ](#) [AD7534JPZ](#) [TCC-103A-RT](#) [057536E](#) [5962-89657023A](#)
[702423BB](#) [TCC-202A-RT](#) [AD664BE](#) [TCC-303A-RT](#) [TCC-206A-RT](#) [AD5770RBCBZ-RL7](#) [DAC8229FSZ-REEL](#) [AD5673RBCPZ-2](#)
[MCP48FVB24-20E/ST](#) [MCP48FVB28-E/MQ](#) [MCP48FEB18-20E/ST](#) [MCP48FEB18-E/MQ](#) [MCP48FEB24-E/MQ](#) [MCP47FVB04-20E/ST](#)
[MCP48FEB28T-20E/ST](#) [MCP47FVB04T-E/MQ](#) [MCP48FEB28T-E/MQ](#) [MCP48FVB28T-20E/ST](#) [MCP47FVB28T-20E/ST](#) [MCP47FEB24T-](#)
[E/MQ](#) [MCP48FVB24T-E/MQ](#) [MCP48FVB18T-20E/ST](#) [MCP47FEB14T-E/MQ](#) [MCP48FVB14T-20E/ST](#) [MCP48FEB08T-E/MQ](#)
[MCP47FEB08T-E/MQ](#) [MCP48FVB08T-20E/ST](#) [MCP48FEB04T-20E/ST](#) [MCP47FEB04T-E/MQ](#) [MCP48FVB04T-20E/ST](#) [MCP47FVB04T-](#)
[20E/ST](#) [MCP48CVB18-E/ML](#) [MCP48CVB08-E/ML](#) [MCP47CMB28-E/ML](#) [MCP48CMB18-E/ML](#) [MCP48CVB14-E/ML](#) [MCP48CMB04-](#)
[E/ML](#) [MCP48CMB08-E/ML](#) [MCP47CVB04-E/ML](#) [MCP47CMB14-E/ML](#) [MCP48CMB14-E/ML](#) [MCP48CVB28-20E/ST](#)