

## FEATURES

Operates from 1.65 V to 3.6 V supply rails  
Unidirectional signal path  
Up/down level translation  
Ultracompact 6-lead SOT-23 package  
Output short-circuit protection  
LVTTTL-/CMOS-compatible inputs

## APPLICATIONS

Level translation in

- PDA's
- Handsets
- MP3 players

## GENERAL DESCRIPTION

The ADG3231 is a single-channel level translator designed on a submicron process that is guaranteed to operate over the 1.65 V to 3.6 V supply range. The device can be used in applications requiring communication between digital devices operating from multiple supply voltages. The logic levels on each side of the device are set by the two supply voltages,  $V_{CC1}$  for A and  $V_{CC2}$  for Y. The signal path is unidirectional, meaning data can flow only from A to Y.

The ADG3231 can operate with any combination of  $V_{CC1}$  and  $V_{CC2}$  supply voltages within the 1.65 V to 3.6 V range, allowing the part to perform either up ( $V_{CC1} < V_{CC2}$ ) or down ( $V_{CC1} > V_{CC2}$ ) level translation. The output stage is protected

## FUNCTIONAL BLOCK DIAGRAM

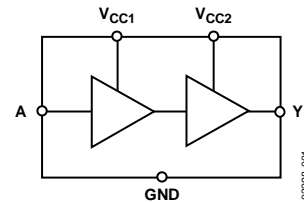

Figure 1.

against current overload, which can occur when the Y pin is accidentally shorted to the  $V_{CC2}$  or GND rails.

The ADG3231 is available in the SOT-23 (2.8 mm × 2.9 mm × 1.3 mm) ultracompact package, making the part ideal for applications where space is critical.

## PRODUCT HIGHLIGHTS

1. Up/down level translation.
2. Guaranteed to operate with any supply combination within the 1.65 V to 3.6 V range.
3. Output short-circuit protection.
4. Available in ultracompact SOT-23 package.

**TABLE OF CONTENTS**

|                                |   |  |    |
|--------------------------------|---|--|----|
| Features .....                 | 1 | Absolute Maximum Ratings .....                     | 4  |
| Applications.....              | 1 | ESD Caution.....                                   | 4  |
| Functional Block Diagram ..... | 1 | Pin Configurations and Function Descriptions ..... | 5  |
| General Description .....      | 1 | Typical Performance Characteristics .....          | 6  |
| Product Highlights .....       | 1 | Theory of Operation .....                          | 9  |
| Revision History .....         | 2 | Outline Dimensions .....                           | 10 |
| Specifications.....            | 3 | Ordering Guide .....                               | 10 |

**REVISION HISTORY**

**9/12—Rev. B to Rev. C**

|   |    |
|---|----|
| Removed SOT-66 Package (Throughout) ..... | 1  |
| Updated Outline Dimensions .....          | 10 |
| Changes to Ordering Guide .....           | 10 |

**5/06—Rev. A to Rev. B**

|                                      |    |
|--------------------------------------|----|
| Deleted Figure 11 and Figure 12..... | 7  |
| Changes to Ordering Guide .....      | 10 |

**12/04—Rev. 0 to Rev. A**

|                                  |           |
|----------------------------------|-----------|
| Updated Format.....              | Universal |
| Added SOT-66 Package .....       | Universal |
| Change to Data Sheet Title ..... | 1         |

**Changes to Features, Applications, General Description**

|   |    |
|---|----|
| and Product Highlights Sections.....        | 1  |
| Changes to Figure 1.....                    | 1  |
| Changes to Table 1.....                     | 3  |
| Changes to Figure 2 and Figure 3.....       | 3  |
| Deleted TPC 1 to TPC 6.....                 | 6  |
| Changes to Figure 13 through Figure 20..... | 7  |
| Changes to Theory of Operation Section..... | 9  |
| Updated Outline Dimensions.....             | 10 |
| Changes to Ordering Guide .....             | 10 |

**5/03—Revision 0: Initial Version**

## SPECIFICATIONS

$V_{CC1} = V_{CC2} = 1.65\text{ V to }3.6\text{ V}$ ,  $GND = 0\text{ V}$ . All specifications  $T_{MIN}$  to  $T_{MAX}$ , unless otherwise noted. Temperature range for the B version is  $-40^{\circ}\text{C}$  to  $+85^{\circ}\text{C}$ .

Table 1.

| Parameter                              | Symbol                | Conditions  | Min              | Typ <sup>1</sup> | Max            | Unit          |
|--|-----------------------|---|------------------|------------------|----------------|---------------|
| LOGIC INPUTS/OUTPUTS                   |                       |   |                  |                  |                |               |
| Input High Voltage <sup>2</sup>        | $V_{IH}$              | $V_{CC1} = 3.0\text{ V to }3.6\text{ V}$                                  | 1.35             |                  |                | V             |
|  |                       | $V_{CC1} = 2.3\text{ V to }2.7\text{ V}$                                  | 1.35             |                  |                | V             |
|  |                       | $V_{CC1} = 1.65\text{ V to }1.95\text{ V}$                                | $0.65 V_{CC1}$   |                  |                | V             |
| Input Low Voltage <sup>2</sup>         | $V_{IL}$              | $V_{CC1} = 3.0\text{ V to }3.6\text{ V}$                                  |                  |                  | 0.8            | V             |
|  |                       | $V_{CC1} = 2.3\text{ V to }2.7\text{ V}$                                  |                  |                  | 0.7            | V             |
|  |                       | $V_{CC1} = 1.65\text{ V to }1.95\text{ V}$                                |                  |                  | $0.35 V_{CC1}$ | V             |
| Output High Voltage                    | $V_{OH}$              | $I_{OH} = -100\ \mu\text{A}$ , $V_{CC2} = 3.0\text{ V to }3.6\text{ V}$   | 2.4              |                  |                | V             |
|  |                       | $I_{OH} = -100\ \mu\text{A}$ , $V_{CC2} = 2.3\text{ V to }2.7\text{ V}$   | 2.0              |                  |                | V             |
|  |                       | $I_{OH} = -100\ \mu\text{A}$ , $V_{CC2} = 1.65\text{ V to }1.95\text{ V}$ | $V_{CC2} - 0.45$ |                  |                | V             |
|  |                       | $I_{OH} = -4\text{ mA}$ , $V_{CC2} = 2.3\text{ V to }2.7\text{ V}$        | 2.0              |                  |                | V             |
|  |                       | $I_{OH} = -4\text{ mA}$ , $V_{CC2} = 1.65\text{ V to }1.95\text{ V}$      | $V_{CC2} - 0.45$ |                  |                | V             |
|  |                       | $I_{OH} = -8\text{ mA}$ , $V_{CC2} = 3.0\text{ V to }3.6\text{ V}$        | 2.4              |                  |                | V             |
| Output Low Voltage                     | $V_{OL}$              | $I_{OL} = 100\ \mu\text{A}$ , $V_{CC2} = 3.0\text{ V to }3.6\text{ V}$    |                  |                  | 0.4            | V             |
|  |                       | $I_{OL} = 100\ \mu\text{A}$ , $V_{CC2} = 2.3\text{ V to }2.7\text{ V}$    |                  |                  | 0.4            | V             |
|  |                       | $I_{OL} = 100\ \mu\text{A}$ , $V_{CC2} = 1.65\text{ V to }1.95\text{ V}$  |                  |                  | 0.45           | V             |
|  |                       | $I_{OL} = 4\text{ mA}$ , $V_{CC2} = 2.3\text{ V to }2.7\text{ V}$         |                  |                  | 0.4            | V             |
|  |                       | $I_{OL} = 4\text{ mA}$ , $V_{CC2} = 1.65\text{ V to }1.95\text{ V}$       |                  |                  | 0.45           | V             |
|  |                       | $I_{OL} = 8\text{ mA}$ , $V_{CC2} = 3.0\text{ V to }3.6\text{ V}$         |                  |                  | 0.4            | V             |
| SWITCHING CHARACTERISTICS <sup>2</sup> |                       |   |                  |                  |                |               |
| Propagation Delay, $t_{PD}$ A to Y     | $t_{PHL}$ , $t_{PLH}$ | $3.3\text{ V} \pm 0.3\text{ V}$ , $C_L = 30\text{ pF}$ , see Figure 2     |                  | 4                | 6.5            | ns            |
| Propagation Delay, $t_{PD}$ A to Y     | $t_{PHL}$ , $t_{PLH}$ | $2.5\text{ V} \pm 0.2\text{ V}$ , $C_L = 30\text{ pF}$ , see Figure 2     |                  | 4.5              | 6.5            | ns            |
| Propagation Delay, $t_{PD}$ A to Y     | $t_{PHL}$ , $t_{PLH}$ | $1.8\text{ V} \pm 0.15\text{ V}$ , $C_L = 30\text{ pF}$ , see Figure 2    |                  | 6.5              | 10.25          | ns            |
| Input Leakage Current                  | $I_I$                 | $0 \leq V_{IN} \leq 3.6\text{ V}$   |                  |                  | $\pm 1$        | $\mu\text{A}$ |
| Output Leakage Current                 | $I_O$                 | $0 \leq V_{IN} \leq 3.6\text{ V}$   |                  |                  | $\pm 1$        | $\mu\text{A}$ |
| POWER REQUIREMENTS                     |                       |   |                  |                  |                |               |
| Power Supply Voltages                  | $V_{CC1}$             |   | 1.65             |                  | 3.6            | V             |
|  | $V_{CC2}$             |   | 1.65             |                  | 3.6            | V             |
| Quiescent Power Supply Current         | $I_{CC1}$             | Digital inputs = $0\text{ V}$ or $V_{CC1}$                                |                  |                  | 2              | $\mu\text{A}$ |
|  | $I_{CC2}$             | Digital inputs = $0\text{ V}$ or $V_{CC2}$                                |                  |                  | 2              | $\mu\text{A}$ |

<sup>1</sup> All typical values are at  $V_{CC1} = V_{CC2}$ ,  $T_A = 25^{\circ}\text{C}$ , unless otherwise noted.

<sup>2</sup> Guaranteed by design, not subject to production test.

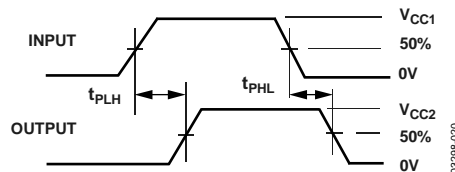

Figure 2. Timing Diagram

## ABSOLUTE MAXIMUM RATINGS

$T_A = 25^\circ\text{C}$ , unless otherwise noted.

**Table 2.**

| Parameter   | Rating                      |
|---|-----------------------------|
| $V_{CC}$ to GND                                       | -0.3 V to +4.6 V            |
| Input Voltage for A                                   | -0.3 V to $V_{CC1} + 0.3$ V |
| DC Output Current                                     | 25 mA                       |
| Operating Temperature Range<br>Industrial (B Version) | -40°C to +85°C              |
| Storage Temperature Range                             | -65°C to +150°C             |
| Junction Temperature                                  | 150°C                       |
| $\theta_{JA}$ Thermal Impedance<br>6-Lead SOT-23      | 229°C/W                     |
| Lead Temperature, Soldering (10 sec)                  | 300°C                       |
| IR Reflow, Peak Temperature (<20 sec)                 | 235°C                       |

Stresses above those listed under Absolute Maximum Ratings may cause permanent damage to the device. This is a stress rating only; functional operation of the device at these or any other conditions above those indicated in the operational section of this specification is not implied. Exposure to absolute maximum rating conditions for extended periods may affect device reliability.

Only one absolute maximum rating may be applied at any one time.

### ESD CAUTION



**ESD (electrostatic discharge) sensitive device.** Charged devices and circuit boards can discharge without detection. Although this product features patented or proprietary protection circuitry, damage may occur on devices subjected to high energy ESD. Therefore, proper ESD precautions should be taken to avoid performance degradation or loss of functionality.

## PIN CONFIGURATIONS AND FUNCTION DESCRIPTIONS

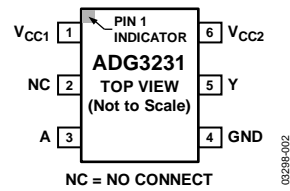

Figure 3. SOT-23

Table 3. Pin Function Descriptions

| Pin Number | Mnemonic         | Description   |
|------------|------------------|---|
| 1          | V <sub>CC1</sub> | Supply Voltage 1. Can be any supply voltage from 1.65 V to 3.6 V. |
| 2          | NC               | Not internally connected.   |
| 3          | A                | Digital Input Referred to V <sub>CC1</sub> .                      |
| 4          | GND              | Device Ground Pin.  |
| 5          | Y                | Digital Output Referred to V <sub>CC2</sub> .                     |
| 6          | V <sub>CC2</sub> | Supply Voltage 2. Can be any supply voltage from 1.65 V to 3.6 V. |

TYPICAL PERFORMANCE CHARACTERISTICS

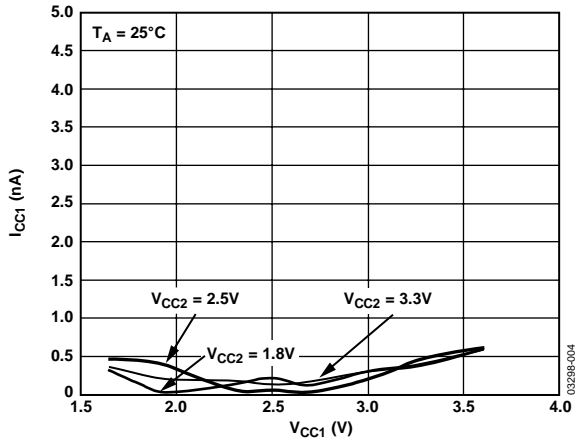

Figure 4.  $I_{CC1}$  vs.  $V_{CC1}$

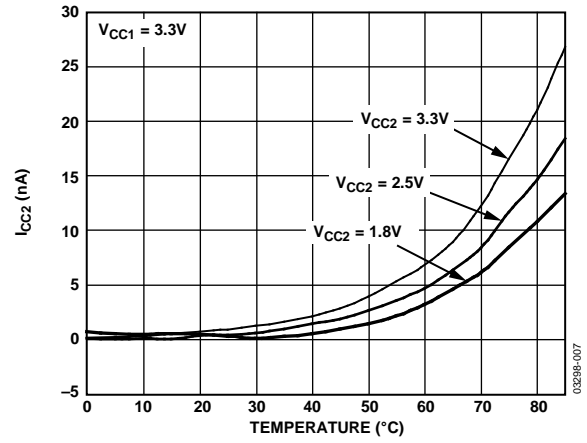

Figure 7.  $I_{CC2}$  vs. Temperature

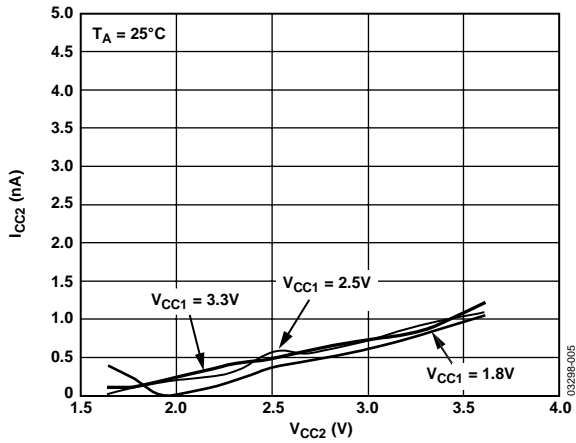

Figure 5.  $I_{CC2}$  vs.  $V_{CC2}$

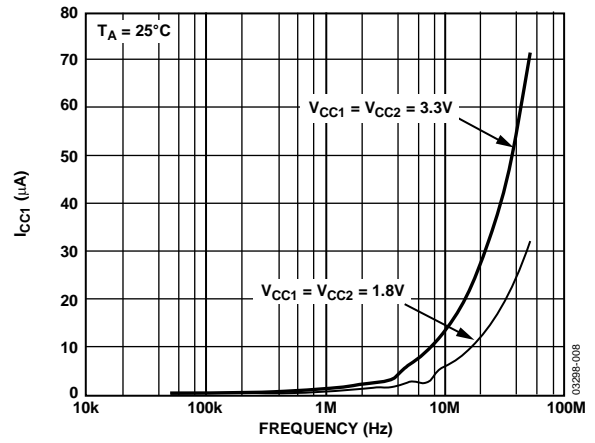

Figure 8.  $I_{CC1}$  vs. Frequency

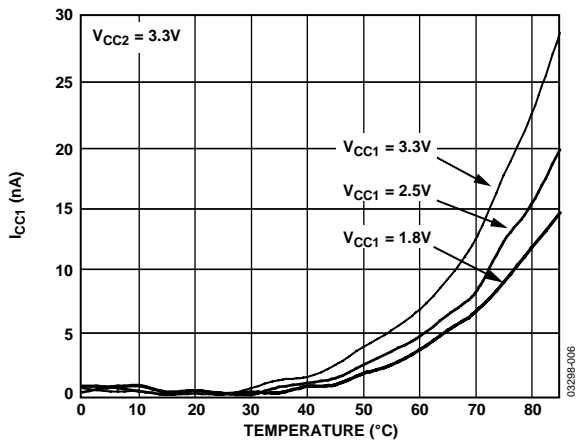

Figure 6.  $I_{CC1}$  vs. Temperature

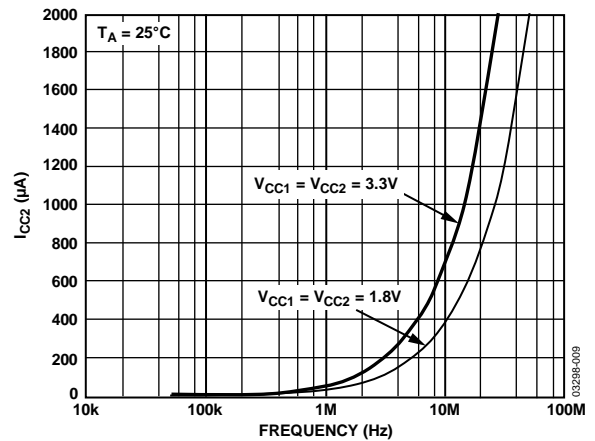

Figure 9.  $I_{CC2}$  vs. Frequency

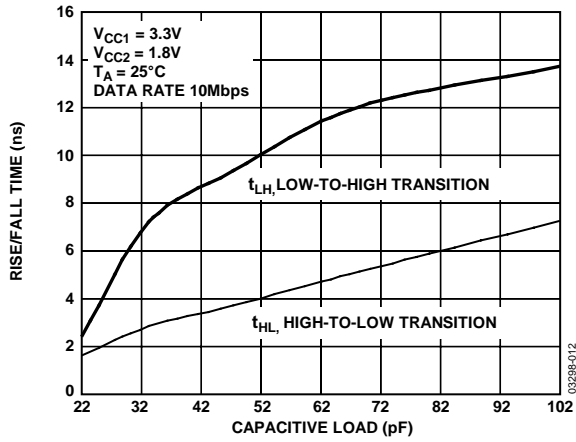

Figure 10. Rise/Fall Time vs. Capacitive Load (3.3 V to 1.8 V Level Translation)

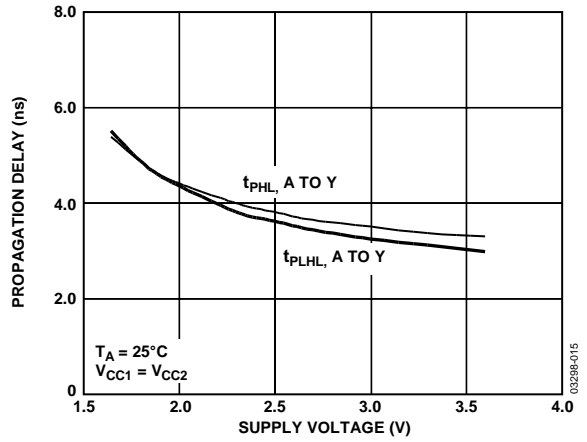

Figure 13. Propagation Delay vs. Supply Voltage

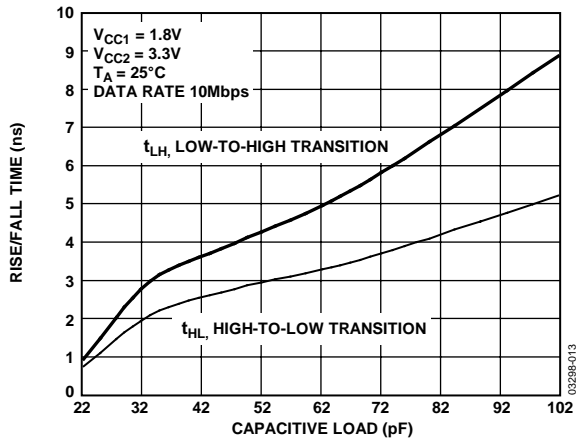

Figure 11. Rise/Fall Time vs. Capacitive Load (1.8 V to 3.3 V Level Translation)

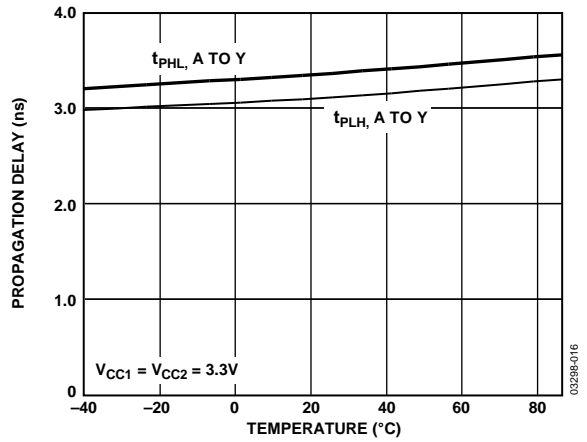

Figure 14. Propagation Delay vs. Temperature

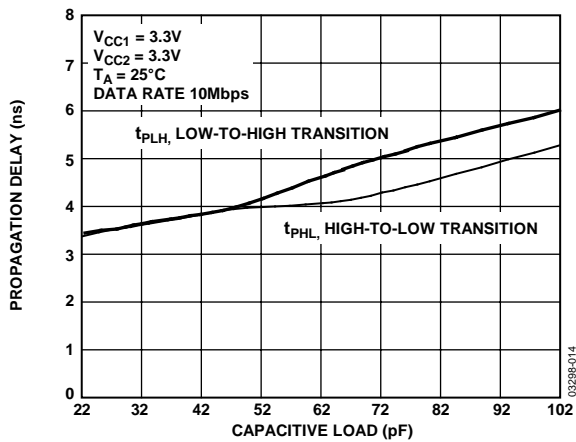

Figure 12. Propagation Delay vs. Capacitive Load

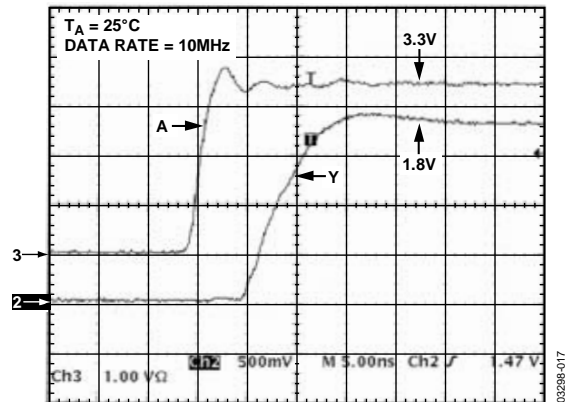

Figure 15. Input/Output  $V_{CC1} = 3.3V$ ,  $V_{CC2} = 1.8V$

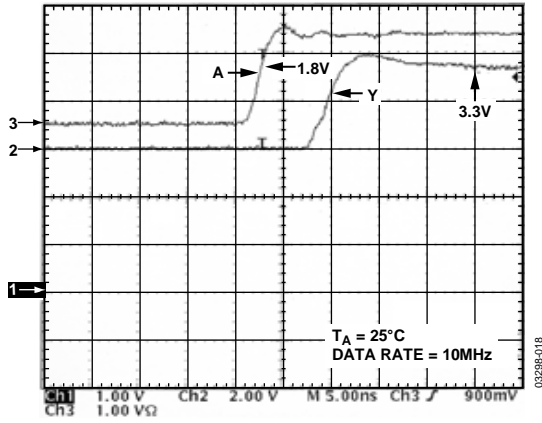

Figure 16. Input/Output  $V_{CC1} = 1.8\text{ V}$ ,  $V_{CC2} = 3.3\text{ V}$

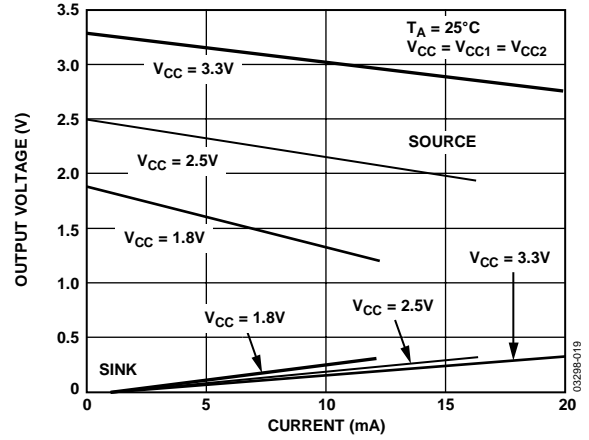

Figure 17. Output Voltage vs. Sink and Source Current



## THEORY OF OPERATION

The ADG3231 is a single-channel level translator designed on a submicron process that is guaranteed to operate over the 1.65 V to 3.6 V supply range. The device can be used in applications requiring communication between digital devices operating from multiple supply voltages. The logic levels on each side of the device are set by the two supply voltages,  $V_{CC1}$  for A, and  $V_{CC2}$  for Y. The signal path is unidirectional, meaning data can flow only from A to Y.

The ADG3231 can operate with any combination of  $V_{CC1}$  and  $V_{CC2}$  supply voltages within the 1.65 V to 3.6 V range, allowing the part to perform either up ( $V_{CC1} < V_{CC2}$ ) or down ( $V_{CC1} > V_{CC2}$ ) level translation.

By limiting the current delivered into the load, for example,  $\sim 1.7$  mA with  $V_{CC2} = 3.6$  V, the output stage is protected against current overload, which can occur when the Y pin is accidentally shorted to the  $V_{CC2}$  or GND rails.

The short-circuit protection circuitry works by limiting the output current when the output voltage exceeds  $V_{OL}$  ( $A = 0$  logic) or is less than  $V_{OH}$  ( $A = 1$  logic) threshold values specified for the  $V_{CC2}$  supply voltage used.

Figure 18 shows a typical application for the ADG3231 where the device performs level translation from  $V_{CC1}$ -compatible levels to  $V_{CC2}$ -compatible levels to allow proper communication between the two digital devices, DEVICE 1 and DEVICE 2.

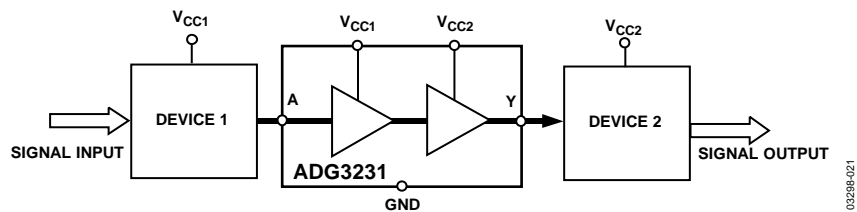
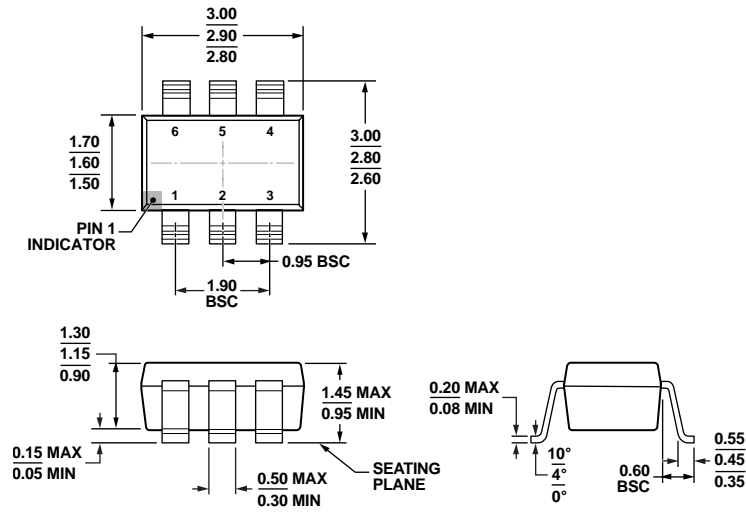

Figure 18. Typical Application of the ADG3231 Level Translator

OUTLINE DIMENSIONS



12-16-2005-A

COMPLIANT TO JEDEC STANDARDS MO-178-AB  
 Figure 19. 6-Lead Small Outline Transistor Package [SOT-23]  
 (RJ-6)  
 Dimensions shown in millimeters

ORDERING GUIDE

| Model <sup>1</sup> | Temperature Range | Package Description | Package Option | Branding |
|--------------------|-------------------|---------------------|----------------|----------|
| ADG3231BRJ-REEL7   | -40°C to +85°C    | 6-Lead SOT-23       | RJ-6           | W2B      |
| ADG3231BRJZ-REEL   | -40°C to +85°C    | 6-Lead SOT-23       | RJ-6           | W2B #    |
| ADG3231BRJZ-REEL7  | -40°C to +85°C    | 6-Lead SOT-23       | RJ-6           | W2B #    |

<sup>1</sup> Z = RoHS Compliant Part, # denotes lead-free may be top or bottom marked.

**NOTES**

**NOTES**

## X-ON Electronics

Largest Supplier of Electrical and Electronic Components

*Click to view similar products for [Translation - Voltage Levels](#) category:*

*Click to view products by [Analog Devices](#) manufacturer:*

Other Similar products are found below :

[NLSX4373DMR2G](#) [NLSX5012MUTAG](#) [NLSX0102FCT2G](#) [NLSX4302EBMUTCG](#) [PCA9306FMUTAG](#) [MC100EPT622MNG](#)  
[NLSX3014MUTAG](#) [NLSV4T244EMUTAG](#) [NLSX5011MUTCG](#) [NLV9306USG](#) [NLV SX4014MUTAG](#) [NLSV4T3144MUTAG](#)  
[NLV SX4373MUTAG](#) [NB3U23CMNTAG](#) [MAX3371ELT+T](#) [NLSX3013BFCT1G](#) [NLV7WBD3125USG](#) [NLSX3012DMR2G](#)  
[74AVCH1T45FZ4-7](#) [NLVSV1T244MUTBG](#) [74AVC1T45GS-Q100H](#) [CLVC16T245MDGGREP](#) [MC10H124FNG](#)  
[CAVCB164245MDGGREP](#) [CD40109BPWR](#) [MC10H350FNG](#) [MC10H125FNG](#) [MC100EPT21MNR4G](#) [MC100EP91DWG](#)  
[NLSV2T244MUTAG](#) [NLSX3013FCT1G](#) [NLSX5011AMX1TCG](#) [PCA9306USG](#) [SN74AVCA406LZQSR](#) [NLSX4014DTR2G](#)  
[NLSX3018DTR2G](#) [LTC1045CSW#PBF](#) [LTC1045CN#PBF](#) [SY100EL92ZG](#) [74AXP1T34GMH](#) [74AXP1T34GNH](#) [PI4ULS3V204LE](#)  
[ADG3245BRUZ-REEL7](#) [ADG3123BRUZ](#) [ADG3245BRUZ](#) [ADG3246BCPZ](#) [ADG3308BCPZ-REEL](#) [ADG3233BRJZ-REEL7](#)  
[ADG3233BRMZ](#) [ADG3241BKSZ-500RL7](#)