

FEATURES

Low on resistance, 2.5 Ω maximum
 <0.65 Ω on-resistance flatness
 Dual ±2.7 V to ±5.5 V or single +2.7 V to +5.5 V supplies
 Rail-to-rail input signal range
 Tiny, 6-lead SOT-23; 8-lead MSOP; and 820 μm × 2255 μm die
 Low power consumption
 TTL-/CMOS-compatible inputs

APPLICATIONS

Automatic test equipment
 Power routing
 Communication systems
 Data acquisition systems
 Sample-and-hold systems
 Avionics
 Relay replacement
 Battery-powered systems

GENERAL DESCRIPTION

The [ADG601/ADG602](#) are monolithic, CMOS single-pole single-throw (SPST) switches with on resistance typically less than 2.5 Ω. The low on-resistance flatness makes the [ADG601/ADG602](#) ideally suited to many applications, particularly those requiring low distortion. These switches are ideal replacements for mechanical relays because they are more reliable, have lower power requirements, and are available in much smaller package sizes.

The [ADG601](#) is a normally open (NO) switch, and the [ADG602](#) is a normally closed (NC) switch. Each switch conducts equally well in both directions when the device is on, with the input signal range extending to the supply rails.

The switches are available in tiny, 6-lead SOT-23; 8-lead MSOP; and 820 μm × 2255 μm die.

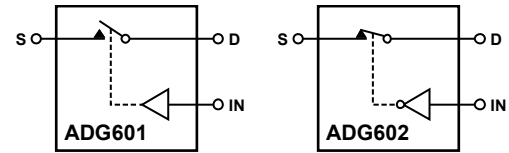
FUNCTIONAL BLOCK DIAGRAMS

NOTES
 1. SWITCHES SHOWN FOR A LOGIC 0 INPUT.

Figure 1.

02619-001

Table 1. Truth Table

ADG601 IN	ADG602 IN	Switch Condition
0	1	Off
1	0	On

PRODUCT HIGHLIGHTS

1. Low on resistance (2 Ω typical)
2. Dual ±2.7 V to ±5.5 V or single +2.7 V to +5.5 V supplies
3. Tiny, 6-lead SOT-23; 8-lead MSOP; and 820 μm × 2255 μm die
4. Rail-to-rail input signal range

TABLE OF CONTENTS

Features	1	Absolute Maximum Ratings	5
Applications.....	1	ESD Caution.....	5
Functional Block Diagrams.....	1	Pin Configurations and Function Descriptions	6
General Description	1	Typical Performance Characteristics	7
Product Highlights	1	Terminology	9
Revision History	2	Test Circuits.....	10
Specifications.....	3	Outline Dimensions	11
Dual Supply	3	Ordering Guide	12
Single Supply	4		

REVISION HISTORY

3/15—Rev. C to Rev. D

Changes to IR Reflow, Peak Temperature Parameter, Table 4	5
Updated Outline Dimensions	11
Changes to Ordering Guide	12

3/07—Rev. B to Rev. C

Added Die Package.....	Universal
Changes to Specifications	3
Added Figure 4 and Table 6.....	6
Changes to Ordering Guide	11

3/06—Rev. A to Rev. B

Updated Format.....	Universal
Changes to 6-Lead SOT-23 (RJ-6) Pin Configuration	6
Added Pin Function Descriptions Table	6
Changes to Figure 19.....	9
Updated Outline Dimensions.....	11
Changes to Ordering Guide	11

6/03—Rev. 0 to Rev. A

Changes to Specifications.....	2
Changes to Ordering Guide	4
Updated Outline Dimensions.....	8

11/01—Revision 0: Initial Version

SPECIFICATIONS

DUAL SUPPLY

$V_{DD} = 5\text{ V} \pm 10\%$, $V_{SS} = -5\text{ V} \pm 10\%$, $GND = 0\text{ V}$, unless otherwise noted.

Table 2.

Parameter	B Version ¹		Unit	Test Conditions/Comments
	+25°C	-40°C to +85°C		
ANALOG SWITCH				
Analog Signal Range		V_{SS} to V_{DD}	V	$V_{DD} = +4.5\text{ V}$, $V_{SS} = -4.5\text{ V}$
On Resistance (R_{ON})	2		Ω typ	$V_S = \pm 4.5\text{ V}$, $I_{DS} = -10\text{ mA}$; see Figure 15
	2.5	5.5	Ω max	
On-Resistance Flatness ($R_{FLAT(ON)}$)	0.35	0.4	Ω typ	$V_S = \pm 3.3\text{ V}$, $I_{DS} = -10\text{ mA}$
	0.6	0.65	Ω max	
LEAKAGE CURRENTS				
Source Off Leakage, I_S (Off)	± 0.01		nA typ	$V_{DD} = +5.5\text{ V}$, $V_{SS} = -5.5\text{ V}$
	± 0.25	± 1	nA max	$V_S = +4.5\text{ V}/-4.5\text{ V}$, $V_D = -4.5\text{ V}/+4.5\text{ V}$; see Figure 16
Drain Off Leakage, I_D (Off)	± 0.01		nA typ	$V_S = +4.5\text{ V}/-4.5\text{ V}$, $V_D = -4.5\text{ V}/+4.5\text{ V}$; see Figure 16
	± 0.25	± 1	nA max	
Channel On Leakage, I_D , I_S (On)	± 0.01		nA typ	$V_S = V_D = +4.5\text{ V}$ or -4.5 V ; see Figure 17
	± 0.25	± 1	nA max	
DIGITAL INPUTS				
Input High Voltage, V_{INH}		2.4	V min	
Input Low Voltage, V_{INL}		0.8	V max	
Input Current, I_{INL} or I_{INH}	0.005		μA typ	$V_{IN} = V_{INL}$ or V_{INH}
		± 0.1	μA max	
Digital Input Capacitance, C_{IN}	2		pF typ	
DYNAMIC CHARACTERISTICS²				
t_{ON}	80		ns typ	$R_L = 300\ \Omega$, $C_L = 35\text{ pF}$
	120	155	ns max	$V_S = 3.3\text{ V}$; see Figure 18
t_{OFF}	45		ns typ	$R_L = 300\ \Omega$, $C_L = 35\text{ pF}$
	75	90	ns max	$V_S = 3.3\text{ V}$; see Figure 18
Charge Injection	250		pC typ	$V_S = 0\text{ V}$, $R_S = 0\ \Omega$, $C_L = 1\text{ nF}$; see Figure 19
Off Isolation	-60		dB typ	$R_L = 50\ \Omega$, $C_L = 5\text{ pF}$, $f = 1\text{ MHz}$; see Figure 20
Bandwidth -3 dB	180		MHz typ	$R_L = 50\ \Omega$, $C_L = 5\text{ pF}$; see Figure 21
C_S (Off)	50		pF typ	$f = 1\text{ MHz}$
C_D (Off)	50		pF typ	$f = 1\text{ MHz}$
C_D , C_S (On)	145		pF typ	$f = 1\text{ MHz}$
POWER REQUIREMENTS				
I_{DD}	0.001		μA typ	$V_{DD} = +5.5\text{ V}$, $V_{SS} = -5.5\text{ V}$
		1.0	μA max	Digital inputs = 0 V or 5.5 V
I_{SS}	0.001		μA typ	Digital inputs = 0 V or 5.5 V
		1.0	μA max	

¹ Temperature range for B version is -40°C to +85°C.

² Guaranteed by design, not subject to production test.

SINGLE SUPPLY

$V_{DD} = 5\text{ V} \pm 10\%$, $V_{SS} = 0\text{ V}$, $GND = 0\text{ V}$, unless otherwise noted.

Table 3.

Parameter	B Version ¹		Unit	Test Conditions/Comments
	+25°C	−40°C to +85°C		
ANALOG SWITCH				
Analogue Signal Range		0 V to V_{DD}	V	$V_{DD} = 4.5\text{ V}$
On Resistance (R_{ON})	3.5		Ω typ	$V_S = 0\text{ V to }4.5\text{ V}$, $I_{DS} = -10\text{ mA}$; see Figure 15
	5	8	Ω max	
On-Resistance Flatness ($R_{FLAT(ON)}$)	0.2	0.2	Ω typ	$V_S = 1.5\text{ V to }3.3\text{ V}$, $I_{DS} = -10\text{ mA}$
		0.6	Ω max	
LEAKAGE CURRENTS				
Source Off Leakage, I_S (Off)	± 0.01		nA typ	$V_{DD} = 5.5\text{ V}$
	± 0.25	± 1	nA max	$V_S = 4.5\text{ V/1 V}$, $V_D = 1\text{ V/4.5 V}$; see Figure 16
Drain Off Leakage, I_D (Off)	± 0.01		nA typ	$V_S = 4.5\text{ V/1 V}$, $V_D = 1\text{ V/4.5 V}$; see Figure 16
	± 0.25	± 1	nA max	
Channel On Leakage, I_D , I_S (On)	± 0.01		nA typ	$V_S = V_D = 4.5\text{ V or }1\text{ V}$; see Figure 17
	± 0.25	± 1	nA max	
DIGITAL INPUTS				
Input High Voltage, V_{INH}		2.4	V min	
Input Low Voltage, V_{INL}		0.8	V max	
Input Current, I_{INL} or I_{INH}	0.005		μA typ	$V_{IN} = V_{INL}$ or V_{INH}
		± 0.1	μA max	
Digital Input Capacitance, C_{IN}	2		pF typ	
DYNAMIC CHARACTERISTICS²				
t_{ON}	110		ns typ	$R_L = 300\ \Omega$, $C_L = 35\text{ pF}$
	220	280	ns max	$V_S = 3.3\text{ V}$; see Figure 18
t_{OFF}	50		ns typ	$R_L = 300\ \Omega$, $C_L = 35\text{ pF}$
	80	110	ns max	$V_S = 3.3\text{ V}$; see Figure 18
Charge Injection	20		pC typ	$V_S = 0\text{ V}$, $R_S = 0\ \Omega$, $C_L = 1\text{ nF}$; see Figure 19
Off Isolation	−60		dB typ	$R_L = 50\ \Omega$, $C_L = 5\text{ pF}$, $f = 1\text{ MHz}$; see Figure 20
Bandwidth −3 dB	180		MHz typ	$R_L = 50\ \Omega$, $C_L = 5\text{ pF}$; see Figure 21
C_S (Off)	50		pF typ	$f = 1\text{ MHz}$
C_D (Off)	50		pF typ	$f = 1\text{ MHz}$
C_D , C_S (On)	145		pF typ	$f = 1\text{ MHz}$
POWER REQUIREMENTS				
I_{DD}	0.001		μA typ	$V_{DD} = 5.5\text{ V}$
		1.0	μA max	Digital inputs = 0 V or 5.5 V

¹ Temperature range for B version is -40°C to $+85^\circ\text{C}$.

² Guaranteed by design, not subject to production test.

ABSOLUTE MAXIMUM RATINGS

$T_A = 25^\circ\text{C}$, unless otherwise noted.

Table 4.

Parameter	Rating
V_{DD} to V_{SS}	13 V
V_{DD} to GND	-0.3 V to +6.5 V
V_{SS} to GND	+0.3 V to -6.5 V
Analog Inputs ¹	$V_{SS} - 0.3\text{ V}$ to $V_{DD} + 0.3\text{ V}$
Digital Inputs ¹	-0.3 V to $V_{DD} + 0.3\text{ V}$ or 30 mA (whichever occurs first)
Continuous Current, S or D	100 mA
Peak Current, S or D (Pulsed at 1 ms, 10% Duty Cycle Max)	200 mA
Operating Temperature Range Industrial (B Version)	-40°C to +85°C
Storage Temperature Range	-65°C to +150°C
Junction Temperature	150°C
Thermal Resistance	
MSOP	
θ_{JA}	206°C/W
θ_{JC}	44°C/W
SOT-23	
θ_{JA}	229.6°C/W
θ_{JC}	91.99°C/W
Lead Temperature, Soldering (10 sec)	300°C
IR Reflow, Peak Temperature	260°C

¹ Overvoltages at IN, S, or D are clamped by internal diodes. Current should be limited to the maximum ratings given.

Stresses at or above those listed under Absolute Maximum Ratings may cause permanent damage to the product. This is a stress rating only; functional operation of the product at these or any other conditions above those indicated in the operational section of this specification is not implied. Operation beyond the maximum operating conditions for extended periods may affect product reliability.

Only one absolute maximum rating may be applied at a time.

ESD CAUTION



ESD (electrostatic discharge) sensitive device.

Charged devices and circuit boards can discharge without detection. Although this product features patented or proprietary protection circuitry, damage may occur on devices subjected to high energy ESD. Therefore, proper ESD precautions should be taken to avoid performance degradation or loss of functionality.

PIN CONFIGURATIONS AND FUNCTION DESCRIPTIONS

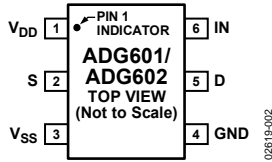

Figure 2. 6-Lead SOT-23 (RJ-6)

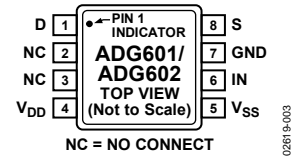

Figure 3. 8-Lead MSOP (RM-8)

Table 5. Pin Function Descriptions

Pin No.		Mnemonic	Description
6-Lead SOT-23	8-Lead MSOP		
1	4	V _{DD}	Most Positive Power Supply Potential.
2	8	S	Source Terminal. Can be an input or output.
3	5	V _{SS}	Most Negative Power Supply Potential.
4	7	GND	Ground (0 V) Reference.
5	1	D	Drain Terminal. Can be an input or output.
6	6	IN	Logic Control Input.
N/A ¹	2, 3	NC	No Connect.

¹ N/A is not applicable.

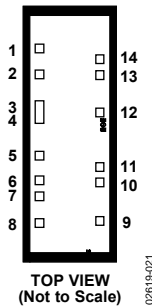

Figure 4. Die (820 μm × 2255 μm)

Table 6. Die Pad Coordinates¹

Die Pad No.	Die Pad Coordinates		Mnemonic	Description
	X (μm)	Y (μm)		
1	-265	+754	NC	No Connect.
2	-265	+525	D	Drain Terminal. Can be an input or output. ²
3	-265	+241	D	Drain Terminal. Can be an input or output. ²
4	-265	+141	D	Drain Terminal. Can be an input or output. ²
5	-265	-191	NC	No Connect.
6	-265	-409	NC	No Connect.
7	-265	-549	NC	No Connect.
8	-265	-787	V _{DD}	Most Positive Power Supply Potential.
9	+265	-767	V _{SS}	Most Negative Power Supply Potential.
10	+265	-429	IN	Logic Control Input.
11	+265	-289	GND	Ground (0 V) Reference.
12	+265	+189	S	Source Terminal. Can be an input or output. ³
13	+265	+521	S	Source Terminal. Can be an input or output. ³
14	+265	+661	NC	Source Terminal. Can be an input or output.

¹ Measured from the center of the die.

² Bond the D pads together to a single point to preserve the on resistance and current handling capability. The common point acts as the drain pin of the switch.

³ Bond the S pads together to a single point to preserve the on resistance and current handling capability. The common point acts as the source pin of the switch.

TYPICAL PERFORMANCE CHARACTERISTICS

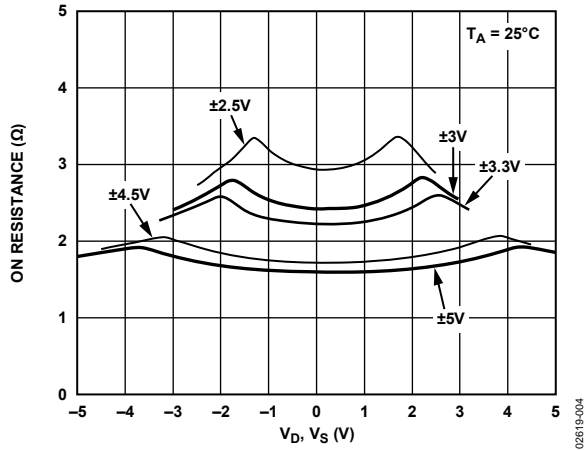

Figure 5. On Resistance vs. V_D , V_S (Dual Supply)

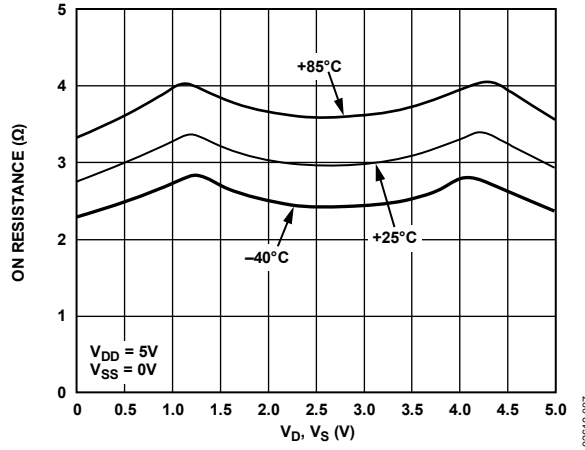

Figure 8. On Resistance vs. V_D , V_S for Different Temperatures (Single Supply)

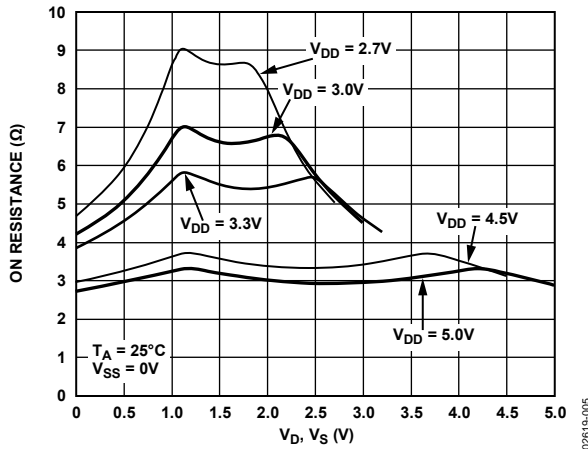

Figure 6. On Resistance vs. V_D , V_S (Single Supply)

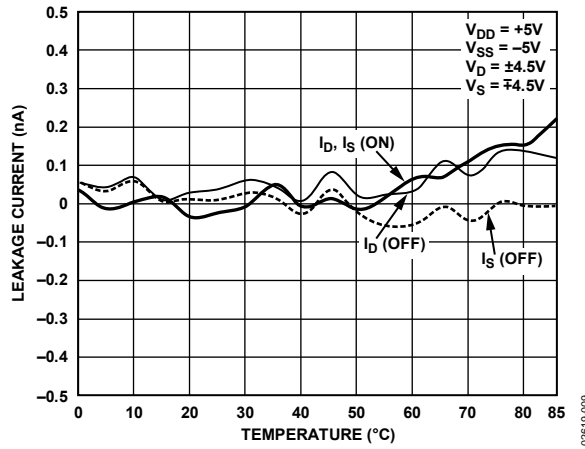

Figure 9. Leakage Currents vs. Temperature (Dual Supply)

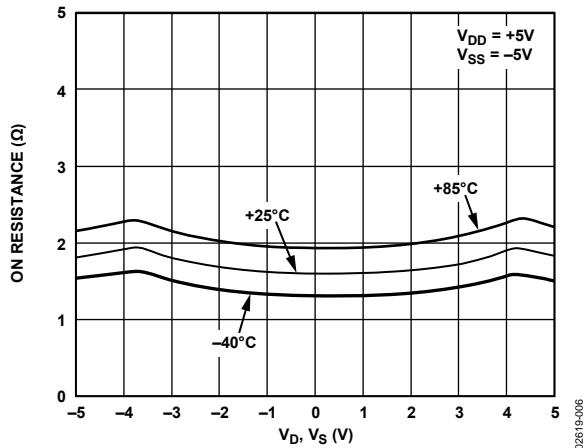

Figure 7. On Resistance vs. V_D , V_S for Different Temperatures (Dual Supply)

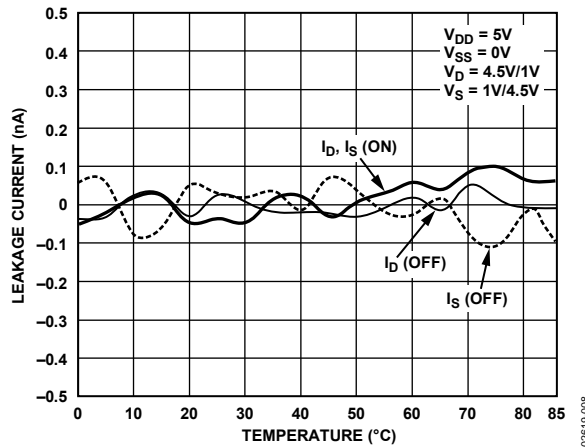

Figure 10. Leakage Currents vs. Temperature (Single Supply)

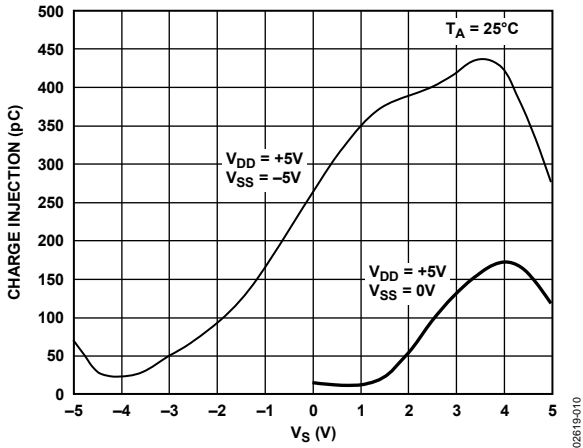

Figure 11. Charge Injection vs. Source Voltage

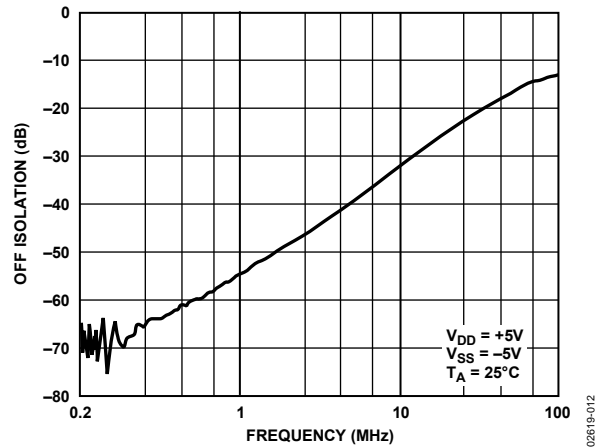

Figure 13. Off Isolation vs. Frequency

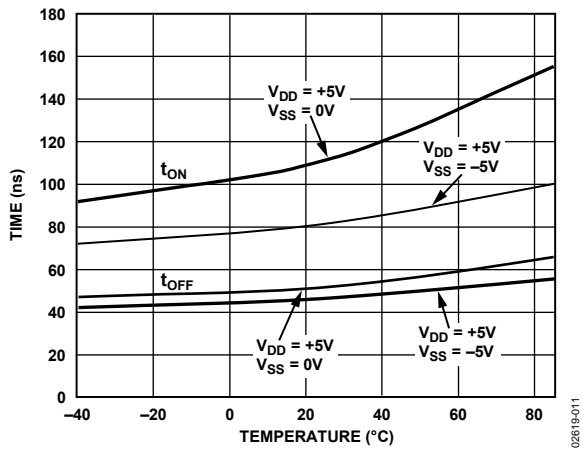

Figure 12. t_{ON}/t_{OFF} Times vs. Temperature

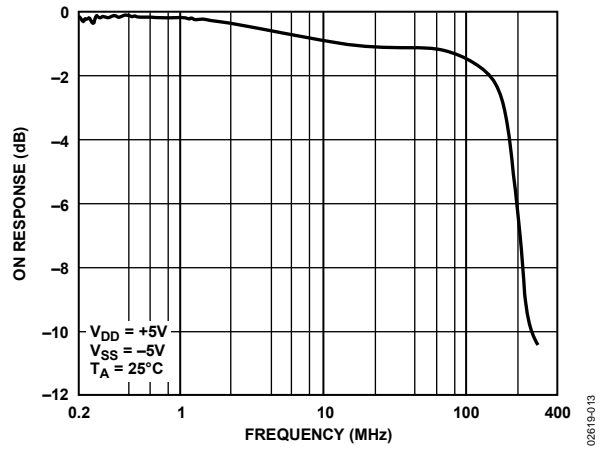

Figure 14. On Response vs. Frequency

TERMINOLOGY

V_{DD}

Most positive power supply potential.

V_{SS}

Most negative power supply potential.

I_{DD}

Positive supply current.

I_{SS}

Negative supply current.

GND

Ground (0 V) reference.

S

Source terminal. Can be an input or an output.

D

Drain terminal. Can be an input or an output.

IN

Logic control input.

V_D, V_S

Analog voltage on Terminal D and Terminal S.

R_{ON}

Ohmic resistance between Terminal D and Terminal S.

$R_{FLAT (ON)}$

Flatness is defined as the difference between the maximum and minimum values of on resistance as measured over the specified analog signal range.

$I_S (Off)$

Source leakage current with the switch off.

$I_D (Off)$

Drain leakage current with the switch off.

$I_D, I_S (On)$

Channel leakage current with the switch on.

V_{INL}

Maximum input voltage for Logic 0.

V_{INH}

Minimum input voltage for Logic 1.

$I_{INL} (I_{INH})$

Input current of the digital input.

$C_S (Off)$

Off switch source capacitance. Measured with reference to ground.

$C_D (Off)$

Off switch drain capacitance. Measured with reference to ground.

$C_D, C_S (On)$

On switch capacitance. Measured with reference to ground.

C_{IN}

Digital input capacitance.

t_{ON}

Delay between applying the digital control input and the output switching on.

t_{OFF}

Delay between applying the digital control input and the output switching off.

Charge Injection

A measure of the glitch impulse transferred from the digital input to the analog output during switching.

Off Isolation

A measure of unwanted signal coupling through an off switch.

On Response

Frequency response of the on switch.

Insertion Loss

Loss due to the on resistance of the switch.

TEST CIRCUITS

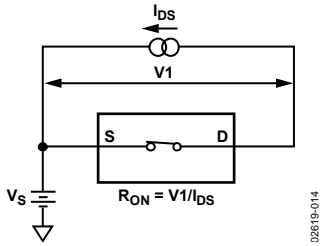

Figure 15. On Resistance

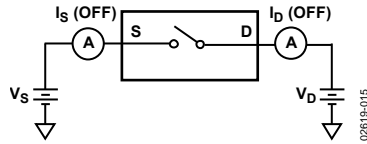

Figure 16. Off Leakage

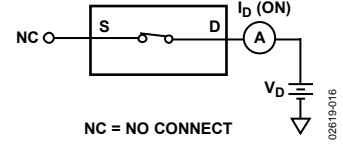

Figure 17. On Leakage

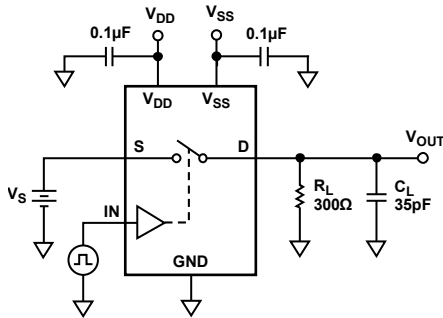

Figure 18. Switching Times

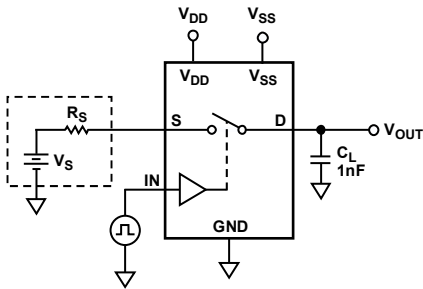
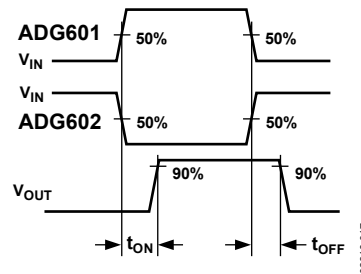
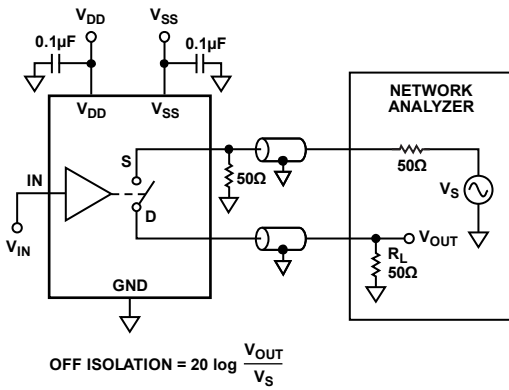
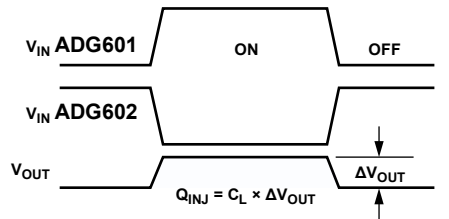
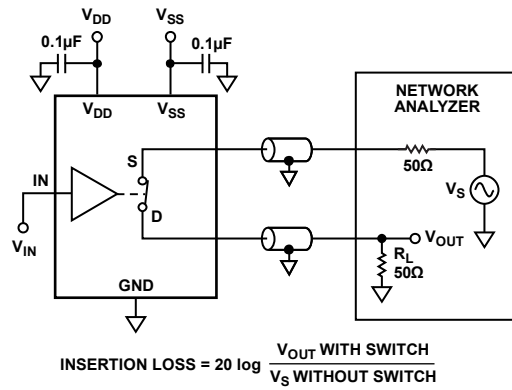

Figure 19. Charge Injection



$$\text{OFF ISOLATION} = 20 \log \frac{V_{OUT}}{V_S}$$

Figure 20. Off Isolation



$$\text{INSERTION LOSS} = 20 \log \frac{V_{OUT \text{ WITH SWITCH}}}{V_S \text{ WITHOUT SWITCH}}$$

Figure 21. Bandwidth

ORDERING GUIDE

Model¹	Temperature Range	Package Description	Package Option	Branding²
ADG601BRTZ-REEL	-40°C to +85°C	6-Lead SOT-23	RJ-6	STB#
ADG601BRTZ-REEL7	-40°C to +85°C	6-Lead SOT-23	RJ-6	STB#
ADG601BRMZ	-40°C to +85°C	8-Lead MSOP	RM-8	S1G
ADG601BRMZ-REEL7	-40°C to +85°C	8-Lead MSOP	RM-8	S1G
ADG601C-PT7		Die		
ADG602BRTZ-REEL7	-40°C to +85°C	6-Lead SOT-23	RJ-6	S18
ADG602BRMZ	-40°C to +85°C	8-Lead MSOP	RM-8	S18
ADG602BRMZ-REEL7	-40°C to +85°C	8-Lead MSOP	RM-8	S18

¹ Z = RoHS Compliant Part, # denotes RoHS compliant product, may be top or bottom marked.

² Branding on SOT-23 and MSOP is limited to three characters due to space constraints.

X-ON Electronics

Largest Supplier of Electrical and Electronic Components

Click to view similar products for [Analogue Switch ICs category](#):

Click to view products by [Analog Devices manufacturer](#):

Other Similar products are found below :

[FSA3051TMX](#) [NLAS4684FCTCG](#) [NLAS5223BLMNR2G](#) [NLVAS4599DTT1G](#) [NLX2G66DMUTCG](#) [425541DB](#) [425528R](#) [099044FB](#)
[NLAS5123MNR2G](#) [PI5A4157CEX](#) [PI5A4599BCEX](#) [NLAS4717EPFCT1G](#) [PI5A3167CCEX](#) [SLAS3158MNR2G](#) [PI5A392AQE](#)
[PI5A4157ZUEX](#) [PI5A3166TAEX](#) [FSA634UCX](#) [TC4066BP\(N,F\)](#) [DG302BDJ-E3](#) [PI5A100QEX](#) [HV2605FG-G](#) [HV2301FG-G](#)
[RS2117YUTQK10](#) [RS2118YUTQK10](#) [RS2227XUTQK10](#) [ADG452BRZ-REEL7](#) [MAX4066ESD+](#) [MAX391CPE+](#) [MAX4730EXT+T](#)
[MAX314CPE+](#) [BU4066BCFV-E2](#) [MAX313CPE+](#) [BU4S66G2-TR](#) [NLAS3158MNR2G](#) [NLASB3157MTR2G](#) [TS3A4751PWR](#)
[NLAS4157DFT2G](#) [NLAS4599DFT2G](#) [NLASB3157DFT2G](#) [NLAST4599DFT2G](#) [NLAST4599DTT1G](#) [DG300BDJ-E3](#) [DG2503DB-T2-GE1](#)
[DG2502DB-T2-GE1](#) [TC4W53FU\(TE12L,F\)](#) [74HC2G66DC.125](#) [ADG619BRMZ-REEL](#) [ADG1611BRUZ-REEL7](#) [LTC201ACN#PBF](#)