

**FEATURES**

**1.8 V to 5.5 V single supply**  
**4 Ω (max) on resistance**  
**0.75 Ω (typ) on resistance flatness**  
**–3 dB bandwidth > 200 MHz**  
**Rail-to-rail operation**  
**6-Lead SOT-23 package and 8-Lead MSOP package**  
**Fast switching times:**  
     $t_{ON} = 12 \text{ ns}$   
     $t_{OFF} = 6 \text{ ns}$   
**Typical power consumption: (< 0.01 μW)**  
**TTL/CMOS compatible**

**APPLICATIONS**

**Battery-powered systems**  
**Communication systems**  
**Sample-and-hold systems**  
**Audio signal routing**  
**Video switching**  
**Mechanical reed relay replacement**

**GENERAL DESCRIPTION**

The ADG719 is a monolithic CMOS SPDT switch. This switch is designed on a submicron process that provides low power dissipation yet gives high switching speed, low on resistance, and low leakage currents.

The ADG719 can operate from a single-supply range of 1.8 V to 5.5 V, making it ideal for use in battery-powered instruments and with the new generation of DACs and ADCs from Analog Devices, Inc.

Each switch of the ADG719 conducts equally well in both directions when on. The ADG719 exhibits break-before-make switching action.

Because of the advanced submicron process, –3 dB bandwidths of greater than 200 MHz can be achieved.

The ADG719 is available in a 6-lead SOT-23 package and an 8-lead MSOP package.

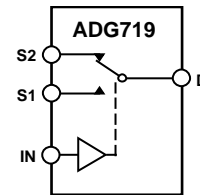
**FUNCTIONAL BLOCK DIAGRAM**

NOTES  
1. SWITCHES SHOWN FOR A LOGIC 1 INPUT.

Figure 1.

08709-001

**PRODUCT HIGHLIGHTS**

- 1.8 V to 5.5 V Single-Supply Operation. The ADG719 offers high performance, including low on resistance and fast switching times, and is fully specified and guaranteed with 3 V and 5 V supply rails.
- Very Low  $R_{ON}$  (4 Ω Max at 5 V and 10 Ω Max at 3 V). At 1.8 V operation,  $R_{ON}$  is typically 40 Ω over the temperature range.
- Automotive Temperature Range: –40°C to +125°C.
- On Resistance Flatness ( $R_{FLAT(ON)}$ ) (0.75 Ω typ).
- 3 dB Bandwidth > 200 MHz.
- Low Power Dissipation. CMOS construction ensures low power dissipation.
- Fast  $t_{ON}/t_{OFF}$ .
- Tiny, 6-lead SOT-23 and 8-lead MSOP packages.

**Rev. D**

Information furnished by Analog Devices is believed to be accurate and reliable. However, no responsibility is assumed by Analog Devices for its use, nor for any infringements of patents or other rights of third parties that may result from its use. Specifications subject to change without notice. No license is granted by implication or otherwise under any patent or patent rights of Analog Devices. Trademarks and registered trademarks are the property of their respective owners.

**TABLE OF CONTENTS**

Features .....	1	Typical Performance Characteristics .....	7
Applications.....	1	Test Circuits.....	9
Functional Block Diagram .....	1	Terminology .....	11
General Description .....	1	Applications Information .....	12
Product Highlights .....	1	ADG719 Supply Voltages .....	12
Revision History .....	2	On Response vs. Frequency .....	12
Specifications.....	3	Off Isolation .....	12
Absolute Maximum Ratings.....	5	Outline Dimensions .....	13
ESD Caution.....	5	Ordering Guide .....	14
Pin Configuration and Function Descriptions.....	6		

**REVISION HISTORY**

**3/10—Rev. C to Rev. D**

Removed B Version Text.....	Throughout
Changes to Figure 1 .....	1
Deleted Endnote 1 (Table 1).....	3
Deleted Endnote 1 (Table 2).....	4
Changes to Figure 2.....	6
Changes to Ordering Guide .....	14

**12/09—Rev. B to Rev. C**

Updated Format.....	Universal
Changes to Table 3.....	5
Added Table 4.....	6
Changes to Terminology Section.....	11
Updated Outline Dimensions .....	13
Changes to Ordering Guide .....	14

**7/02—Rev. A to Rev. B.**

Changes to Product Name.....	1
Changes to Features.....	1
Additions to Product Highlights .....	1
Changes to Specifications .....	2
Edits to Absolute Maximum Ratings .....	4
Changes to Terminology.....	4
Edits to Ordering Guide .....	4
Added New TPCs 4 and 5 .....	5
Replaced TPC 10.....	6
Test Circuits 6, 7, and 8 Replaced.....	7
Updated RM-8 and RT-6 Package Outlines .....	9

## SPECIFICATIONS

$V_{DD} = 5\text{ V} \pm 10\%$ ,  $GND = 0\text{ V}$ .

**Table 1.**

Parameter	+25°C	−40°C to +85°C	−40°C to +125°C	Unit	Test Conditions/Comments
<b>ANALOG SWITCH</b>					
Analogue Signal Range			0 V to $V_{DD}$	V	
On Resistance ( $R_{ON}$ )	2.5			$\Omega$ typ	$V_S = 0\text{ V to }V_{DD}$ , $I_S = -10\text{ mA}$ ; See Figure 14
	4	5	7	$\Omega$ max	
On Resistance Match Between Channels ( $\Delta R_{ON}$ )		0.1		$\Omega$ typ	$V_S = 0\text{ V to }V_{DD}$ , $I_S = -10\text{ mA}$
		0.4	0.4	$\Omega$ max	
On Resistance Flatness ( $R_{FLAT(ON)}$ )	0.75			$\Omega$ typ	$V_S = 0\text{ V to }V_{DD}$ , $I_S = -10\text{ mA}$
		1.2	1.5	$\Omega$ max	
<b>LEAKAGE CURRENTS <math>I_S</math> (Off)</b>					
Source Off Leakage	$\pm 0.01$			nA typ	$V_{DD} = 5.5\text{ V}$ $V_S = 4.5\text{ V}/1\text{ V}$ , $V_D = 1\text{ V}/4.5\text{ V}$ ; See Figure 15
Channel On Leakage $I_D$ , $I_S$ (On)	$\pm 0.25$	$\pm 0.35$	1	nA max	$V_S = V_D = 1\text{ V}$ or $V_S = V_D = 4.5\text{ V}$ ; See Figure 16
	$\pm 0.01$			nA typ	
	$\pm 0.25$	$\pm 0.35$	5	nA max	
<b>DIGITAL INPUTS</b>					
Input High Voltage, $V_{INH}$			2.4	V min	
Input Low Voltage, $V_{INL}$			0.8	V max	
Input Current $I_{INL}$ or $I_{INH}$	0.005			$\mu\text{A}$ typ	$V_{IN} = V_{INL}$ or $V_{INH}$
			$\pm 0.1$	$\mu\text{A}$ max	
<b>DYNAMIC CHARACTERISTICS<sup>1</sup></b>					
$t_{ON}$	7			ns typ	$R_L = 300\ \Omega$ , $C_L = 35\text{ pF}$ $V_S = 3\text{ V}$ ; See Figure 17
			12	ns max	
$t_{OFF}$	3			ns typ	$R_L = 300\ \Omega$ , $C_L = 35\text{ pF}$ $V_S = 3\text{ V}$ ; See Figure 17
			6	ns max	
Break-Before-Make Time Delay, $t_D$	8			ns typ	$R_L = 300\ \Omega$ , $C_L = 35\text{ pF}$ , $V_{S1} = V_{S2} = 3\text{ V}$ ; See Figure 18
			1	ns min	
Off Isolation	−67			dB typ	$R_L = 50\ \Omega$ , $C_L = 5\text{ pF}$ , $f = 10\text{ MHz}$
	−87			dB typ	$R_L = 50\ \Omega$ , $C_L = 5\text{ pF}$ , $f = 1\text{ MHz}$ ; See Figure 19
Channel-to-Channel Crosstalk	−62			dB typ	$R_L = 50\ \Omega$ , $C_L = 5\text{ pF}$ , $f = 10\text{ MHz}$
	−82			dB typ	$R_L = 50\ \Omega$ , $C_L = 5\text{ pF}$ , $f = 1\text{ MHz}$ ; See Figure 20
Bandwidth −3 dB	200			MHz typ	$R_L = 50\ \Omega$ , $C_L = 5\text{ pF}$ ; See Figure 21
$C_S$ (Off)	7			pF typ	
$C_D$ , $C_S$ (On)	27			pF typ	
<b>POWER REQUIREMENTS</b>					
$I_{DD}$	0.001			$\mu\text{A}$ typ	$V_{DD} = 5.5\text{ V}$ Digital inputs = 0 V or 5.5 V
			1.0	$\mu\text{A}$ max	

<sup>1</sup> Guaranteed by design, not subject to production test.

# ADG719

$V_{DD} = 3\text{ V} \pm 10\%$ ,  $GND = 0\text{ V}$ .

**Table 2.**

Parameter	+25°C	-40°C to +85°C	-40°C to +125°C	Unit	Test Conditions/Comments
<b>ANALOG SWITCH</b>					
Analog Signal Range			0 V to $V_{DD}$	V	
On Resistance ( $R_{ON}$ )	6	7		$\Omega$ typ $\Omega$ max	$V_S = 0\text{ V to }V_{DD}$ , $I_S = -10\text{ mA}$ ; See Figure 14
On Resistance Match Between Channels ( $\Delta R_{ON}$ )		0.1	12	$\Omega$ typ $\Omega$ max	$V_S = 0\text{ V to }V_{DD}$ , $I_S = -10\text{ mA}$
On Resistance Flatness ( $R_{FLAT(ON)}$ )		0.4 2.5	0.4	$\Omega$ typ $\Omega$ max	$V_S = 0\text{ V to }V_{DD}$ , $I_S = -10\text{ mA}$
<b>LEAKAGE CURRENTS</b>					
Source Off Leakage $I_S$ (Off)	$\pm 0.01$			nA typ nA max	$V_{DD} = 3.3\text{ V}$ $V_S = 3\text{ V}/1\text{ V}$ , $V_D = 1\text{ V}/3\text{ V}$ ; See Figure 15
Channel On Leakage $I_D$ , $I_S$ (On)	$\pm 0.01$ $\pm 0.25$	$\pm 0.35$	1	nA typ nA max	$V_S = V_D = 1\text{ V}$ or $V_S = V_D = 3\text{ V}$ ; See Figure 16
<b>DIGITAL INPUTS</b>					
Input High Voltage, $V_{INH}$			2.0	V min	
Input Low Voltage, $V_{INL}$			0.8	V max	
Input Current $I_{INL}$ or $I_{INH}$	0.005		$\pm 0.1$	$\mu\text{A}$ typ $\mu\text{A}$ max	$V_{IN} = V_{INL}$ or $V_{INH}$
<b>DYNAMIC CHARACTERISTICS<sup>1</sup></b>					
$t_{ON}$	10		15	ns typ ns max	$R_L = 300\ \Omega$ , $C_L = 35\text{ pF}$ $V_S = 2\text{ V}$ ; See Figure 17
$t_{OFF}$	4		8	ns typ ns max	$R_L = 300\ \Omega$ , $C_L = 35\text{ pF}$ $V_S = 2\text{ V}$ ; See Figure 17
Break-Before-Make Time Delay, $t_D$	8		1	ns typ ns min	$R_L = 300\ \Omega$ , $C_L = 35\text{ pF}$ $V_{S1} = V_{S2} = 2\text{ V}$ ; See Figure 18
Off Isolation	-67 -87			dB typ dB typ	$R_L = 50\ \Omega$ , $C_L = 5\text{ pF}$ , $f = 10\text{ MHz}$ $R_L = 50\ \Omega$ , $C_L = 5\text{ pF}$ , $f = 1\text{ MHz}$ ; See Figure 19
Channel-to-Channel Crosstalk	-62 -82			dB typ dB typ	$R_L = 50\ \Omega$ , $C_L = 5\text{ pF}$ , $f = 10\text{ MHz}$ $R_L = 50\ \Omega$ , $C_L = 5\text{ pF}$ , $f = 1\text{ MHz}$ ; See Figure 20
Bandwidth -3 dB	200			MHz typ	$R_L = 50\ \Omega$ , $C_L = 5\text{ pF}$ ; See Figure 21
$C_S$ (Off)	7			pF typ	
$C_D$ , $C_S$ (On)	27			pF typ	
<b>POWER REQUIREMENTS</b>					
$I_{DD}$	0.001 1.0			$\mu\text{A}$ typ $\mu\text{A}$ max	$V_{DD} = 3.3\text{ V}$ Digital inputs = 0 V or 3.3 V

<sup>1</sup> Guaranteed by design, not subject to production test.

## ABSOLUTE MAXIMUM RATINGS

$T_A = 25^\circ\text{C}$ , unless otherwise noted.

**Table 3.**

Parameter	Rating
$V_{DD}$ to GND	$-0.3\text{ V to }+7\text{ V}$
Analog, Digital Inputs <sup>1</sup>	$-0.3\text{ V to }V_{DD} + 0.3\text{ V}$ or 30 mA, whichever occurs first
Peak Current, S or D	100 mA (Pulsed at 1 ms, 10% duty cycle max)
Continuous Current, S or D	30 mA
Operating Temperature Range	$-40^\circ\text{C to }+125^\circ\text{C}$
Storage Temperature Range	$-65^\circ\text{C to }+150^\circ\text{C}$
Junction Temperature	$150^\circ\text{C}$
MSOP Package, Power Dissipation	315 mW
$\theta_{JA}$ Thermal Impedance	$206^\circ\text{C/W}$
$\theta_{JC}$ Thermal Impedance	$44^\circ\text{C/W}$
SOT-23 Package, Power Dissipation	282 mW
$\theta_{JA}$ Thermal Impedance	$229.6^\circ\text{C/W}$
$\theta_{JC}$ Thermal Impedance	$91.99^\circ\text{C/W}$
Lead Soldering	
Lead Temperature, Soldering (10 sec)	$300^\circ\text{C}$
IR Reflow, Peak Temperature (<20 sec)	$220^\circ\text{C}$
Soldering (Pb-Free)	
Reflow, Peak Temperature	$260(+0/-5)^\circ\text{C}$
Time at Peak Temperature	20 sec to 40 sec
ESD	1 kV

<sup>1</sup> Overvoltages at IN, S, or D will be clamped by internal diodes. Current should be limited to the maximum ratings given

Stresses above those listed under Absolute Maximum Ratings may cause permanent damage to the device. This is a stress rating only; functional operation of the device at these or any other conditions above those indicated in the operational section of this specification is not implied. Exposure to absolute maximum rating conditions for extended periods may affect device reliability.

Only one maximum rating may be applied at any one time.

### ESD CAUTION



#### ESD (electrostatic discharge) sensitive device.

Charged devices and circuit boards can discharge without detection. Although this product features patented or proprietary protection circuitry, damage may occur on devices subjected to high energy ESD. Therefore, proper ESD precautions should be taken to avoid performance degradation or loss of functionality.

# ADG719

## PIN CONFIGURATION AND FUNCTION DESCRIPTIONS

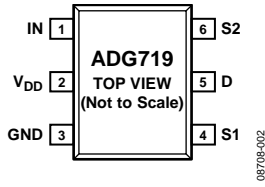

Figure 2. 6-Lead SOT-23

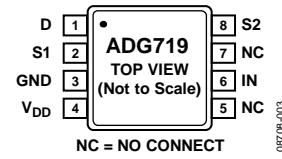

Figure 3. 8-Lead MSOP

Table 4. Pin description

Pin Number		Mnemonic	Description
MSOP	SOT-23		
1	5	D	Drain Terminal. Can be used as an input or output.
2	4	S1	Source Terminal. Can be used as an input or output.
3	3	GND	Ground (0 V) Reference Pin.
4	2	VDD	Most Positive Power Supply Pin.
5	–	NC	Not Internally Connected.
6	1	IN	Digital Switch Control Pin.
7	–	NC	Not Internally Connected.
8	6	S2	Source Terminal. Can be used as an input or output.

Table 5. Truth Table

ADG719 IN	Switch S1	Switch S2
0	ON	OFF
1	OFF	ON

# TYPICAL PERFORMANCE CHARACTERISTICS

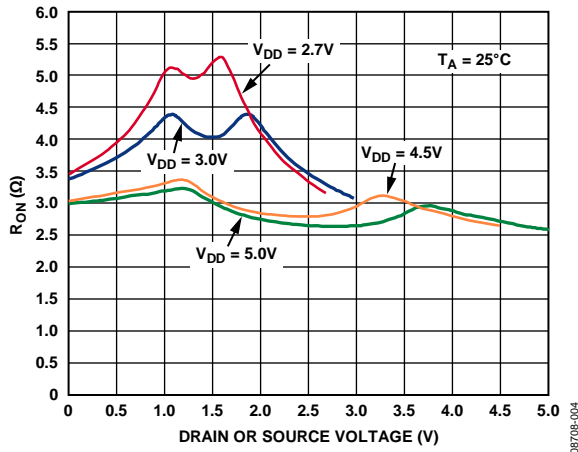

Figure 4. On Resistance vs.  $V_D$  ( $V_S$ ), Single Supplies

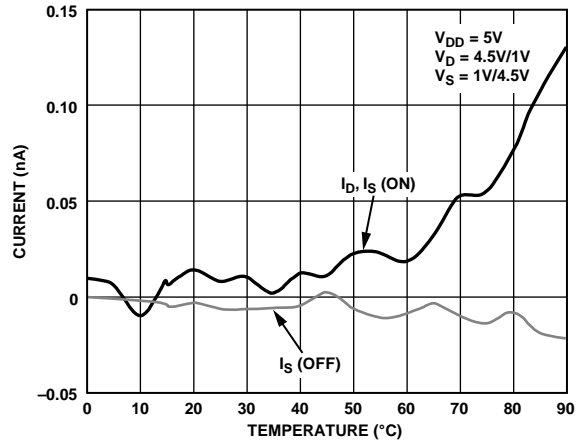

Figure 7. Leakage Currents vs. Temperature

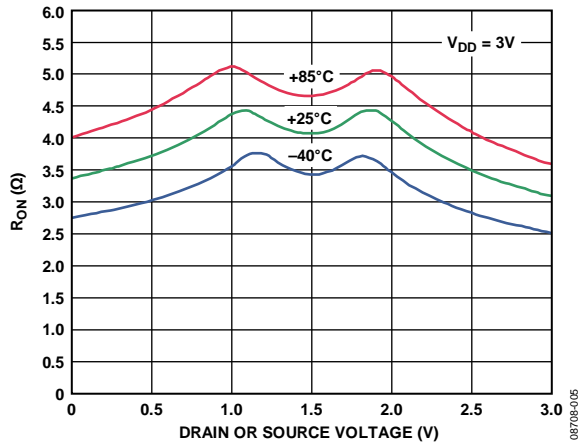

Figure 5. On Resistance vs.  $V_D$  ( $V_S$ ) for Different Temperatures,  $V_{DD} = 3V$

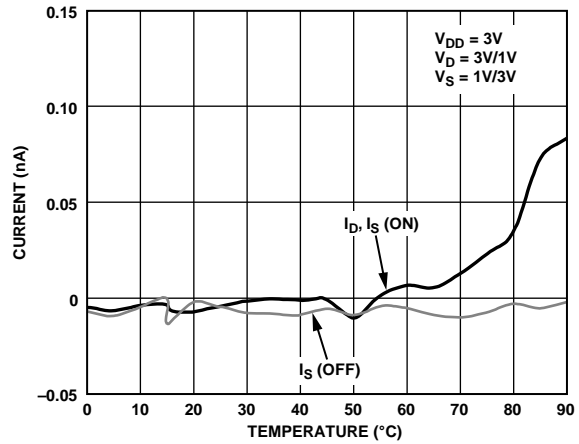

Figure 8. Leakage Currents vs. Temperature

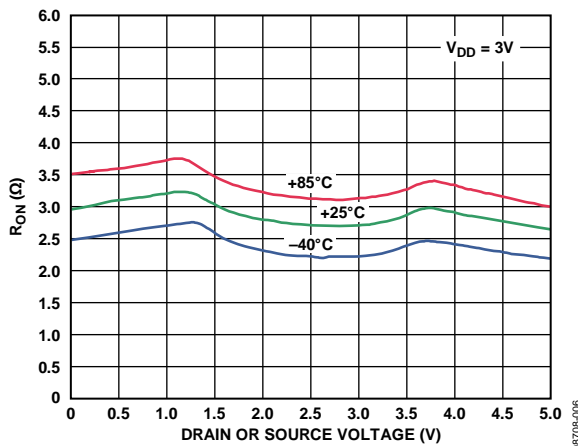

Figure 6. On Resistance vs.  $V_D$  ( $V_S$ ) for Different Temperatures,  $V_{DD} = 5V$

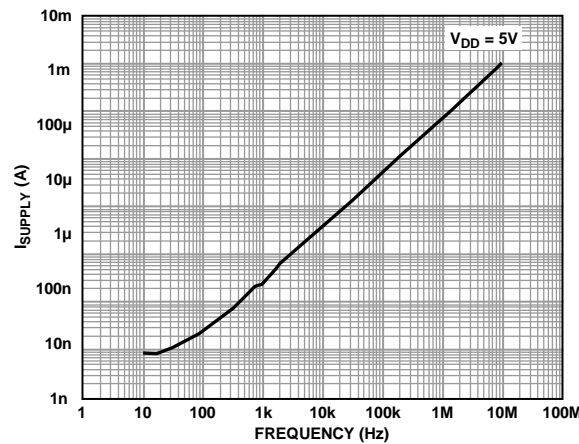

Figure 9. Supply Current vs. Input Switching Frequency

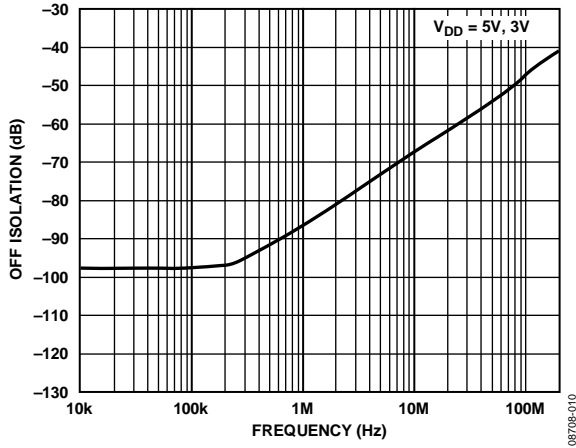

Figure 10. Off Isolation vs. Frequency

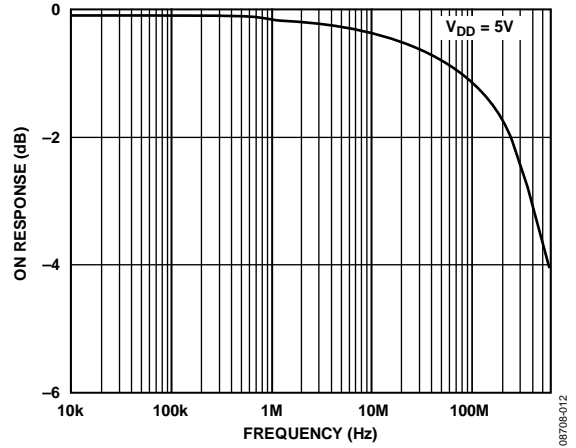

Figure 12. On Response vs. Frequency

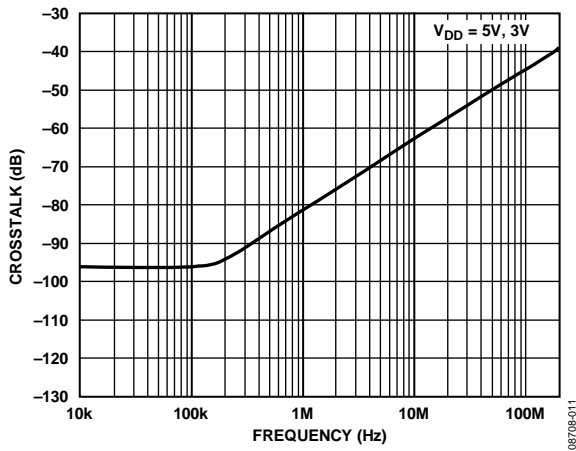

Figure 11. Crosstalk vs. Frequency

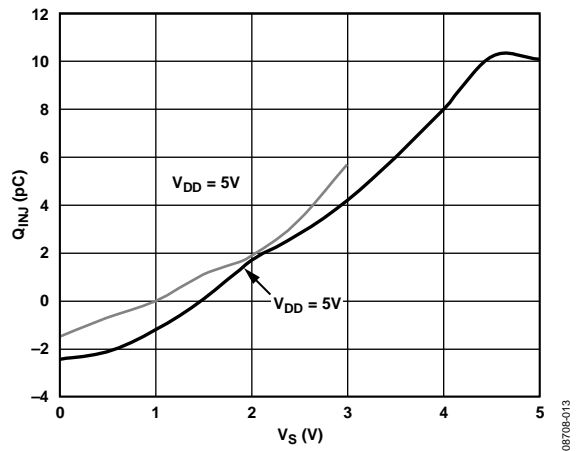

Figure 13. Charge Injection vs. Source Voltage



TEST CIRCUITS

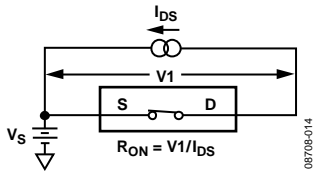

Figure 14. On Resistance

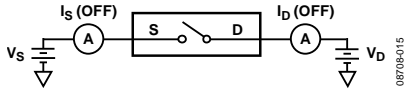

Figure 15. Off Leakage

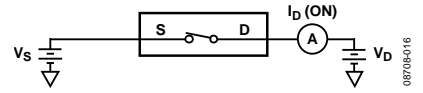

Figure 16. On Leakage

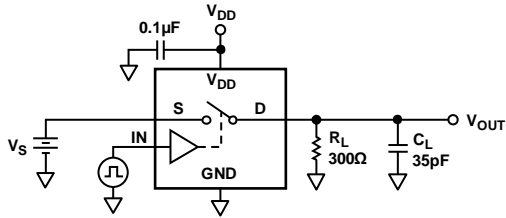

Figure 17. Switching Times

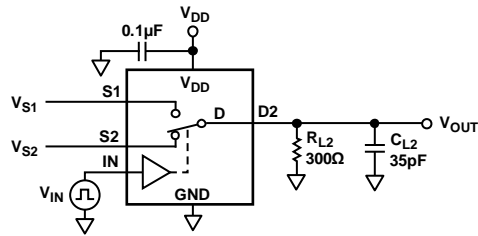
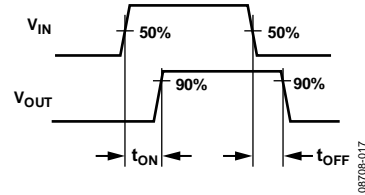
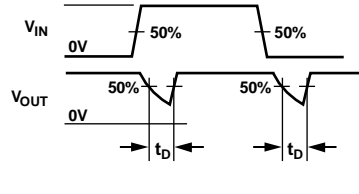

Figure 18. Break-Before-Make Time Delay,  $t_D$



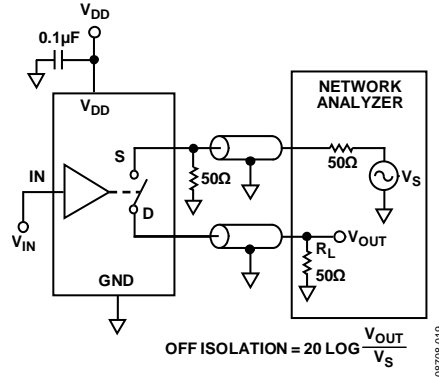

Figure 19. Off Isolation

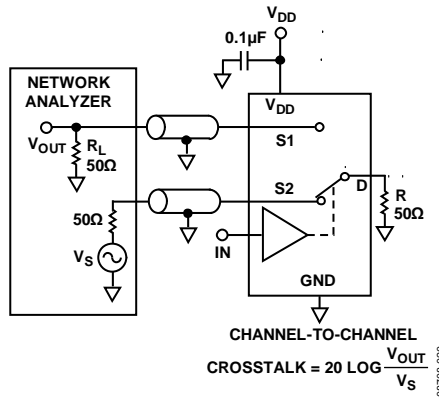

Figure 20. Channel-to-Channel Crosstalk

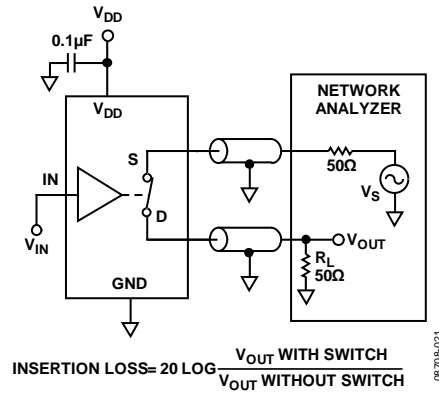

Figure 21. Bandwidth

## TERMINOLOGY

 **$R_{ON}$** 

Ohmic Resistance between D and S.

 **$\Delta R_{ON}$** 

On Resistance Match between Any Two Channels that is,  $R_{ON\ max} - R_{ON\ min}$ .

 **$R_{FLAT(ON)}$** 

Flatness is defined as the difference between the maximum and minimum value of on resistance, as measured over the specified analog signal range.

 **$I_S$  (Off)**

Source Leakage Current with the Switch Off.

 **$I_D, I_S$  (On)**

Channel Leakage Current with the Switch On.

 **$V_D$  ( $V_S$ )**

Analog Voltage on Terminals D and S.

 **$C_S$  (Off)**

Off Switch Source Capacitance.

 **$C_D, C_S$  (On)**

On Switch Capacitance.

 **$t_{ON}$** 

Delay between Applying the Digital Control Input and the Output Switching On.

 **$t_{OFF}$** 

Delay between Applying the Digital Control Input and the Output Switching Off.

 **$t_D$** 

Off Time or On Time Measured between the 90% Points of Both Switches, when Switching From One Address State to Another.

**Crosstalk**

A Measure of Unwanted Signal That Is Coupled through from One Channel to Another as a Result of Parasitic Capacitance.

**Off Isolation**

A Measure of Unwanted Signal Coupling through an Off Switch.

**Bandwidth**

The Frequency at Which the Output is Attenuated by  $-3$  dBs.

**On Response**

The Frequency Response of the On Switch.

**Insertion Loss**

Loss due to On Resistance of Switch.

## APPLICATIONS INFORMATION

The ADG719 belongs to Analog Devices' new family of CMOS switches. This series of general-purpose switches has improved switching times, lower on resistance, higher bandwidths, low power consumption, and low leakage currents.

### ADG719 SUPPLY VOLTAGES

Functionality of the ADG719 extends from 1.8 V to 5.5 V single supply, which makes it ideal for battery-powered instruments where power efficiency and performance are important design parameters.

It is important to note that the supply voltage effects the input signal range, the on resistance, and the switching times of the part. By taking a look at the Typical Performance Characteristics and the Specifications, the effects of the power supplies can be clearly seen.

For  $V_{DD} = 1.8\text{ V}$  operation,  $R_{ON}$  is typically  $40\ \Omega$  over the temperature range.

### ON RESPONSE VS. FREQUENCY

Figure 22 illustrates the parasitic components that affect the ac performance of CMOS switches (the switch is shown surrounded by a box). Additional external capacitances will further degrade some performance. These capacitances affect feedthrough, crosstalk, and system bandwidth.

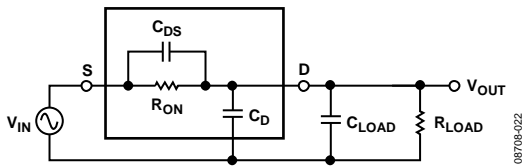

Figure 22. Switch Represented by Equivalent Parasitic Components

The transfer function that describes the equivalent diagram of the switch (Figure 22) is of the form  $A(s)$  shown below:

$$A(s) = R_T \left[ \frac{s(R_{ON} C_{DS}) + 1}{s(R_T R_{ON} C_T) + 1} \right]$$

where:

$$R_T = R_{LOAD} / (R_{LOAD} + R_{ON})$$

$$C_T = C_{LOAD} + C_D + C_{DS}$$

The signal transfer characteristic is dependent on the switch channel capacitance,  $C_{DS}$ . This capacitance creates a frequency zero in the numerator of the transfer function  $A(s)$ . Because the

switch on resistance is small, this zero usually occurs at high frequencies. The bandwidth is a function of the switch output capacitance combined with  $C_{DS}$  and the load capacitance. The frequency pole corresponding to these capacitances appears in the denominator of  $A(s)$ .

The dominant effect of the output capacitance,  $C_D$ , causes the pole breakpoint frequency to occur first. Therefore, in order to maximize bandwidth, a switch must have a low input and output capacitance and low on resistance. The On Response vs. Frequency plot for the ADG719 can be seen in Figure 12.

### OFF ISOLATION

Off isolation is a measure of the input signal coupled through an off switch to the switch output. The capacitance,  $C_{DS}$ , couples the input signal to the output load when the switch is off, as shown in Figure 23.

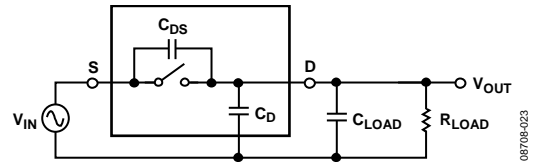
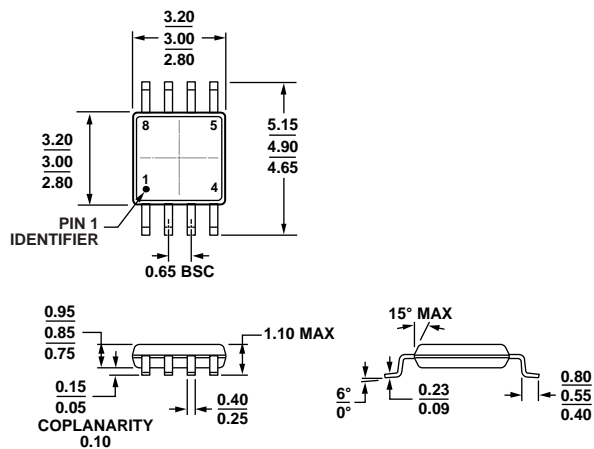

Figure 23. Off Isolation Is Affected by External Load Resistance and Capacitance

The larger the value of  $C_{DS}$ , the larger the values of feedthrough that will be produced. Figure 10 illustrates the drop in off isolation as a function of frequency. From dc to roughly 200 kHz, the switch shows better than  $-95\text{ dB}$  isolation. Up to frequencies of 10 MHz, the off isolation remains better than  $-67\text{ dB}$ . As the frequency increases, more and more of the input signal is coupled through to the output. Off isolation can be maximized by choosing a switch with the smallest  $C_{DS}$  possible. The values of load resistance and capacitance also affect off isolation, since they contribute to the coefficients of the poles and zeros in the transfer function of the switch when open.

$$A(s) = \left[ \frac{s(R_{LOAD} C_{DS})}{s(R_{LOAD})(C_{LOAD} + C_D + C_{DS}) + 1} \right]$$

# OUTLINE DIMENSIONS



COMPLIANT TO JEDEC STANDARDS MO-187-AA

Figure 24. 8-Lead Mini Small Outline Package [MSOP] (RM-8)

Dimensions shown in millimeters

100709-B

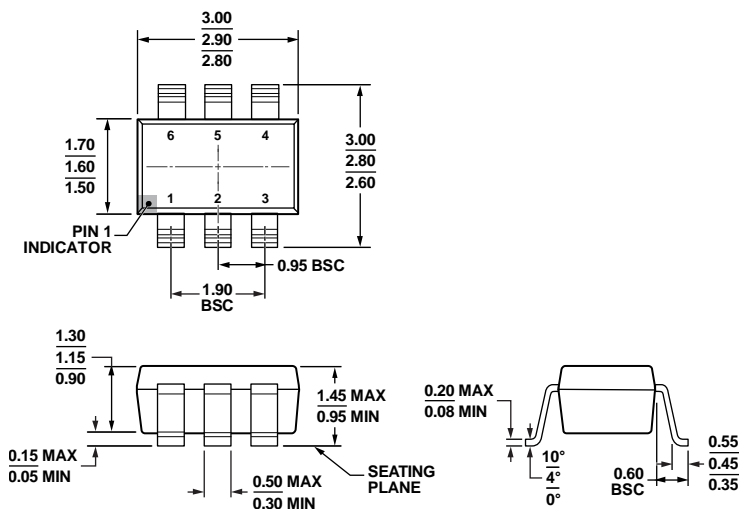

COMPLIANT TO JEDEC STANDARDS MO-178-AB

Figure 25. 6-Lead Small Outline Transistor Package [SOT-23] (RJ-6)

Dimensions shown in millimeters

121008-A

# ADG719

## ORDERING GUIDE

Model <sup>1</sup>	Temperature Range	Package Description	Package Option	Branding
ADG719BRM	-40°C to +125°C	8-Lead MSOP	RM-8	S5B
ADG719BRM-REEL	-40°C to +125°C	8-Lead MSOP	RM-8	S5B
ADG719BRM-REEL7	-40°C to +125°C	8-Lead MSOP	RM-8	S5B
ADG719BRMZ	-40°C to +125°C	8-Lead MSOP	RM-8	S5B#
ADG719BRMZ-REEL	-40°C to +125°C	8-Lead MSOP	RM-8	S5B#
ADG719BRMZ-REEL7	-40°C to +125°C	8-Lead MSOP	RM-8	S5B#
ADG719BRT-REEL	-40°C to +125°C	6-Lead SOT-23	RJ-6	S5B
ADG719BRT-REEL7	-40°C to +125°C	6-Lead SOT-23	RJ-6	S5B
ADG719BRT-500RL7	-40°C to +125°C	6-Lead SOT-23	RJ-6	S5B
ADG719BRTZ-500RL7	-40°C to +125°C	6-Lead SOT-23	RJ-6	S5B#
ADG719BRTZ-R2	-40°C to +125°C	6-Lead SOT-23	RJ-6	S5B#
ADG719BRTZ-REEL	-40°C to +125°C	6-Lead SOT-23	RJ-6	S5B#
ADG719BRTZ-REEL7	-40°C to +125°C	6-Lead SOT-23	RJ-6	S5B#

<sup>1</sup> Z = RoHS Compliant Part.

**NOTES**

**ADG719**

**NOTES**



## X-ON Electronics

Largest Supplier of Electrical and Electronic Components

*Click to view similar products for [Analogue Switch ICs category](#):*

*Click to view products by [Analog Devices manufacturer](#):*

Other Similar products are found below :

[FSA3051TMX](#) [NLAS4684FCTCG](#) [NLAS5223BLMNR2G](#) [NLVAS4599DTT1G](#) [NLX2G66DMUTCG](#) [425541DB](#) [425528R](#) [099044FB](#)  
[NLAS5123MNR2G](#) [PI5A4599BCEX](#) [NLAS4717EPFCT1G](#) [PI5A3167CCEX](#) [SLAS3158MNR2G](#) [PI5A392AQE](#) [PI5A4157ZUEX](#)  
[PI5A3166TAEX](#) [FSA634UCX](#) [TC4066BP\(N,F\)](#) [DG302BDJ-E3](#) [PI5A100QEX](#) [HV2605FG-G](#) [HV2301FG-G](#) [RS2117YUTQK10](#)  
[RS2118YUTQK10](#) [RS2227XUTQK10](#) [ADG452BRZ-REEL7](#) [MAX4066ESD+](#) [MAX391CPE+](#) [MAX4730EXT+T](#) [MAX314CPE+](#)  
[BU4066BCFV-E2](#) [MAX313CPE+](#) [BU4S66G2-TR](#) [NLAS3158MNR2G](#) [NLASB3157MTR2G](#) [TS3A4751PWR](#) [NLAS4157DFT2G](#)  
[NLAS4599DFT2G](#) [NLAST4599DFT2G](#) [NLAST4599DTT1G](#) [DG300BDJ-E3](#) [DG2503DB-T2-GE1](#) [DG2502DB-T2-GE1](#)  
[TC4W53FU\(TE12L,F\)](#) [74HC2G66DC.125](#) [ADG619BRMZ-REEL](#) [ADG1611BRUZ-REEL7](#) [LTC201ACN#PBF](#) [74LV4066DB,118](#)  
[FSA2275AUMX](#)