

## FEATURES

- 0.5  $\Omega$  typical on resistance
- 0.8  $\Omega$  maximum on resistance at 125°C
- 1.65 V to 3.6 V operation
- Automotive temperature range: -40°C to +125°C
- High current carrying capability: 300 mA continuous
- Rail-to-rail switching operation
- Fast switching times: <25 ns
- Typical power consumption <0.1  $\mu$ W

## APPLICATIONS

- Cellular phones
- MP3 players
- Power routing
- Battery-powered systems
- PCMCIA cards
- Modems
- Audio and video signal routing
- Communications systems

## GENERAL DESCRIPTION

The [ADG811/ADG812](#) are low voltage complementary metal-oxide semiconductor (CMOS) devices containing four independently selectable switches. These switches offer an ultralow on resistance of less than 0.8  $\Omega$  over the full temperature range. The digital inputs can handle 1.8 V logic with a 2.7 V to 3.6 V supply.

These devices contain four independent single-pole/single-throw (SPST) switches. The [ADG811](#) and [ADG812](#) differ only in that the digital control logic is inverted. The [ADG811](#) switches are turned on with a logic low on the appropriate control input, while a logic high is required to turn on the switches of the [ADG812](#). Each switch conducts equally well in both directions when on and has an input signal range that extends to the supplies.

Rev. D

[Document Feedback](#)

Information furnished by Analog Devices is believed to be accurate and reliable. However, no responsibility is assumed by Analog Devices for its use, nor for any infringements of patents or other rights of third parties that may result from its use. Specifications subject to change without notice. No license is granted by implication or otherwise under any patent or patent rights of Analog Devices. Trademarks and registered trademarks are the property of their respective owners.

## FUNCTIONAL BLOCK DIAGRAMS

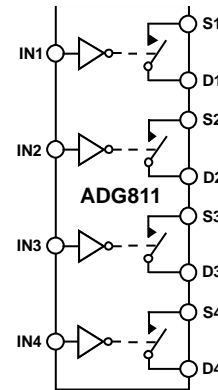

SWITCHES SHOWN FOR A LOGIC 1 INPUT

04398-A-001

Figure 1.

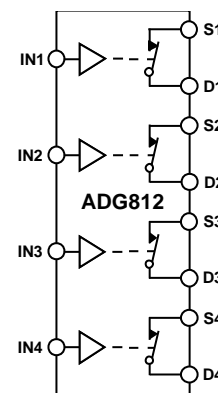

SWITCHES SHOWN FOR A LOGIC 1 INPUT

04398-A-101

Figure 2.

The [ADG811/ADG812](#) are fully specified for 3.3 V, 2.5 V, and 1.8 V supply operation. The [ADG811](#) is available in a 16-lead LFCSP, and the [ADG812](#) is available in a 16-lead TSSOP.

## PRODUCT HIGHLIGHTS

1. <0.8  $\Omega$  on resistance over the full temperature range of -40°C to +125°C.
2. Single 1.65 V to 3.6 V operation.
3. Operational with 1.8 V CMOS logic.
4. High current handling capability (300 mA continuous current at 3.3 V).
5. Low total harmonic distortion plus noise (THD + N) (0.02% typical).
6. Small, 3 mm  $\times$  3 mm, 16-lead LFCSP and 16-lead TSSOP.

## TABLE OF CONTENTS

|                                |   |   |    |
|--------------------------------|---|---|----|
| Features .....                 | 1 | Pin Configurations and Function Descriptions..... | 7  |
| Applications .....             | 1 | Typical Performance Characteristics .....         | 9  |
| Functional Block Diagrams..... | 1 | Test Circuits .....                               | 12 |
| General Description .....      | 1 | Terminology.....                                  | 14 |
| Product Highlights .....       | 1 | Outline Dimensions.....                           | 15 |
| Revision History .....         | 2 | Ordering Guide .....                              | 15 |
| Specifications .....           | 3 |   |    |
| Absolute Maximum Ratings ..... | 6 |   |    |
| ESD Caution.....               | 6 |   |    |

## REVISION HISTORY

### 8/2020—Rev. C to Rev. D

|                          |   |
|--------------------------|---|
| Changes to Table 1 ..... | 3 |
| Changes to Table 2 ..... | 4 |
| Changes to Table 3 ..... | 5 |

### 7/2016—Rev. B to Rev. C

|  |            |
|--|------------|
| Deleted ADG813 .....                             | Universal  |
| Changed CP-16-2 to CP-16-21.....                 | Throughout |
| Changes to Figure 1.....                         | 1          |
| Added Figure 2; Renumbered Sequentially .....    | 1          |
| Deleted Table 6; Renumbered Sequentially .....   | 6          |
| Changes to Figure 3 and Table 6.....             | 7          |
| Changes to Figure 4 and Table 7.....             | 8          |
| Change to Figure 16 Caption.....                 | 10         |
| Deleted Figure 23; Renumbered Sequentially ..... | 11         |
| Updated Outline Dimensions.....                  | 14         |
| Changes to Ordering Guide.....                   | 14         |

### 11/2009—Rev. A to Rev. B

|   |           |
|---|-----------|
| Added 16-Lead LFCSP .....   | Universal |
| Changes to Table 4.....   | 6         |
| Changes to Pin Configurations and Function Descriptions<br>Section..... | 7         |
| Moved Terminology Section .....   | 13        |
| Updated Outline Dimensions .....  | 14        |
| Changes to Ordering Guide.....  | 15        |

### 5/2004—Rev. 0 to Rev. A

|                               |           |
|-------------------------------|-----------|
| Updated Format .....          | Universal |
| Updated Package Choices ..... | Universal |

### 11/2003—Revision 0: Initial Version

## SPECIFICATIONS

$V_{DD} = 2.7\text{ V to }3.6\text{ V}$ ,  $GND = 0\text{ V}$ , unless otherwise noted. The temperature range for the Y version is  $-40^{\circ}\text{C to }+125^{\circ}\text{C}$ .

Table 1.

| Parameter   | +25°C                           | -40°C to +85°C | -40°C to +125°C      | Unit   | Test Conditions/Comments   |
|---|---------------------------------|----------------|----------------------|--|--|
| <b>ANALOG SWITCH</b>                                  |                                 |                |                      |  |  |
| Analog Signal Range                                   |                                 |                | 0 V to $V_{DD}$      | V  |  |
| On Resistance, $R_{ON}$                               | 0.5                             |                |                      | $\Omega$ typ                                 | $V_{DD} = 2.7\text{ V}$ , $V_S = 0\text{ V to }V_{DD}$ , $I_S = 10\text{ mA}$ ; see Figure 20                    |
| On-Resistance Match Between Channels, $\Delta R_{ON}$ | 0.75<br>0.04                    | 0.85           | 0.9                  | $\Omega$ max<br>$\Omega$ typ                 | $V_{DD} = 2.7\text{ V}$ , $V_S = 0.5\text{ V}$ , $I_S = 10\text{ mA}$  |
| On-Resistance Flatness, $R_{FLAT(ON)}$                | 0.095<br>0.1<br>0.18            | 0.095          | 0.1<br>0.19          | $\Omega$ max<br>$\Omega$ typ<br>$\Omega$ max | $V_{DD} = 2.7\text{ V}$ , $V_S = 0\text{ V to }V_{DD}$ , $I_S = 10\text{ mA}$                                    |
| <b>LEAKAGE CURRENTS</b>                               |                                 |                |                      |  |  |
| Source Off Leakage, $I_S$ (Off)                       | $\pm 0.2$                       |                |                      | nA typ                                       | $V_{DD} = 3.6\text{ V}$<br>$V_S = 0.6\text{ V}/3.3\text{ V}$ , $V_D = 3.3\text{ V}/0.6\text{ V}$ ; see Figure 21 |
| Drain Off Leakage, $I_D$ (Off)                        | $\pm 1$<br>$\pm 0.2$            | $\pm 8$        | $\pm 80$             | nA max<br>nA typ                             | $V_S = 0.6\text{ V}/3.3\text{ V}$ , $V_D = 3.3\text{ V}/0.6\text{ V}$ ; see Figure 21                            |
| Channel On Leakage, $I_D$ , $I_S$ (On)                | $\pm 1$<br>$\pm 0.2$<br>$\pm 1$ | $\pm 8$        | $\pm 80$<br>$\pm 90$ | nA max<br>nA typ<br>nA max                   | $V_S = V_D = 0.6\text{ V or }3.3\text{ V}$ ; see Figure 22   |
| <b>DIGITAL INPUTS</b>                                 |                                 |                |                      |  |  |
| Input High Voltage, $V_{INH}$                         |                                 |                | 2                    | V min  |  |
| Input Low Voltage, $V_{INL}$                          |                                 |                | 0.8                  | V max  |  |
| Input Current, $I_{INL}$ or $I_{INH}$                 | 0.005                           |                | $\pm 0.1$            | $\mu\text{A}$ typ<br>$\mu\text{A}$ max       | $V_{IN} = V_{INL}$ or $V_{INH}$  |
| Digital Input Capacitance, $C_{IN}$                   | 6                               |                |                      | pF typ                                       |  |
| <b>DYNAMIC CHARACTERISTICS<sup>1</sup></b>            |                                 |                |                      |  |  |
| $t_{ON}$  | 21<br>25                        | 26             | 28                   | ns typ<br>ns max                             | $R_L = 50\ \Omega$ , $C_L = 35\text{ pF}$<br>$V_S = 1.5\text{ V}/0\text{ V}$ ; see Figure 23                     |
| $t_{OFF}$   | 4<br>5                          | 6              | 7                    | ns typ<br>ns max                             | $R_L = 50\ \Omega$ , $C_L = 35\text{ pF}$<br>$V_S = 1.5\text{ V}$ ; see Figure 23                                |
| Charge Injection                                      | 30                              |                |                      | pC typ                                       | $V_S = 1.5\text{ V}$ , $R_S = 0\ \Omega$ , $C_L = 1\text{ nF}$ ; see Figure 24                                   |
| Off Isolation   | -67                             |                |                      | dB typ                                       | $R_L = 50\ \Omega$ , $C_L = 5\text{ pF}$ , $f = 100\text{ kHz}$ ; see Figure 25                                  |
| Channel-to-Channel Crosstalk                          | -90                             |                |                      | dB typ                                       | $R_L = 50\ \Omega$ , $C_L = 5\text{ pF}$ , $f = 100\text{ kHz}$ ; see Figure 27                                  |
| Total Harmonic Distortion Plus Noise (THD + N)        | 0.02                            |                |                      | %  | $R_L = 32\ \Omega$ , $f = 20\text{ Hz to }20\text{ kHz}$ ,<br>$V_S = 2\text{ V p-p}$                             |
| Insertion Loss  | -0.05                           |                |                      | dB typ                                       | $R_L = 50\ \Omega$ , $C_L = 5\text{ pF}$ , $f = 100\text{ kHz}$  |
| -3 dB Bandwidth                                       | 90                              |                |                      | MHz typ                                      | $R_L = 50\ \Omega$ , $C_L = 5\text{ pF}$ ; see Figure 26   |
| $C_S$ (Off)   | 30                              |                |                      | pF typ                                       |  |
| $C_D$ (Off)   | 35                              |                |                      | pF typ                                       |  |
| $C_D$ , $C_S$ (On)                                    | 60                              |                |                      | pF typ                                       |  |
| <b>POWER REQUIREMENTS</b>                             |                                 |                |                      |  |  |
| $I_{DD}$  | 0.003                           | 1.0            | 4                    | $\mu\text{A}$ typ<br>$\mu\text{A}$ max       | $V_{DD} = 3.6\text{ V}$<br>Digital inputs = 0 V or 3.6 V   |

<sup>1</sup> Guaranteed by design, but not subject to production test.

$V_{DD} = 2.5 \text{ V} \pm 0.2 \text{ V}$ ,  $GND = 0 \text{ V}$ , unless otherwise noted. The temperature range for the Y version is  $-40^\circ\text{C}$  to  $+125^\circ\text{C}$ .

Table 2.

| Parameter   | +25°C                           | -40°C to +85°C      | -40°C to +125°C      | Unit   | Test Conditions/Comments  |
|---|---------------------------------|---------------------|----------------------|--|---|
| <b>ANALOG SWITCH</b>                                  |                                 |                     |                      |  |   |
| Analog Signal Range                                   |                                 |                     | 0 V to $V_{DD}$      | V  |   |
| On Resistance, $R_{ON}$                               | 0.65                            |                     |                      | $\Omega$ typ                                 | $V_{DD} = 2.3 \text{ V}$ , $V_S = 0 \text{ V}$ to $V_{DD}$ , $I_S = 10 \text{ mA}$ ; see Figure 20                    |
| On-Resistance Match Between Channels, $\Delta R_{ON}$ | 0.84<br>0.04                    | 0.92                | 1.0                  | $\Omega$ max<br>$\Omega$ typ                 | $V_{DD} = 2.3 \text{ V}$ , $V_S = 0.55 \text{ V}$ , $I_S = 10 \text{ mA}$   |
| On-Resistance Flatness, $R_{FLAT(ON)}$                | 0.1<br>0.16<br>0.25             | 0.1<br>0.25         | 0.105<br>0.26        | $\Omega$ max<br>$\Omega$ typ<br>$\Omega$ max | $V_{DD} = 2.3 \text{ V}$ , $V_S = 0 \text{ V}$ to $V_{DD}$ , $I_S = 10 \text{ mA}$                                    |
| <b>LEAKAGE CURRENTS</b>                               |                                 |                     |                      |  |   |
| Source Off Leakage, $I_S$ (Off)                       | $\pm 0.2$                       |                     |                      | nA typ                                       | $V_{DD} = 2.7 \text{ V}$<br>$V_S = 0.6 \text{ V}/2.4 \text{ V}$ , $V_D = 2.4 \text{ V}/0.6 \text{ V}$ ; see Figure 21 |
| Drain Off Leakage, $I_D$ (Off)                        | $\pm 1$<br>$\pm 0.2$            | $\pm 6$             | $\pm 35$             | nA max<br>nA typ                             | $V_S = 0.6 \text{ V}/2.4 \text{ V}$ , $V_D = 2.4 \text{ V}/0.6 \text{ V}$ ; see Figure 21                             |
| Channel On Leakage, $I_D$ , $I_S$ (On)                | $\pm 1$<br>$\pm 0.2$<br>$\pm 1$ | $\pm 6$<br>$\pm 11$ | $\pm 35$<br>$\pm 70$ | nA max<br>nA typ<br>nA max                   | $V_S = V_D = 0.6 \text{ V}$ or $2.4 \text{ V}$ ; see Figure 22  |
| <b>DIGITAL INPUTS</b>                                 |                                 |                     |                      |  |   |
| Input High Voltage, $V_{INH}$                         |                                 |                     | 1.7                  | V min  |   |
| Input Low Voltage, $V_{INL}$                          |                                 |                     | 0.7                  | V max  |   |
| Input Current, $I_{INL}$ or $I_{INH}$                 | 0.005                           |                     | $\pm 0.1$            | $\mu\text{A}$ typ<br>$\mu\text{A}$ max       | $V_{IN} = V_{INL}$ or $V_{INH}$   |
| Digital Input Capacitance, $C_{IN}$                   | 6                               |                     |                      | pF typ                                       |   |
| <b>DYNAMIC CHARACTERISTICS<sup>1</sup></b>            |                                 |                     |                      |  |   |
| $t_{ON}$  | 22<br>27                        | 29                  | 30                   | ns typ<br>ns max                             | $R_L = 50 \Omega$ , $C_L = 35 \text{ pF}$<br>$V_S = 1.5 \text{ V}/0 \text{ V}$ ; see Figure 23                        |
| $t_{OFF}$   | 4<br>6                          | 7                   | 8                    | ns typ<br>ns max                             | $R_L = 50 \Omega$ , $C_L = 35 \text{ pF}$<br>$V_S = 1.5 \text{ V}$ ; see Figure 23                                    |
| Charge Injection                                      | 25                              |                     |                      | pC typ                                       | $V_S = 1.25 \text{ V}$ , $R_S = 0 \Omega$ , $C_L = 1 \text{ nF}$ ; see Figure 24                                      |
| Off Isolation   | -67                             |                     |                      | dB typ                                       | $R_L = 50 \Omega$ , $C_L = 5 \text{ pF}$ , $f = 100 \text{ kHz}$ ; see Figure 25                                      |
| Channel-to-Channel Crosstalk                          | -90                             |                     |                      | dB typ                                       | $R_L = 50 \Omega$ , $C_L = 5 \text{ pF}$ , $f = 100 \text{ kHz}$ ; see Figure 27                                      |
| Total Harmonic Distortion Plus Noise (THD + N)        | 0.022                           |                     |                      | %  | $R_L = 32 \Omega$ , $f = 20 \text{ Hz}$ to $20 \text{ kHz}$ , $V_S = 1.5 \text{ V}$ p-p                               |
| Insertion Loss  | -0.06                           |                     |                      | dB typ                                       | $R_L = 50 \Omega$ , $C_L = 5 \text{ pF}$ , $f = 100 \text{ kHz}$  |
| -3 dB Bandwidth                                       | 90                              |                     |                      | MHz typ                                      | $R_L = 50 \Omega$ , $C_L = 5 \text{ pF}$ ; see Figure 26  |
| $C_S$ (Off)   | 32                              |                     |                      | pF typ                                       |   |
| $C_D$ (Off)   | 37                              |                     |                      | pF typ                                       |   |
| $C_D$ , $C_S$ (On)                                    | 60                              |                     |                      | pF typ                                       |   |
| <b>POWER REQUIREMENTS</b>                             |                                 |                     |                      |  |   |
| $I_{DD}$  | 0.003                           | 1.0                 | 4                    | $\mu\text{A}$ typ<br>$\mu\text{A}$ max       | $V_{DD} = 2.7 \text{ V}$<br>Digital inputs = 0 V or 2.7 V   |

<sup>1</sup> Guaranteed by design, but not subject to production test.

$V_{DD} = 1.65\text{ V to }1.95\text{ V}$ ,  $GND = 0\text{ V}$ , unless otherwise noted. The temperature range for the Y version is  $-40^{\circ}\text{C to }+125^{\circ}\text{C}$ .

Table 3.

| Parameter   | +25°C                           | -40°C to +85°C         | -40°C to +125°C          | Unit                                   | Test Conditions/Comments  |
|---|---------------------------------|------------------------|--------------------------|--|---|
| <b>ANALOG SWITCH</b>                                  |                                 |                        |                          |  |   |
| Analog Signal Range                                   |                                 |                        | 0 V to $V_{DD}$          | V                                      |   |
| On Resistance, $R_{ON}$                               | 1                               |                        |                          | $\Omega$ typ                           | $V_{DD} = 1.8\text{ V}$ , $V_S = 0\text{ V to }V_{DD}$ , $I_S = 10\text{ mA}$ ; see Figure 20                       |
|   | 1.6                             | 2.4                    | 2.4                      | $\Omega$ max                           |   |
|   | 2.7                             | 4.2                    | 4.2                      | $\Omega$ max                           | $V_{DD} = 1.65\text{ V}$ , $V_S = 0\text{ V to }V_{DD}$ , $I_S = 10\text{ mA}$                                      |
| On-Resistance Match Between Channels, $\Delta R_{ON}$ | 0.1                             |                        |                          | $\Omega$ typ                           | $V_{DD} = 1.65\text{ V}$ , $V_S = 0.7\text{ V}$ , $I_S = 10\text{ mA}$  |
| <b>LEAKAGE CURRENTS</b>                               |                                 |                        |                          |  |   |
| Source Off Leakage $I_S$ (Off)                        | $\pm 0.2$                       |                        |                          | nA typ                                 | $V_{DD} = 1.95\text{ V}$<br>$V_S = 0.6\text{ V}/1.65\text{ V}$ , $V_D = 1.65\text{ V}/0.6\text{ V}$ ; see Figure 21 |
| Drain Off Leakage $I_D$ (Off)                         | $\pm 1$<br>$\pm 0.2$            | $\pm 5$                | $\pm 30$                 | nA max<br>nA typ                       | $V_S = 0.6\text{ V}/1.65\text{ V}$ , $V_D = 1.65\text{ V}/0.6\text{ V}$ ; see Figure 21                             |
| Channel On Leakage $I_D, I_S$ (On)                    | $\pm 1$<br>$\pm 0.2$<br>$\pm 1$ | $\pm 5$<br><br>$\pm 9$ | $\pm 30$<br><br>$\pm 60$ | nA max<br>nA typ<br>nA max             | $V_S = V_D = 0.6\text{ V or }1.65\text{ V}$ ; see Figure 22   |
| <b>DIGITAL INPUTS</b>                                 |                                 |                        |                          |  |   |
| Input High Voltage, $V_{INH}$                         |                                 |                        | $0.65V_{DD}$             | V min                                  |   |
| Input Low Voltage, $V_{INL}$                          |                                 |                        | $0.35V_{DD}$             | V max                                  |   |
| Input Current, $I_{INL}$ or $I_{INH}$                 | 0.005                           |                        |                          | $\mu\text{A}$ typ<br>$\mu\text{A}$ max | $V_{IN} = V_{INL}$ or $V_{INH}$   |
| Digital Input Capacitance, $C_{IN}$                   | 6                               |                        |                          | pF typ                                 |   |
| <b>DYNAMIC CHARACTERISTICS<sup>1</sup></b>            |                                 |                        |                          |  |   |
| $t_{ON}$  | 27<br>35                        | 36                     | 37                       | ns typ<br>ns max                       | $R_L = 50\ \Omega$ , $C_L = 35\text{ pF}$<br>$V_S = 1.5\text{ V}/0\text{ V}$ ; see Figure 23                        |
| $t_{OFF}$   | 6<br>8                          | 9                      | 10                       | ns typ<br>ns max                       | $R_L = 50\ \Omega$ , $C_L = 35\text{ pF}$<br>$V_S = 1.5\text{ V}$ ; see Figure 23                                   |
| Charge Injection                                      | 15                              |                        |                          | pC typ                                 | $V_S = 1\text{ V}$ , $R_S = 0\ \Omega$ , $C_L = 1\text{ nF}$ ; see Figure 24  |
| Off Isolation   | -67                             |                        |                          | dB typ                                 | $R_L = 50\ \Omega$ , $C_L = 5\text{ pF}$ , $f = 100\text{ kHz}$ ; Figure 25   |
| Channel-to-Channel Crosstalk                          | -90                             |                        |                          | dB typ                                 | $R_L = 50\ \Omega$ , $C_L = 5\text{ pF}$ , $f = 100\text{ kHz}$ ; see Figure 27                                     |
| Total Harmonic Distortion Plus Noise (THD + N)        | 0.14                            |                        |                          | %                                      | $R_L = 32\ \Omega$ , $f = 20\text{ Hz to }20\text{ kHz}$ , $V_S = 1.2\text{ V p-p}$                                 |
| Insertion Loss  | -0.08                           |                        |                          | dB typ                                 | $R_L = 50\ \Omega$ , $C_L = 5\text{ pF}$ , $f = 100\text{ kHz}$   |
| -3 dB Bandwidth                                       | 90                              |                        |                          | MHz typ                                | $R_L = 50\ \Omega$ , $C_L = 5\text{ pF}$ ; see Figure 26  |
| $C_S$ (Off)   | 32                              |                        |                          | pF typ                                 |   |
| $C_D$ (Off)   | 38                              |                        |                          | pF typ                                 |   |
| $C_D, C_S$ (On)                                       | 60                              |                        |                          | pF typ                                 |   |
| <b>POWER REQUIREMENTS</b>                             |                                 |                        |                          |  |   |
| $I_{DD}$  | 0.003                           | 1.0                    | 4                        | $\mu\text{A}$ typ<br>$\mu\text{A}$ max | $V_{DD} = 1.95\text{ V}$<br>Digital inputs = 0 V or 1.95 V  |

<sup>1</sup> Guaranteed by design, but not subject to production test.

## ABSOLUTE MAXIMUM RATINGS

T<sub>A</sub> = 25°C, unless otherwise noted.

Table 4.

| Parameter   | Rating  |
|---|---|
| V <sub>DD</sub> to GND                              | −0.3 V to +4.6 V                                      |
| Analog Inputs <sup>1</sup>                          | −0.3 V to V <sub>DD</sub> + 0.3 V                     |
| Digital Inputs <sup>1</sup>                         | GND − 0.3 V to 4.6 V or 10 mA, whichever occurs first |
| Peak Current, S or D                                | (Pulsed at 1 ms, 10% duty-cycle maximum)              |
| 3.3 V Operation                                     | 500 mA  |
| 2.5 V Operation                                     | 460 mA  |
| 1.8 V Operation                                     | 420 mA  |
| Continuous Current, S or D                          |   |
| 3.3 V Operation                                     | 300 mA  |
| 2.5 V Operation                                     | 275 mA  |
| 1.8 V Operation                                     | 250 mA  |
| Operating Temperature Range, Automotive (Y Version) | −40°C to +125°C                                       |
| Storage Temperature Range                           | −65°C to +150°C                                       |
| Junction Temperature                                | 150°C   |
| Thermal Impedance                                   |   |
| TSSOP   |   |
| θ <sub>JA</sub>                                     | 150°C/W   |
| θ <sub>JC</sub>                                     | 27°C/W  |
| LFCSP   |   |
| θ <sub>JA</sub>                                     | 70°C/W  |
| IR Reflow, Peak Temperature <20 sec                 | 235°C   |

<sup>1</sup> Overvoltages at IN, S, or D are clamped by internal diodes. Current should be limited to the maximum ratings given.

Stresses at or above those listed under Absolute Maximum Ratings may cause permanent damage to the product. This is a stress rating only; functional operation of the product at these or any other conditions above those indicated in the operational section of this specification is not implied. Operation beyond the maximum operating conditions for extended periods may affect product reliability.

Only one absolute maximum rating may be applied at any one time.

Table 5. ADG811/ADG812 Truth Table

| ADG811 IN | ADG812 IN | Switch Condition |
|-----------|-----------|------------------|
| 0         | 1         | On               |
| 1         | 0         | Off              |

### ESD CAUTION



**ESD (electrostatic discharge) sensitive device.** Charged devices and circuit boards can discharge without detection. Although this product features patented or proprietary protection circuitry, damage may occur on devices subjected to high energy ESD. Therefore, proper ESD precautions should be taken to avoid performance degradation or loss of functionality.

## PIN CONFIGURATIONS AND FUNCTION DESCRIPTIONS

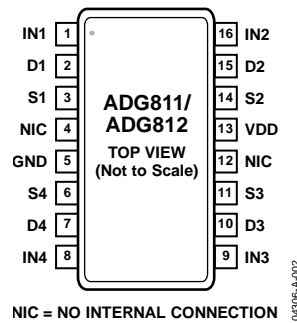
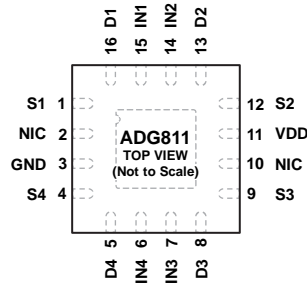

Figure 3. ADG811/ADG812 Pin Configuration (16-Lead TSSOP)

Table 6. ADG811/ADG812 Pin Function Descriptions (16-Lead TSSOP)

| Pin No.        |       | Mnemonic | Description  |
|----------------|-------|----------|--|
| TSSOP          | LCSP  |          |  |
| 1              | 15    | IN1      | Logic control input.                                 |
| 2              | 16    | D1       | Drain Terminal. This pin may be an input or output.  |
| 3              | 1     | S1       | Source Terminal. This pin may be an input or output. |
| 4, 12          | 2, 10 | NIC      | No Internal Connection.                              |
| 5              | 3     | GND      | Ground (0 V) reference.                              |
| 6              | 4     | S4       | Source Terminal. This pin may be an input or output. |
| 7              | 5     | D4       | Drain Terminal. This pin may be an input or output.  |
| 8              | 6     | IN4      | Logic Control Input.                                 |
| 9              | 7     | IN3      | Logic Control Input.                                 |
| 10             | 8     | D3       | Drain Terminal. This pin may be an input or output.  |
| 11             | 9     | S3       | Source Terminal. This pin may be an input or output. |
| 13             | 11    | VDD      | Most Positive Power Supply Potential.                |
| 14             | 12    | S2       | Source Terminal. This pin may be an input or output. |
| 15             | 13    | D2       | Drain Terminal. This pin may be an input or output.  |
| 16             | 14    | IN2      | Logic Control Input.                                 |
| Not applicable | 17    | EPAD     | Exposed Pad. Connect exposed pad to GND.             |



- NOTES**  
 1. NIC = NO INTERNAL CONNECTION.  
 2. CONNECT EXPOSED PAD TO GND.

04396-027

Figure 4. ADG811 Pin Configuration (16-Lead LFCSP)

Table 7. ADG811 Pin Function Descriptions (16-Lead LFCSP)

| Pin No. | Mnemonic | Description  |
|---------|----------|--|
| 1       | S1       | Source Terminal. This pin may be an input or output. |
| 2, 10   | NIC      | No Internal Connection.                              |
| 3       | GND      | Ground (0 V) reference.                              |
| 4       | S4       | Source Terminal. This pin may be an input or output. |
| 5       | D4       | Drain Terminal. This pin may be an input or output.  |
| 6       | IN4      | Logic Control Input.                                 |
| 7       | IN3      | Logic Control Input.                                 |
| 8       | D3       | Drain Terminal. This pin may be an input or output.  |
| 9       | S3       | Source Terminal. This pin may be an input or output. |
| 11      | VDD      | Most Positive Power Supply Potential.                |
| 12      | S2       | Source Terminal. This pin may be an input or output. |
| 13      | D2       | Drain Terminal. This pin may be an input or output.  |
| 14      | IN2      | Logic Control Input.                                 |
| 15      | IN1      | Logic control input.                                 |
| 16      | D1       | Drain Terminal. This pin may be an input or output.  |
| 17      | EPAD     | Exposed Pad. Connect exposed pad to GND.             |



TYPICAL PERFORMANCE CHARACTERISTICS

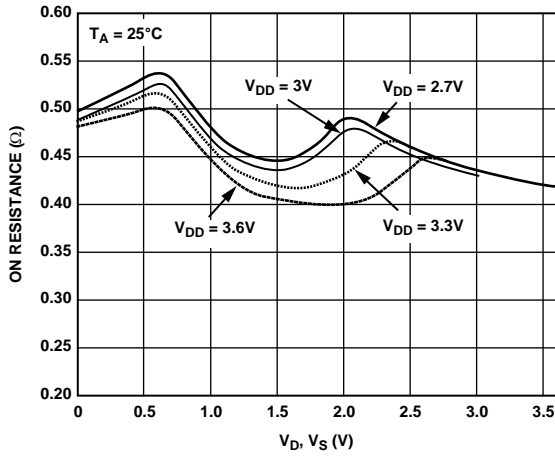

Figure 5. On Resistance vs.  $V_D (V_S)$ ,  $V_{DD} = 2.7V$  to  $3.6V$

04306-A-003

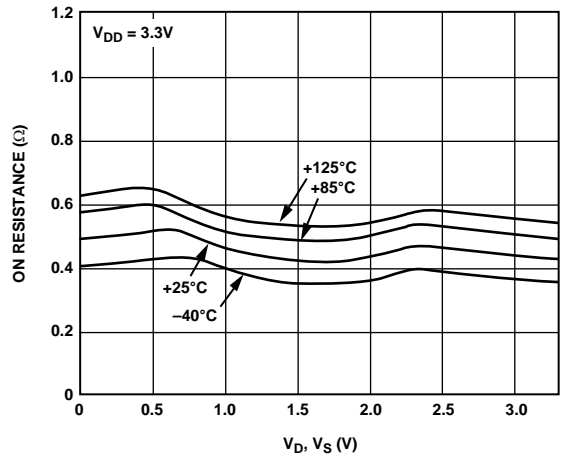

Figure 8. On Resistance vs.  $V_D (V_S)$  for Different Temperatures,  $V_{DD} = 3.3V$

04306-A-006

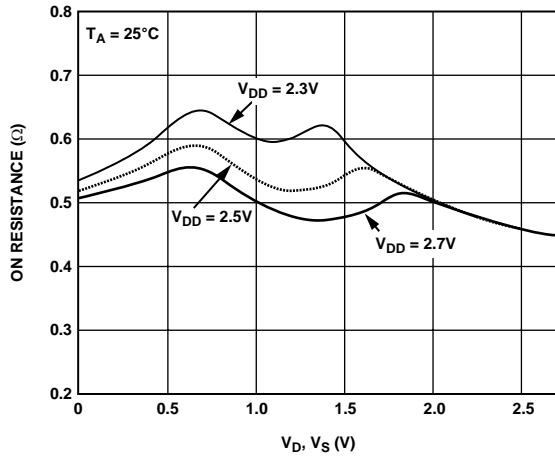

Figure 6. On Resistance vs.  $V_D (V_S)$ ,  $V_{DD} = 2.5V \pm 0.2V$

04306-A-004

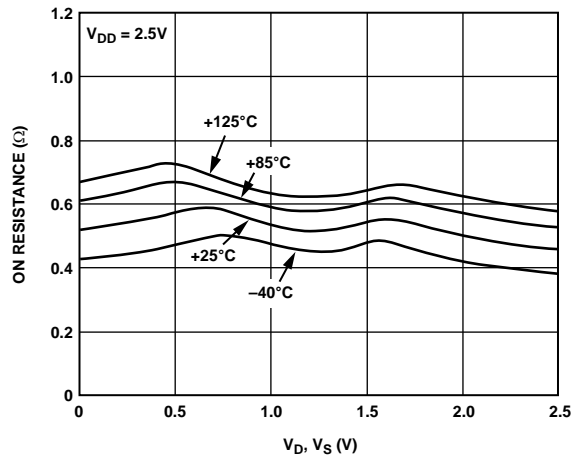

Figure 9. On Resistance vs.  $V_D (V_S)$  for Different Temperatures,  $V_{DD} = 2.5V$

04306-A-007

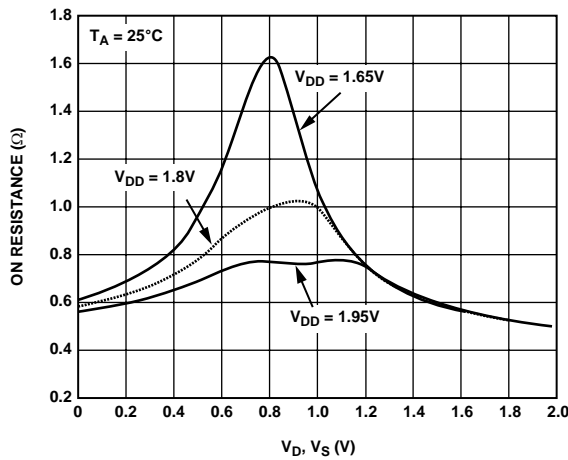

Figure 7. On Resistance vs.  $V_D (V_S)$ ,  $V_{DD} = 1.8V \pm 0.15V$

04306-A-005

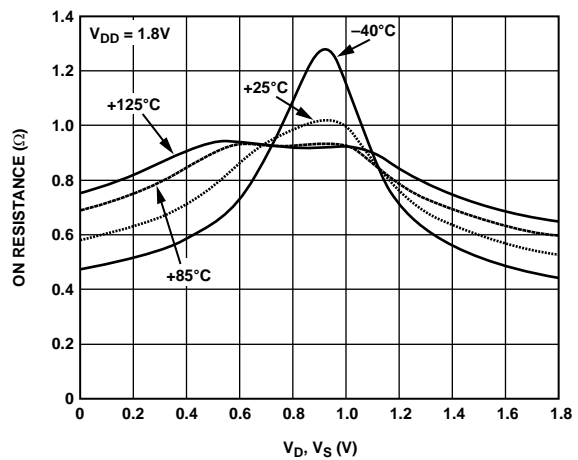

Figure 10. On Resistance vs.  $V_D (V_S)$  for Different Temperatures,  $V_{DD} = 1.8V$

04306-A-008

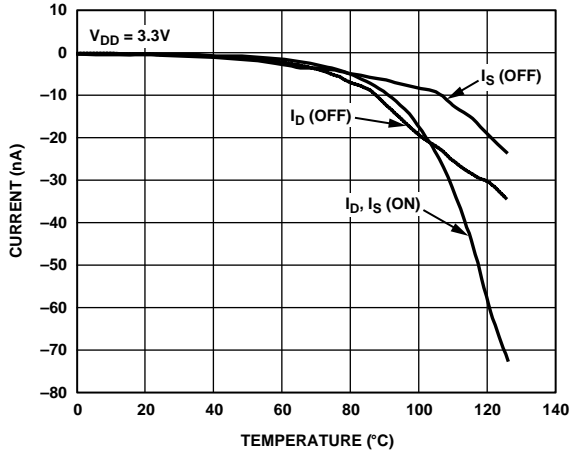

Figure 11. Leakage Current vs. Temperature,  $V_{DD} = 3.3V$

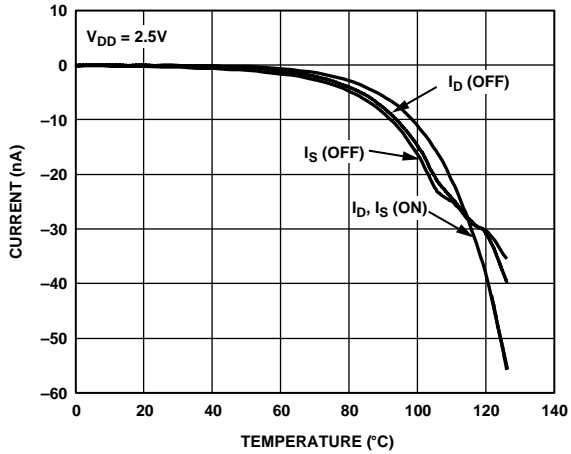

Figure 12. Leakage Current vs. Temperature,  $V_{DD} = 2.5V$

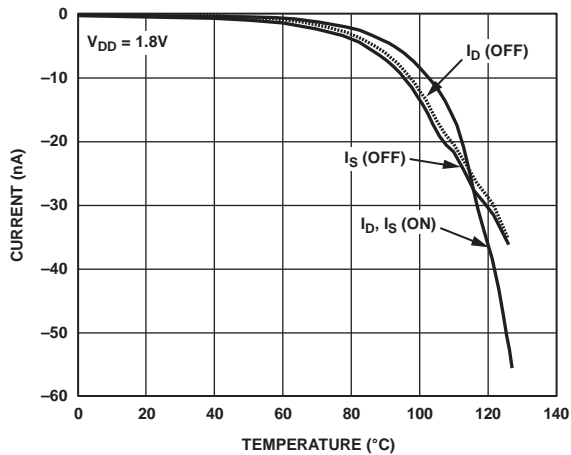

Figure 13. Leakage Current vs. Temperature,  $V_{DD} = 1.8V$

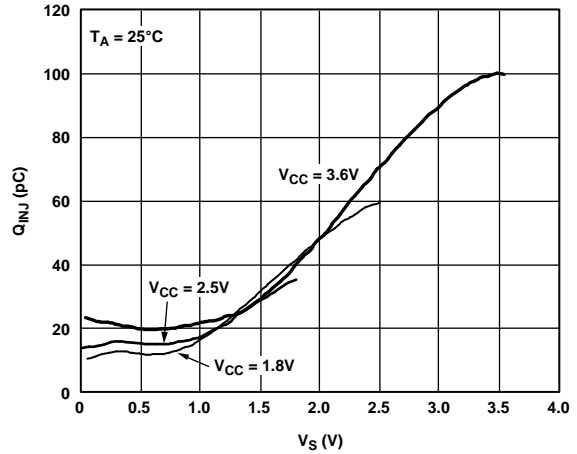

Figure 14. Charge Injection ( $Q_{INJ}$ ) vs. Source Voltage ( $V_S$ )

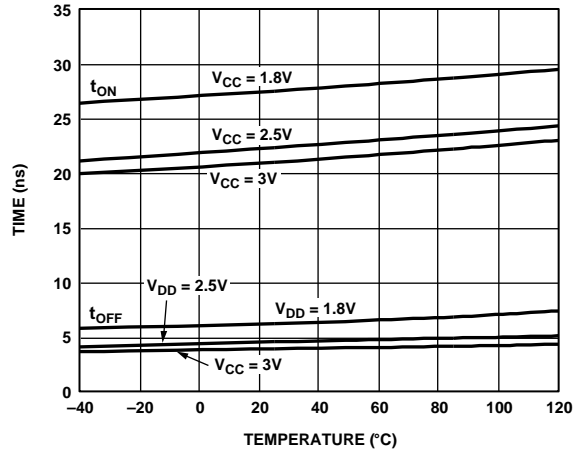

Figure 15.  $t_{ON}/t_{OFF}$  Times vs. Temperature

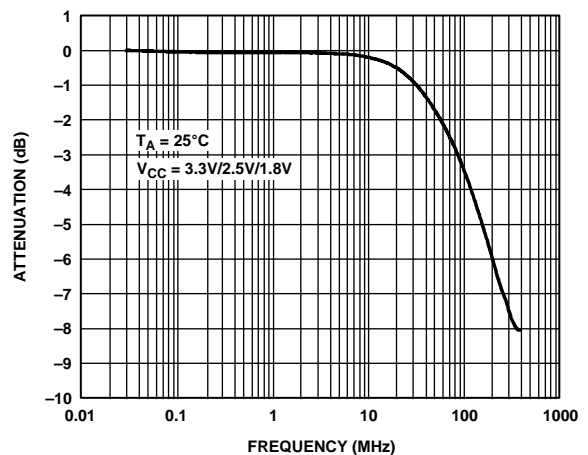

Figure 16. Bandwidth vs. Frequency

04306-A-009

04306-A-012

04306-A-010

04306-A-013

04306-A-011

04306-A-014

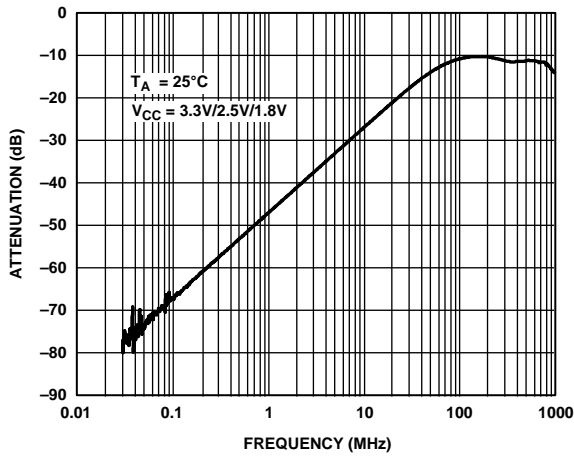

Figure 17. Crosstalk vs. Frequency

04306-A-015

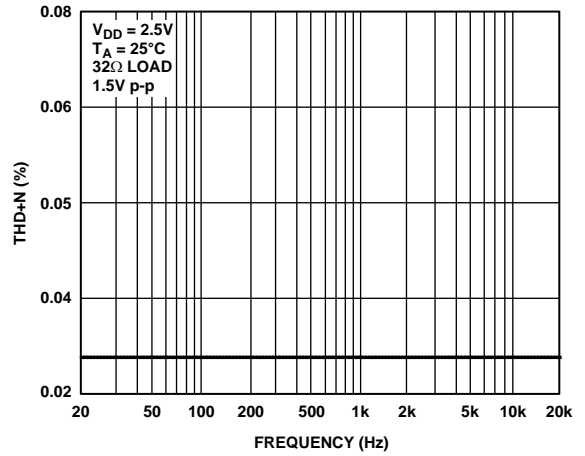

Figure 19. Total Harmonic Distortion Plus Noise (THD + N) vs. Frequency

04306-A-017

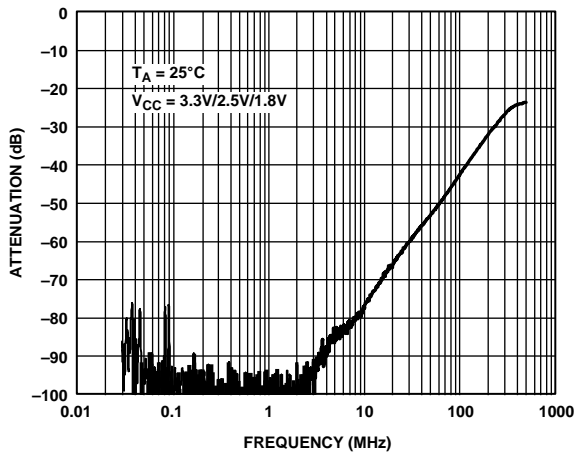

Figure 18. Off Isolation vs. Frequency

04306-A-016

TEST CIRCUITS

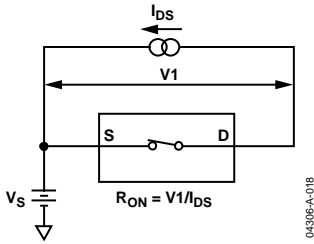

Figure 20. On Resistance

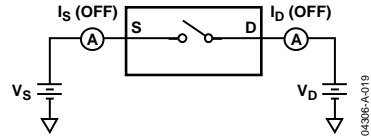

Figure 21. Off Leakage

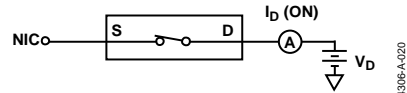

Figure 22. On Leakage

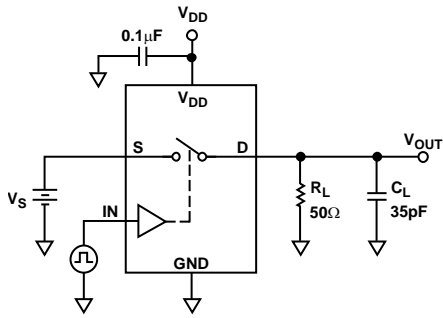

Figure 23. Switching Times

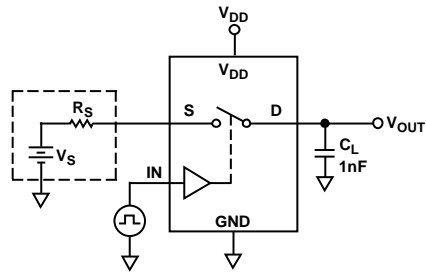
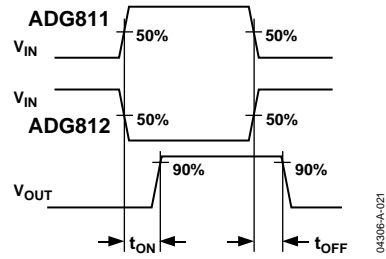
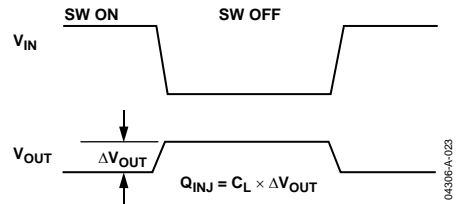

Figure 24. Charge Injection



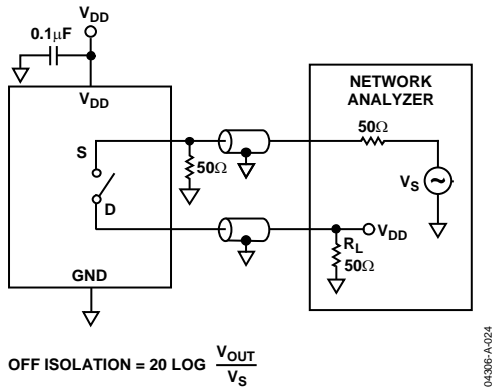

Figure 25. Off Isolation

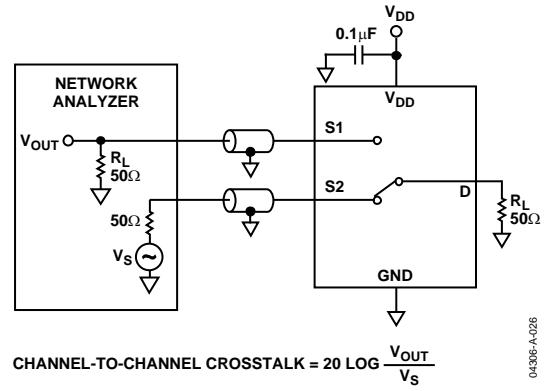

Figure 27. Channel-to-Channel Crosstalk

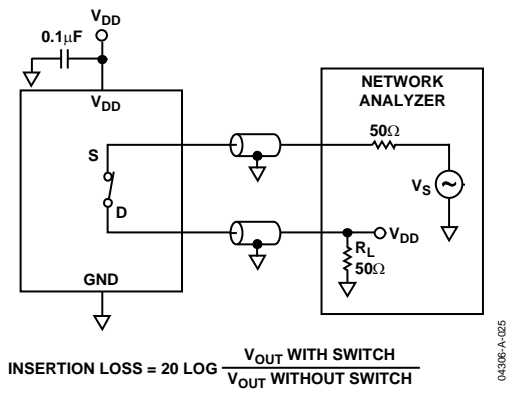

Figure 26. Bandwidth

## TERMINOLOGY

### $I_{DD}$

Positive supply current.

### $V_D, V_S$

Analog voltage on Terminal D and Terminal S.

### $R_{ON}$

Ohmic resistance between Terminal D and Terminal S.

### $R_{FLAT (ON)}$

Flatness is defined as the difference between the maximum and minimum value of on resistance as measured over the specified analog signal range.

### $\Delta R_{ON}$

On-resistance match between any two channels, that is,  $R_{ON}$  maximum –  $R_{ON}$  minimum.

### $I_S$ (Off)

Source leakage current with the switch off.

### $I_D$ (Off)

Drain leakage current with the switch off.

### $I_D, I_S$ (On)

Channel leakage current with the switch on.

### $V_{INL}$

Maximum input voltage for Logic 0.

### $V_{INH}$

Minimum input voltage for Logic 1.

### $I_{INL}$ ( $I_{INH}$ )

Input current of the digital input.

### $C_S$ (Off)

Off switch source capacitance. Measured with reference to ground.

### $C_D$ (Off)

Off switch drain capacitance. Measured with reference to ground.

### $C_D, C_S$ (On)

On switch capacitance. Measured with reference to ground.

### $C_{IN}$

Digital input capacitance.

### $t_{ON}$

Delay time between the 50% and the 90% points of the digital input and switch on condition.

### $t_{OFF}$

Delay time between the 50% and the 90% points of the digital input and switch off condition.

### $t_{BEM}$

On or off time measured between the 80% points of both switches, when switching from one to another.

### Charge Injection

A measure of the glitch impulse transferred from the digital input to the analog output during on-to-off switching.

### Off Isolation

A measure of unwanted signal coupling through an off switch.

### Crosstalk

A measure of unwanted signal that is coupled through from one channel to another because of parasitic capacitance.

### –3 dB Bandwidth

The frequency at which the output is attenuated by 3 dB.

### On Response

The frequency response of the on switch.

### Insertion Loss

The loss due to the on resistance of the switch.

### Total Harmonic Distortion Plus Noise (THD + N)

The ratio of the harmonic amplitudes plus the noise of a signal to the fundamental.

### OUTLINE DIMENSIONS

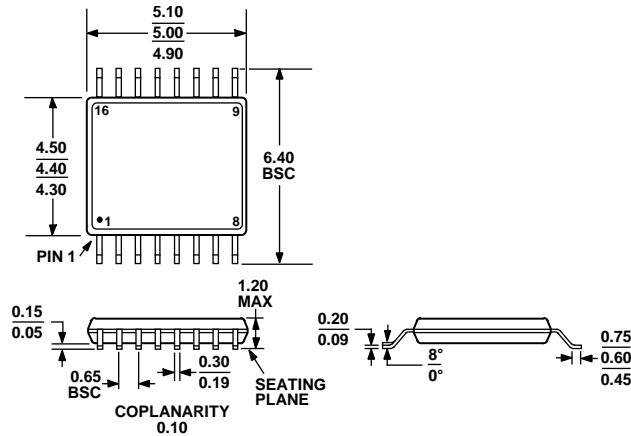

COMPLIANT TO JEDEC STANDARDS MO-153-AB

Figure 28. 16-Lead Thin Shrink Small Outline Package [TSSOP] (RU-16)

Dimensions shown in millimeters

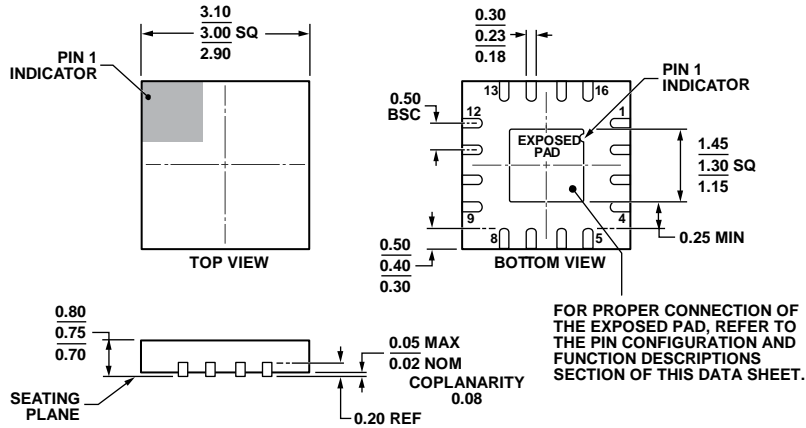

COMPLIANT TO JEDEC STANDARDS MO-220-WEED.

Figure 29. 16-Lead Lead Frame Chip Scale Package [LFCSP] 3 mm x 3 mm Body and 0.75 mm Package Height (CP-16-21)

Dimensions shown in millimeters

### ORDERING GUIDE

| Model <sup>1</sup> | Temperature Range | Package Description                           | Package Option |
|--------------------|-------------------|---|----------------|
| ADG811YRUZ         | -40°C to +125°C   | 16-Lead Thin Shrink Small Outline [TSSOP]     | RU-16          |
| ADG811YCPZ-REEL7   | -40°C to +125°C   | 16-Lead Lead Frame Chip Scale Package [LFCSP] | CP-16-21       |
| ADG812YRUZ         | -40°C to +125°C   | 16-Lead Thin Shrink Small Outline [TSSOP]     | RU-16          |
| ADG812YRUZ-REEL7   | -40°C to +125°C   | 16-Lead Thin Shrink Small Outline [TSSOP]     | RU-16          |

<sup>1</sup> Z = RoHS Compliant Part.

## X-ON Electronics

Largest Supplier of Electrical and Electronic Components

*Click to view similar products for [Analogue Switch ICs category](#):*

*Click to view products by [Analog Devices manufacturer](#):*

Other Similar products are found below :

[FSA3051TMX](#) [NLAS4684FCTCG](#) [NLAS5223BLMNR2G](#) [NLVAS4599DTT1G](#) [NLX2G66DMUTCG](#) [425541DB](#) [425528R](#) [099044FB](#)  
[NLAS5123MNR2G](#) [PI5A4599BCEX](#) [NLAS4717EPFCT1G](#) [PI5A3167CCEX](#) [SLAS3158MNR2G](#) [PI5A392AQE](#) [PI5A4157ZUEX](#)  
[PI5A3166TAEX](#) [FSA634UCX](#) [TC4066BP\(N,F\)](#) [DG302BDJ-E3](#) [PI5A100QEX](#) [HV2605FG-G](#) [HV2301FG-G](#) [RS2117YUTQK10](#)  
[RS2118YUTQK10](#) [RS2227XUTQK10](#) [ADG452BRZ-REEL7](#) [MAX4066ESD+](#) [MAX391CPE+](#) [MAX4730EXT+T](#) [MAX314CPE+](#)  
[BU4066BCFV-E2](#) [MAX313CPE+](#) [BU4S66G2-TR](#) [NLAS3158MNR2G](#) [NLASB3157MTR2G](#) [TS3A4751PWR](#) [NLAS4157DFT2G](#)  
[NLAS4599DFT2G](#) [NLAST4599DFT2G](#) [NLAST4599DTT1G](#) [DG300BDJ-E3](#) [DG2503DB-T2-GE1](#) [DG2502DB-T2-GE1](#)  
[TC4W53FU\(TE12L,F\)](#) [74HC2G66DC.125](#) [ADG619BRMZ-REEL](#) [ADG1611BRUZ-REEL7](#) [LTC201ACN#PBF](#) [74LV4066DB,118](#)  
[FSA2275AUMX](#)