

FEATURES

- Frequency domain triaxial vibration sensor**
- Digital acceleration data, $\pm 70 g$ measurement range**
- Digital range settings: 1 g, 5 g, 20 g, 70 g**
- Sample rate: 100.2 kHz, 4 decimation filter settings**
- FFT, 512 point, real valued, all three axes (x, y, z)**
- Windowing options: rectangular, Hanning, flat top**
- Programmable FFT averaging, up to 256 averages**
- Storage, 16 FFT records on all three axes (x, y, z)**
- Programmable alarms, 6 spectral bands**
- 2-level settings for warning and fault definition**
- Adjustable response delay to reduce false alarms**
- Trigger modes: SPI command, timer, external trigger**
- Multirecord capture for selected filter settings**
- Manual capture mode for time-domain data collection**
- Internal self-test with status flags**
- Digital temperature and power supply measurements**
- 2 auxiliary digital I/Os**
- SPI-compatible serial interface**
- Serial number and device ID**
- Single-supply operation: 3.15 V to 3.6 V**
- Operating temperature range: -40°C to $+125^{\circ}\text{C}$**
- 15 mm \times 15 mm \times 15 mm aluminum package, flex connector**

APPLICATIONS

- Vibration analysis**
- Condition monitoring**
- Machine health**
- Instrumentation, diagnostics**
- Safety shutoff sensing**

GENERAL DESCRIPTION

The ADIS16227 *iSensor*[®] is a complete vibration sensing system that combines wide bandwidth, triaxial acceleration sensing with advanced time domain and frequency domain signal processing. Time domain signal processing includes a programmable decimation filter and selectable windowing function. Frequency domain processing includes a 512 point, real-valued FFT for each axis, along with FFT averaging, which reduces the noise floor variation for finer resolution. The 16-record FFT storage system offers users the ability to track changes over time and to capture FFTs with multiple decimation filter settings.

The 22 kHz sensor resonance and 100.2 kSPS sample rate provide a frequency response that is suitable for machine-health applications. The aluminum core provides excellent mechanical coupling to the MEMS acceleration sensors. An internal clock drives the data sampling and signal processing system during all operations, which eliminates the need for an external clock source. The data capture function has three modes that offer several options to meet the needs of many different applications.

The SPI and data buffer structure provide convenient access to wide bandwidth sensor data. The ADIS16227 also offers a digital temperature sensor and digital power supply measurements.

The ADIS16227 is available in a 15 mm \times 15 mm \times 15 mm module with a threaded hole for stud mounting with a 10-32 UNF screw. The dual-row, 1 mm, 14-pin, flexible connector enables simple user interface and installation. The ADIS16227 is footprint and pin-for-pin compatible with the ADIS16223. It has an extended operating temperature range of -40°C to $+125^{\circ}\text{C}$.

FUNCTIONAL BLOCK DIAGRAM

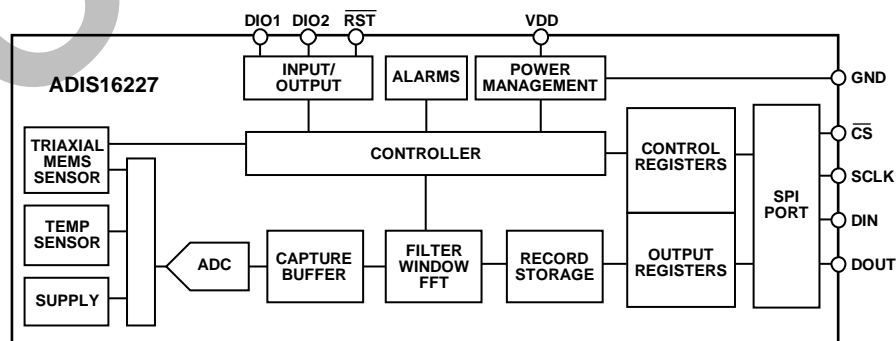

Figure 1.

Rev. B

Information furnished by Analog Devices is believed to be accurate and reliable. However, no responsibility is assumed by Analog Devices for its use, nor for any infringements of patents or other rights of third parties that may result from its use. Specifications subject to change without notice. No license is granted by implication or otherwise under any patent or patent rights of Analog Devices. Trademarks and registered trademarks are the property of their respective owners.

TABLE OF CONTENTS

Features	1	Spectral Alarms.....	13
Applications.....	1	Alarm Definition.....	13
General Description.....	1	Alarm Indicator Signals.....	14
Functional Block Diagram	1	Alarm Flags and Conditions.....	15
Revision History	2	Alarm Status.....	15
Specifications.....	3	Worst-Condition Monitoring.....	15
Timing Specifications	4	Reading Output Data	16
Absolute Maximum Ratings.....	5	Reading Data from the Data Buffer.....	16
ESD Caution.....	5	Accessing FFT Record Data.....	16
Pin Configuration and Function Descriptions.....	6	Data Format	16
Theory of Operation	7	Power Supply/Temperature.....	17
Sensing Element	7	FFT Event Header	17
Signal Processing.....	7	System Tools.....	18
User Interface.....	7	Global Commands.....	18
Basic Operation.....	8	Status/Error Flags.....	18
SPI Write Commands	8	Operation Management.....	18
SPI Read Commands	8	Input/Output Functions	19
Data Recording and Signal Processing.....	10	Self-Test	19
Recording Modes.....	10	Flash Memory Management.....	20
Recording Times.....	10	Device Identification.....	20
Power-Down	11	Applications Information.....	21
Record Storage Mode.....	11	Mounting Guidelines.....	21
Sample Rate Options.....	11	Getting Started.....	21
Windowing Options.....	11	Interface Board	21
Range.....	12	Outline Dimensions	22
Offset Correction.....	12	Ordering Guide	22
FFT Averaging	12		
FFT Record Flash Endurance	12		

REVISION HISTORY

5/12—Rev. A to Rev. B

Changes to Table 10.....	10
--------------------------	----

2/12—Rev. 0 to Rev. A

Changes to Dual Memory Structure Section.....	7
Change to Table 14	11

Changes to Alarm Trigger Settings Section, Enable Alarm Settings Section, Table 27, Table 28, Table 30, and

Table 31	14
Change to Alarm Indicator Section	19

10/10—Revision 0: Initial Version

SPECIFICATIONS

$T_A = -40^\circ\text{C}$ to $+125^\circ\text{C}$, $V_{DD} = 3.3\text{ V}$, unless otherwise noted.

Table 1.

Parameter	Test Conditions/Comments	Min	Typ	Max	Unit
ACCELEROMETERS					
Measurement Range	$T_A = 25^\circ\text{C}$	± 70			g
Sensitivity, FFT	$T_A = 25^\circ\text{C}$, 0 g to 70 g range setting		1.192		mg/LSB
Sensitivity, Time Domain	$T_A = 25^\circ\text{C}$		2.384		mg/LSB
Sensitivity Error	$T_A = 25^\circ\text{C}$		± 5		%
Nonlinearity	With respect to full scale		± 0.2	± 2	%
Cross-Axis Sensitivity			2.6		%
Alignment Error	With respect to package		1.5		Degree
Offset Error	$T_A = 25^\circ\text{C}$	-19.1		+19.1	g
Offset Temperature Coefficient			5		mg/ $^\circ\text{C}$
Output Noise	$T_A = 25^\circ\text{C}$, 100.2 kHz sample rate option		467		mg rms
Output Noise Density	$T_A = 25^\circ\text{C}$, 10 Hz to 1 kHz		3.3		mg/ $\sqrt{\text{Hz}}$
Bandwidth	X/Y-axes, $\pm 5\%$ flatness		7.75		kHz
	X/Y-axes, $\pm 10\%$ flatness		9.0		kHz
	Z-axis, $\pm 5\%$ flatness		13		kHz
	Z-axis, $\pm 10\%$ flatness		14.25		kHz
	-3 dB from 10 Hz magnitude		26		kHz
Sensor Resonant Frequency			22		kHz
LOGIC INPUTS¹					
Input High Voltage, V_{IH}		2.0			V
Input Low Voltage, V_{IL}				0.8	V
Logic 1 Input Current, I_{INH}	$V_{IH} = 3.3\text{ V}$		± 0.2	± 1	μA
Logic 0 Input Current, I_{INL}	$V_{IL} = 0\text{ V}$				μA
All Except $\overline{\text{RST}}$			-40	-60	μA
$\overline{\text{RST}}$			-1		mA
Input Capacitance, C_{IN}			10		pF
DIGITAL OUTPUTS¹					
Output High Voltage, V_{OH}	$I_{SOURCE} = 1.6\text{ mA}$	2.4			V
Output Low Voltage, V_{OL}	$I_{SINK} = 1.6\text{ mA}$			0.4	V
FLASH MEMORY					
Endurance ²		10,000			Cycles
Data Retention ³	$T_J = 85^\circ\text{C}$, see Figure 18	20			Years
START-UP TIME⁴					
Initial Startup			190		ms
Reset Recovery ⁵	$\overline{\text{RST}}$ pulse low or Register GLOB_CMD[7] = 1		54		ms
Sleep Mode Recovery			2.5		ms
CONVERSION RATE					
Clock Accuracy	REC_CTRL[11:8] = 0x1 (SR0 sample rate selection)		100.2		kSPS
			3		%
POWER SUPPLY					
Operating voltage range, V_{DD}		3.15	3.3	3.6	V
Power Supply Current	Record mode, $T_A = 25^\circ\text{C}$		43	52	mA
	Sleep mode, $T_A = 25^\circ\text{C}$		230		μA

¹ The digital I/O signals are 5 V tolerant.

² Endurance is qualified as per JEDEC Standard 22, Method A117, and measured at -40°C , $+25^\circ\text{C}$, $+85^\circ\text{C}$, and $+125^\circ\text{C}$.

³ Retention lifetime equivalent at junction temperature (T_J) = 85°C as per JEDEC Standard 22, Method A117. Retention lifetime depends on junction temperature.

⁴ The start-up times presented reflect the time it takes for data collection to begin.

⁵ The $\overline{\text{RST}}$ pin must be held low for at least 15 ns.

TIMING SPECIFICATIONS

T_A = 25°C, VDD = 3.3 V, unless otherwise noted.

Table 2.

Parameter	Description	Min ¹	Typ	Max	Unit
f _{SCLK}	SCLK frequency	0.01		2.25	MHz
t _{STALL}	Stall period between data, between 16 th and 17 th SCLK	15.4			μs
t _{CS}	Chip select to SCLK edge	48.8			ns
t _{DAV}	DOUT valid after SCLK edge			100	ns
t _{DSU}	DIN setup time before SCLK rising edge	24.4			ns
t _{DHD}	DIN hold time after SCLK rising edge	48.8			ns
t _{SR}	SCLK rise time			12.5	ns
t _{SF}	SCLK fall time			12.5	ns
t _{DF, tDR}	DOUT rise/fall times		5	12.5	ns
t _{SFS}	CS high after SCLK edge	5			ns

¹ Guaranteed by design, not tested.

Timing Diagrams

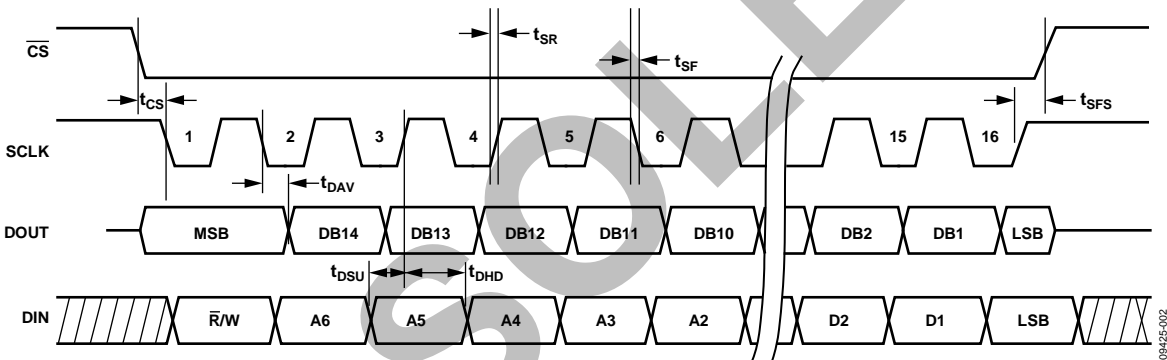

Figure 2. SPI Timing and Sequence

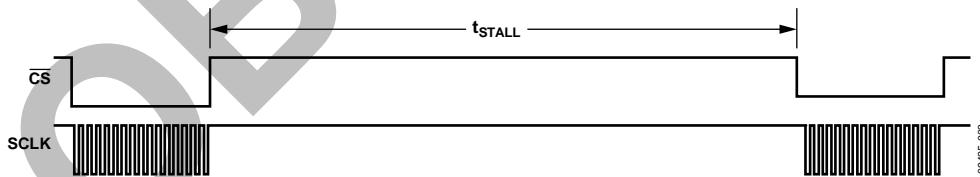

Figure 3. DIN Bit Sequence

ABSOLUTE MAXIMUM RATINGS

Table 3.

Parameter	Rating
Acceleration	
Any Axis, Unpowered	2000 <i>g</i>
Any Axis, Powered	2000 <i>g</i>
VDD to GND	−0.3 V to +6.0 V
Digital Input Voltage to GND	−0.3 V to +5.3 V
Digital Output Voltage to GND	−0.3 V to +3.6 V
Analog Inputs to GND	−0.3 V to +3.6 V
Operating Temperature Range	−40°C to +125°C
Storage Temperature Range	−65°C to +150°C

Stresses above those listed under Absolute Maximum Ratings may cause permanent damage to the device. This is a stress rating only; functional operation of the device at these or any other conditions above those indicated in the operational section of this specification is not implied. Exposure to absolute maximum rating conditions for extended periods may affect device reliability.

Table 4. Package Characteristics

Package Type	θ_{JA}	θ_{JC}	Device Weight
14-Lead Module	31°C/W	11°C/W	6.5 grams

ESD CAUTION



ESD (electrostatic discharge) sensitive device. Charged devices and circuit boards can discharge without detection. Although this product features patented or proprietary protection circuitry, damage may occur on devices subjected to high energy ESD. Therefore, proper ESD precautions should be taken to avoid performance degradation or loss of functionality.

PIN CONFIGURATION AND FUNCTION DESCRIPTIONS

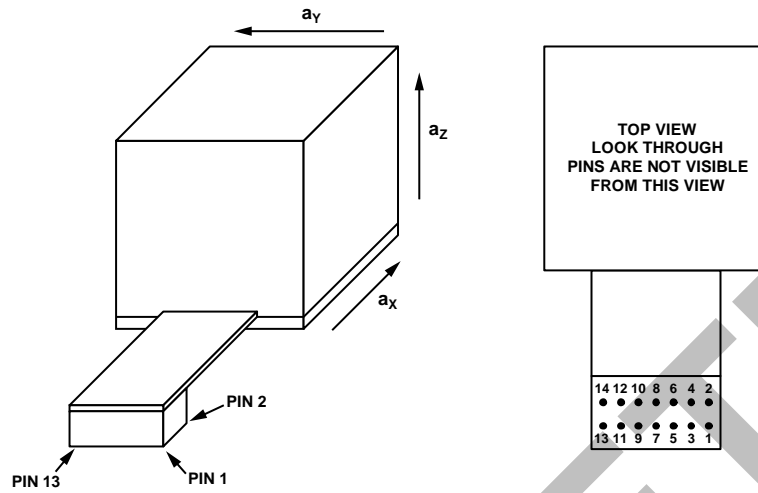

1. THE ARROWS ASSOCIATED WITH a_x , a_y , AND a_z DEFINE THE DIRECTION OF VELOCITY CHANGE THAT PRODUCES A POSITIVE OUTPUT IN ACCELERATION OUTPUT REGISTERS.
2. MATING CONNECTOR EXAMPLE: SAMTEC P/N CLM-107-02-LM-D-A.

0942E-004

Figure 4. Pin Configuration

Table 5. Pin Function Descriptions

Pin No.	Mnemonic	Type ¹	Description
1, 4, 9, 10	GND	S	Ground
2, 6	NC	I	No Connect
3	DIO2	I/O	Digital Input/Output Line 2
5	DIO1	I/O	Digital Input/Output Line 1
7	$\overline{\text{RST}}$	I	Reset, Active Low
8	VDD	S	Power Supply, 3.3 V
11	DIN	I	SPI, Data Input
12	DOUT	O ²	SPI, Data Output
13	SCLK	I	SPI, Serial Clock
14	$\overline{\text{CS}}$	I	SPI, Chip Select

¹ S is supply, O is output, I is input, and I/O is input/output.

² DOUT is an output when $\overline{\text{CS}}$ is low. When $\overline{\text{CS}}$ is high, DOUT is in a three-state, high impedance mode.

THEORY OF OPERATION

The ADIS16227 is a triaxial, wide bandwidth, vibration-sensing system. It combines a triaxial MEMS accelerometer with a sampling and advanced signal processing system. The SPI-compatible port and user register structure provide convenient access to frequency domain vibration data and many user controls.

SENSING ELEMENT

Digital vibration sensing in the ADIS16227 starts with a wide bandwidth MEMS accelerometer core on each axis, which provides a linear motion-to-electrical transducer function. Figure 5 provides a basic physical diagram of the sensing element and its response to linear acceleration. It uses a fixed frame and a moving frame to form a differential capacitance network that responds to linear acceleration. Tiny springs tether the moving frame to the fixed frame and govern the relationship between acceleration and physical displacement. A modulation signal on the moving plate feeds through each capacitive path into the fixed frame plates and into a demodulation circuit, which produces the electrical signal that is proportional to the acceleration acting on the device.

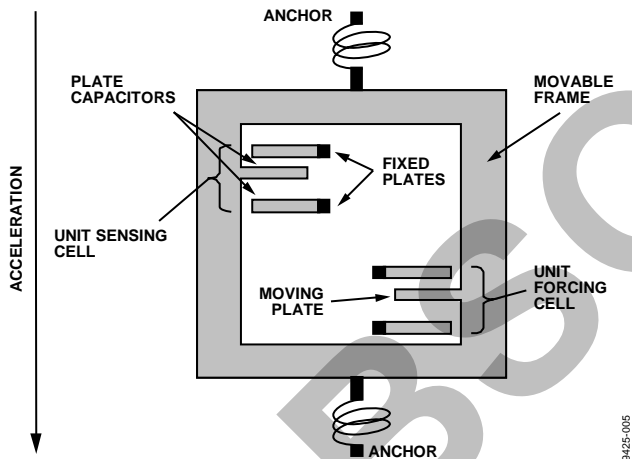

Figure 5. MEMS Sensor Diagram

SIGNAL PROCESSING

Figure 6 offers a simplified block diagram for the ADIS16227. The signal processing stage includes time domain data capture, digital decimation/filtering, windowing, FFT analysis, FFT averaging, and record storage. See Figure 13 for more details on the signal processing operation.

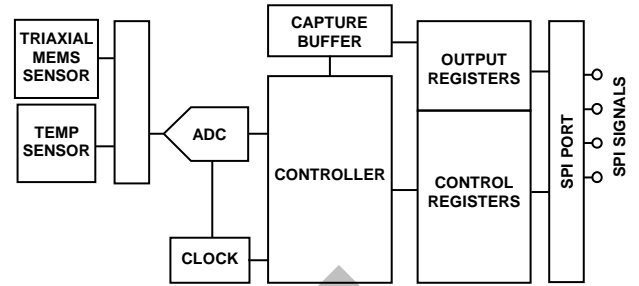

Figure 6. Simplified Sensor Signal Processing Diagram

USER INTERFACE

SPI Interface

The user registers manage user access to both sensor data and configuration inputs. Each 16-bit register has its own unique bit assignment and two addresses: one for its upper byte and one for its lower byte. Table 8 provides a memory map for each register, along with its function and lower byte address. The data collection and configuration command uses the SPI, which consists of four wires. The chip select (\overline{CS}) signal activates the SPI interface, and the serial clock (SCLK) synchronizes the serial data lines. Input commands clock into the DIN pin, one bit at a time, on the SCLK rising edge. Output data clocks out of the DOUT pin on the SCLK falling edge. When the SPI is used as a slave device, the DOUT contents reflect the information requested using a DIN command.

Dual Memory Structure

The user registers provide addressing for all input/output operations in the SPI interface. The control registers use a dual memory structure. The controller uses SRAM registers for normal operation, including user-configuration commands. The flash memory provides nonvolatile storage for control registers that have flash backup (see Table 8). Storing configuration data in the flash memory requires a manual flash update command (GLOB_CMD[6] = 1, DIN = 0xBE40). When the device powers on or resets, the flash memory contents load into the SRAM, and the device starts producing data according to the configuration in the control registers.

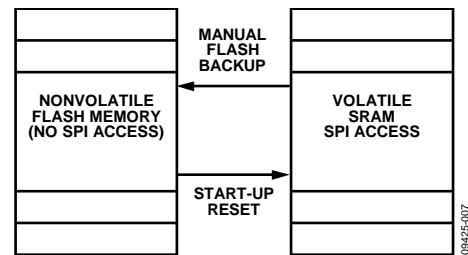

Figure 7. SRAM and Flash Memory Diagram

BASIC OPERATION

The ADIS16227 uses a SPI for communication, which enables a simple connection with a compatible, embedded processor platform, as shown in Figure 8. The factory default configuration for DIO1 provides a busy indicator signal that transitions low when an event completes and data is available for user access. Use the DIO_CTRL register (see Table 59) to reconfigure DIO1 and DIO2, if necessary.

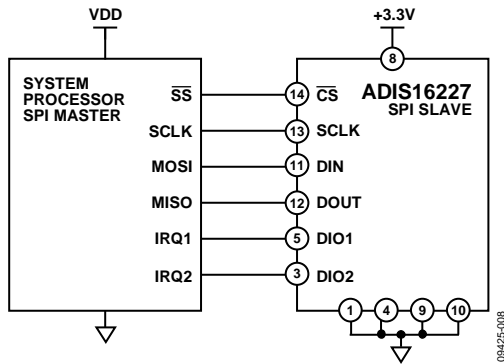

Figure 8. Electrical Hook-Up Diagram

Table 6. Generic Master Processor Pin Names and Functions

Pin Name	Function
SS	Slave select
IRQ1, IRQ2	Interrupt request inputs (optional)
MOSI	Master output, slave input
MISO	Master input, slave output
SCLK	Serial clock

The ADIS16227 SPI interface supports full duplex serial communication (simultaneous transmit and receive) and uses the bit sequence shown in Figure 12. Table 7 provides a list of the most common settings that require attention to initialize a processor serial port for the ADIS16227 SPI interface.

Table 7. Generic Master Processor SPI Settings

Processor Setting	Description
Master	ADIS16227 operates as a slave.
SCLK Rate ≤ 2.25 MHz	Bit rate setting.
SPI Mode 3	Clock polarity/phase (CPOL = 1, CPHA = 1).
MSB-First	Bit sequence.
16-Bit	Shift register/data length.

Table 8 provides a list of user registers with their lower byte addresses. Each register consists of two bytes that each have their own, unique 7-bit addresses. Figure 9 relates each register's bits to their upper and lower addresses.

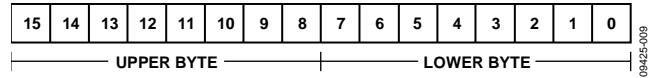

Figure 9. Generic Register Bit Definitions

SPI WRITE COMMANDS

User control registers govern many internal operations. The DIN bit sequence in Figure 12 provides the ability to write to these registers, one byte at a time. Some configuration changes and functions require only one write cycle. For example, set GLOB_CMD[11] = 1 (DIN = 0xBF08) to start a manual capture sequence. The manual capture starts immediately after the last bit clocks into DIN (16th SCLK rising edge). Other configurations may require writing to both bytes.

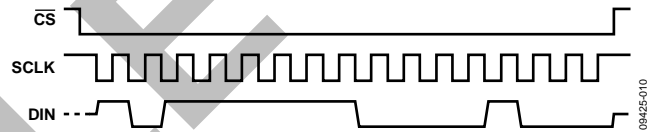

Figure 10. SPI Sequence for Manual Capture Start (DIN = 0xBF08)

SPI READ COMMANDS

A single register read requires two 16-bit SPI cycles that also use the bit assignments in Figure 12. The first sequence sets R/W = 0 and communicates the target address (Bits[A6:A0]). Bits[D7:D0] are don't care bits for a read DIN sequence. DOUT clocks out the requested register contents during the second sequence. The second sequence can also use DIN to set up the next read. Figure 11 provides a signal diagram for all four SPI signals while reading the PROD_ID register (see Table 63) pattern. In this diagram, DIN = 0x5600 and DOUT reflect the decimal equivalent of 16,227.

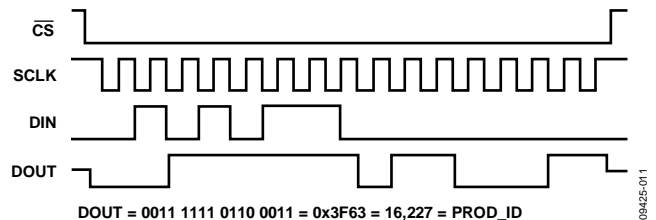
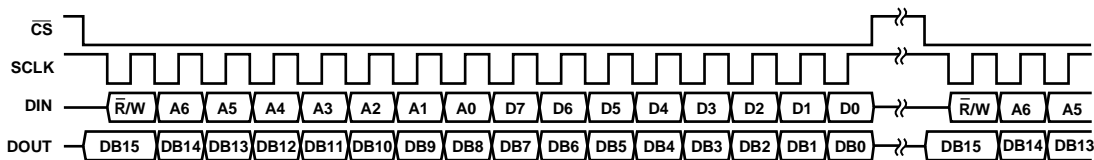

Figure 11. Example SPI Read, PROD_ID, Second Sequence



NOTES

1. DOUT BITS ARE BASED ON THE PREVIOUS 16-BIT SEQUENCE (R/W = 0).

Figure 12. Example SPI Read Sequence

Table 8. User Register Memory Map

Register Name	Access	Flash Backup	Address	Default	Function	Reference
FLASH_CNT	Read only	Yes	0x00	N/A	Status, flash memory write count	Table 61
X_NULL	Read only	Yes	0x02	0x0000	X-axis accelerometer offset correction	Table 18
Y_NULL	Read only	Yes	0x04	0x0000	Y-axis accelerometer offset correction	Table 18
Z_NULL	Read only	Yes	0x06	0x0000	Z-axis accelerometer offset correction	Table 18
REC_FLSH_CNT	N/A	No	0x08	N/A	Record flash write/erase counter	Table 20
SUPPLY_OUT	Read only	Yes	0x0A	0x8000	Output, power supply during capture	Table 48
TEMP_OUT	Read only	Yes	0x0C	0x8000	Output, temperature during capture	Table 50
FFT_AVG	Read/write	Yes	0x0E	0x0008	Control, number of FFT records to average	Table 19
BUF_PNTR	Read/write	Yes	0x10	0x0000	Control, buffer address pointer	Table 43
REC_PNTR	Read/write	Yes	0x12	0x0000	Control, record address pointer	Table 44
X_BUF	Read only	No	0x14	0x8000	Output, buffer for x-axis acceleration data	Table 45
Y_BUF	Read only	No	0x16	0x8000	Output, buffer for y-axis acceleration data	Table 45
Z_BUF	Read only	No	0x18	0x8000	Output, buffer for z-axis acceleration data	Table 45
REC_CNTR	Read/write	No	0x1A	0x0000	Control, record counter	Table 13
REC_CTRL	Read/write	Yes	0x1C	0x1130	Control, record control register	Table 10
REC_PRD	Read/write	Yes	0x1E	0x0000	Control, record period (automatic mode)	Table 11
ALM_F_LOW	Read/write	N/A	0x20	0x0000	Alarm, spectral band lower frequency limit	Table 24
ALM_F_HIGH	Read/write	N/A	0x22	0x0000	Alarm, spectral band upper frequency limit	Table 25
ALM_X_MAG1	Read/write	N/A	0x24	0x0000	Alarm, x-axis, Alarm 1 level	Table 26
ALM_Y_MAG1	Read/write	N/A	0x26	0x0000	Alarm, y-axis, Alarm 1 level	Table 27
ALM_Z_MAG1	Read/write	N/A	0x28	0x0000	Alarm, z-axis, Alarm 1 level	Table 28
ALM_X_MAG2	Read/write	N/A	0x2A	0x0000	Alarm, x-axis, Alarm 2 level	Table 29
ALM_Y_MAG2	Read/write	N/A	0x2C	0x0000	Alarm, y-axis, Alarm 2 level	Table 30
ALM_Z_MAG2	Read/write	N/A	0x2E	0x0000	Alarm, z-axis, Alarm 2 level	Table 31
ALM_PNTR	Read/write	Yes	0x30	0x0000	Alarm, spectral alarm band pointer	Table 23
ALM_S_MAG	Read/write	Yes	0x32	0x0000	Alarm, system alarm level	Table 32
ALM_CTRL	Read/write	Yes	0x34	0x0080	Alarm, configuration	Table 22
DIO_CTRL	Read/write	Yes	0x36	0x000F	Control, functional I/O configuration	Table 59
GPIO_CTRL	Read/write	Yes	0x38	0x0000	Control, general-purpose I/O	Table 60
Reserved	N/A	N/A	0x3A	N/A	Reserved	N/A
DIAG_STAT	Read only	No	0x3C	0x0000	Status, system error flags	Table 58
GLOB_CMD	Write only	No	0x3E	N/A	Control, global command register	Table 57
ALM_X_STAT	Read only	N/A	0x40	0x0000	Alarm, x-axis, status for spectral alarm bands	Table 33
ALM_Y_STAT	Read only	N/A	0x42	0x0000	Alarm, y-axis, status for spectral alarm bands	Table 34
ALM_Z_STAT	Read only	N/A	0x44	0x0000	Alarm, z-axis, status for spectral alarm bands	Table 35
ALM_X_PEAK	Read only	N/A	0x46	0x0000	Alarm, x-axis, peak value (most severe alarm)	Table 36
ALM_Y_PEAK	Read only	N/A	0x48	0x0000	Alarm, y-axis, peak value (most severe alarm)	Table 37
ALM_Z_PEAK	Read only	N/A	0x4A	0x0000	Alarm, z-axis, peak value (most severe alarm)	Table 38
TIME_STAMP_L	Read only	N/A	0x4C	0x0000	Record time stamp, lower word	Table 54
TIME_STAMP_H	Read only	N/A	0x4E	0x0000	Record time stamp, upper word	Table 55
Reserved	N/A	N/A	0x50 to 0x51	N/A	Reserved	N/A
LOT_ID1	Read only	Yes	0x52	N/A	Lot identification code	Table 62
LOT_ID2	Read only	Yes	0x54	N/A	Lot identification code	Table 62
PROD_ID	Read only	Yes	0x56	0x3F63	Product identifier; convert to decimal = 16,227	Table 63
SERIAL_NUM	Read only	Yes	0x58	N/A	Serial number	Table 64
ALM_X_FREQ	Read only	N/A	0x70	0x0000	Alarm, x-axis, frequency of most severe alarm	Table 39
ALM_Y_FREQ	Read only	N/A	0x72	0x0000	Alarm, y-axis, frequency of most severe alarm	Table 40
ALM_Z_FREQ	Read only	N/A	0x74	0x0000	Alarm, z-axis, frequency of most severe alarm	Table 41
REC_INFO	Read only	N/A	0x76	N/A	Record settings	Table 53

DATA RECORDING AND SIGNAL PROCESSING

The ADIS16227 provides a number of registers for configuring its data collection and signal processing operation (see Table 9). Figure 13 provides a signal flow diagram, which describes many of these settings.

Table 9. Sampling/Signal Processing Register Summary

Register	Address	Description
X_NULL	0x02	X-axis offset correction
Y_NULL	0x04	Y-axis offset correction
Z_NULL	0x06	Z-axis offset correction
REC_FLSH_CNT	0x08	Record, flash write cycle counter
FFT_AVG	0x0E	Record, FFT averages
REC_CNTR	0x1A	Record, counter
REC_CTRL	0x1C	Record, data processing
REC_PRD	0x1E	Record, automatic mode period
GLOB_CMD	0x3E	Trigger, record commands

The record control register is REC_CTRL (see Table 10), which provides external controls for sample rates, dynamic range, record storage, recording mode, and power management.

Table 10. REC_CTRL Bit Descriptions

Bits	Description (Default = 0x1130)
[15:14]	Not used
[13:12]	Window setting: 00 = rectangular, 01 = Hanning, 10 = flat top, 11 = N/A
[11]	SR3, $f_s \div 512$ (1 = enabled for analysis)
[10]	SR2, $f_s \div 64$ (1 = enabled for analysis)
[9]	SR1, $f_s \div 8$ (1 = enabled for analysis)
[8]	SR0, f_s (1 = enabled for analysis)
[7]	Power-down between each recording (1 = enabled)
[6]	Not used
[5:4]	Signal range: 00 = 0 g to 1 g, 01 = 0 g to 5 g, 10 = 0 g to 20 g, 11 = 0 g to 70 g
[3:2]	Storage method: 00 = none, 01 = alarm trigger, 10 = all, 11 = N/A
[1:0]	Recording mode: 00 = manual, 01 = automatic, 10 = manual time, 11 = N/A

RECORDING MODES

REC_CTRL[1:0] provides three modes for triggering: (1) manual, (2) automatic, and (3) manual time domain. The manual and automatic modes produce FFT events, which include data collection, filtering, windowing, FFT analysis, and record storage (if selected). The manual time domain mode produces time-domain data in the buffer. All three modes require an external trigger, using either the SPI interface or one of the auxiliary digital I/O lines, DIO1 or DIO2. For the SPI external trigger option, set GLOB_CMD[11] = 1 (DIN = 0x3F08). For the digital I/O option, use the DIO_CTRL register (see Table 59) to configure either DIO1 or DIO2 as an external trigger input.

For example, set DIO_CTRL[7:0] = 0x2F (DIN = 0xB62F) to configure DIO2 as a positive external trigger input and maintain the DIO1 factory default configuration as a positive busy indicator. In manual mode, the start command triggers a recording for an averaged FFT and stops after the recording is complete. In automatic mode, the start command executes a recording, and a timer continues to trigger recordings based on the record period setting in REC_PRD (see Table 11).

Table 11. REC_PRD Register Bit Descriptions

Bits	Description (Default = 0x0000)
[15:10]	Not used
[9:8]	Scale for data bits 00 = 1 second/LSB 01 = 1 minute/LSB 10 = 1 hour/LSB
[7:0]	Data bits, binary format, range = 0 to 255

RECORDING TIMES

The automatic recording period (REC_PRD) must be greater than the total recording time. Use the following equations to calculate the recording time:

Manual time mode

$$T_R = T_S + T_{PT} + T_{ST} + T_{AST}$$

FFT modes

$$T_R = N_F \times (T_S + T_{PT} + T_{FFT}) + T_{ST} + T_{AST}$$

The storage time (T_{ST}) applies only when a storage method is selected in REC_CTRL[3:2]. See Table 10 for more details on the record storage setting. The alarm scan time (T_{AST}) applies only when the alarms are enabled in ALM_CTRL[4:0]. See Table 22 for more details on enabling the alarms.

Table 12. Available Records

Function	Time (ms)
Sample Time, T_S	See Table 15
Processing Time, T_{PT}	10.4
FFT Time, T_{FFT}	26.6
Number of FFT Averages, N_F	See Table 19
Storage Time, T_{ST}	120.0
Alarm Scan Time, T_{AST}	2.21

POWER-DOWN

Set GLOB_CMD[1] = 1 (DIN = 0xBE02) to power down the ADIS16227. To reduce power consumption, set REC_CTRL[7] = 1 to automatically power down after a record has completed. Toggle the \overline{CS} line from high to low to wake the device up and place it in an idle state, where it waits for the next command. When configured as an external trigger option, toggling DIO1 or DIO2 can wake the device up as well. Using DIO1 or DIO2 for this purpose avoids the potential for multiple devices contending for DOUT when waking up with the \overline{CS} line approach. After completing the record cycle, the device remains awake. Use GLOB_CMD[1] to put it back to sleep after reading the record data.

RECORD STORAGE MODE

After the ADIS16227 finishes processing FFT data, it stores the data into the FFT buffer, where it is available for external access using the SPI and x_BUF registers. REC_CTRL[3:2] provides programmable conditions for writing buffer data into the FFT records, which are in nonvolatile flash memory locations. Set REC_CTRL[3:2] = 01 to store FFT buffer data into the flash memory records only when an alarm condition is met. Set REC_CTRL[3:2] = 10 to store every set of FFT data into the flash memory locations. The flash memory record provides space for a total of 16 records. Each record stored in flash memory contains a header and frequency domain (FFT) data from all three axes (x, y, and z). When all 16 records are full, new records do not load into the flash memory. The REC_CNTR register (see Table 13) provides a running count for the number of records that are stored. Set GLOB_CMD[8] = 1 (DIN = 0xBF01) to clear all of the records in flash memory.

Table 13. REC_CNTR Bit Descriptions

Bits	Description (Default = 0x0000)
[15:5]	Not used
[4:0]	Total number of records taken, range = 0 to 16, binary

SAMPLE RATE OPTIONS

The analog-to-digital converter (ADC) samples each accelerometer sensor at a rate of 100.2 kSPS (f_s). REC_CTRL[11:8] provide four different sample rate options for FFT analysis: SR0 (f_s), SR1 ($f_s \div 8$), SR2 ($f_s \div 64$), and SR3 ($f_s \div 512$). The reduced rates come from a decimation filter, which reduces the bandwidth and bin widths. See Figure 13 for the filter location in the signal processing diagram and Table 14 for the performance trade-offs associated with each sample rate setting.

Table 14. Sample Rate Settings and Filter Performance

Setting	Sample Rate (SPS)	Bin Width (Hz)	Bandwidth (Hz)	Noise (mg)
SR0	100,189	196	26,000	467
SR1	12,524	25	6,262	260
SR2	1566	3.1	783	100
SR3	196	0.38	98	38

Table 15 provides the data sampling time (T_s) for each sample rate setting. This represents the time it takes to record data for all three axes of vibration data.

Table 15. Sample Times, T_s

Sample Rate Setting	Sample Time (ms), T_s
SR0, REC_CTRL[8] = 1	5.27
SR1, REC_CTRL[9] = 1	42.15
SR2, REC_CTRL[10] = 1	337.17
SR3, REC_CTRL[11] = 1	2697.39

If more than one sample rate setting is active in REC_CTRL[11:8], the sample rate setting automatically updates after each FFT event and waits for the next trigger input. The order of priority starts with the highest sample rate enabled and works toward the lowest after each REC_CTRL[11:8] write cycle. When used in conjunction with automatic trigger mode and record storage, FFT analysis for each sample rate option requires no further user inputs, except for collecting the data. Depending on the number of FFT averages, the time period between each sample rate selection may be quite large. Note that selecting multiple sample rates reduces the number of records available for each sample rate setting, as shown in Table 16.

Table 16. Available Records

Number of Sample Rates Selected	Available Records
1	16
2	8
3	5
4	4

WINDOWING OPTIONS

REC_CTRL[13:12] provide three options for pre-FFT windowing of time data. For example, set REC_CTRL[13:12] = 01 to use the Hanning window, which offers the best amplitude resolution of the peaks between frequency bins and minimal broadening of peak amplitudes. The rectangular and flat top windows are also available because they are common windowing options for vibration monitoring. The flat top window provides accurate amplitude resolution with a trade-off of broadening the peak amplitudes.

RANGE

REC_CTRL[5:4] provide four range options for scaling acceleration data prior to the FFT analysis stage. For example, set REC_CTRL[5:4] = 10 to set the peak acceleration (A_{MAX}) to 5 g. See Table 17 for the resolution associated with each setting and Figure 13 for the location of this operation in the signal flow diagram.

Table 17. Range Setting and LSB Weights

Range Setting (g) (REC_CTRL[5:4])	Time Mode (mg/LSB)	FFT Mode (mg/LSB)
0 to 1	0.0305	0.0153
0 to 5	0.1526	0.0763
0 to 20	0.6104	0.3052
0 to 70	2.3842	1.1921

OFFSET CORRECTION

The x_NULL registers (see Table 18) contain the offset correction factors generated when using the internal, autonull command. They represent the K_o factor in Figure 13 and follow the digital format in Table 18. Set GLOB_CMD[0] = 1 (DIN = 0xBE01) and wait for 681 ms to execute this function.

Table 18. X_NULL, Y_NULL, and Z_NULL Bit Descriptions

Bits	Description (Default = 0x0000)
[15:0]	Offset correction factor, twos complement, 2.3842 mg/LSB

FFT AVERAGING

The FFT averaging function records a programmable number of FFTs and combines them into a single, averaged FFT record. This function is useful in reducing the variation of the FFT noise floor, which enables detection of lower vibration levels. To enable this function, write the number of averages to FFT_AVG. Setting FFT_AVG = 0x0000 has the same effect as setting FFT_AVG = 0x0001: no averaging. Setting $FFT_AVG \geq 0x0100$ results in a setting of 256. Therefore, set $FFT_AVG[15:8] = 0x01$ (DIN = 0x8F01) to establish the maximum average setting of 256. Another example configuration is to set $FFT_AVG = 0x00F0$ (DIN = 0x8F00, DIN = 0x8EF0) to establish an average setting of 240.

Table 19. FFT_AVG Register Bit Descriptions

Bits	Description (Default = 0x0008)
[15:9]	Not used
[8:0]	Number of FFT averages for a single record, N_f in Figure 13, range = 1 to 256, binary

FFT RECORD FLASH ENDURANCE

The REC_FLASH_CNT register (see Table 20) increments each time that all 16 records have FFT data.

Table 20. REC_FLASH_CNT Bit Descriptions

Bits	Description
[15:0]	Flash write cycle count, record data only, binary

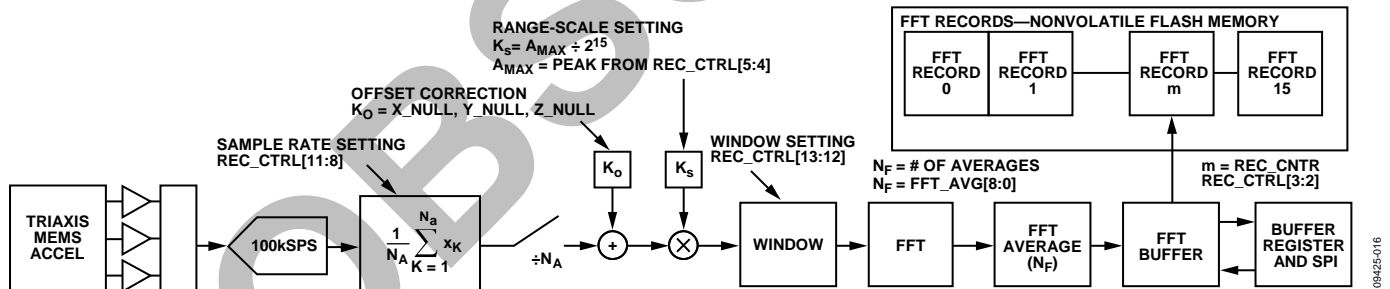

Figure 13. Signal Flow Diagram, REC_CTRL[1:0] = 00 or 01, FFT Analysis Modes

SPECTRAL ALARMS

The alarm function offers six spectral bands for alarm detection. Each spectral band has high and low frequency definitions, along with two different trigger thresholds (Alarm 1 and Alarm 2) for each accelerometer axis. Table 21 provides a summary of each register used to configure the alarm function.

Table 21. Alarm Function Register Summary

Register	Address	Description
ALM_F_LOW	0x20	Alarm frequency, lower limit
ALM_F_HIGH	0x22	Alarm frequency, upper limit
ALM_X_MAG1	0x24	X-Alarm Trigger Level 1 (warning)
ALM_Y_MAG1	0x26	Y-Alarm Trigger Level 1 (warning)
ALM_Z_MAG1	0x28	Z-Alarm Trigger Level 1 (warning)
ALM_X_MAG2	0x2A	X-Alarm Trigger Level 2 (fault)
ALM_Y_MAG2	0x2C	Y-Alarm Trigger Level 2 (fault)
ALM_Z_MAG2	0x2E	Z-Alarm Trigger Level 2 (fault)
ALM_PNTR	0x30	Alarm pointer
ALM_S_MAG	0x32	System alarm trigger level
ALM_CTRL	0x34	Alarm configuration
DIAG_STAT	0x3C	Alarm status
ALM_X_STAT	0x40	X-alarm status
ALM_Y_STAT	0x42	Y-alarm status
ALM_Z_STAT	0x44	Z-alarm status
ALM_X_PEAK	0x46	X-alarm peak
ALM_Y_PEAK	0x48	Y-alarm peak
ALM_Z_PEAK	0x4A	Z-alarm peak
ALM_X_FREQ	0x70	X-axis alarm frequency of peak alarm
ALM_Y_FREQ	0x72	Y-axis alarm frequency of peak alarm
ALM_Z_FREQ	0x74	Z-axis alarm frequency of peak alarm

The ALM_CTRL register (see Table 22) provides control bits that enable each axis' spectral alarms, configures the system alarm, sets the record delay for the spectral alarms, and configures the clearing function for the DIAG_STAT error flags.

Table 22. ALM_CTRL Bit Descriptions

Bits	Description (Default = 0x0080)
[15:12]	Not used
[11:8]	Response delay, range: 0 to 15; represents the number of spectral records for each spectral alarm before a spectral alarm flag is set high
[7]	Latch DIAG_STAT error flags, which requires a clear status command (GLOB_CMD[4]) to reset the flags to 0 (1 = enabled, 0 = disabled)
[6]	Enable DIO1 as an Alarm 1 output indicator and enable DIO2 as an Alarm2 output indicator (1 = enabled)
[5]	System alarm comparison polarity 1 = trigger when less than ALM_MAGS[11:0] 0 = trigger when greater than ALM_MAGS[11:0]
[4]	System alarm, 1 = temperature 0 = power supply
[3]	Alarm S enable (ALM_S_MAG), 1 = enabled, 0 = disabled
[2]	Alarm Z enable (ALM_Z_MAG), 1 = enabled, 0 = disabled
[1]	Alarm Y enable (ALM_Y_MAG), 1 = enabled, 0 = disabled
[0]	Alarm X enable (ALM_X_MAG), 1 = enabled, 0 = disabled

ALARM DEFINITION

The alarm function provides six programmable spectral bands, as shown in Figure 14. Each spectral alarm band has lower and upper frequency definitions for all four sample rate options. It also has two independent trigger level settings, which are useful for systems that value warning and fault condition indicators.

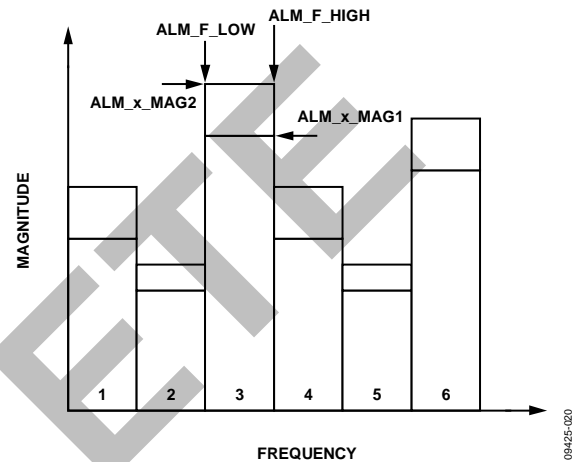

Figure 14. Spectral Band Alarm Setting Example, ALM_PNTR = 0x03

Select the spectral band for configuration by writing its number (1 to 6) to ALM_PNTR[2:0] (see Table 23). Then, select the sample rate setting using ALM_PNTR[9:8]. This number represents a binary number, which corresponds to the x in the SRx sample rates settings associated with REC_CTRL[11:8] (see Table 10). For example set ALM_PNTR[7:0] = 0x05 (DIN = 0xB005) to select Alarm Spectral Band 5 and set ALM_PNTR[15:8] = 0x02 (DIN = 0xB102) to select the SR2 sample rate option from Table 14, 1,566 SPS.

Table 23. ALM_PNTR Bit Assignments

Bits	Description (Default = 0x0000)
[15:10]	Not used
[9:8]	Sample rate setting, range: 0 to 3
[7:3]	Not used
[2:0]	Spectral band number, range: 1 to 6

Alarm Band Frequency Definitions

After the spectral band and sample rate settings are set, program the lower and upper frequency boundaries by writing their bin numbers to the ALM_F_LOW (see Table 24) and ALM_F_HIGH (see Table 25) registers. Use the bin width definitions in Table 14 to convert a frequency into a bin number for this definition. Calculate the bin number by dividing the frequency by the bin width associated with the sample rate setting. For example, 3400 Hz, divided by 196 Hz/bin (SR0 setting), rounded to the nearest integer, is equal to 17, or 0x12. Therefore, set ALM_F_LOW[7:0] = 0x11 (DIN = 0xA011) to establish 3400 Hz as the lower frequency for the SR0 sample rate setting.

Table 24. ALM_F_LOW Bit Assignments

Bits	Description (Default = 0x0000)
[15:8]	Not used
[7:0]	Lower frequency, bin number, range = 0 to 255

Table 25. ALM_F_HIGH Bit Assignments

Bits	Description (Default = 0x0000)
[15:8]	Not used
[7:0]	Upper frequency, bin number, range = 0 to 255

Alarm Trigger Settings

The ALM_x_MAG1 and ALM_x_MAG2 registers provide two independent trigger settings for all three axes of acceleration data. They use the data format established by the range setting in REC_CTRL[5:4] and recording mode in REC_CTRL[1:0]. For example, when using the 0 g to 1 g mode for FFT analysis, 3277 LSB is equivalent to 500.07 mg. To set the critical alarm to 500.07 mg when using the 0 g to 1 g range option in REC_CTRL2 for FFT records, set ALM_X_MAG2 = 0x0CCD (DIN = 0xAD0C, 0xACCD). See Table 10 and Table 17 for more information on formatting each trigger level. Note that trigger settings associated with Alarm 2 should be greater than the trigger settings for Alarm 1. In other words, the alarm magnitude settings should meet the following criteria:

ALM_X_MAG2 > ALM_X_MAG1
 ALM_Y_MAG2 > ALM_Y_MAG1
 ALM_Z_MAG2 > ALM_Z_MAG1

Table 26. ALM_X_MAG1 Bit Assignments

Bits	Description (Default = 0x0000)
[15:0]	X-axis Alarm Trigger Level 1, 16-bit unsigned; see REC_CTRL[5:4] and Table 17 for the scale factor

Table 27. ALM_Y_MAG1 Bit Assignments

Bits	Description (Default = 0x0000)
[15:0]	Y-axis Alarm Trigger Level 1, 16-bit unsigned; see REC_CTRL[5:4] and Table 17 for the scale factor

Table 28. ALM_Z_MAG1 Bit Assignments

Bits	Description (Default = 0x0000)
[15:0]	Z-axis Alarm Trigger Level 1, 16-bit unsigned; see REC_CTRL[5:4] and Table 17 for the scale factor

Table 29. ALM_X_MAG2 Bit Assignments

Bits	Description (Default = 0x0000)
[15:0]	X-axis Alarm Trigger Level 2, 16-bit unsigned; see REC_CTRL[5:4] and Table 17 for the scale factor

Table 30. ALM_Y_MAG2 Bit Assignments

Bits	Description (Default = 0x0000)
[15:0]	Y-axis Alarm Trigger Level 2, 16-bit unsigned; see REC_CTRL[5:4] and Table 17 for the scale factor

Table 31. ALM_Z_MAG2 Bit Assignments

Bits	Description (Default = 0x0000)
[15:0]	Z-axis Alarm Trigger Level 2, 16-bit unsigned; see REC_CTRL[5:4] and Table 17 for the scale factor

Table 32. ALM_S_MAG Bit Assignments

Bits	Description (Default = 0x0000)
[15:0]	System alarm trigger level, data format matches target from ALM_CTRL[4]

Enable Alarm Settings

Before configuring the spectral alarm registers, clear their current contents by setting GLOB_CMD[9] = 1 (DIN = 0xBF02). After completing the spectral alarm band definitions, enable the settings by setting GLOB_CMD[12] = 1 (DIN = 0xBF10). The device ignores the save command if any of these locations have already been written to.

ALARM INDICATOR SIGNALS

DIO_CTRL[5:2] and ALM_CTRL[6] provide controls for establishing DIO1 and DIO2 as dedicated alarm output indicator signals. Use DIO_CTRL[5:2] to select Alarm function for DIO1 and/or DIO2; then set ALM_CTRL[6] = 1 to enable DIO1 to serve as an Alarm 1 indicator and DIO2 as an Alarm 2 indicator. This setting establishes DIO1 to indicate Alarm 1 (warning) conditions and DIO2 to indicate Alarm 2 (critical) conditions.

ALARM FLAGS AND CONDITIONS

The FFT header (see Table 52) contains both generic alarm flags (DIAG_STAT[13:8] (see Table 58) and spectral band-specific alarm flags (ALM_x_STAT, see Table 33, Table 34 and Table 35). The FFT header also contains magnitude (ALM_x_PEAK, see Table 36, Table 37 and Table 38) and frequency information (ALM_x_FREQ, see Table 39, Table 40, and Table 41) associated with the highest magnitude of vibration content in the record.

ALARM STATUS

The ALM_x_STAT registers, in Table 33, Table 34, and Table 35, provide alarm bits for each spectral band on the current sample rate option.

Table 33. ALM_X_STAT Bit Assignments

Bits	Description (Default = 0x0000)
[15]	Alarm 2 on Band 6, 1 = alarm set, 0 = no alarm
[14]	Alarm 1 on Band 6, 1 = alarm set, 0 = no alarm
[13]	Alarm 2 on Band 5, 1 = alarm set, 0 = no alarm
[12]	Alarm 1 on Band 5, 1 = alarm set, 0 = no alarm
[11]	Alarm 2 on Band 4, 1 = alarm set, 0 = no alarm
[10]	Alarm 1 on Band 4, 1 = alarm set, 0 = no alarm
[9]	Alarm 2 on Band 3, 1 = alarm set, 0 = no alarm
[8]	Alarm 1 on Band 3, 1 = alarm set, 0 = no alarm
[7]	Alarm 2 on Band 2, 1 = alarm set, 0 = no alarm
[6]	Alarm 1 on Band 2, 1 = alarm set, 0 = no alarm
[5]	Alarm 2 on Band 1, 1 = alarm set, 0 = no alarm
[4]	Alarm 1 on Band 1, 1 = alarm set, 0 = no alarm
[3]	Not used
[2:0]	Most critical alarm condition, spectral band, range: 1 to 6

Table 34. ALM_Y_STAT Bit Assignments

Bits	Description (Default = 0x0000)
[15]	Alarm 2 on Band 6, 1 = alarm set, 0 = no alarm
[14]	Alarm 1 on Band 6, 1 = alarm set, 0 = no alarm
[13]	Alarm 2 on Band 5, 1 = alarm set, 0 = no alarm
[12]	Alarm 1 on Band 5, 1 = alarm set, 0 = no alarm
[11]	Alarm 2 on Band 4, 1 = alarm set, 0 = no alarm
[10]	Alarm 1 on Band 4, 1 = alarm set, 0 = no alarm
[9]	Alarm 2 on Band 3, 1 = alarm set, 0 = no alarm
[8]	Alarm 1 on Band 3, 1 = alarm set, 0 = no alarm
[7]	Alarm 2 on Band 2, 1 = alarm set, 0 = no alarm
[6]	Alarm 1 on Band 2, 1 = alarm set, 0 = no alarm
[5]	Alarm 2 on Band 1, 1 = alarm set, 0 = no alarm
[4]	Alarm 1 on Band 1, 1 = alarm set, 0 = no alarm
[3]	Not used
[2:0]	Most critical alarm condition, spectral band, range: 1 to 6

Table 35. ALM_Z_STAT Bit Assignments

Bits	Description (Default = 0x0000)
[15]	Alarm 2 on Band 6, 1 = alarm set, 0 = no alarm
[14]	Alarm 1 on Band 6, 1 = alarm set, 0 = no alarm
[13]	Alarm 2 on Band 5, 1 = alarm set, 0 = no alarm
[12]	Alarm 1 on Band 5, 1 = alarm set, 0 = no alarm
[11]	Alarm 2 on Band 4, 1 = alarm set, 0 = no alarm
[10]	Alarm 1 on Band 4, 1 = alarm set, 0 = no alarm
[9]	Alarm 2 on Band 3, 1 = alarm set, 0 = no alarm
[8]	Alarm 1 on Band 3, 1 = alarm set, 0 = no alarm
[7]	Alarm 2 on Band 2, 1 = alarm set, 0 = no alarm
[6]	Alarm 1 on Band 2, 1 = alarm set, 0 = no alarm
[5]	Alarm 2 on Band 1, 1 = alarm set, 0 = no alarm
[4]	Alarm 1 on Band 1, 1 = alarm set, 0 = no alarm
[3]	Not used
[2:0]	Most critical alarm condition, spectral band, range: 1 to 6

WORST-CONDITION MONITORING

The ALM_x_PEAK registers (see Table 36, Table 37, and Table 38) contain the peak magnitude for the worst-case alarm condition in each axis. The ALM_x_FREQ registers (see Table 39, Table 40, and Table 41) contain the frequency bin number for the worst-case alarm condition.

Table 36. ALM_X_PEAK Bit Assignments

Bits	Description (Default = 0x0000)
[15:0]	Alarm peak, x-axis, accelerometer data format

Table 37. ALM_Y_PEAK Bit Assignments

Bits	Description (Default = 0x0000)
[15:0]	Alarm peak, y-axis, accelerometer data format

Table 38. ALM_Z_PEAK Bit Assignments

Bits	Description (Default = 0x0000)
[15:0]	Alarm peak, z-axis, accelerometer data format

Table 39. ALM_X_FREQ Bit Assignments

Bits	Description (Default = 0x0000)
[15:8]	Not used
[7:0]	Alarm frequency for x-axis peak alarm level, FFT bin number, range: 0 to 255

Table 40. ALM_Y_FREQ Bit Assignments

Bits	Description (Default = 0x0000)
[15:8]	Not used
[7:0]	Alarm frequency for y-axis peak alarm level, FFT bin number, range: 0 to 255

Table 41. ALM_Z_FREQ Bit Assignments

Bits	Description (Default = 0x0000)
[15:8]	Not used
[7:0]	Alarm frequency for z-axis peak alarm level, FFT bin number, range: 0 to 255

READING OUTPUT DATA

The ADIS16227 samples, processes, and stores x, y, and z acceleration data into the FFT buffer and FFT records (if selected). In manual time mode, each axis' record contains 512 samples for each axis. Otherwise, each record contains the 256-point FFT result for each accelerometer axis. Table 42 provides a summary of registers that provide access to processed sensor data.

Table 42. Output Data Registers

Register	Address	Description
SUPPLY_OUT	0x0A	Internal power supply
TEMP_OUT	0x0C	Internal temperature
BUF_PNTR	0x10	Data buffer index pointer
REC_PNTR	0x12	FFT record index pointer
X_BUF	0x14	X-axis accelerometer buffer
Y_BUF	0x16	Y-axis accelerometer buffer
Z_BUF	0x18	Z-axis accelerometer buffer
GLOB_CMD	0x3E	FFT record retrieve command
TIME_STAMP_L	0x4C	Time stamp, lower word
TIME_STAMP_H	0x4E	Time stamp, upper word
REC_INFO	0x76	FFT record header information

READING DATA FROM THE DATA BUFFER

After completing an FFT event and updating the data buffer, the ADIS16227 loads the first data samples from the data buffer into the x_BUF registers (see Table 45) and sets the buffer index pointer (BUF_PNTR) to 0x0000. The index pointer determines which data samples load into the x_BUF registers. For example, writing 0x009F to the BUF_PNTR register (DIN = 0x9100, DIN = 0x909F) causes the 160th sample in each data buffer location to load into the x_BUF registers. The index pointer increments with every x_BUF read command, which causes the next set of capture data to load into each capture buffer register automatically. This enables a process-efficient method for reading all 256 samples in a record, using sequential reads commands, without having to manipulate BUF_PNTR.

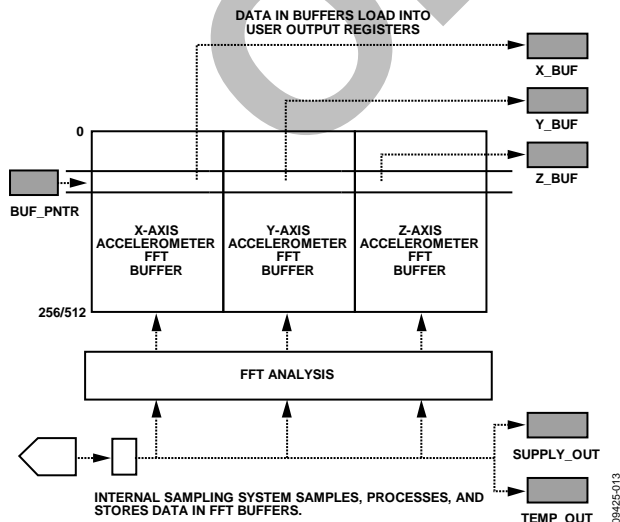

Figure 15. Data Buffer Structure and Operation

Table 43. BUF_PNTR Bit Descriptions

Bits	Description (Default = 0x0000)
[15:9]	Not used
[8:0]	Data bits

ACCESSING FFT RECORD DATA

The FFT records provide flash memory storage for FFT data. The REC_PNTR register (see Table 44) and record retrieve command in GLOB_CMD[13] (see Table 57) provide access to the FFT records, as shown in Figure 16. For example, set REC_PNTR[7:0] = 0x0A (DIN = 0x920A) and GLOB_CMD[13] = 1 (DIN = 0xBF20) to load FFT Record 10 in the FFT buffer for SPI/register access.

Table 44. REC_PNTR Bit Descriptions

Bits	Description (Default = 0x0000)
[15:4]	Not used
[3:0]	Data bits

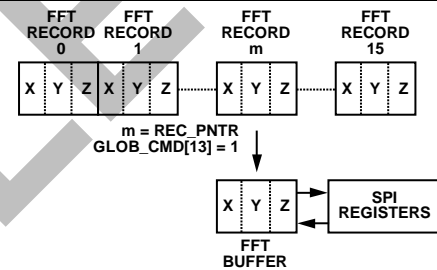

Figure 16. FFT Record Access

DATA FORMAT

Table 45 provides the bit assignments for the x_BUF registers. The acceleration data format depends on the range scale and recording mode settings in REC_CTRL. See Table 10 for configuration details and Table 17 for the scale factors associated with each setting. Table 46 provides some data formatting examples for FFT mode, and Table 47 offers some data formatting examples for the 16-bit two's complement format used in manual time mode.

Table 45. X_BUF, Y_BUF, Z_BUF Bit Descriptions

Bits	Description (Default = 0x8000)
[15:0]	Acceleration buffer registers

Table 46. FFT Mode, 0 g to 5 g Range, Data Format Examples

Acceleration (mg)	LSB	Hex	Binary
4999.9237	65,535	0xFFFF	1111 1111 1111 1111
7.63	100	0x0064	0000 0000 0110 0100
0.1526	2	0x0002	0000 0000 0000 0010
0.0763	1	0x0001	0000 0000 0000 0001
0	0	0x0000	0000 0000 0000 0000

Table 47. Acceleration Format, Time Domain, 0 g to 70 g Range

Acceleration (mg)	LSB	Hex	Binary
+70,000	+29,360	0x72B0	0111 0010 1011 0000
+1001.358	+420	0x01A4	0000 0001 1010 0100
+4.7684	+2	0x0002	0000 0000 0000 0010
+2.3842	+1	0x0001	0000 0000 0000 0001
0	0	0x0000	0000 0000 0000 0000
-2.3842	-1	0xFFFF	1111 1111 1111 1111
-4.7684	-2	0xFFFE	1111 1111 1111 1110
-1001.358	-420	0xFE5C	1111 1110 0101 1100
-70,000	-29,360	0x8D50	1000 1101 0101 0000

POWER SUPPLY/TEMPERATURE

During every acceleration recording process, the ADIS16227 also measures power supply and internal temperature. It takes a 5.12 ms record of power supply measurements at a sample rate of 50 kHz and takes 64 samples of internal temperature data over a period of 1.7 ms. The average of the power supply and internal temperature loads into the SUPPLY_OUT and TEMP_OUT registers, respectively.

Table 48. SUPPLY_OUT Bits Descriptions

Bits	Description (Default = 0x8000)
[15:12]	Not used
[11:0]	Power supply, binary, +3.3 V = 0xA8F, 1.22 mV/LSB

Table 49. Power Supply Data Format Examples

Supply Level (V)	LSB	Hex	Binary
3.6	2949	0xB85	1011 1000 0101
3.3 + 0.0012207	2704	0xA90	1010 1001 0000
3.3	2703	0xA8F	1010 1000 1111
3.3 - 0.0012207	2702	0xA8E	1010 1000 1110
3.15	2580	0xA14	1010 0001 0100

Table 50. TEMP_OUT Bit Descriptions

Bits	Description (Default = 0x8000)
[15:12]	Not used
[11:0]	Temperature data, offset binary, 1278 LSB = +25°C, -0.47°C/LSB

Table 51. Internal Temperature Data Format Examples

Temperature (°C)	LSB	Hex	Binary
125	1065	0x429	0100 0010 1001
25 + 0.47	1277	0x4FD	0100 1111 1101
25	1278	0x4FE	0100 1111 1110
25 - 0.047	1279	0x4FF	0100 1111 1111
0	1331	0x533	0101 0011 0011
-40	1416	0x588	0101 1000 1000

FFT EVENT HEADER

Each FFT record has an FFT header, which contains information that fills all of the registers listed in Table 52. The information in these registers contains recording time, record configuration settings, status/error flags, and several alarm outputs. The registers listed in Table 52 update with every record event and also update with record-specific information when using GLOB_CMD[13] to retrieve a data set from the FFT record.

Table 52. FFT Header Register Information

Register	Address	Description
DIAG_STAT	0x3C	Alarm status
ALM_X_STAT	0x40	X-alarm status
ALM_Y_STAT	0x42	Y-alarm status
ALM_Z_STAT	0x44	Z-alarm status
ALM_X_PEAK	0x46	X-alarm peak
ALM_Y_PEAK	0x48	Y-alarm peak
ALM_Z_PEAK	0x4A	Z-alarm peak
TIME_STAMP_L	0x4C	Time stamp, lower word
TIME_STAMP_H	0x4E	Time stamp, upper word
ALM_X_FREQ	0x70	X-alarm frequency of peak alarm
ALM_Y_FREQ	0x72	Y-alarm frequency of peak alarm
ALM_Z_FREQ	0x74	Z-alarm frequency of peak alarm
REC_INFO	0x76	FFT record header information

The REC_INFO register (see Table 53) captures the settings associated with the current FFT record.

Table 53. REC_INFO Bit Descriptions

Bits	Description (Default = 0x0000)
[15:14]	Sample rate setting: 00 = SR0, 01 = SR1, 10 = SR2, 11 = SR3
[13:12]	Window setting: 00 = rectangular, 01 = Hanning, 10 = flat top, 11 = N/A
[11:10]	Signal range: 00 = 0 g to 1 g, 01 = 0 g to 5 g, 10 = 0 g to 20 g, 11 = 0 g to 70 g
[9]	Not used
[8:0]	FFT averages, range: 1 to 256

The TIME_STAMP_x registers (see Table 54 and Table 55) provide a relative time stamp, which identifies the time for the current FFT record.

Table 54. TIME_STMP_L Bit Descriptions

Bits	Description (Default = 0x0000)
[15:0]	Time stamp, low integer, binary, seconds

Table 55. TIME_STMP_H Bit Descriptions

Bits	Description (Default = 0x0000)
[15:0]	Time stamp, high integer, binary, seconds

SYSTEM TOOLS

Table 56 provides an overview of the control registers that provide support for system level functions.

Table 56. System Tool Register Addresses

Register Name	Address	Description
FLASH_CNT	0x00	Flash write cycle count
DIO_CTRL	0x36	Digital I/O configuration
GPIO_CTRL	0x38	General-purpose I/O control
DIAG_STAT	0x3C	Status, error flags
GLOB_CMD	0x3E	Global commands
LOT_ID1	0x52	Lot Identification Code 1
LOT_ID2	0x54	Lot Identification Code 2
PROD_ID	0x56	Product identification
SERIAL_NUM	0x58	Serial number

GLOBAL COMMANDS

The GLOB_CMD register provides an array of single-write commands for convenience. Setting the assigned bit (see Table 57) to 1 activates each function. When the function completes, the bit restores itself to 0. For example, clear the capture buffers by setting GLOB_CMD[8] = 1 (DIN = 0xBF01). All of the commands in the GLOB_CMD register require the power supply be within normal limits for the execution times listed in Table 57.

Table 57. GLOB_CMD Bit Descriptions

Bits	Description	Execution Time
[15]	Clear x_NULL registers	35 μ s
[14]	Retrieve spectral alarm band information from the ALM_PNTR setting	40 μ s
[13]	Restore record data from flash memory	1.9 ms
[12]	Save spectral alarm band registers to flash memory	461 μ s
[11]	Record start/stop	N/A
[10]	Set BUF_PNTR = 0x0000	36 μ s
[9]	Clear spectral alarm band registers from flash	25.8 ms
[8]	Clear records	25.9 ms
[7]	Software reset	53.3 ms
[6]	Save registers to flash memory	29.3 ms
[5]	Flash test, compare sum of flash memory with factory value	5.6 ms
[4]	Clear DIAG_STAT register	36 μ s
[3]	Restore factory register settings and clear the capture buffers	80.9 ms
[2]	Self-test, result in DIAG_STAT[5]	32.9 ms
[1]	Power-down	N/A
[0]	Autonull	681 ms

STATUS/ERROR FLAGS

The DIAG_STAT register (see Table 58) provides a number of status/error flags that reflect the conditions observed in a recording during SPI communication and diagnostic tests. A 1 indicates an error condition, and all of the error flags are sticky, which means that they remain until they are reset by setting GLOB_CMD[4] = 1 (DIN = 0xBE10) or by starting a new recording event. DIAG_STAT[14:8] indicates which ALM_x_MAGx thresholds were exceeded during a recording event. The flag in DIAG_STAT[3] indicates that the total number of SCLK clocks is not a multiple of 16.

Table 58. DIAG_STAT Bit Descriptions

Bits	Description (Default = 0x0000)
[15]	Not used
[14]	System alarm flag
[13]	Z-axis, Spectral Alarm 2 flag
[12]	Y-axis, Spectral Alarm 2 flag
[11]	X-axis, Spectral Alarm 2 flag
[10]	Z-axis, Spectral Alarm 1 flag
[9]	Y-axis, Spectral Alarm 1 flag
[8]	X-axis, Spectral Alarm 1 flag
[7]	Data ready/busy indicator (0 = busy, 1 = data ready)
[6]	Flash test result, checksum flag
[5]	Self-test diagnostic error flag
[4]	Recording escape flag, indicates use of the SPI-driven interruption command, 0xE8
[3]	SPI communication failure, (SCLKs \neq even multiple of 16)
[2]	Flash update failure
[1]	Power supply above 3.625 V
[0]	Power supply below 3.125 V

OPERATION MANAGEMENT

The ADIS16227 SPI port supports two different communication commands while it is processing data or executing a command associated with the GLOB_CMD register: reading DIAG_STAT (DIN = 0x3C00) and the escape code (DIN = 0xE8E8). The SPI ignores all other commands when the processor is busy.

Software Busy Indicator

Use the DIAG_STAT read command to poll DIAG_STAT[7], which is equal to 0 when the processor is busy and equal to 1 when the processor is idle and data is ready for SPI communications.

Software Escape Code

The only SPI command available when the processor is busy is the escape code, which is 0xE8E8. Send this command in a repeating pattern, with a small delay between each write cycle, to the DIN pin, while monitoring DIAG_STAT[7]. The following code example illustrates this process:

```
DIAG_STAT = 0;
DIAG_STAT = read_reg(0x3C);
while ((DIAG_STAT & 0x0080) == 0)
{
    write_reg(0xE8E8);
    delay_us(50);
    DIAG_STAT = read_reg(0x3C);
}
```

INPUT/OUTPUT FUNCTIONS

The DIO_CTRL register (see Table 59) provides configuration control options for the two digital I/O lines, DIO1 and DIO2.

Busy Indicator

The busy indicator is an output signal that indicates internal processor activity. This signal is active during data recording events or internal processing (GLOB_CMD functions, for example). The factory default setting for DIO_CTRL sets DIO1 as a positive, active high, busy indicator signal. When configured in this manner, use this signal to alert the master processor to read data from data buffers.

Trigger Input

The trigger function provides an input pin for starting record events with a signal pulse. Set DIO_CTRL[7:0] = 0x2F (DIN = 0xB62F) to configure DIO2 as a positive trigger input and keep DIO1 as a busy indicator. To start a trigger, the trigger input signal must transition from low to high and then from high to low. The recording process starts on the high-to-low transition, as shown in Figure 17, and the pulse duration must be at least 2.6 μs.

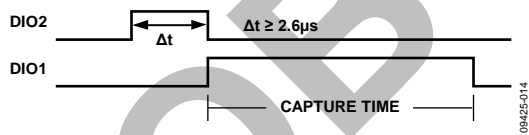

Figure 17. Manual Trigger/Busy Indicator Sequence Example

Alarm Indicator

DIO_CTRL[5:2] provide controls for establishing DIO1 and/or DIO2 as a general alarm output indicator, which goes active when any of the flags in DIAG_STAT[13:8] are active. For example, set DIO_CTRL[7:0] = 0x12 (DIN = 0xB612) to configure DIO2 as a generic alarm indicator with an active high polarity. ALM_CTRL[6] (see Table 22) provides an additional control, which enables DIO2 to reflect Alarm 2 and DIO1 to reflect Alarm 1 when they are selected as alarm indicators in DIO_CTRL[5:2]. For example, set DIO_CTRL[7:0] = 0x17 (DIN = 0xB617) and set ALM_CTRL[6] = 1 (DIN = 0xB440) to establish DIO2 as an active-high Alarm 2 indicator and DIO1 as an active-high Alarm 1 indicator. Set GLOB_CMD[4] = 1 (DIN = 0xBE10) to clear the DIAG_STAT error flags and restore the alarm indicator signal to its inactive state.

Table 59. DIO_CTRL Bit Descriptions

Bits	Description (Default = 0x000F)
[15:6]	Not used
[5:4]	DIO2 function selection 00 = general-purpose I/O (use GPIO_CTRL) 01 = alarm indicator output (per ALM_CTRL) 10 = trigger input 11 = busy indicator output
[3:2]	DIO1 function selection 00 = general-purpose I/O (use GPIO_CTRL) 01 = alarm indicator output (per ALM_CTRL) 10 = trigger input 11 = busy indicator output
[1]	DIO2 line polarity 1 = active high 0 = active low
[0]	DIO1 line polarity 1 = active high 0 = active low

General-Purpose I/O

If DIO_CTRL configures either DIO1 or DIO2 as a general-purpose digital line, use the GPIO_CTRL register in Table 60 to configure its input/output direction, set the output level when configured as an output, and monitor the status of an input.

Table 60. GPIO_CTRL Bit Descriptions

Bits	Description (Default = 0x0000)
[15:10]	Not used
[9]	DIO2 output level 1 = high 0 = low
[8]	DIO1 output level 1 = high 0 = low
[7:2]	Reserved
[1]	DIO2 direction control 1 = output 0 = input
[0]	DIO1 direction control 1 = output 0 = input

SELF-TEST

Set GLOB_CMD[2] = 1 (DIN = 0xBE02) to run an automatic self-test routine, which reports a pass/fail result to DIAG_STAT[5].

FLASH MEMORY MANAGEMENT

Set GLOB_CMD[5] = 1 (DIN = 0xBE20) to run an internal checksum test on the flash memory, which reports a pass/fail result to DIAG_STAT[6]. The FLASH_CNT register (see Table 61) provides a running count of flash memory write cycles. This is a tool for managing the endurance of the flash memory. Figure 18 quantifies the relationship between data retention and junction temperature.

Table 61. FLASH_CNT Bit Descriptions

Bits	Description
[15:0]	Binary counter for writing to flash memory

DEVICE IDENTIFICATION

Table 62. LOT_ID1 and LOT_ID2 Bit Descriptions

Bits	Description
[15:0]	Lot identification code

Table 63. PROD_ID Bit Descriptions

Bits	Description
[15:0]	0x3F63 = 16,227

Table 64. SERIAL_NUM Bit Descriptions

Bits	Description
[15:0]	Serial number, lot specific

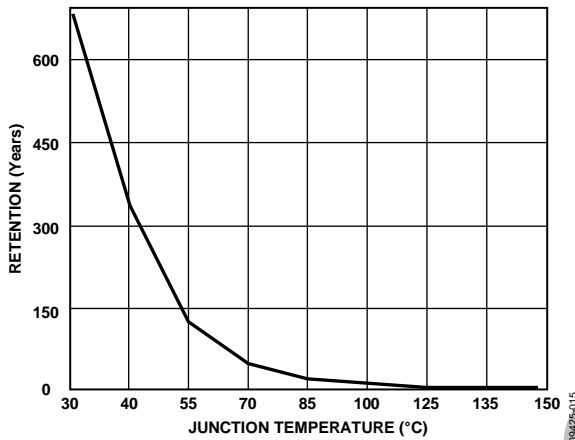

Figure 18. Flash/EE Memory Data Retention

APPLICATIONS INFORMATION

MOUNTING GUIDELINES

The ADIS16227 provides a threaded hole for a 10-32 UNF machine screw. This hole is 9 mm deep, and the tapped depth is 7 mm. Use a torque of 15 inch-pounds when tightening the 10-32 mounting fastener and make sure that the fastener doesn't bottom-out in the ADIS16227 when tightening.

GETTING STARTED

When the power supply voltage of the ADIS16227 reaches 3.15 V, it executes a start-up sequence that places the device in manual FFT mode. The following code example initiates a manual data recording by setting `GLOB_CMD[11] = 1` (`DIN = 0xBF08`) and reads all 256 samples in the x-axis acceleration buffer, using `DIN = 0x1400`. The data from the first `spi_reg_read` is not valid because this command starts the process. The second `spi_reg_read` command (the first read inside the embedded `for loop`) produces the first valid data. This code sequence produces `CS`, `SCLK`, and `DIN` signals similar to the ones shown in Figure 11.

```
spi_write(BF08h);
delay 30ms;
Data(0) = spi_reg_read(14h);
For n = 0 to 255
Data(n) = spi_reg_read(14h);
n = n + 1;
end
```

INTERFACE BOARD

The ADIS16227/PCBZ provides the ADIS16227 on a small printed circuit board (PCB) that simplifies the connection to an existing processor system. A single 10-32 machine screw (Fastener Express, FHS1106-4I2) secures the ADIS16227CMLZ to the interface board. The first set of mounting holes on the interface boards is in the four corners of the PCB and provides clearance for 4-40 machine screws. The second set of mounting holes provides a pattern that matches the ADISUSBZ evaluation system, using `M2 × 0.4 mm` machine screws. These boards are made of IS410 material and are 0.063 inches thick. The J1 connector uses Pin 1 through Pin 12 in this pattern. Pin 13 and Pin 14 are for future expansion, but they also provide convenient probe points for the

DIO1 and DIO2 signals. The connector is a dual row, 2 mm (pitch) connector that works with a number of ribbon cable systems, including 3M Part Number 152212-0100-GB (ribbon-crimp connector) and 3M Part Number 3625/12 (ribbon cable). The LEDs (D1 and D2) provide visual indication of the DIO1 and DIO2 signals.

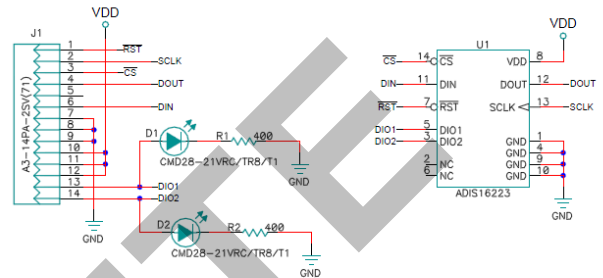

Figure 19. Electrical Schematic

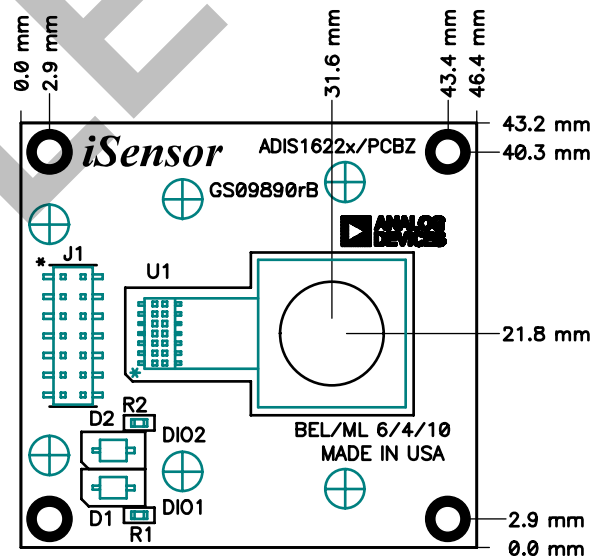

Figure 20. PCB Assembly View and Dimensions

OUTLINE DIMENSIONS

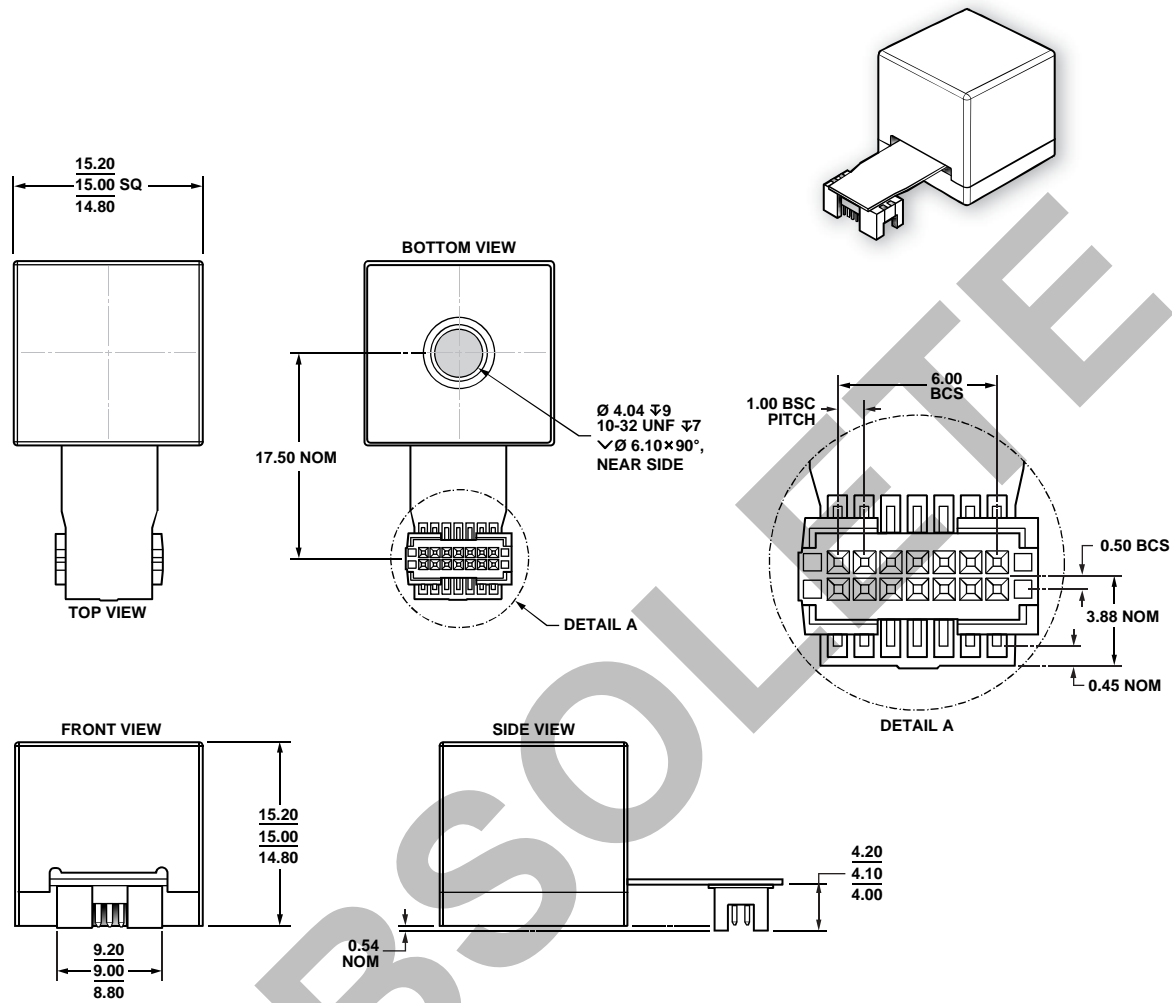

Figure 21. 14-Lead Module with Connector Interface (ML-14-2)
Dimensions shown in millimeters

ORDERING GUIDE

Model ¹	Temperature Range	Package Description	Package Option
ADIS16227CMLZ	-40°C to +125°C	14-Lead Module with Connector Interface	ML-14-2
ADIS16227/PCBZ		Evaluation Board	

¹ Z = RoHS Compliant Part.

NOTES

OBSOLETE

NOTES

OBSOLETE

X-ON Electronics

Largest Supplier of Electrical and Electronic Components

Click to view similar products for [Accelerometers](#) category:

Click to view products by [Analog Devices](#) manufacturer:

Other Similar products are found below :

[AD22372Z-RL7](#) [ADXL313WACPZ-RL](#) [805M1-0050-01](#) [MXC6655XA](#) [MMA7455LT](#) [805M1-0200-01](#) [810M1-0025X](#) [832M1-0200](#)
[AIS328DQTR](#) [832M1-0050](#) [805-0050](#) [AD22301](#) [BMA253](#) [SCA620-EF8H1A-1](#) [MC3413](#) [MXC6244AU](#) [3038-0500](#) [ACH-01-04/10](#) [4692](#)
[ADXL372BCCZ-RL7](#) [735T](#) [787-500](#) [787AM8](#) [793-6](#) [793L](#) [997-M4](#) [HV101](#) [HV102](#) [HV200](#) [PC420AR-10](#) [PC420VP-50](#) [786A](#) [786A-IS](#)
[787A](#) [787A-IS](#) [HT786A](#) [HT787A](#) [PC420VP-10](#) [AD22293Z-RL7](#) [ADIS16003CCCZ](#) [ADIS16228CMLZ](#) [ADXL700WBRWZ-RL](#)
[ADXL1003BCPZ](#) [ADXL103CE-REEL](#) [ADXL203CE-REEL](#) [ADXL206HDZ](#) [ADXL213AE](#) [ADXL288WBRDZ-RL](#) [ADXL295WBRDZ-RL](#)
[ADXL312WACPZ](#)