

FEATURES

Triaxial, digital gyroscope

$\pm 125^\circ/\text{sec}$, $\pm 500^\circ/\text{sec}$, $\pm 2000^\circ/\text{sec}$ dynamic range models

2.3°/hr in-run bias stability (ADIS16505-1)

0.13°/√hr angular random walk, x-axis and y-axis, 1 σ (ADIS16505-1)

$\pm 0.25^\circ$ axis to axis misalignment error

Triaxial, digital accelerometer, $\pm 78.4 \text{ m/sec}^2$ dynamic range

26.5 $\mu\text{m/sec}^2$ in-run bias stability (x-axis and y-axis)

Triaxial, delta angle and delta velocity outputs

Factory calibrated sensitivity, bias, and axial alignment

Calibration temperature range: -40°C to $+85^\circ\text{C}$

SPI compatible data communications

Programmable operation and control

Automatic and manual bias correction controls

Data ready indicator for synchronous data acquisition

External sync modes: direct, scaled, and output

On demand self-test of inertial sensors

On demand self-test of flash memory

Single-supply operation (VDD): 3.0 V to 3.6 V

14,700 m/sec^2 mechanical shock survivability

Operating temperature range: -40°C to $+105^\circ\text{C}$

APPLICATIONS

Navigation, stabilization, and instrumentation

Unmanned and autonomous vehicles

Smart agriculture and construction machinery

Factory/industrial automation, robotics

Virtual/augmented reality

Internet of Moving Things

GENERAL DESCRIPTION

The ADIS16505 is a precision, miniature microelectromechanical system (MEMS) inertial measurement unit (IMU) that includes a triaxial gyroscope and a triaxial accelerometer. Each inertial sensor in the ADIS16505 combines with signal conditioning that optimizes dynamic performance. The factory calibration characterizes each sensor for sensitivity, bias, alignment, linear acceleration (gyroscope bias), and point of percussion (accelerometer location). As a result, each sensor has dynamic compensation formulas that provide accurate sensor measurements over a broad set of conditions.

The ADIS16505 provides a simplified, cost effective method for integrating accurate, multi-axis inertial sensing into industrial systems, especially when compared with the complexity and investment associated with discrete designs. All necessary motion testing and calibration are part of the production process at the factory, greatly reducing system integration time. Tight orthogonal alignment simplifies inertial frame alignment in navigation systems. The serial peripheral interface (SPI) and register structure provide a simple interface for data collection and configuration control.

The ADIS16505 is available in a 100-ball, ball grid array (BGA) package that is approximately 15 mm \times 15 mm \times 5 mm.

FUNCTIONAL BLOCK DIAGRAM

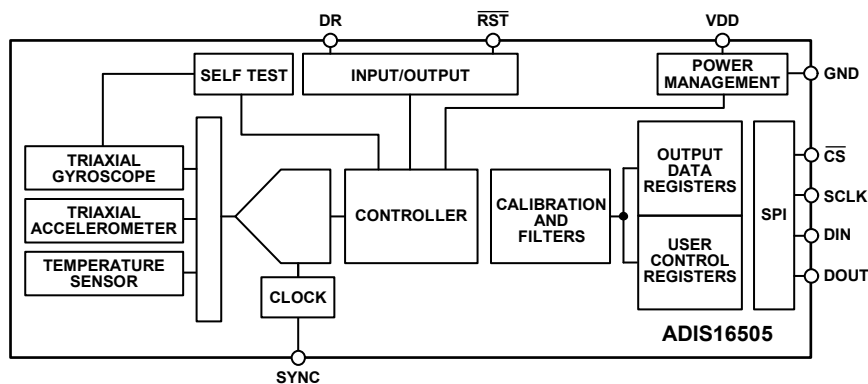

Figure 1.

Rev. C

[Document Feedback](#)

Information furnished by Analog Devices is believed to be accurate and reliable. However, no responsibility is assumed by Analog Devices for its use, nor for any infringements of patents or other rights of third parties that may result from its use. Specifications subject to change without notice. No license is granted by implication or otherwise under any patent or patent rights of Analog Devices. Trademarks and registered trademarks are the property of their respective owners.

One Technology Way, P.O. Box 9106, Norwood, MA 02062-9106, U.S.A.
Tel: 781.329.4700 ©2019–2020 Analog Devices, Inc. All rights reserved.
[Technical Support](#) www.analog.com

TABLE OF CONTENTS

Features	1	SPI	17
Applications	1	Data Ready (DR)	17
General Description	1	Reading Sensor Data	18
Functional Block Diagram	1	Burst Read Function	19
Revision History	2	Latency	21
Specifications	3	Device Configuration	21
Timing Specifications	6	Memory Structure	21
Absolute Maximum Ratings	7	User Register Memory Map	22
Thermal Resistance	7	User Register Defintions	24
ESD Caution	7	Gyroscope Data	24
Pin Configuration and Function Descriptions	8	Delta Angles	28
Typical Performance Characteristics	11	Delta Velocity	29
Gyroscopes	11	Calibration	31
Accelerometers	14	Applications Information	38
Theory of Operation	15	Assembly and Handling Tips	38
Introduction	15	Power Supply Considerations	39
Clock Control	15	Evaluation Tools	39
Bartlett Window Filter	16	Packaging and Ordering Information	41
Calibration	16	Outline Dimensions	41
Decimation Filter	16	Ordering Guide	41
Register Structure	16		

REVISION HISTORY

10/2020—Rev. B to Rev. C	
Change to Linear Acceleration Effect Parameter, Table 1	3
Changes to Figure 29	15
Changes to SPI Section and Figure 34	17
Changes to Burst Read Function	19
Changes to Table 27	26
Changes to Figure 64 and Figure 65	40
Changes to Ordering Guide	41
7/2020—Rev. A to Rev. B	
Changes to Table 1	3
Changes to Table 3 and Table 4	7
Changes to Clock Control Section	15
Changes to Figure 44 and Figure 45	20
Changes to Table 9	23
Changes to Table 11	24
Changes to Table 102 and Table 106	33
Changes to Table 108 and Table 110	34
Deleted Table 111 and Table 112; Renumbered Sequentially	34
Deleted Bias Correction Update Section	35
Changes to Table 113, Table 115, Table 117, Table 119, and Table 121	36
Changes to Table 129 and Table 131	37
Changes to Figure 65	40
10/2019—Revision A: Initial Version	

SPECIFICATIONS

Case temperature (T_c) = 25°C, VDD = 3.3 V, angular rate = 0°/sec, and dynamic range = $\pm 2000^\circ/\text{sec} \pm 1\text{ g}$, unless otherwise noted. 1 g is the acceleration due to gravity and assumed to be 9.8 m/sec².

Table 1.

Parameter	Test Conditions/Comments	Min	Typ	Max	Unit
GYROSCOPES					
Dynamic Range	ADIS16505-1	± 125			°/sec
	ADIS16505-2	± 500			°/sec
	ADIS16505-3	± 2000			°/sec
Sensitivity	ADIS16505-1, 16-bit data format		160		LSB/°/sec
	ADIS16505-2, 16-bit data format		40		LSB/°/sec
	ADIS16505-3, 16-bit data format		10		LSB/°/sec
	ADIS16505-1, 32-bit data format		10,485,760		LSB/°/sec
	ADIS16505-2, 32-bit data format		2,621,440		LSB/°/sec
	ADIS16505-3, 32-bit data format		655,360		LSB/°/sec
Error over Temperature	ADIS16505-1, $-40^\circ\text{C} \leq T_c \leq +85^\circ\text{C}$, 1 σ		± 0.5		%
	ADIS16505-2, $-40^\circ\text{C} \leq T_c \leq +85^\circ\text{C}$, 1 σ		± 0.5		%
	ADIS16505-3, $-40^\circ\text{C} \leq T_c \leq +85^\circ\text{C}$, 1 σ		± 0.3		%
Misalignment Error ¹	Axis to axis, $-40^\circ\text{C} \leq T_c \leq +85^\circ\text{C}$, 1 σ		± 0.25		Degrees
Nonlinearity ²	ADIS16505-1, full scale (FS) = 125°/sec		0.2		%FS
	ADIS16505-2, FS = 500°/sec		0.2		%FS
	ADIS16505-3, FS = 2000°/sec		0.2		%FS
Bias					
Repeatability ³	$-40^\circ\text{C} \leq T_c \leq +85^\circ\text{C}$, 1 σ , x-axis and z-axis		0.14		°/sec
	$-40^\circ\text{C} \leq T_c \leq +85^\circ\text{C}$, 1 σ , y-axis		1.4		°/sec
In-Run Bias Stability	ADIS16505-1, 1 σ , x-axis		1.5		°/hr
	ADIS16505-1, 1 σ , y-axis		2.3		°/hr
	ADIS16505-1, 1 σ , z-axis		1.7		°/hr
	ADIS16505-2, 1 σ , x-axis		2.2		°/hr
	ADIS16505-2, 1 σ , y-axis		2.7		°/hr
	ADIS16505-2, 1 σ , z-axis		1.6		°/hr
	ADIS16505-3, 1 σ , x-axis		7.5		°/hr
	ADIS16505-3, 1 σ , y-axis		8.1		°/hr
	ADIS16505-3, 1 σ , z-axis		4.9		°/hr
Angular Random Walk	ADIS16505-1, x-axis and y-axis, 1 σ		0.13		°/√hr
	ADIS16505-1, z-axis, 1 σ		0.19		°/√hr
	ADIS16505-2, x-axis and y-axis, 1 σ		0.15		°/√hr
	ADIS16505-2, z-axis, 1 σ		0.2		°/√hr
	ADIS16505-3, x-axis and y-axis, 1 σ		0.29		°/√hr
	ADIS16505-3, z-axis, 1 σ		0.32		°/√hr
Error over Temperature	$-40^\circ\text{C} \leq T_c \leq +85^\circ\text{C}$, 1 σ , x-axis and z-axis		± 0.3		°/sec
	$-40^\circ\text{C} \leq T_c \leq +85^\circ\text{C}$, 1 σ , y-axis		± 0.7		°/sec
Linear Acceleration Effect	X-axis, 1 σ		0.572×10^{-3}		(°/sec)/(m/sec ²)
	Y-axis, 1 σ		1.02×10^{-3}		(°/sec)/(m/sec ²)
	Z-axis, 1 σ		0.045×10^{-3}		(°/sec)/(m/sec ²)
Vibration Rectified Error (VRE)	X-axis, random vibration, 19.6 m/sec ² rms, 50 Hz to 2 kHz		3.1×10^{-6}		(°/sec)/(m/sec ²) ²
	Y-axis, random vibration, 19.6 m/sec ² rms, 50 Hz to 2 kHz		5.6×10^{-6}		(°/sec)/(m/sec ²) ²
	Z-axis, random vibration, 19.6 m/sec ² rms, 50 Hz to 2 kHz		0.3×10^{-6}		(°/sec)/(m/sec ²) ²

Parameter	Test Conditions/Comments	Min	Typ	Max	Unit
Output Noise	No filtering, 1 σ , 25°C				
	ADIS16505-1, x-axis, y-axis		68×10^{-3}		°/sec rms
	ADIS16505-1, z-axis		104×10^{-3}		°/sec rms
	ADIS16505-2, x-axis, y-axis		82×10^{-3}		°/sec rms
	ADIS16505-2, z-axis		116×10^{-3}		°/sec rms
	ADIS16505-3, all axes		152×10^{-3}		°/sec rms
Rate Noise Density	Frequency = 10 Hz to 40 Hz		181×10^{-3}		
	ADIS16505-1, x-axis and y-axis				°/sec/ $\sqrt{\text{Hz}}$ rms
	ADIS16505-1, z-axis		3.0×10^{-3}		°/sec/ $\sqrt{\text{Hz}}$ rms
	ADIS16505-2, x-axis and y-axis		4.3×10^{-3}		°/sec/ $\sqrt{\text{Hz}}$ rms
	ADIS16505-2, z-axis		3.4×10^{-3}		°/sec/ $\sqrt{\text{Hz}}$ rms
	ADIS16505-3, x-axis and y-axis		4.6×10^{-3}		°/sec/ $\sqrt{\text{Hz}}$ rms
3 dB Bandwidth	ADIS16505-3, z axis		6.1×10^{-3}		°/sec/ $\sqrt{\text{Hz}}$ rms
	ADIS16505-1, ADIS16505-2, x-axis and y-axis		480		Hz
	ADIS16505-1, ADIS16505-2, z-axis		590		Hz
	ADIS16505-3, x-axis and y-axis		573		Hz
Sensor Resonant Frequency	ADIS16505-3, z-axis		639		Hz
	X-axis, y-axis		66		kHz
	Z-axis		78		kHz
ACCELEROMETERS ⁴	Each axis				
Dynamic Range		± 78.4			m/sec ²
Sensitivity	32-bit data format		26,756,268		LSB/(m/sec ²)
Error over Temperature	-40°C \leq T _c \leq +85°C, 1 σ		± 0.07		%
Repeatability ³	-40°C \leq T _c \leq +85°C, 1 σ		± 0.1		%
Misalignment Error	Axis to axis, -40°C \leq T _c \leq +85°C, 1 σ		± 0.05		Degrees
Nonlinearity	Best fit straight line, ± 19.6 m/sec ²		0.25		%FS
	Best fit straight line, ± 78.4 m/sec ² , x-axis		0.5		%FS
	Best fit straight line, ± 78.4 m/sec ² , y-axis and z-axis		1.5		%FS
Bias					
Repeatability ³	-40°C \leq T _c \leq +85°C, 1 σ		19.6×10^{-3}		m/sec ²
In-Run Bias Stability	1 σ				
	X-Axis and Y-Axis		26.5×10^{-6}		m/sec ²
	Z-Axis		43.1×10^{-6}		m/sec ²
Velocity Random Walk	1 σ				
	X-Axis and Y-Axis		0.009		m/sec/ $\sqrt{\text{hr}}$
	Z-Axis		0.012		m/sec/ $\sqrt{\text{hr}}$
Error over Temperature	-40°C \leq T _c \leq +85°C, 1 σ		$\pm 9.8 \times 10^{-3}$		m/sec ²
Output Noise	No filtering				
	X-Axis and Y-Axis		4.8×10^{-3}		m/sec ² rms
	Z-Axis		6.07×10^{-3}		m/sec ² rms
Noise Density	f = 10 Hz to 40 Hz, no filtering				
	X-Axis and Y-Axis		167×10^{-6}		m/sec ² / $\sqrt{\text{Hz}}$ rms
	Z-Axis		243×10^{-6}		m/sec ² / $\sqrt{\text{Hz}}$ rms
3 dB Bandwidth			750		Hz
Sensor Resonant Frequency	X-axis and y-axis		2.4		kHz
	Z-axis		2.2		kHz
TEMPERATURE SENSOR					
Scale Factor	Output = 0x0000 at 0°C ($\pm 5^\circ\text{C}$)		0.1		°C/LSB

Parameter	Test Conditions/Comments	Min	Typ	Max	Unit
LOGIC INPUTS ⁵					
Input Voltage					
High, V_{IH}		2.0			V
Low, V_{IL}				0.8	V
\overline{RST} Pulse Width		1			μ s
Input Current					
Logic 1, I_{IH}	$V_{IH} = 3.3$ V			10	μ A
Logic 0, I_{IL}	$V_{IL} = 0$ V			10	μ A
All Pins Except \overline{RST}				10	μ A
\overline{RST} Pin			0.33		mA
Input Capacitance, C_{IN}			10		pF
DIGITAL OUTPUTS					
Output Voltage					
High, V_{OH}	Source current (I_{SOURCE}) = 0.5 mA	2.4			V
Low, V_{OL}	Sink current (I_{SINK}) = 2.0 mA			0.4	V
FLASH MEMORY					
Data Retention ⁷	Endurance ⁶ $T_J = 85^\circ\text{C}$	10,000 20			Cycles Years
FUNCTIONAL TIMES ⁸	Time until data is available				
Power-On Start-Up Time			310		ms
Reset Recovery Time ⁹	GLOB_CMD, Bit 7 = 1 (see Table 112)		255		ms
Factory Calibration Restore	GLOB_CMD, Bit 1 = 1 (see Table 112)		136		ms
Flash Memory Backup	GLOB_CMD, Bit 3 = 1 (see Table 112)		70		ms
Flash Memory Test Time	GLOB_CMD, Bit 4 = 1 (see Table 112)		30		ms
Self Test Time ¹⁰	GLOB_CMD, Bit 2 = 1 (see Table 112)		24		ms
CONVERSION RATE					
Initial Clock Accuracy			2000 3		SPS %
Sync Input Clock		1.9		2.1	kHz
POWER SUPPLY, VDD	Operating voltage range	3.0		3.6	V
Power Supply Current ¹¹	Normal mode, VDD = 3.3 V		44	55	mA

¹ Cross-axis sensitivity is the sine of this number.

² This measurement is based on the deviation from a best fit linear model.

³ Bias repeatability provides an estimate for long-term drift in the bias, as observed during 500 hours of high temperature operating life (HTOL) at 105°C.

⁴ All specifications associated with the accelerometers relate to the full-scale range of ± 8 g, unless otherwise noted.

⁵ The digital input/output signals use a 3.3 V system.

⁶ Endurance is qualified as per JEDEC Standard 22, Method A117, measured at -40°C , $+25^\circ\text{C}$, $+85^\circ\text{C}$, and $+125^\circ\text{C}$.

⁷ The data retention specification assumes a junction temperature (T_J) of 85°C per JEDEC Standard 22, Method A117. Data retention lifetime decreases with T_J .

⁸ These times do not include thermal settling and internal filter response times, which may affect overall accuracy.

⁹ The \overline{RST} line must be in a low state for at least 10 μ s to ensure a proper reset initiation and recovery.

¹⁰ The self test time can extend when using external clock rates lower than 2000 Hz.

¹¹ Power supply current transients can reach 100 mA during initial startup or reset recovery.

TIMING SPECIFICATIONS

T_A = 25°C, VDD = 3.3 V, unless otherwise noted.

Table 2.

Parameter	Description	Normal Mode			Burst Read Mode			Unit
		Min	Typ	Max	Min	Typ	Max	
f _{SCLK}	Serial clock	0.1		2.1	0.1		1.1	MHz
t _{STALL}	Stall period between data	16			N/A ¹			μs
t _{READRATE}	Read rate	24						μs
t _{CS}	Chip select to SCLK edge	200			200			ns
t _{DAV}	DOUT valid after SCLK edge			25			25	ns
t _{DSU}	DIN setup time before SCLK rising edge	25			25			ns
t _{DHD}	DIN hold time after SCLK rising edge	50			50			ns
t _{SCLKR} , t _{SCLKF}	SCLK rise/fall times		5	12.5		5	12.5	ns
t _{DR} , t _{DF}	DOUT rise/fall times		5	12.5		5	12.5	ns
t _{SFS}	CS high after SCLK edge	0			0			ns
t ₁	Input sync positive pulse width; direct sync mode, MSC_CTRL[3:2] = 01 (binary, see Table 106)	5			5			μs
t _{STDR}	Input sync to data ready valid transition, no SPI traffic, direct sync mode, MSC_CTRL[3:2] = 01 (binary, see Table 106)		305			305		μs
	Input sync to data ready valid transition, full SPI traffic ² , direct sync mode, MSC_CTRL[3:2] = 01 (binary, see Table 106)		405			405		μs
t _{NV}	Data invalid time		23			23		μs
t ₂	Input sync period	500			500			μs

¹ N/A means not applicable.

² Full SPI traffic is defined as a transfer of 64 16-bit registers using an SCLK frequency of 2 MHz. Reading the sensor values from the previous data sample proportionally increases the t_{STDR} on the current cycle.

Timing Diagrams

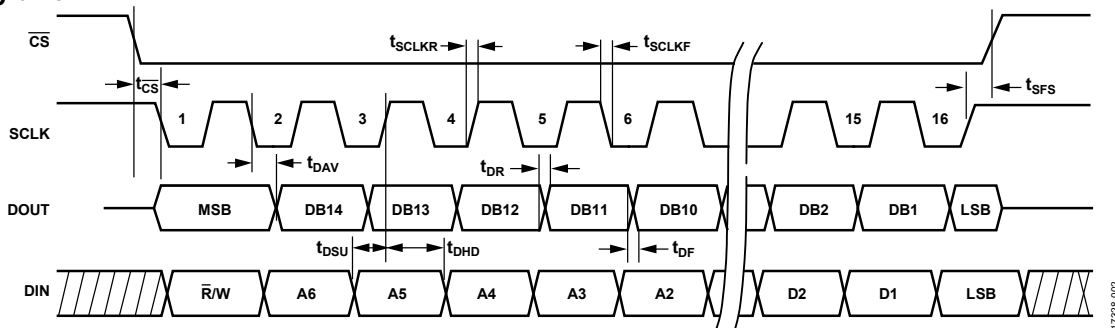

Figure 2. SPI Timing and Sequence Diagram

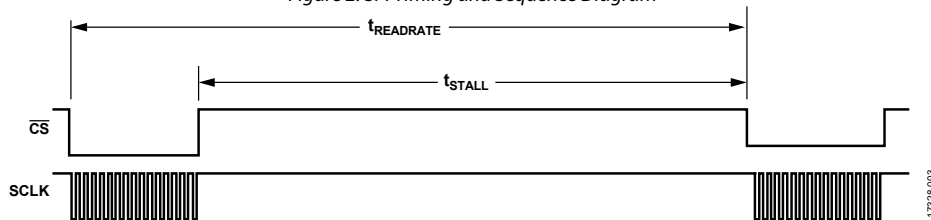

Figure 3. Stall Time and Data Rate Timing Diagram

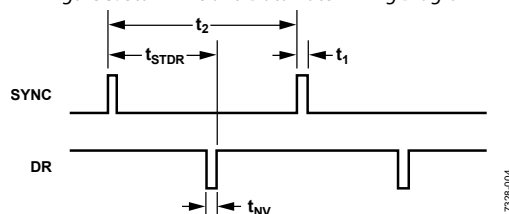

Figure 4. Input Clock Timing Diagram, Direct Sync Mode, Register MSC_CTRL[3:2] = 01 (Binary)

ABSOLUTE MAXIMUM RATINGS**Table 3.**

Parameter	Rating
Mechanical Shock Survivability Any Axis, Unpowered, 0.5 ms , ½ Sine.	14,700 m/sec ²
VDD to GND	–0.3 V to +3.6 V
Digital Input Voltage to GND	–0.3 V to VDD + 0.2 V
Digital Output Voltage to GND	–0.3 V to VDD + 0.2 V
Temperature Range	
Calibration	–40°C to +85°C
Operating	–40°C to +105°C
Storage ¹	–65°C to +150°C
Barometric Pressure	2 bar

¹ Extended exposure to temperatures that are lower than –40°C or higher than +105°C can adversely affect the accuracy of the factory calibration.

Stresses at or above those listed under Absolute Maximum Ratings may cause permanent damage to the product. This is a stress rating only; functional operation of the product at these or any other conditions above those indicated in the operational section of this specification is not implied. Operation beyond the maximum operating conditions for extended periods may affect product reliability.

THERMAL RESISTANCE

Thermal performance is directly linked to printed circuit board (PCB) design and operating environment. Careful attention to PCB thermal design is required.

The ADIS16505 is a multichip module that includes many active components. The values in Table 4 identify the thermal response of the hottest component inside of the ADIS16505, with respect to the overall power dissipation of the module. This approach enables a simple method for predicting the temperature of the hottest junction, based on either ambient or case temperature.

For example, when the ambient temperature is 70°C, the hottest junction temperature (T_J) inside of the ADIS16505 is 76.7°C.

$$T_J = \theta_{JA} \times VDD \times I_{DD} + 70^\circ\text{C}$$

$$T_J = 107.1^\circ\text{C/W} \times 3.3 \text{ V} \times 0.044 \text{ A} + 70^\circ\text{C}$$

$$T_J = 85.6^\circ\text{C}$$

Table 4. Package Characteristics

Package Type	θ_{JA} ¹	θ_{JC} ²	Device Weight
ML-100-1 ³	107.1°C/W	74.7°C/W	<1.75 g

¹ θ_{JA} is the natural convection junction to ambient thermal resistance measured in a one cubic foot sealed enclosure.

² θ_{JC} is the junction to case thermal resistance.

³ Thermal impedance values come from direct observation of the hottest temperature inside of the ADIS16505 when it is attached to an FR4-08 PCB that has two metal layers and has a thickness of 0.063 inches.

ESD CAUTION

ESD (electrostatic discharge) sensitive device. Charged devices and circuit boards can discharge without detection. Although this product features patented or proprietary protection circuitry, damage may occur on devices subjected to high energy ESD. Therefore, proper ESD precautions should be taken to avoid performance degradation or loss of functionality.

PIN CONFIGURATION AND FUNCTION DESCRIPTIONS

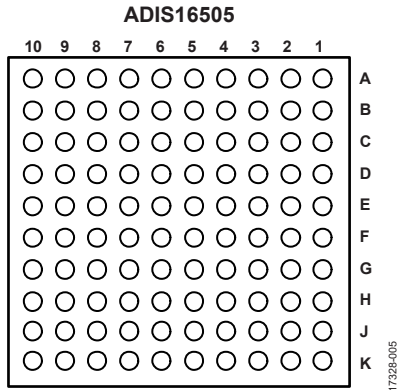

Figure 5. Pin Assignments, Bottom View

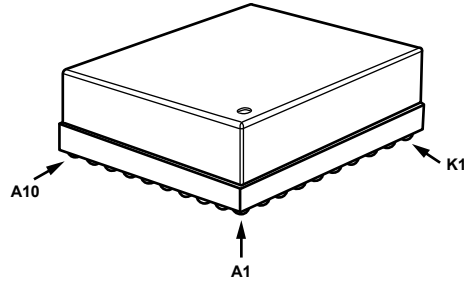

Figure 6. Pin Assignments, Package Level View

Table 5. Pin Function Descriptions

Pin No.	Mnemonic	Type	Description
A1	GND	Supply	Power Ground
A2	GND	Supply	Power Ground
A3	GND	Supply	Power Ground
A4	GND	Supply	Power Ground
A5	GND	Supply	Power Ground
A6	GND	Supply	Power Ground
A7	GND	Supply	Power Ground
A8	GND	Supply	Power Ground
A9	NC	Not applicable	No Connection
A10	NC	Not applicable	No Connection
B1	NC	Not applicable	No Connection
B2	NC	Not applicable	No Connection
B3	GND	Supply	Power Ground
B4	GND	Supply	Power Ground
B5	GND	Supply	Power Ground
B6	GND	Supply	Power Ground
B7	NC	Not applicable	No Connection
B8	NC	Not applicable	No Connection
B9	NC	Not applicable	No Connection
B10	NC	Not applicable	No Connection
C1	NC	Not applicable	No Connection
C2	GND	Supply	Power Ground
C3	DNC	Not applicable	Do Not Connect
C4	NC	Not applicable	No Connection
C5	NC	Not applicable	No Connection
C6	GND	Supply	Power Ground
C7	VDD	Supply	Power Supply
C8	NC	Not applicable	No Connection
C9	NC	Not applicable	No Connection
C10	NC	Not applicable	No Connection

Pin No.	Mnemonic	Type	Description
D1	NC	Not applicable	No Connection
D2	NC	Not applicable	No Connection
D3	GND	Supply	Power Ground
D4	NC	Not applicable	No Connection
D5	NC	Not applicable	No Connection
D6	VDD	Supply	Power Supply
D7	NC	Not applicable	No Connection
D8	NC	Not applicable	No Connection
D9	NC	Not applicable	No Connection
D10	NC	Not applicable	No Connection
E1	NC	Not applicable	No Connection
E2	GND	Supply	Power Ground
E3	VDD	Supply	Power Supply
E4	NC	Not applicable	No Connection
E5	NC	Not applicable	No Connection
E6	GND	Supply	Power Ground
E7	GND	Supply	Power Ground
E8	NC	Not applicable	No Connection
E9	NC	Not applicable	No Connection
E10	NC	Not applicable	No Connection
F1	GND	Supply	Power Ground
F2	NC	Not applicable	No Connection
F3	$\overline{\text{RST}}$	Input	Reset
F4	NC	Not applicable	No Connection
F5	GND	Supply	Power Ground
F6	GND	Supply	Power Ground
F7	NC	Not applicable	No Connection
F8	GND	Supply	Power Ground
F9	NC	Not applicable	No Connection
F10	NC	Not applicable	No Connection
G1	VDD	Supply	Power Supply
G2	GND	Supply	Power Ground
G3	$\overline{\text{CS}}$	Input	SPI, Chip Select
G4	NC	Not applicable	No Connection
G5	NC	Not applicable	No Connection
G6	DIN	Input	SPI, Data Input
G7	GND	Supply	Power Supply
G8	NC	Not applicable	No Connection
G9	NC	Not applicable	No Connection
G10	NC	Not applicable	No Connection
H1	VDD	Supply	Power Supply
H2	NC	Not applicable	No Connection
H3	DOUT	Output	SPI, Data Output
H4	NC	Not applicable	No Connection
H5	NC	Not applicable	No Connection
H6	SCLK	Input	SPI, Serial Clock
H7	NC	Not applicable	No Connection
H8	GND	Supply	Power Ground
H9	NC	Not applicable	No Connection
H10	NC	Not applicable	No Connection

Pin No.	Mnemonic	Type	Description
J1	NC	Not applicable	No Connection
J2	GND	Supply	Power Ground
J3	SYNC	Input	Sync (External Clock)
J4	VDD	Supply	Power Supply
J5	VDD	Supply	Power Supply
J6	DR	Output	Data Ready
J7	GND	Supply	Power Ground
J8	NC	Not applicable	No Connection
J9	NC	Not applicable	No Connection
J10	NC	Not applicable	No Connection
K1	GND	Supply	Power Ground
K2	NC	Not applicable	No Connection
K3	GND	Supply	Power Ground
K4	NC	Not applicable	No Connection
K5	NC	Not applicable	No Connection
K6	VDD	Supply	Power Supply
K7	NC	Not applicable	No Connection
K8	GND	Supply	Power Ground
K9	NC	Not applicable	No Connection
K10	NC	Not applicable	No Connection

TYPICAL PERFORMANCE CHARACTERISTICS

GYROSCOPES

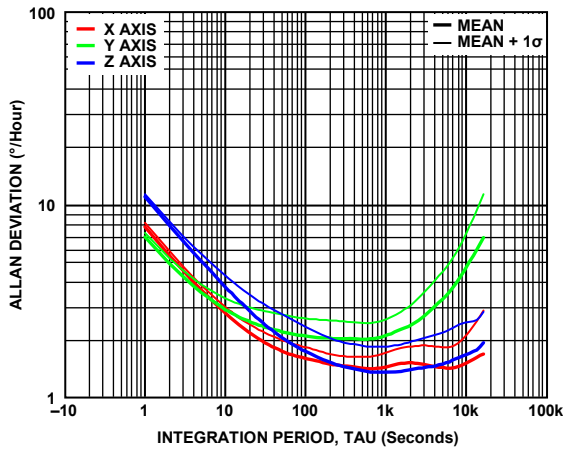

Figure 7. Gyroscope Allan Deviation, $T_C = 25^\circ\text{C}$, ADIS16505-1, Plot Taken After 10 Hours of Settling Time

17328-107

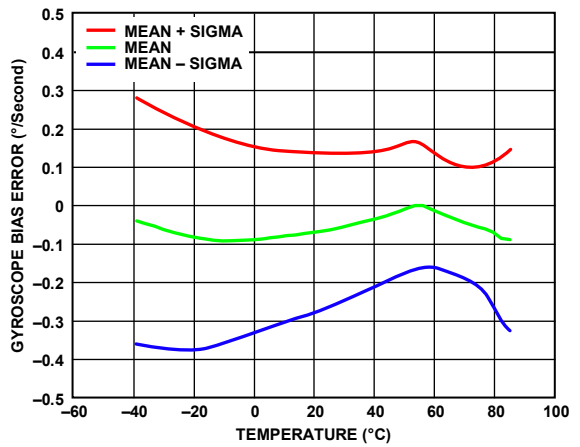

Figure 10. Gyroscope Bias Error vs. Temperature, ADIS16505-1, All Axes

17328-110

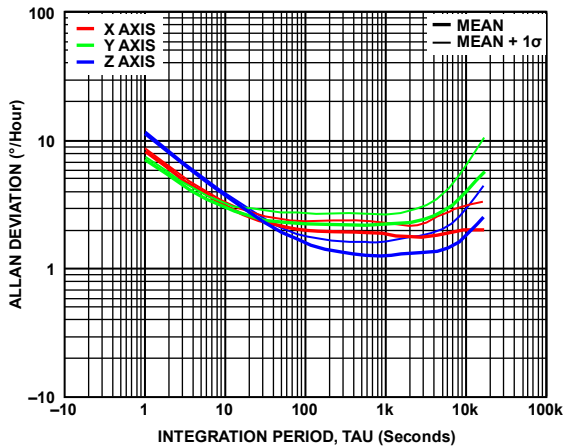

Figure 8. Gyroscope Allan Deviation, $T_C = 25^\circ\text{C}$, ADIS16505-2, Plot Taken After 10 Hours of Settling Time

17328-007

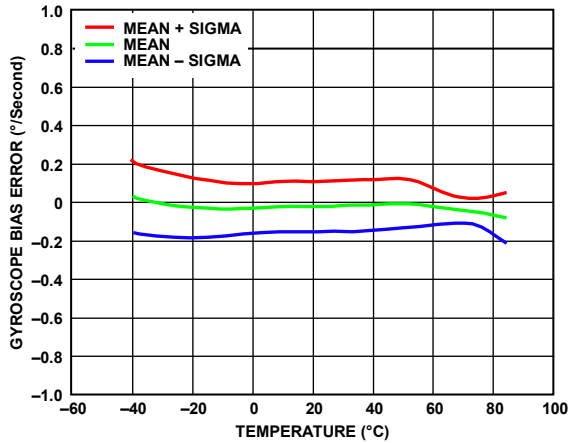

Figure 11. Gyroscope Bias Error vs. Temperature, ADIS16505-2, All Axes

17328-008

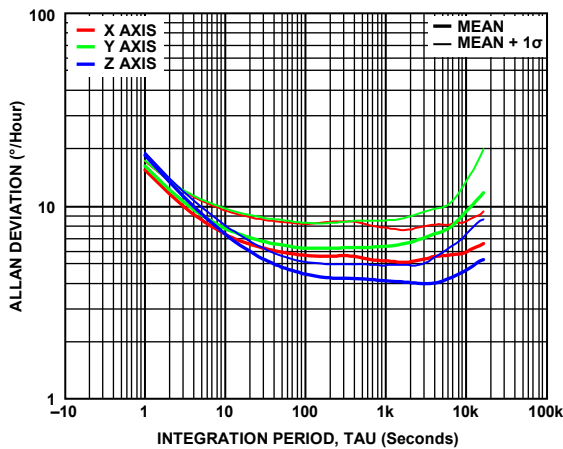

Figure 9. Gyroscope Allan Deviation, $T_C = 25^\circ\text{C}$, ADIS16505-3, Plot Taken After 10 Hours of Settling Time

17328-109

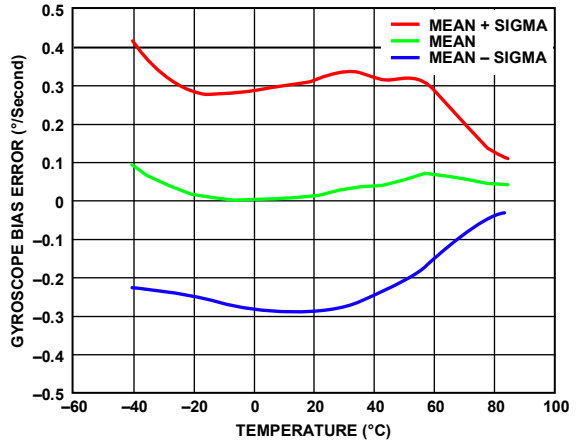

Figure 12. Gyroscope Bias Error vs. Temperature, ADIS16505-3, All Axes

17328-112

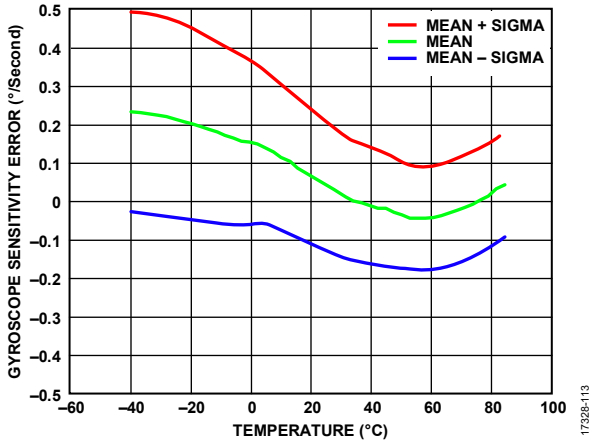

Figure 13. Gyroscope Sensitivity Error vs. Temperature, ADIS16505-1, All Axes

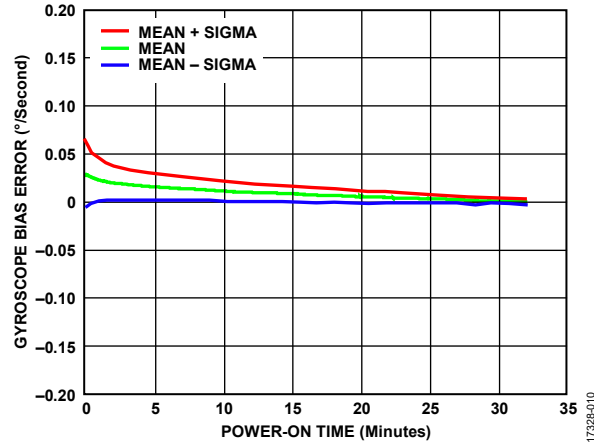

Figure 16. Gyroscope Bias Error vs. Power-On Time, $T_c = -40^\circ\text{C}$, All Axes

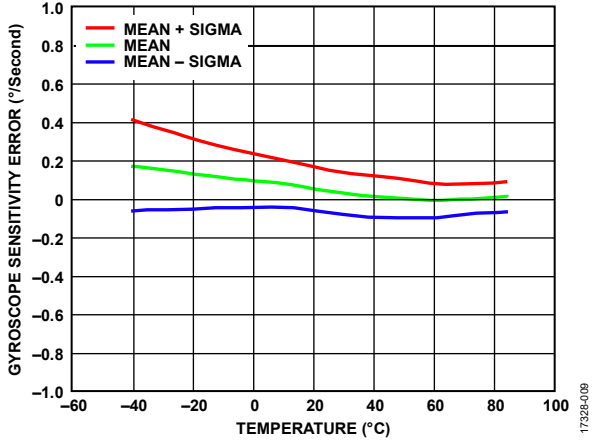

Figure 14. Gyroscope Sensitivity Error vs. Temperature, ADIS16505-2, All Axes

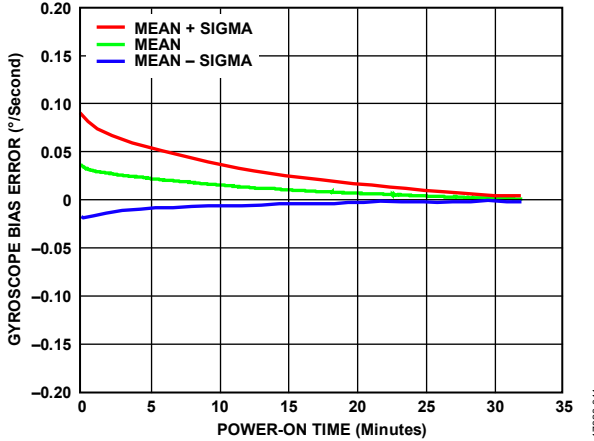

Figure 17. Gyroscope Bias Error vs. Power-On Time, $T_c = 25^\circ\text{C}$, All Axes

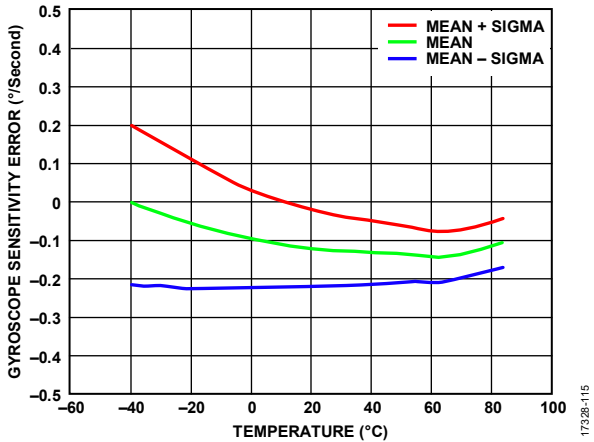

Figure 15. Gyroscope Sensitivity Error vs. Temperature, ADIS16505-3, All Axes

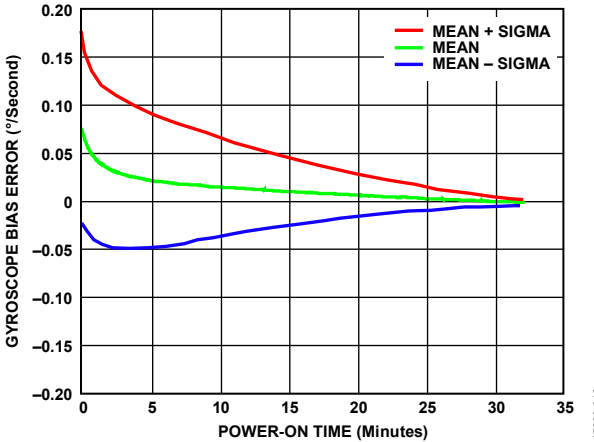

Figure 18. Gyroscope Bias Error vs. Power-On Time, $T_c = 85^\circ\text{C}$, All Axes

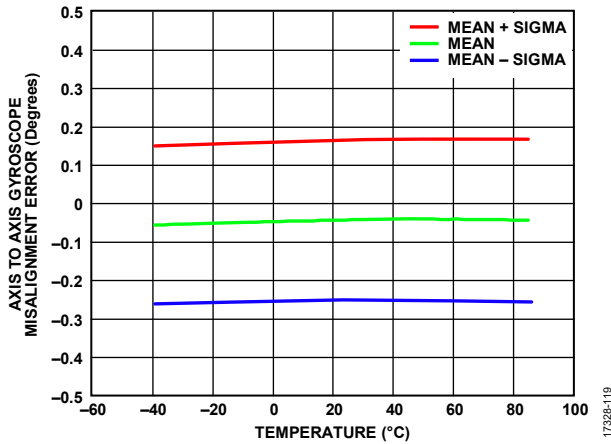

Figure 19. Axis to Axis Gyroscope Misalignment Error vs. Temperature, All Axes, ADIS16505-1

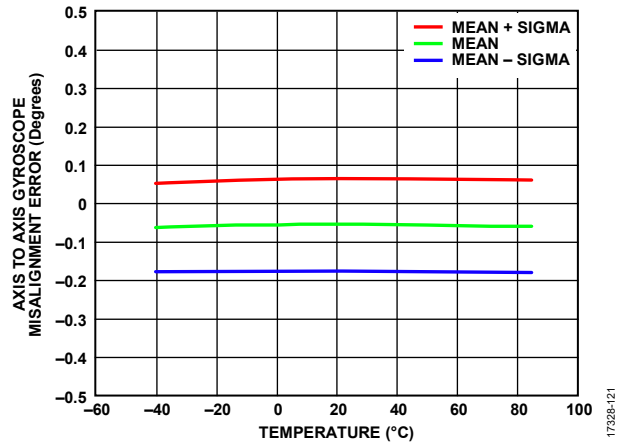

Figure 21. Axis to Axis Gyroscope Misalignment Error vs. Temperature, All Axes, ADIS16505-3

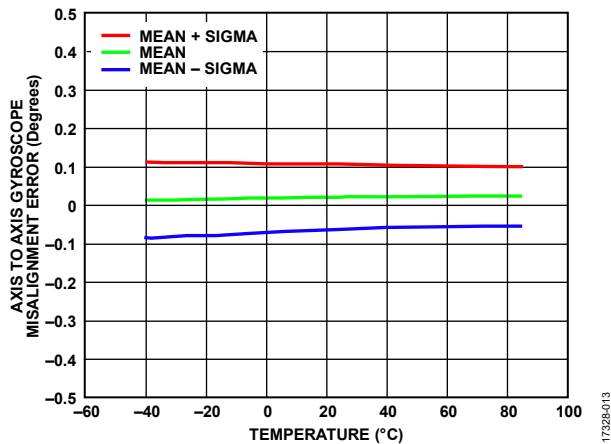

Figure 20. Axis to Axis Gyroscope Misalignment Error vs. Temperature, All Axes, ADIS16505-2

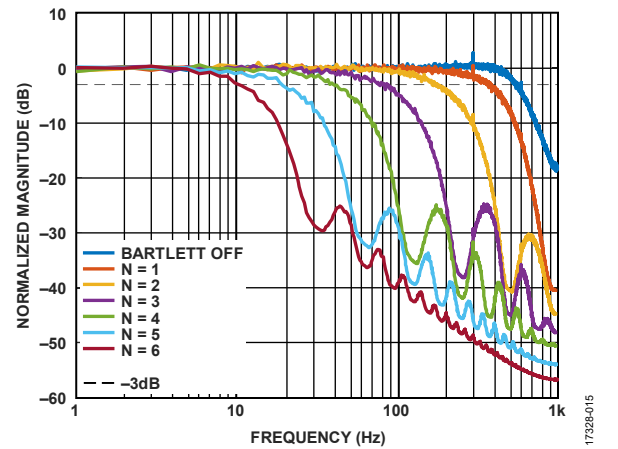

Figure 22. Normalized Gyroscope Noise Density, All Axes, $T_c = 25^\circ\text{C}$

ACCELEROMETERS

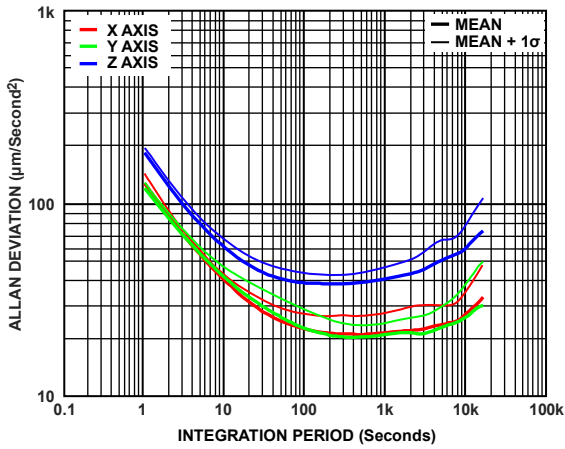

Figure 23. Accelerometer Allan Deviation, $T_c = 25^\circ\text{C}$

17328-016

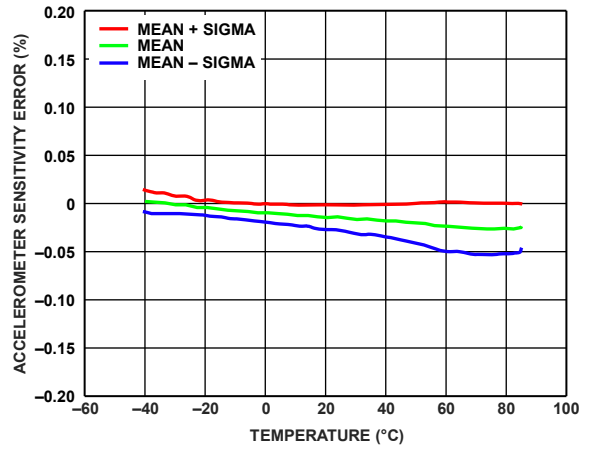

Figure 26. Accelerometer Sensitivity Error vs. Temperature, Hot to Cold, All Axes

17328-019

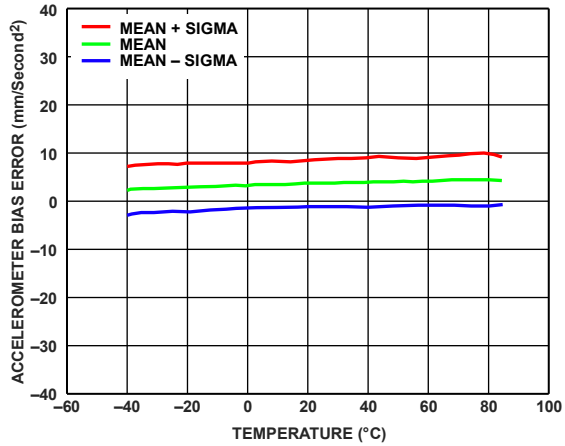

Figure 24. Accelerometer Bias Error vs. Temperature, All Axes

17328-017

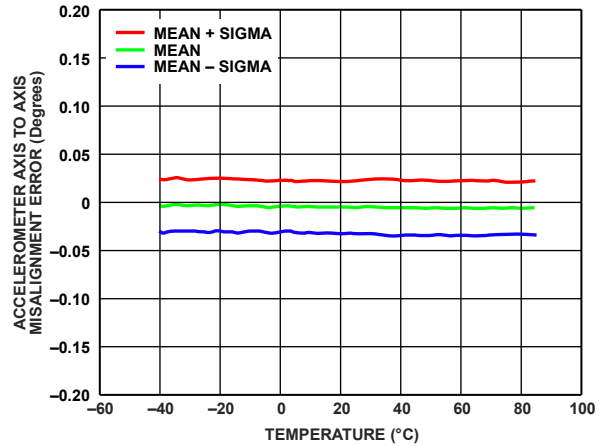

Figure 27. Accelerometer Axis to Axis Misalignment Error vs. Temperature

17328-020

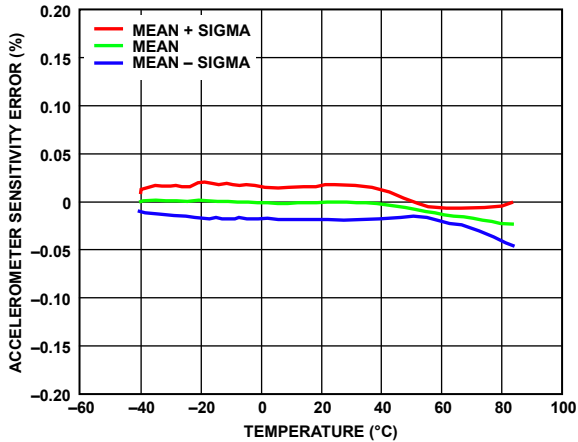

Figure 25. Accelerometer Sensitivity Error vs. Temperature, Cold to Hot, All Axes

17328-018

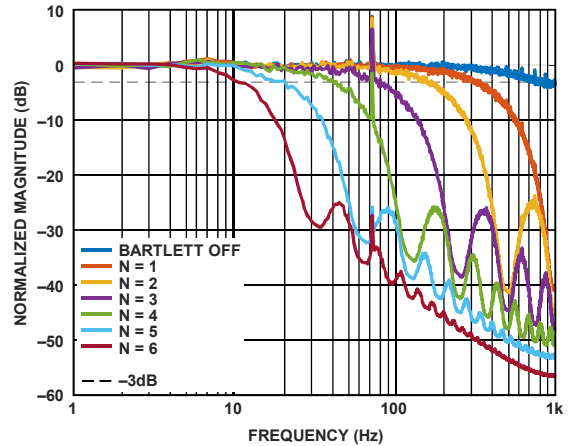

Figure 28. Accelerometer Normalized Noise Density

17328-021

THEORY OF OPERATION

INTRODUCTION

Figure 30 provides the basic signal chain for the accelerometers and gyroscopes of the ADIS16505. When using the factory default configuration, the ADIS16505 initializes itself at power-up and automatically starts a continuous process of sampling, processing, and loading calibrated sensor data into its output registers at a rate of 2000 SPS.

CLOCK CONTROL

The ADIS16505 provides four modes of operation with respect to the source of the sampling and processing clock (see the frequency sampling clock (f_{SM}) in Figure 30): internal, direct input sync, scaled sync, and output sync. The MSC_CTRL register, Bits[3:2] (see Table 105 and Table 106) provide user selection of these modes.

Note that changes to the MSC_CTRL[3:2] and UP_SCALE registers are only updated for readback after the internal clock configuration is complete. Therefore, the user must wait until the DR pin toggles before attempting to verify the desired settings by reading the values of these registers. Changes to MSC_CTRL[9:6] may take up to 200 μ s after writing to indicate to the new value during readback. The external clock must also be present for two external clock cycles if either direct input sync mode or scaled sync mode is programmed.

Internal Clock Mode

Setting MSC_CTRL register, Bits[3:2] = 00 selects the internal clock mode and is the default. In this mode, the ADIS16505 uses an internally generated clock that has a nominal frequency of 2000 Hz to drive sampling and data processing for each sensor and associated signal chain.

Direct Input Sync Mode

Setting MSC_CTRL register, Bits[3:2] = 01 selects direct input sync mode and allows f_{SM} to come directly from an external clock to control the sensor sampling using the SYNC pin as an input. When operating in input sync mode, the ADIS16505 performs best when the external clock frequency (f_{SYNC}) is between 1900 Hz and 2100 Hz.

Scaled Sync Mode

Setting MSC_CTRL register, Bits[3:2] = 10 selects scaled sync mode, which supports use of an external sync clock between 1 Hz and 128 Hz that can come from video systems or global positioning systems (GPSs). When operating in scaled sync mode, the frequency of the sample clock is equal to the product of the external clock scale factor, K_{ECSF} (from the UP_SCALE register, see Table 107 and Table 108), and the frequency of the clock signal on the SYNC pin. As in input sync mode, the ADIS16505 performs best when f_{SM} is between 1900 Hz and 2100 Hz.

Changes to the UP_SCALE register value resets the clock multiplication phase-locked loop (PLL) and restarts the locking process. The locking process starts with an input reference clock edge resetting the feedback clock edge, and lock is declared when time differences between these two edges is $\leq 100 \mu$ s.

For example, when using a 1 Hz input signal, set UP_SCALE = 0x07D0 ($K_{ECSF} = 2000$ (decimal)) to establish a sample rate of 2000 SPS for the inertial sensors and their signal processing. Use the following sequence on the DIN pin to configure UP_SCALE for this scenario: 0xE2D0, then 0xE307.

Output Sync Mode

When Register MSC_CTRL, Bits[3:2] = 11, the ADIS16505 operates in output sync mode, which is the same as internal clock mode except that the SYNC pin pulses when the internal processor collects data from the inertial sensors. Figure 29 provides an example of this signal.

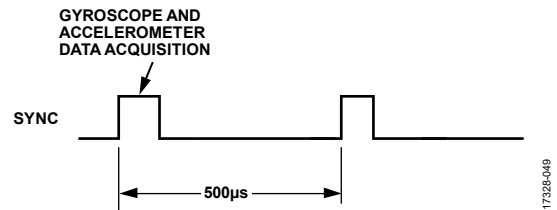

Figure 29. Sync Output Signal, Register MSC_CTRL, Bits[3:2] = 11

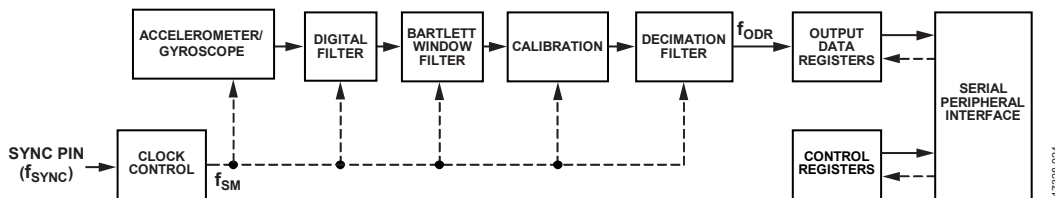

Figure 30. Sensor Signal Chain

BARTLETT WINDOW FILTER

The Bartlett window filter is a finite impulse response (FIR) filter (see Figure 31) that contains two averaging filter stages in a cascade configuration. The FILT_CTRL register (see Table 102) provides the configuration controls for this filter.

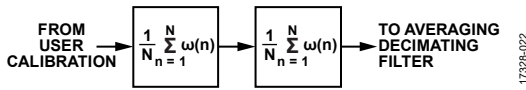

Figure 31. Bartlett Window FIR Filter Signal Path

CALIBRATION

The inertial sensor calibration function for the gyroscopes and the accelerometers has two components: factory calibration and user calibration (see Figure 32).

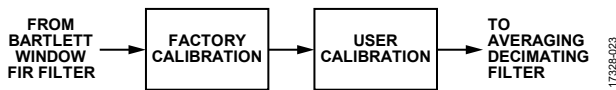

Figure 32. Inertial Sensor Calibration Processing

The factory calibration of the gyroscope applies the following correction formulas to the data of each gyroscope:

$$\begin{bmatrix} \omega_{XC} \\ \omega_{YC} \\ \omega_{ZC} \end{bmatrix} = \begin{bmatrix} m_{11} & m_{12} & m_{13} \\ m_{21} & m_{22} & m_{23} \\ m_{31} & m_{32} & m_{33} \end{bmatrix} \times \begin{bmatrix} \omega_X \\ \omega_Y \\ \omega_Z \end{bmatrix} + \begin{bmatrix} b_X \\ b_Y \\ b_Z \end{bmatrix} + \begin{bmatrix} l_{11} & l_{12} & l_{13} \\ l_{21} & l_{22} & l_{23} \\ l_{31} & l_{32} & l_{33} \end{bmatrix} \times \begin{bmatrix} a_{XC} \\ a_{YC} \\ a_{ZC} \end{bmatrix}$$

where:

- ω_{XC} , ω_{YC} , and ω_{ZC} are the gyroscope outputs (post calibration).
- m_{11} , m_{12} , m_{13} , m_{21} , m_{22} , m_{23} , m_{31} , m_{32} , and m_{33} provide scale and alignment correction.
- ω_X , ω_Y , and ω_Z are the gyroscope outputs (precalibration).
- b_X , b_Y , and b_Z provide bias correction.
- l_{11} , l_{12} , l_{13} , l_{21} , l_{22} , l_{23} , l_{31} , l_{32} , and l_{33} provide linear acceleration correction
- a_{XC} , a_{YC} , and a_{ZC} are the accelerometer outputs (post calibration).

All of the correction factors in this relationship come from direct observation of the response of each gyroscope at multiple temperatures over the calibration temperature range ($-40^\circ\text{C} \leq T_c \leq +85^\circ\text{C}$). These correction factors are stored in the flash memory bank, but they are not available for observation or configuration.

Register MSC_CTRL, Bit 7 (see Table 106) provides the only user-configurable option for the factory calibration of the gyroscopes: an on/off control for the linear acceleration compensation. See Figure 56 for more details on the user calibration options available for the gyroscopes.

The factory calibration of the accelerometer applies the following correction formulas to the data of each accelerometer:

$$\begin{bmatrix} a_{XC} \\ a_{YC} \\ a_{ZC} \end{bmatrix} = \begin{bmatrix} m_{11} & m_{12} & m_{13} \\ m_{21} & m_{22} & m_{23} \\ m_{31} & m_{32} & m_{33} \end{bmatrix} \times \begin{bmatrix} a_X \\ a_Y \\ a_Z \end{bmatrix} + \begin{bmatrix} b_X \\ b_Y \\ b_Z \end{bmatrix} + \begin{bmatrix} 0 & p_{12} & p_{13} \\ p_{21} & 0 & p_{23} \\ p_{31} & p_{32} & 0 \end{bmatrix} \times \begin{bmatrix} \omega_{XC}^2 \\ \omega_{YC}^2 \\ \omega_{ZC}^2 \end{bmatrix}$$

where:

- a_{XC} , a_{YC} , and a_{ZC} are the accelerometer outputs (post calibration).
- m_{11} , m_{12} , m_{13} , m_{21} , m_{22} , m_{23} , m_{31} , m_{32} , and m_{33} provide scale and alignment correction.
- a_X , a_Y , and a_Z are the accelerometer outputs (precalibration).
- b_X , b_Y , and b_Z provide bias correction.
- p_{12} , p_{13} , p_{21} , p_{23} , p_{31} and p_{32} provide a point of percussion alignment correction (see Figure 59).
- ω_{XC}^2 , ω_{YC}^2 , and ω_{ZC}^2 are the square of the gyroscope outputs (post calibration).

All of the correction factors in this relationship come from direct observation of the response of each accelerometer at multiple temperatures, over the calibration temperature range ($-40^\circ\text{C} \leq T_c \leq +85^\circ\text{C}$). These correction factors are stored in the flash memory bank but are not available for observation or configuration. MSC_CTRL, Bit 6 (see Table 106) provides the only user configuration option for the factory calibration of the accelerometers: an on/off control for the point of percussion, alignment function. See Figure 57 for more details on the user calibration options available for the accelerometers.

DECIMATION FILTER

The second digital filter averages multiple samples together to produce each register update. The number of samples in the average is equal to the reduction in the update rate (f_{ODR}) for the output data registers (see Figure 33). The DEC_RATE register (see Table 110) provides the configuration controls for this filter.

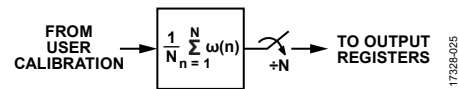

Figure 33. Decimating Filter Diagram

REGISTER STRUCTURE

All communication between the ADIS16505 and an external processor involves either reading the contents of an output register or writing configuration/command information to a control register. The output data registers include the latest sensor data, error flags, and identification information. The control registers include sample rate, filtering, calibration, and diagnostic options. Each user accessible register has two bytes (upper and lower), each of which has its own unique address. See Table 9 for a detailed list of all user registers, along with their addresses.

SPI

The SPI provides access to the user registers (see Table 9). Figure 34 shows the most common connections between the ADIS16505 and a SPI master device, which is often an embedded processor that has a SPI-compatible interface. In this example, the SPI master uses an interrupt service routine to collect data every time the data ready (DR) signal pulses.

Figure 34 shows the typical SPI connection. The 33 Ω series resistors shown in Figure 34 are recommended but not required. Additional information on the SPI can be found in the Applications Information section.

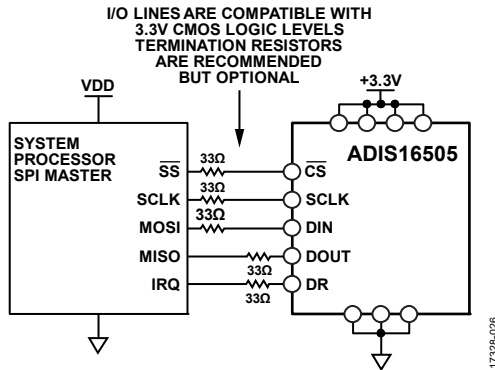

Figure 34. Electrical Connection Diagram

Table 6 provides an example list of pin names for the SPI port in an embedded processor.

Table 6. Generic SPI Master Pin Names and Functions

Mnemonic	Function
SS	Slave select
SCLK	Serial clock
MOSI	Master output, slave input
MISO	Master input, slave output
IRQ	Interrupt request

Embedded processors typically configure their serial ports for communicating with SPI slave devices such as the ADIS16505 by using control registers on the processor itself. Table 7 lists the SPI protocol settings for the ADIS16505.

Table 7. Generic Master Processor SPI Settings

Processor Setting	Description
Master	ADIS16505 operates as slave
SCLK ≤ 2 MHz ¹	Maximum serial clock rate
SPI Mode 3	CPOL = 1 (polarity), CPHA = 1 (phase)
MSB First Mode	Bit sequence, see Figure 40 for coding
16-Bit Mode	Shift register and data length

¹ A burst mode read requires this value to be ≤ 1 MHz (see Table 2 for more information).

DATA READY (DR)

The factory default configuration provides users with a DR signal on the DR pin (see Table 5), which pulses when the output data registers are updating. Connect the DR pin to an input pin on the embedded processor and configure this pin to trigger data collection on the second edge of the pulse on the DR pin. The MSC_CTRL register, Bit 0 (see Table 106), controls the polarity of this signal. In Figure 35 shows a DR signal with Register MSC_CTRL, Bit 0 = 1, meaning that data collection must start on the rising edges of the DR pulses.



Figure 35. Data Ready When Register MSC_CTRL, Bit 0 = 1 (Default)

During the start-up and reset recovery processes, the DR signal can exhibit some transient behavior before data production begins. Figure 36 shows an example of the DR behavior during startup, and Figure 37 and Figure 38 provide examples of the DR behavior during recovery from reset commands.

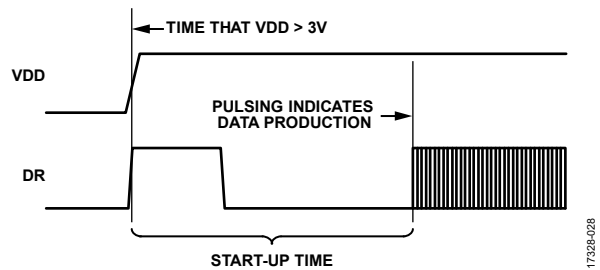

Figure 36. Data Ready Response During Startup

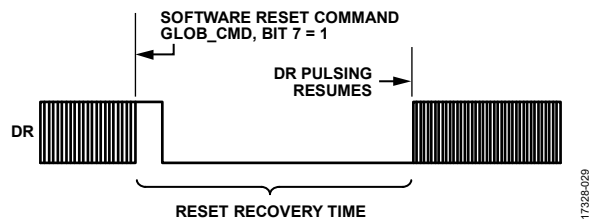

Figure 37. Data Ready Response During Reset Recovery (Register GLOB_CMD, Bit 7 = 1)

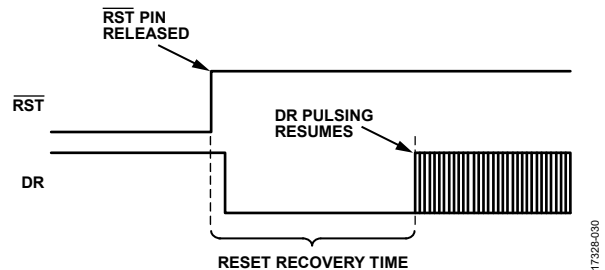

Figure 38. Data Ready Response During Reset ($\overline{RST} = 0$) Recovery

READING SENSOR DATA

Reading a single register requires two 16-bit cycles on the SPI: one to request the contents of a register and another to receive those contents. The 16-bit command code (see Figure 40) for a read request on the SPI has three parts: the read bit ($\bar{R}/W = 0$), either address of the register, [A6:A0], and eight don't care bits, [DC7:DC0]. Figure 39 shows an example that includes two register reads in succession. This example starts with DIN = 0x0C00 to request the contents of the Z_GYRO_LOW register, and follows with 0x0E00 to request the contents of the Z_GYRO_OUT register. The sequence in Figure 39 also shows full duplex mode of operation, which means that the ADIS16505 can receive

requests on DIN while also transmitting data out on DOUT within the same 16-bit SPI cycle.



Figure 39. SPI Read Example

Figure 41 provides an example of the four SPI signals when reading the PROD_ID register (see Table 120) in a repeating pattern. This pattern can be helpful when troubleshooting the SPI interface setup and communications because the signals are the same for each 16-bit sequence, except during the first cycle.

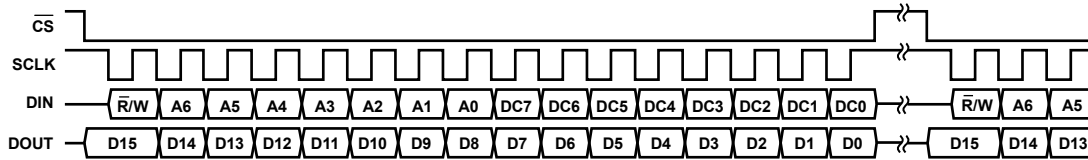

NOTES

1. DOUT BITS ARE PRODUCED ONLY WHEN THE PREVIOUS 16-BIT DIN SEQUENCE STARTS WITH $\bar{R}/W = 0$.
2. WHEN \bar{CS} IS HIGH, DOUT IS IN A THREE-STATE, HIGH IMPEDANCE MODE, WHICH ALLOWS MULTIFUNCTIONAL USE OF THE LINE FOR OTHER DEVICES.

Figure 40. SPI Communication Bit Sequence

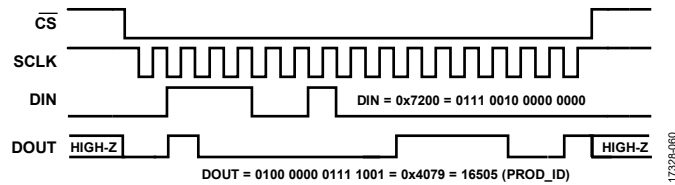

Figure 41. SPI Signal Pattern, Repeating Read of the PROD_ID Register

BURST READ FUNCTION

The burst read function provides a way to read a batch of output data registers, using a continuous stream of bits, at a rate of up to 1 MHz (SCLK). This method does not require a stall time between each 16-bit segment (see Figure 3). As shown in Figure 42, start this mode by setting DIN = 0x6800, and then read each of the registers in the sequence out of DOUT while keeping CS low for the entire data transfer sequence. However, keeping the CS pin low after a burst transfer is complete may delay the next data ready pulse and may potentially interfere with the processing of the next IMU sample.

The three options for burst mode include: scaled sync mode on or off, BURST32 enabled and disabled, and BURST_SEL = 0 or BURSET_SEL = 1. This results in eight possible burst data formats.

Scaled Sync Mode Enabled vs. Disabled

The only differences in the burst data format between these two modes are the final two bytes in a burst. In scaled sync mode, the final two bytes are the values of the TIME_STAMP registers. When scaled sync mode is disabled, the final two bytes are the values in the DATA_CNTR registers. As always, Bits[15:8] appear before Bits[7:0] in both modes.

For the rest of this section, it is assumed that scaled sync mode is disabled.

16-Bit Burst Mode with BURST_SEL = 0

In 16-bit burst mode with BURST_SEL = 0, a burst contains calibrated gyroscope and accelerometer data in 16-bit format. This mode is particularly appropriate for cases where there is no decimation nor filtering. Not only is the sample rate high (~2 kSPS), the lower 16 bits are not used unless the user is averaging or filtering.

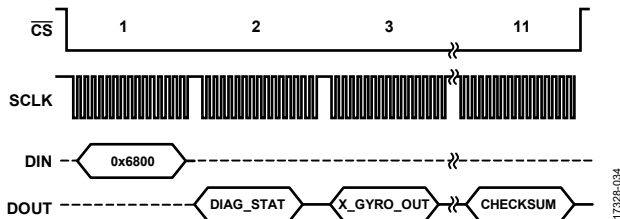

Figure 42. Burst Read Sequence with BURST_SEL = 0

The sequence of registers (and checksum value) in the burst read includes the following registers and value: DIAG_STAT, X_GYRO_OUT, Y_GYRO_OUT, Z_GYRO_OUT, X_ACCL_OUT, Y_ACCL_OUT, Z_ACCL_OUT, TEMP_OUT, DATA_CNTR, and the checksum value.

In these cases, use the following formula to verify the 16-bit checksum value, treating each byte in the formula as an independent, unsigned, 8-bit number:

$$\begin{aligned} \text{Checksum} = & \text{DIAG_STAT, Bits}[15:8] + \text{DIAG_STAT, Bits}[7:0] + \\ & \text{X_GYRO_OUT, Bits}[15:8] + \text{X_GYRO_OUT, Bits}[7:0] + \\ & \text{Y_GYRO_OUT, Bits}[15:8] + \text{Y_GYRO_OUT, Bits}[7:0] + \\ & \text{Z_GYRO_OUT, Bits}[15:8] + \text{Z_GYRO_OUT, Bits}[7:0] + \\ & \text{X_ACCL_OUT, Bits}[15:8] + \text{X_ACCL_OUT, Bits}[7:0] + \\ & \text{Y_ACCL_OUT, Bits}[15:8] + \text{Y_ACCL_OUT, Bits}[7:0] + \\ & \text{Z_ACCL_OUT, Bits}[15:8] + \text{Z_ACCL_OUT, Bits}[7:0] + \\ & \text{TEMP_OUT, Bits}[15:8] + \text{TEMP_OUT, Bits}[7:0] + \\ & \text{DATA_CNTR, Bits}[15:8] + \text{DATA_CNTR, Bits}[7:0] \end{aligned}$$

16-Bit Burst Mode with BURST_SEL = 1

In 16-bit burst mode with BURST_SEL = 1, a burst contains calibrated delta angle and delta velocity data in 16-bit format. This mode is particularly appropriate for cases where there is no decimation nor filtering. Not only is the sample rate high (~2 kSPS), the lower 16 bits are not used.

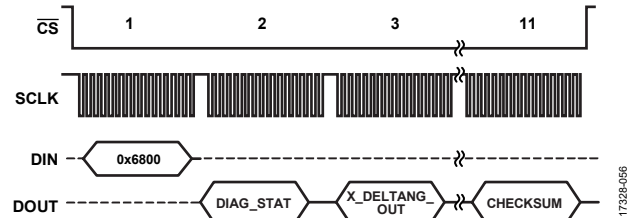

Figure 43. Burst Read Sequence with BURST_SEL = 1

The sequence of registers (and checksum value) in the burst read includes the following registers and value: DIAG_STAT, X_DELTANG_OUT, Y_DELTANG_OUT, Z_DELTANG_OUT, X_DELTVEL_OUT, Y_DELTVEL_OUT, Z_DELTVEL_OUT, TEMP_OUT, DATA_CNTR, and the checksum value.

In these cases, use the following formula to verify the 16-bit checksum value, treating each byte in the formula as an independent, unsigned, 8-bit number:

$$\begin{aligned} \text{Checksum} = & \text{DIAG_STAT, Bits}[15:8] + \text{DIAG_STAT, Bits}[7:0] + \\ & \text{X_DELTANG_OUT, Bits}[15:8] + \text{X_DELTANG_OUT, Bits}[7:0] + \\ & \text{Y_DELTANG_OUT, Bits}[15:8] + \text{Y_DELTANG_OUT, Bits}[7:0] + \\ & \text{Z_DELTANG_OUT, Bits}[15:8] + \text{Z_DELTANG_OUT, Bits}[7:0] + \\ & \text{X_DELTVEL_OUT, Bits}[15:8] + \text{X_DELTVEL_OUT, Bits}[7:0] + \\ & \text{Y_DELTVEL_OUT, Bits}[15:8] + \text{Y_DELTVEL_OUT, Bits}[7:0] + \\ & \text{Z_DELTVEL_OUT, Bits}[15:8] + \text{Z_DELTVEL_OUT, Bits}[7:0] + \\ & \text{TEMP_OUT, Bits}[15:8] + \text{TEMP_OUT, Bits}[7:0] + \\ & \text{DATA_CNTR, Bits}[15:8] + \text{DATA_CNTR, Bits}[7:0] \end{aligned}$$

32-Bit Burst Mode with BURST_SEL = 0

In 32-bit burst mode with BURST_SEL = 0, a burst contains calibrated gyroscope and accelerometer data in 32-bit format. This mode is appropriate for cases where there is averaging (decimation) and/or low-pass filtering of the data.

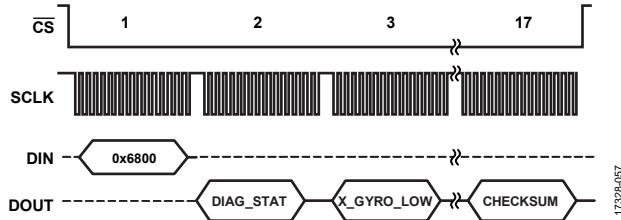

Figure 44. Burst Read Sequence with BURST_SEL = 0

The sequence of registers (and checksum value) in the burst read includes the following registers and value: DIAG_STAT, X_GYRO_LOW, X_GYRO_OUT, Y_GYRO_LOW, Y_GYRO_OUT, Z_GYRO_LOW, Z_GYRO_OUT, X_ACCL_LOW, X_ACCL_OUT, Y_ACCL_LOW, Y_ACCL_OUT, Z_ACCL_LOW, Z_ACCL_OUT, TEMP_OUT, DATA_CNTR, and the checksum value. In these cases, use the following formula to verify the 16-bit checksum value, treating each byte in the formula as an independent, unsigned, 8-bit number:

$$\begin{aligned} \text{Checksum} = & \text{DIAG_STAT, Bits}[15:8] + \text{DIAG_STAT, Bits}[7:0] + \\ & \text{X_GYRO_LOW, Bits}[15:8] + \text{X_GYRO_LOW, Bits}[7:0] + \\ & \text{X_GYRO_OUT, Bits}[15:8] + \text{X_GYRO_OUT, Bits}[7:0] + \\ & \text{Y_GYRO_LOW, Bits}[15:8] + \text{Y_GYRO_LOW, Bits}[7:0] + \\ & \text{Y_GYRO_OUT, Bits}[15:8] + \text{Y_GYRO_OUT, Bits}[7:0] + \\ & \text{Z_GYRO_LOW, Bits}[15:8] + \text{Z_GYRO_LOW, Bits}[7:0] + \\ & \text{Z_GYRO_OUT, Bits}[15:8] + \text{Z_GYRO_OUT, Bits}[7:0] + \\ & \text{X_ACCL_LOW, Bits}[15:8] + \text{X_ACCL_LOW, Bits}[7:0] + \\ & \text{X_ACCL_OUT, Bits}[15:8] + \text{X_ACCL_OUT, Bits}[7:0] + \\ & \text{Y_ACCL_LOW, Bits}[15:8] + \text{Y_ACCL_LOW, Bits}[7:0] + \\ & \text{Y_ACCL_OUT, Bits}[15:8] + \text{Y_ACCL_OUT, Bits}[7:0] + \\ & \text{Z_ACCL_LOW, Bits}[15:8] + \text{Z_ACCL_LOW, Bits}[7:0] + \\ & \text{Z_ACCL_OUT, Bits}[15:8] + \text{Z_ACCL_OUT, Bits}[7:0] + \\ & \text{TEMP_OUT, Bits}[15:8] + \text{TEMP_OUT, Bits}[7:0] + \\ & \text{DATA_CNTR, Bits}[15:8] + \text{DATA_CNTR, Bits}[7:0] \end{aligned}$$

32-Bit Burst Mode with BURST_SEL = 1

In 32-bit burst mode with BURST_SEL = 1, a burst contains calibrated delta angle and delta velocity data in 32-bit format. This mode is appropriate for cases where there is averaging (decimation) and/or low-pass filtering of the data.

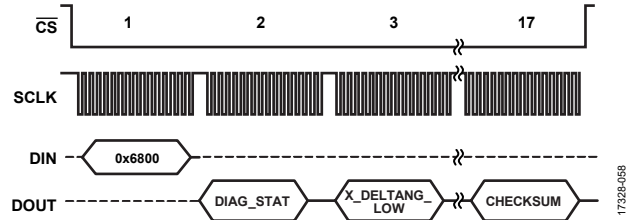

Figure 45. Burst Read Sequence with BURST_SEL = 1

The sequence of registers (and checksum value) in the burst read includes the following registers and value: DIAG_STAT, X_DELTANG_LOW, X_DELTANG_OUT, Y_DELTANG_LOW, Y_DELTANG_OUT, Z_DELTANG_LOW, Z_DELTANG_OUT, X_DELTVEL_LOW, X_DELTVEL_OUT, Y_DELTVEL_LOW, Y_DELTVEL_OUT, Z_DELTVEL_LOW, Z_DELTVEL_OUT, TEMP_OUT, DATA_CNTR, and the checksum value. In these cases, use the following formula to verify the 16-bit checksum value, treating each byte in the formula as an independent, unsigned, 8-bit number:

$$\begin{aligned} \text{Checksum} = & \text{DIAG_STAT, Bits}[15:8] + \text{DIAG_STAT, Bits}[7:0] + \\ & \text{X_DELTANG_LOW, Bits}[15:8] + \text{X_DELTANG_LOW, Bits}[7:0] + \\ & \text{X_DELTANG_OUT, Bits}[15:8] + \text{X_DELTANG_OUT, Bits}[7:0] + \\ & \text{Y_DELTANG_LOW, Bits}[15:8] + \text{Y_DELTANG_LOW, Bits}[7:0] + \\ & \text{Y_DELTANG_OUT, Bits}[15:8] + \text{Y_DELTANG_OUT, Bits}[7:0] + \\ & \text{Z_DELTANG_LOW, Bits}[15:8] + \text{Z_DELTANG_LOW, Bits}[7:0] + \\ & \text{Z_DELTANG_OUT, Bits}[15:8] + \text{Z_DELTANG_OUT, Bits}[7:0] + \\ & \text{X_DELTVEL_LOW, Bits}[15:8] + \text{X_DELTVEL_LOW, Bits}[7:0] + \\ & \text{X_DELTVEL_OUT, Bits}[15:8] + \text{X_DELTVEL_OUT, Bits}[7:0] + \\ & \text{Y_DELTVEL_LOW, Bits}[15:8] + \text{Y_DELTVEL_LOW, Bits}[7:0] + \\ & \text{Y_DELTVEL_OUT, Bits}[15:8] + \text{Y_DELTVEL_OUT, Bits}[7:0] + \\ & \text{Z_DELTVEL_LOW, Bits}[15:8] + \text{Z_DELTVEL_LOW, Bits}[7:0] + \\ & \text{Z_DELTVEL_OUT, Bits}[15:8] + \text{Z_DELTVEL_OUT, Bits}[7:0] + \\ & \text{TEMP_OUT, Bits}[15:8] + \text{TEMP_OUT, Bits}[7:0] + \\ & \text{DATA_CNTR, Bits}[15:8] + \text{DATA_CNTR, Bits}[7:0] \end{aligned}$$

LATENCY

Table 8 contains the group delay for each inertial sensor when the ADIS16505 is operating with the factory default settings for the FILT_CTRL (see Table 101) and DEC_RATE (see Table 109) registers.

Table 8. Group Delay with No Filtering

Inertial Sensor	Group Delay (ms) ¹
Accelerometer	1.57
Gyroscope (X-Axis)	1.51
Gyroscope (Y-Axis)	1.51
Gyroscope (Z-Axis)	1.29

¹ In this context, latency represents the time between the motion (linear acceleration and/or angular rate of rotation) and the time that the representative data is available in the output data register.

When the FILT_CTRL register is not equal to 0, the group delay contribution of the Bartlett window filter (in terms of sample cycles) is equal to N (see Table 102). When the DEC_RATE register is not equal to 0, the group delay contribution of the decimation filter (in terms of sample cycles) is equal D + 1, divided by 2 (see Table 110).

Data Acquisition

The total latency is equal to the sum of the group delay and the data acquisition time, which represents the time it takes the system processor to read the data from the output data registers of the ADIS16505. For example, when using the burst read function, with an SCLK rate of 1 MHz, the data acquisition time is equal to 176 μs (11 segments × 16 SCLKs/segment × 1 μs/SCLK).

DEVICE CONFIGURATION

Each configuration register contains 16 bits (two bytes). Bits[7:0] contain the low byte, and Bits[15:8] contain the high byte. Each byte has its own unique address in the user register map (see Table 9). Updating the contents of a register requires writing to both of its bytes in the following sequence: low byte first, high byte second. There are three parts to coding a SPI command (see Figure 40) that write a new byte of data to a register: the write bit ($\bar{R}/W = 1$), the address of the byte, [A6:A0], and the new

data for that location, [DC7:DC0]. Figure 46 shows a coding example for writing 0x0004 to the FILT_CTRL register (see Table 102). In Figure 46, the 0xDC04 command writes 0x04 to Address 0x5C (lower byte) and the 0xDD00 command writes 0x00 to Address 0x5D (upper byte).

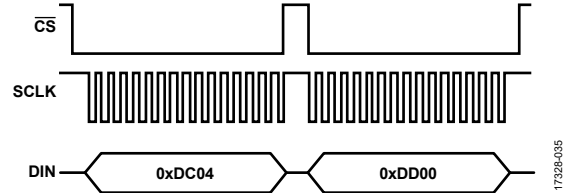

Figure 46. SPI Sequence for Writing 0x0004 to FILT_CTRL

MEMORY STRUCTURE

Figure 47 provides a functional diagram for the memory structure of the ADIS16505. The flash memory bank contains the operational code, unit specific calibration coefficients, and user configuration settings. During initialization (power application or reset recover), this information loads from the flash memory into the static random access memory (SRAM), which supports all normal operation including register access through the SPI port. Writing to a configuration register using the SPI updates the SRAM location of the register but does not automatically update its settings in the flash memory bank. The manual flash memory update command (Register GLOB_CMD, Bit 3, see Table 112) provides a convenient method for saving all of these settings to the flash memory bank at one time. A yes in the flash backup column of Table 9 identifies the registers that have storage support in the flash memory bank.

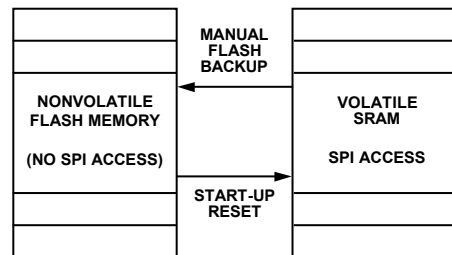

Figure 47. SRAM and Flash Memory Diagram

USER REGISTER MEMORY MAP

Table 9. User Register Memory Map (N/A Means Not Applicable)

Name	R/W	Flash Backup	Address	Default	Register Description
Reserved	N/A	N/A	0x00, 0x01	N/A	Reserved
DIAG_STAT	R	No	0x02, 0x03	0x0000	Output, system error flags
X_GYRO_LOW	R	No	0x04, 0x05	N/A	Output, x-axis gyroscope, low word
X_GYRO_OUT	R	No	0x06, 0x07	N/A	Output, x-axis gyroscope, high word
Y_GYRO_LOW	R	No	0x08, 0x09	N/A	Output, y-axis gyroscope, low word
Y_GYRO_OUT	R	No	0x0A, 0x0B	N/A	Output, y-axis gyroscope, high word
Z_GYRO_LOW	R	No	0x0C, 0x0D	N/A	Output, z-axis gyroscope, low word
Z_GYRO_OUT	R	No	0x0E, 0x0F	N/A	Output, z-axis gyroscope, high word
X_ACCL_LOW	R	No	0x10, 0x11	N/A	Output, x-axis accelerometer, low word
X_ACCL_OUT	R	No	0x12, 0x13	N/A	Output, x-axis accelerometer, high word
Y_ACCL_LOW	R	No	0x14, 0x15	N/A	Output, y-axis accelerometer, low word
Y_ACCL_OUT	R	No	0x16, 0x17	N/A	Output, y-axis accelerometer, high word
Z_ACCL_LOW	R	No	0x18, 0x19	N/A	Output, z-axis accelerometer, low word
Z_ACCL_OUT	R	No	0x1A, 0x1B	N/A	Output, z-axis accelerometer, high word
TEMP_OUT	R	No	0x1C, 0x1D	N/A	Output, temperature
TIME_STAMP	R	No	0x1E, 0x1F	N/A	Output, time stamp
Reserved	N/A	N/A	0x20, 0x21	N/A	Reserved
DATA_CNTR	R	No	0x22, 0x23	N/A	New data counter
X_DELTANG_LOW	R	No	0x24, 0x25	N/A	Output, x-axis delta angle, low word
X_DELTANG_OUT	R	No	0x26, 0x27	N/A	Output, x-axis delta angle, high word
Y_DELTANG_LOW	R	No	0x28, 0x29	N/A	Output, y-axis delta angle, low word
Y_DELTANG_OUT	R	No	0x2A, 0x2B	N/A	Output, y-axis delta angle, high word
Z_DELTANG_LOW	R	No	0x2C, 0x2D	N/A	Output, z-axis delta angle, low word
Z_DELTANG_OUT	R	No	0x2E, 0x2F	N/A	Output, z-axis delta angle, high word
X_DELTVEL_LOW	R	No	0x30, 0x31	N/A	Output, x-axis delta velocity, low word
X_DELTVEL_OUT	R	No	0x32, 0x33	N/A	Output, x-axis delta velocity, high word
Y_DELTVEL_LOW	R	No	0x34, 0x35	N/A	Output, y-axis delta velocity, low word
Y_DELTVEL_OUT	R	No	0x36, 0x37	N/A	Output, y-axis delta velocity, high word
Z_DELTVEL_LOW	R	No	0x38, 0x39	N/A	Output, z-axis delta velocity, low word
Z_DELTVEL_OUT	R	No	0x3A, 0x3B	N/A	Output, z-axis delta velocity, high word
Reserved	N/A	N/A	0x3C to 0x3F	N/A	Reserved
XG_BIAS_LOW	R/W	Yes	0x40, 0x41	0x0000	Calibration, offset, gyroscope, x-axis, low word
XG_BIAS_HIGH	R/W	Yes	0x42, 0x43	0x0000	Calibration, offset, gyroscope, x-axis, high word
YG_BIAS_LOW	R/W	Yes	0x44, 0x45	0x0000	Calibration, offset, gyroscope, y-axis, low word
YG_BIAS_HIGH	R/W	Yes	0x46, 0x47	0x0000	Calibration, offset, gyroscope, y-axis, high word
ZG_BIAS_LOW	R/W	Yes	0x48, 0x49	0x0000	Calibration, offset, gyroscope, z-axis, low word
ZG_BIAS_HIGH	R/W	Yes	0x4A, 0x4B	0x0000	Calibration, offset, gyroscope, z-axis, high word
XA_BIAS_LOW	R/W	Yes	0x4C, 0x4D	0x0000	Calibration, offset, accelerometer, x-axis, low word
XA_BIAS_HIGH	R/W	Yes	0x4E, 0x4F	0x0000	Calibration, offset, accelerometer, x-axis, high word
YA_BIAS_LOW	R/W	Yes	0x50, 0x51	0x0000	Calibration, offset, accelerometer, y-axis, low word
YA_BIAS_HIGH	R/W	Yes	0x52, 0x53	0x0000	Calibration, offset, accelerometer, y-axis, high word
ZA_BIAS_LOW	R/W	Yes	0x54, 0x55	0x0000	Calibration, offset, accelerometer, z-axis, low word
ZA_BIAS_HIGH	R/W	Yes	0x56, 0x57	0x0000	Calibration, offset, accelerometer, z-axis, high word
Reserved	N/A	N/A	0x58 to 0x5B	N/A	Reserved
FILT_CTRL	R/W	Yes	0x5C, 0x5D	0x0000	Control, Bartlett window FIR filter
RANG_MDL	R	No	0x5E, 0x5F	N/A ¹	Measurement range (model specific) identifier

Name	R/W	Flash Backup	Address	Default	Register Description
MSC_CTRL	R/W	Yes	0x60, 0x61	0x00C1	Control, input/output and other miscellaneous options
UP_SCALE	R/W	Yes	0x62, 0x63	0x07D0	Control, scale factor for input clock, scaled sync mode
DEC_RATE	R/W	Yes	0x64, 0x65	0x0000	Control, decimation filter (output data rate)
Reserved	N/A	N/A	0x66, 0x67	N/A	Reserved
GLOB_CMD	W	No	0x68, 0x69	N/A	Control, global commands
Reserved	N/A	N/A	0x6A to 0x6B	N/A	Reserved
FIRM_REV	R	Yes	0x6C, 0x6D	N/A	Identification, firmware revision
FIRM_DM	R	Yes	0x6E, 0x6F	N/A	Identification, date code, day and month
FIRM_Y	R	Yes	0x70, 0x71	N/A	Identification, date code, year
PROD_ID	R	Yes	0x72, 0x73	0x4079	Identification, device number (0x4079 = 16,505 decimal)
SERIAL_NUM	R	Yes	0x74, 0x75	N/A	Identification, serial number
USER_SCR_1	R/W	Yes	0x76, 0x77	N/A	User Scratch Register 1
USER_SCR_2	R/W	Yes	0x78, 0x79	N/A	User Scratch Register 2
USER_SCR_3	R/W	Yes	0x7A, 0x7B	N/A	User Scratch Register 3
FLSHCNT_LOW	R	Yes	0x7C, 0x7D	N/A	Output, flash memory write cycle counter, lower word
FLSHCNT_HIGH	R	Yes	0x7E, 0x7E	N/A	Output, flash memory write cycle counter, upper word

¹ See Table 103 for the model specific default value for this register.

USER REGISTER DEFINITIONS

Status/Error Flag Indicators (DIAG_STAT)

Table 10. DIAG_STAT Register Definition

Addresses	Default	Access	Flash Backup
0x02, 0x03	0x0000	R	No

Table 11. DIAG_STAT Bit Assignments

Bits	Description
[15:11]	Reserved.
10	Accelerometer failure. A 1 indicates failure of the accelerometer at the conclusion of the self test (Register GLOB_CMD, Bit 2, see Table 112). If this error occurs, repeat the same test. If this error persists, replace the ADIS16507. Motion during this test may cause a false failure.
9	Gyroscope 2 failure. A 1 indicates failure of Gyroscope 2 at the conclusion of the self test (Register GLOB_CMD, Bit 2, see Table 112). If this error occurs, repeat the same test. If this error persists, replace the ADIS16507. Motion during this test may cause a false failure.
8	Gyroscope 1 failure. A 1 indicates failure of Gyroscope 1 at the conclusion of the self test (Register GLOB_CMD, Bit 2, see Table 112). If this error occurs, repeat the same test. If this error persists, replace the ADIS16507. Motion during this test may cause a false failure.
7	Clock error. A 1 indicates that the internal data sampling clock (f_{SM} , see Figure 30) does not synchronize with the external clock, which only applies when using scaled sync mode (Register MSC_CTRL, Bits[3:2] = 10, see Table 106). When this error occurs, adjust the frequency of the clock signal on the SYNC pin to operate within the appropriate range.
6	Memory failure. A 1 indicates a failure in the flash memory test (Register GLOB_CMD, Bit 4, see Table 112), which involves a comparison between a cyclic redundancy check (CRC) calculation of the present flash memory and a CRC calculation from the same memory locations at the time of initial programming (during the production process). If this error occurs, repeat the same test. If this error persists, replace the ADIS16505.
5	Sensor failure. A 1 indicates failure of at least one sensor, at the conclusion of the self test (Register GLOB_CMD, Bit 2, see Table 112). If this error occurs, repeat the same test. If this error persists, replace the ADIS16505. Motion during this test may cause a false failure.
4	Standby mode. A 1 indicates that the voltage across VDD and GND is <2.8 V, which causes data processing to stop. When VDD ≥ 2.8 V for 250 ms, the ADIS16505 reinitializes itself and starts producing data again.
3	SPI communication error. A 1 indicates that the total number of SCLK cycles is not equal to an integer multiple of 16. When this error occurs, repeat the previous communication sequence. Persistence in this error can indicate that the SPI connection between the host and the ADIS16505 is not robust (for example, marginal voltage levels, timing, or signal integrity).

Bits	Description
2	Flash memory update failure. A 1 indicates that the most recent flash memory update (Register GLOB_CMD, Bit 3, see Table 112) failed. If this error occurs, ensure that VDD ≥ 3 V and repeat the update attempt. If this error persists, replace the ADIS16505.
1	Data path overrun. A 1 indicates that one of the data paths experienced an overrun condition. If this error occurs, initiate a reset using the \overline{RST} pin (see Table 5, Pin F3) or Register GLOB_CMD, Bit 7 (see Table 112).
0	Reserved.

The DIAG_STAT register (see Table 10 and Table 11) provides error flags for monitoring the integrity and operation of the ADIS16505. Reading this register resets its bits to 0. The error flags in DIAG_STAT are sticky, meaning that when they raise to a 1, they remain there until a read request clears them. If an error condition persists, the flag (bit) automatically returns to an alarm value of 1.

GYROSCOPE DATA

The gyroscopes in the ADIS16505 measure the angular rate of rotation around three orthogonal axes (x, y, and z). Figure 48 shows the orientation of each gyroscope axis along with the direction of rotation that produces a positive response in each of their measurements.

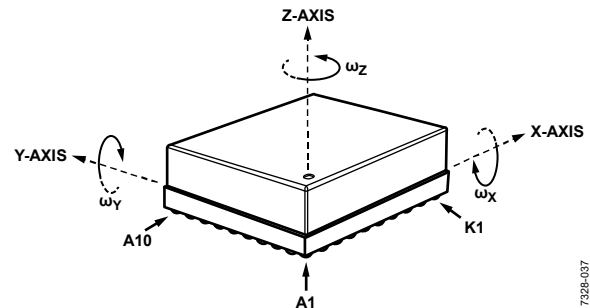

Figure 48. Gyroscope Axis and Polarity Assignments

Each gyroscope has two output data registers. Figure 49 shows how these two registers combine to support a 32-bit, twos complement data format for the x-axis gyroscope measurements. This format also applies to the y- and z-axes.

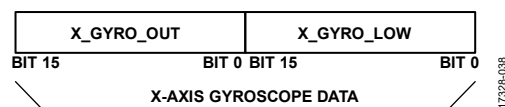

Figure 49. Gyroscope Output Data Structure

Gyroscope Measurement Range/Scale Factor

Table 12 provides the range and scale factor for the angular rate (gyroscope) measurements in each ADIS16505 model.

Table 12. Gyroscope Measurement Range and Scale Factors

Model	Range, $\pm\omega_{MAX}$ (°/sec)	Scale Factor, K_G (°/sec/LSB)
ADIS16505-1BMLZ	± 125	0.00625
ADIS16505-2BMLZ	± 500	0.025
ADIS16505-3BMLZ	± 2000	0.1

Gyroscope Data Formatting

Table 13 and Table 14 offer various numerical examples that demonstrate the format of the rotation rate data in both 16-bit and 32-bit formats.

Table 13. 16-Bit Gyroscope Data Format Examples

Rotation Rate	Decimal	Hex	Binary
$+\omega_{MAX}$	+20,000	0x4E20	0100 1110 0010 0000
$+2 K_G$	+2	0x0002	0000 0000 0000 0010
$+K_G$	+1	0x0001	0000 0000 0000 0001
0°/sec	0	0x0000	0000 0000 0000 0000
$-K_G$	-1	0xFFFF	1111 1111 1111 1111
$-2 K_G$	-2	0xFFFFE	1111 1111 1111 1110
$-\omega_{MAX}$	-20,000	0xB1E0	1011 0001 1110 0000

Table 14. 32-Bit Gyroscope Data Format Examples

Rotation Rate (°/sec)	Decimal	Hex
$+\omega_{MAX}$	+1,310,720,000	0x4E200000
$+K_G/2^{15}$	+2	0x00000002
$+K_G/2^{16}$	+1	0x00000001
0	0	0x00000000
$-K_G/2^{16}$	-1	0xFFFFFFF
$-K_G/2^{15}$	-2	0xFFFFFFF
$-\omega_{MAX}$	-1,310,720,000	0xB1E00000

X-Axis Gyroscope (X_GYRO_LOW and X_GYRO_OUT)

Table 15. X_GYRO_LOW Register Definition

Addresses	Default	Access	Flash Backup
0x04, 0x05	Not applicable	R	No

Table 16. X_GYRO_LOW Bit Definitions

Bits	Description
[15:0]	X-axis gyroscope data; additional resolution bits

Table 17. X_GYRO_OUT Register Definition

Addresses	Default	Access	Flash Backup
0x06, 0x07	Not applicable	R	No

Table 18. X_GYRO_OUT Bit Definitions

Bits	Description
[15:0]	X-axis gyroscope data; high word; twos complement, 0°/sec = 0x0000, 1 LSB = K_G (See Table 12 for K_G)

The X_GYRO_LOW (see Table 15 and Table 16) and X_GYRO_OUT (see Table 17 and Table 18) registers contain the gyroscope data for the x-axis.

Y-Axis Gyroscope (Y_GYRO_LOW and Y_GYRO_OUT)

Table 19. Y_GYRO_LOW Register Definition

Addresses	Default	Access	Flash Backup
0x08, 0x09	Not applicable	R	No

Table 20. Y_GYRO_LOW Bit Definitions

Bits	Description
[15:0]	Y-axis gyroscope data; additional resolution bits

Table 21. Y_GYRO_OUT Register Definition

Addresses	Default	Access	Flash Backup
0x0A, 0x0B	Not applicable	R	No

Table 22. Y_GYRO_OUT Bit Definitions

Bits	Description
[15:0]	Y-axis gyroscope data; high word; twos complement, 0°/sec = 0x0000, 1 LSB = K_G (see Table 12 for K_G)

The Y_GYRO_LOW (see Table 19 and Table 20) and Y_GYRO_OUT (see Table 21 and Table 22) registers contain the gyroscope data for the y-axis.

Z-Axis Gyroscope (Z_GYRO_LOW and Z_GYRO_OUT)

Table 23. Z_GYRO_LOW Register Definition

Addresses	Default	Access	Flash Backup
0x0C, 0x0D	Not applicable	R	No

Table 24. Z_GYRO_LOW Bit Definitions

Bits	Description
[15:0]	Z-axis gyroscope data; additional resolution bits

Table 25. Z_GYRO_OUT Register Definition

Addresses	Default	Access	Flash Backup
0x0E, 0x0F	Not applicable	R	No

Table 26. Z_GYRO_OUT Bit Definitions

Bits	Description
[15:0]	Z-axis gyroscope data; high word; twos complement, 0°/sec = 0x0000, 1 LSB = K_G (see Table 12 for K_G)

The Z_GYRO_LOW (see Table 23 and Table 24) and Z_GYRO_OUT (see Table 25 and Table 26) registers contain the gyroscope data for the z-axis.

Acceleration Data

The accelerometers in the ADIS16505 measure both dynamic and static (response to gravity) acceleration along the same three orthogonal axes that define the axes of rotation for the gyroscopes (x, y, and z). Figure 50 shows the orientation of each accelerometer axis along with the direction of acceleration that produces a positive response in each of their measurements.

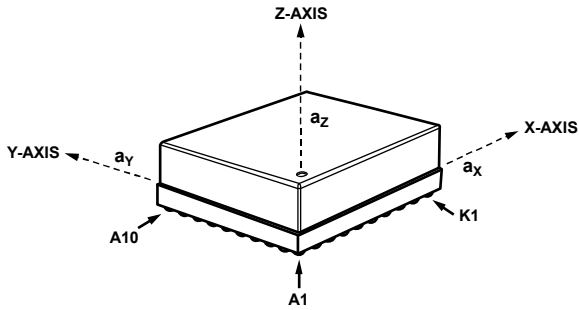

Figure 50. Accelerometer Axis and Polarity Assignments

Each accelerometer has two output data registers. Figure 51 shows how these two registers combine to support a 32-bit, twos complement data format for the x-axis accelerometer measurements. This format also applies to the y- and z-axes.

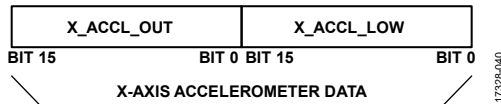

Figure 51. Accelerometer Output Data Structure

Accelerometer Resolution

Table 27 and Table 28 offer various numerical examples that demonstrate the format of the linear acceleration data in both 16-bit and 32-bit formats.

Table 27. 16-Bit Accelerometer Data Format Examples

Acceleration	Dec	Hex	Binary
+78.3 m/sec ²	+32,000	0x7D00	0111 1101 0000 0000
+4.9 mm/sec ²	+2	0x0002	0000 0000 0000 0010
+2.45 mm/sec ²	+1	0x0001	0000 0000 0000 0001
0	0	0x0000	0000 0000 0000 0000
-2.45 mm/sec ²	-1	0xFFFF	1111 1111 1111 1111
-4.9 mm/sec ²	-2	0xFFFFE	1111 1111 1111 1110
-78.3 m/sec ²	-32,000	0x8300	1000 0011 0000 0000

Table 28. 32-Bit Accelerometer Data Format Examples

Acceleration	Decimal	Hex
+78.3 m/sec ²	+2,097,152,000	0x7D000000
+4.9/2 ¹⁵ mm/sec ²	+2	0x00000002
+2.45/2 ¹⁶ mm/sec ²	+1	0x00000001
0	0	0x00000000
-2.45/2 ¹⁶ mm/sec ²	-1	0xFFFFFFFF
-4.9/2 ¹⁵ mm/sec ²	-2	0xFFFFFFFFE
-78.3 m/sec ²	-2,097,152,000	0x83000000

X-Axis Accelerometer (X_ACCL_LOW and X_ACCL_OUT)

Table 29. X_ACCL_LOW Register Definition

Addresses	Default	Access	Flash Backup
0x10, 0x11	Not applicable	R	No

Table 30. X_ACCL_LOW Bit Definitions

Bits	Description
[15:0]	X-axis accelerometer data; additional resolution bits

Table 31. X_ACCL_OUT Register Definition

Addresses	Default	Access	Flash Backup
0x12, 0x13	Not applicable	R	No

Table 32. X_ACCL_OUT Bit Definitions

Bits	Description
[15:0]	X-axis accelerometer data, high word; twos complement, $\pm 78.3 \text{ m/sec}^2$ range; $0 \text{ m/sec}^2 = 0x0000$, 1 LSB = 2.45 mm/sec^2

The X_ACCL_LOW (see Table 29 and Table 30) and X_ACCL_OUT (see Table 31 and Table 32) registers contain the accelerometer data for the x-axis.

Y-Axis Accelerometer (Y_ACCL_LOW and Y_ACCL_OUT)

Table 33. Y_ACCL_LOW Register Definition

Addresses	Default	Access	Flash Backup
0x14, 0x15	Not applicable	R	No

Table 34. Y_ACCL_LOW Bit Definitions

Bits	Description
[15:0]	Y-axis accelerometer data; additional resolution bits

Table 35. Y_ACCL_OUT Register Definition

Addresses	Default	Access	Flash Backup
0x16, 0x17	Not applicable	R	No

Table 36. Y_ACCL_OUT Bit Definitions

Bits	Description
[15:0]	Y-axis accelerometer data, high word; twos complement, $\pm 78.3 \text{ m/sec}^2$ range; $0 \text{ m/sec}^2 = 0x0000$, 1 LSB = 2.45 mm/sec^2

The Y_ACCL_LOW (see Table 33 and Table 34) and Y_ACCL_OUT (see Table 35 and Table 36) registers contain the accelerometer data for the y-axis.

Z-Axis Accelerometer (Z_ACCL_LOW and Z_ACCL_OUT)**Table 37. Z_ACCL_LOW Register Definition**

Addresses	Default	Access	Flash Backup
0x18, 0x19	Not applicable	R	No

Table 38. Z_ACCL_LOW Bit Definitions

Bits	Description
[15:0]	Z-axis accelerometer data; additional resolution bits

Table 39. Z_ACCL_OUT Register Definition

Addresses	Default	Access	Flash Backup
0x1A, 0x1B	Not applicable	R	No

Table 40. Z_ACCL_OUT Bit Definitions

Bits	Description
[15:0]	Z-axis accelerometer data, high word; twos complement, $\pm 78.3 \text{ m/sec}^2$ range; $0 \text{ m/sec}^2 = 0x0000$, 1 LSB = 2.45 mm/sec^2

The Z_ACCL_LOW (see Table 37 and Table 38) and Z_ACCL_OUT (see Table 39 and Table 40) registers contain the accelerometer data for the z-axis.

Internal Temperature (TEMP_OUT)**Table 41. TEMP_OUT Register Definition**

Addresses	Default	Access	Flash Backup
0x1C, 0x1D	Not applicable	R	No

Table 42. TEMP_OUT Bit Definitions

Bits	Description
[15:0]	Temperature data; twos complement, 1 LSB = 0.1°C , $0^\circ\text{C} = 0x0000$

The TEMP_OUT register (see Table 41 and Table 42) provides a coarse measurement of the temperature inside of the ADIS16505. This data is most useful for monitoring relative changes in the thermal environment.

Table 43. TEMP_OUT Data Format Examples

Temperature ($^\circ\text{C}$)	Decimal	Hex	Binary
+105	+1050	0x041A	0000 0100 0001 1010
+25	+250	0x00FA	0000 0000 1111 1010
+0.2	+2	0x0002	0000 0000 0000 0010
+0.1	+1	0x0001	0000 0000 0000 0001
+0	0	0x0000	0000 0000 0000 0000
+0.1	-1	0xFFFF	1111 1111 1111 1111
+0.2	-2	0xFFFE	1111 1111 1111 1110
-40	-400	0xFE70	1111 1110 0111 0000

Time Stamp (TIME_STAMP)**Table 44. TIME_STAMP Register Definition**

Addresses	Default	Access	Flash Backup
0x1E, 0x1F	Not applicable	R	No

Table 45. TIME_STAMP Bit Definitions

Bits	Description
[15:0]	Time from the last pulse on the SYNC pin; offset binary format, 1 LSB = $49.02 \mu\text{s}$

The TIME_STAMP register (see Table 44 and Table 45) works in conjunction with scaled sync mode (Register MSC_CTRL, Bits[3:2] = 10, see Table 106). The 16-bit number in TIME_STAMP contains the time associated with the last sample in each data update relative to the most recent edge of the clock signal in the SYNC pin. For example, when the value in the UP_SCALE register (see Table 108) represents a scale factor of 20, DEC_RATE = 0, and the external SYNC rate = 100 Hz, the following time stamp sequence results: 0 LSB, 10 LSB, 20 LSB, 30 LSB, 40 LSB, 50 LSB, 61 LSB, 71 LSB, ... , 193 LSB for the 20th sample, which translates to $0 \mu\text{s}$, $490 \mu\text{s}$, ... , $9460 \mu\text{s}$, the time from the first SYNC edge.

Data Update Counter (DATA_CNTR)**Table 46. DATA_CNTR Register Definition**

Addresses	Default	Access	Flash Backup
0x22, 0x23	Not applicable	R	No

Table 47. DATA_CNTR Bit Definitions

Bits	Description
[15:0]	Data update counter, offset binary format

When the ADIS16505 goes through its power-on sequence or when it recovers from a reset command, DATA_CNTR (see Table 46 and Table 47) starts with a value of 0x0000 and increments every time new data loads into the output registers. When the DATA_CNTR value reaches 0xFFFF, the next data update causes it to wrap back around to 0x0000 where it continues to increment every time new data loads into the output registers.

DELTA ANGLES

In addition to the angular rate of rotation (gyroscope) measurements around each axis (x, y, and z), the ADIS16505 also provides delta angle measurements that represent a calculation of angular displacement between each sample update.

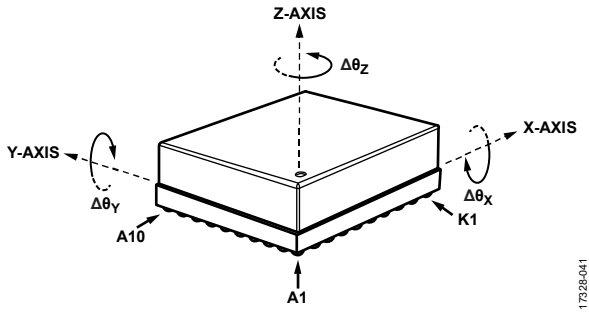

Figure 52. Delta Angle Axis and Polarity Assignments

The delta angle outputs represent an integration of the gyroscope measurements and use the following formula for all three axes (x-axis displayed):

$$\Delta\theta_{x,nD} = \frac{1}{2 \times f_s} \times \sum_{d=0}^{D-1} (\omega_{x,nD+d} + \omega_{x,nD+d-1})$$

where:

D is the decimation rate (DEC_RATE + 1, see Table 110).

f_s is the sample rate.

d is the incremental variable in the summation formula.

ω_x is the x-axis rate of rotation (gyroscope).

n is the sample time, prior to the decimation filter.

When using the internal sample clock, f_s is equal to a nominal rate of 2000 SPS. For better precision in this measurement, measure the internal sample rate (f_s) using the data ready signal on the DR pin (DEC_RATE = 0x0000, see Table 109), divide each delta angle result (from the delta angle output registers) by the data ready frequency, and multiply it by 2000. Each axis of the delta angle measurements has two output data registers. Figure 53 shows how these two registers combine to support a 32-bit, twos complement data format for the x-axis delta angle measurements. This format also applies to the y- and z-axes.

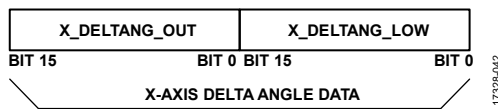

Figure 53. Delta Angle Output Data Structure

Delta Angle Measurement Range

Table 48 shows the measurement range and scale factor for each ADIS16505 model.

Table 48. Delta Angle Measurement Range and Scale Factor

Model	Measurement Range, $\pm\Delta\theta_{MAX}$ (°)
ADIS16505-1BMLZ	± 360
ADIS16505-2BMLZ	± 720
ADIS16505-3BMLZ	± 2160

X-Axis Delta Angle (X_DELTANG_LOW and X_DELTANG_OUT)

Table 49. X_DELTANG_LOW Register Definitions

Addresses	Default	Access	Flash Backup
0x24, 0x25	Not applicable	R	No

Table 50. X_DELTANG_LOW Bit Definitions

Bits	Description
[15:0]	X-axis delta angle data; low word

Table 51. X_DELTANG_OUT Register Definitions

Addresses	Default	Access	Flash Backup
0x26, 0x27	Not applicable	R	No

Table 52. X_DELTANG_OUT Bit Definitions

Bits	Description
[15:0]	X-axis delta angle data; twos complement, $0^\circ = 0x0000$, 1 LSB = $\Delta\theta_{MAX}/2^{15}$ (see Table 48 for $\pm\Delta\theta_{MAX}$)

The X_DELTANG_LOW (see Table 49 and Table 50) and X_DELTANG_OUT (see Table 51 and Table 52) registers contain the delta angle data for the x-axis.

Y-Axis Delta Angle (Y_DELTANG_LOW and Y_DELTANG_OUT)

Table 53. Y_DELTANG_LOW Register Definitions

Addresses	Default	Access	Flash Backup
0x28, 0x29	Not applicable	R	No

Table 54. Y_DELTANG_LOW Bit Definitions

Bits	Description
[15:0]	Y-axis delta angle data; low word

Table 55. Y_DELTANG_OUT Register Definitions

Addresses	Default	Access	Flash Backup
0x2A, 0x2B	Not applicable	R	No

Table 56. Y_DELTANG_OUT Bit Definitions

Bits	Description
[15:0]	Y-axis delta angle data; twos complement, $0^\circ = 0x0000$, 1 LSB = $\Delta\theta_{MAX}/2^{15}$ (see Table 48 for $\pm\Delta\theta_{MAX}$)

The Y_DELTANG_LOW (see Table 53 and Table 54) and Y_DELTANG_OUT (see Table 55 and Table 56) registers contain the delta angle data for the y-axis.

Z-Axis Delta Angle (Z_DELTANG_LOW and Z_DELTANG_OUT)

Table 57. Z_DELTANG_LOW Register Definitions

Addresses	Default	Access	Flash Backup
0x2C, 0x2D	Not applicable	R	No

Table 58. Z_DELTANG_LOW Bit Definitions

Bits	Description
[15:0]	Z-axis delta angle data; low word

Table 59. Z_DELTANG_OUT Register Definitions

Addresses	Default	Access	Flash Backup
0x2E, 0x2F	Not applicable	R	No

Table 60. Z_DELTANG_OUT Bit Definitions

Bits	Description
[15:0]	Z-axis delta angle data; twos complement, 0° = 0x0000, 1 LSB = $\Delta\theta_{MAX}/2^{15}$ (see Table 48 for $\pm\Delta\theta_{MAX}$)

The Z_DELTANG_LOW (see Table 57 and Table 58) and Z_DELTANG_OUT (see Table 59 and Table 60) registers contain the delta angle data for the z-axis.

Delta Angle Resolution

Table 61 and Table 62 show various numerical examples that demonstrate the format of the delta angle data in both 16-bit and 32-bit formats.

Table 61. 16-Bit Delta Angle Data Format Examples

Delta Angle (°)	Decimal	Hex	Binary
$\Delta\theta_{MAX} \times (2^{15}-1)/2^{15}$	+32,767	0x7FFF	0111 1111 1110 1111
$+\Delta\theta_{MAX}/2^{14}$	+2	0x0002	0000 0000 0000 0010
$+\Delta\theta_{MAX}/2^{15}$	+1	0x0001	0000 0000 0000 0001
0	0	0x0000	0000 0000 0000 0000
$-\Delta\theta_{MAX}/2^{15}$	-1	0xFFFF	1111 1111 1111 1111
$-\Delta\theta_{MAX}/2^{14}$	-2	0xFFFE	1111 1111 1111 1110
$-\Delta\theta_{MAX}$	-32,768	0x8000	1000 0000 0000 0000

Table 62. 32-Bit Delta Angle Data Format Examples

Delta Angle (°)	Decimal	Hex
$+\Delta\theta_{MAX} \times (2^{31}-1)/2^{31}$	+2,147,483,647	0x7FFFFFFF
$+\Delta\theta_{MAX}/2^{30}$	+2	0x00000002
$+\Delta\theta_{MAX}/2^{31}$	+1	0x00000001
0	0	0x00000000
$-\Delta\theta_{MAX}/2^{31}$	-1	0xFFFFFFFF
$-\Delta\theta_{MAX}/2^{30}$	-2	0xFFFFFFFFE
$-\Delta\theta_{MAX}$	-2,147,483,648	0x80000000

DELTA VELOCITY

In addition to the linear acceleration measurements along each axis (x, y, and z), the ADIS16505 also provides delta velocity measurements that represent a calculation of linear velocity change between each sample update.

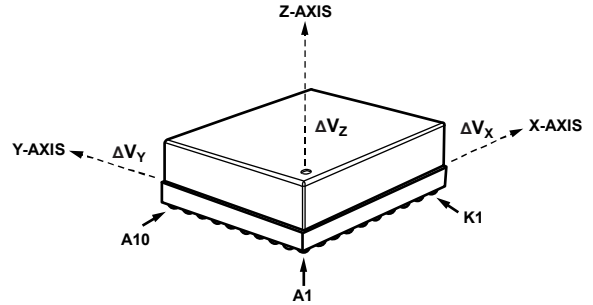

Figure 54. Delta Velocity Axis and Polarity Assignments

The delta velocity outputs represent an integration of the acceleration measurements and use the following formula for all three axes (x-axis displayed):

$$\Delta V_{x,nD} = \frac{1}{2 \times f_s} \times \sum_{d=0}^{D-1} (a_{x,nD+d} + a_{x,nD+d-1})$$

where:

x is the x-axis.

n is the sample time, prior to the decimation filter.

D is the decimation rate (DEC_RATE + 1, see Table 110).

f_s is the sample rate.

d is the incremental variable in the summation formula.

a_x is the x-axis acceleration.

When using the internal sample clock, f_s is equal to a nominal rate of 2000 SPS. For better precision in this measurement, measure the internal sample rate (f_s) using the data ready signal on the DR pin (DEC_RATE = 0x0000, see Table 109), divide each delta angle result (from the delta angle output registers) by the data ready frequency, and multiply it by 2000. Each axis of the delta velocity measurements has two output data registers. Figure 55 shows how these two registers combine to support 32-bit, twos complement data format for the delta velocity measurements along the x-axis. This format also applies to the y- and z-axes.

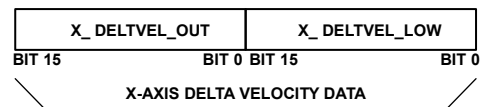

Figure 55. Delta Velocity Output Data Structure

X-Axis Delta Velocity (X_DELTVEL_LOW and X_DELTVEL_OUT)

Table 63. X_DELTVEL_LOW Register Definition

Addresses	Default	Access	Flash Backup
0x30, 0x31	Not applicable	R	No

Table 64. X_DELTVEL_LOW Bit Definitions

Bits	Description
[15:0]	X-axis delta velocity data; additional resolution bits

Table 65. X_DELTVEL_OUT Register Definition

Addresses	Default	Access	Flash Backup
0x32, 0x33	Not applicable	R	No

Table 66. X_DELTVEL_OUT Bit Definitions

Bits	Description
[15:0]	X-axis delta velocity data; twos complement, ± 100 m/sec range, 0 m/sec = 0x0000; 1 LSB = $+100 \text{ m/sec} \div 2^{15} = \sim +0.003052 \text{ m/sec}$

The X_DELTVEL_LOW (see Table 63 and Table 64) and X_DELTVEL_OUT (see Table 65 and Table 66) registers contain the delta velocity data for the x-axis.

Y-Axis Delta Velocity (Y_DELTVEL_LOW and Y_DELTVEL_OUT)

Table 67. Y_DELTVEL_LOW Register Definition

Addresses	Default	Access	Flash Backup
0x34, 0x35	Not applicable	R	No

Table 68. Y_DELTVEL_LOW Bit Definitions

Bits	Description
[15:0]	Y-axis delta velocity data; additional resolution bits

Table 69. Y_DELTVEL_OUT Register Definition

Addresses	Default	Access	Flash Backup
0x36, 0x37	Not applicable	R	No

Table 70. Y_DELTVEL_OUT Bit Definitions

Bits	Description
[15:0]	Y-axis delta velocity data; twos complement, ± 100 m/sec range, 0 m/sec = 0x0000; 1 LSB = $+100 \text{ m/sec} \div 2^{15} = \sim +0.003052 \text{ m/sec}$

The Y_DELTVEL_LOW (see Table 67 and Table 68) and Y_DELTVEL_OUT (see Table 69 and Table 70) registers contain the delta velocity data for the y-axis.

Z-Axis Delta Velocity (Z_DELTVEL_LOW and Z_DELTVEL_OUT)

Table 71. Z_DELTVEL_LOW Register Definition

Addresses	Default	Access	Flash Backup
0x38, 0x39	Not applicable	R	No

Table 72. Z_DELTVEL_LOW Bit Definitions

Bits	Description
[15:0]	Z-axis delta velocity data; additional resolution bits

Table 73. Z_DELTVEL_OUT Register Definition

Addresses	Default	Access	Flash Backup
0x3A, 0x3B	Not applicable	R	No

Table 74. Z_DELTVEL_OUT Bit Definitions

Bits	Description
[15:0]	Z-axis delta velocity data; twos complement, ± 100 m/sec range, 0 m/sec = 0x0000; 1 LSB = $+100 \text{ m/sec} \div 2^{15} = \sim +0.003052 \text{ m/sec}$

The Z_DELTVEL_LOW (see Table 71 and Table 72) and Z_DELTVEL_OUT (see Table 73 and Table 74) registers contain the delta velocity data for the z-axis.

Delta Velocity Resolution

Table 75 and Table 76 offer various numerical examples that demonstrate the format of the delta velocity data in both 16-bit and 32-bit formats.

Table 75. 16-Bit Delta Velocity Data Format Examples

Velocity (m/sec)	Decimal	Hex	Binary
$+100 \times (2^{15} - 1)/2^{15}$	+32,767	0x7FFF	0111 1111 1111 1111
$+100/2^{14}$	+2	0x0002	0000 0000 0000 0010
$+100/2^{15}$	+1	0x0001	0000 0000 0000 0001
0	0	0x0000	0000 0000 0000 0000
$-100/2^{15}$	-1	0xFFFF	1111 1111 1111 1111
$-100/2^{14}$	-2	0xFFFE	1111 1111 1111 1110
-100	-32,768	0x8000	1000 0000 0000 0000

Table 76. 32-Bit Delta Velocity Data Format Examples

Velocity (m/sec)	Decimal	Hex
$+100 \times (2^{31} - 1)/2^{31}$	+2,147,483,647	0x7FFFFFFF
$+100/2^{30}$	+2	0x00000002
$+100/2^{31}$	+1	0x00000001
0	0	0x00000000
$-100/2^{31}$	-1	0xFFFFFFFF
$-100/2^{30}$	-2	0xFFFFFFFF
-100	+2,147,483,648	0x80000000

CALIBRATION

The signal chain of each inertial sensor (accelerometers and gyroscopes) includes the application of unique correction formulas, which are derived from extensive characterization of bias, sensitivity, alignment, response to linear acceleration (gyroscopes), and point of percussion (accelerometer location) over a temperature range of -40°C to +85°C, for each ADIS16505. These correction formulas are not accessible, but users do have the opportunity to adjust the bias for each sensor individually through user accessible registers. These correction factors follow immediately after the factory derived correction formulas in the signal chain, which processes at a rate of 2000 Hz when using the internal sample clock.

Calibration, Gyroscope Bias (XG_BIAS_LOW and XG_BIAS_HIGH)

Table 77. XG_BIAS_LOW Register Definition

Addresses	Default	Access	Flash Backup
0x40, 0x41	0x0000	R/W	Yes

Table 78. XG_BIAS_LOW Bit Definitions

Bits	Description
[15:0]	X-axis gyroscope offset correction; lower word

Table 79. XG_BIAS_HIGH Register Definition

Addresses	Default	Access	Flash Backup
0x42, 0x43	0x0000	R/W	Yes

Table 80. XG_BIAS_HIGH Bit Definitions

Bits	Description
[15:0]	X-axis gyroscope offset correction factor, upper word

The XG_BIAS_LOW (see Table 77 and Table 78) and XG_BIAS_HIGH (see Table 79 and Table 80) registers combine to allow users to adjust the bias of the x-axis gyroscopes. The data format examples in Table 13 also apply to the XG_BIAS_HIGH register, and the data format examples in Table 14 apply to the 32-bit combination of the XG_BIAS_LOW and XG_BIAS_HIGH registers. See Figure 56 for an illustration of how these two registers combine and influence the x-axis gyroscope measurements.

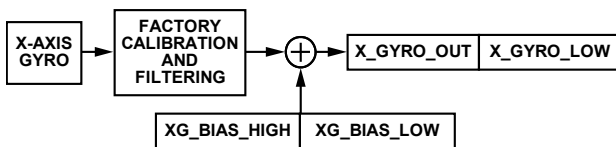

Figure 56. User Calibration Signal Path, Gyroscopes

1732B-045

Calibration, Gyroscope Bias (YG_BIAS_LOW and YG_BIAS_HIGH)

Table 81. YG_BIAS_LOW Register Definition

Addresses	Default	Access	Flash Backup
0x44, 0x45	0x0000	R/W	Yes

Table 82. YG_BIAS_LOW Bit Definitions

Bits	Description
[15:0]	Y-axis gyroscope offset correction; lower word

Table 83. YG_BIAS_HIGH Register Definition

Addresses	Default	Access	Flash Backup
0x46, 0x47	0x0000	R/W	Yes

Table 84. YG_BIAS_HIGH Bit Definitions

Bits	Description
[15:0]	Y-axis gyroscope offset correction factor, upper word

The YG_BIAS_LOW (see Table 81 and Table 82) and YG_BIAS_HIGH (see Table 83 and Table 84) registers combine to allow users to adjust the bias of the y-axis gyroscopes. The data format examples in Table 13 also apply to the YG_BIAS_HIGH register, and the data format examples in Table 14 apply to the 32-bit combination of the YG_BIAS_LOW and YG_BIAS_HIGH registers. These registers influence the y-axis gyroscope measurements in the same manner that the XG_BIAS_LOW and XG_BIAS_HIGH registers influence the x-axis gyroscope measurements (see Figure 56).

Calibration, Gyroscope Bias (ZG_BIAS_LOW and ZG_BIAS_HIGH)

Table 85. ZG_BIAS_LOW Register Definition

Addresses	Default	Access	Flash Backup
0x48, 0x49	0x0000	R/W	Yes

Table 86. ZG_BIAS_LOW Bit Definitions

Bits	Description
[15:0]	Z-axis gyroscope offset correction; lower word

Table 87. ZG_BIAS_HIGH Register Definition

Addresses	Default	Access	Flash Backup
0x4A, 0x4B	0x0000	R/W	Yes

Table 88. ZG_BIAS_HIGH Bit Definitions

Bits	Description
[15:0]	Z-axis gyroscope offset correction factor, upper word

The ZG_BIAS_LOW (see Table 85 and Table 86) and ZG_BIAS_HIGH (see Table 87 and Table 88) registers combine to allow users to adjust the bias of the z-axis gyroscopes. The data format examples in Table 13 also apply to the ZG_BIAS_HIGH register, and the data format examples in Table 14 apply to the 32-bit combination of the ZG_BIAS_LOW and ZG_BIAS_HIGH registers.

These registers influence the z-axis gyroscope measurements in the same manner that the XG_BIAS_LOW and XG_BIAS_HIGH registers influence the x-axis gyroscope measurements (see Figure 56).

Calibration, Accelerometer Bias (XA_BIAS_LOW and XA_BIAS_HIGH)

Table 89. XA_BIAS_LOW Register Definition

Addresses	Default	Access	Flash Backup
0x4C, 0x4D	0x0000	R/W	Yes

Table 90. XA_BIAS_LOW Bit Definitions

Bits	Description
[15:0]	X-axis accelerometer offset correction; lower word

Table 91. XA_BIAS_HIGH Register Definition

Addresses	Default	Access	Flash Backup
0x4E, 0x4F	0x0000	R/W	Yes

Table 92. XA_BIAS_HIGH Bit Definitions

Bits	Description
[15:0]	X-axis accelerometer offset correction, upper word

The XA_BIAS_LOW (see Table 89 and Table 90) and XA_BIAS_HIGH (see Table 91 and Table 92) registers combine to allow users to adjust the bias of the x-axis accelerometers. The data format examples in Table 27 also apply to the XA_BIAS_HIGH register and the data format examples in Table 28 apply to the 32-bit combination of the XA_BIAS_LOW and XA_BIAS_HIGH registers. See Figure 57 for an illustration of how these two registers combine and influence the x-axis accelerometer measurements.

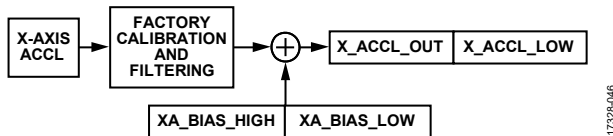

Figure 57. User Calibration Signal Path, Accelerometers

Calibration, Accelerometer Bias (YA_BIAS_LOW and YA_BIAS_HIGH)

Table 93. YA_BIAS_LOW Register Definition

Addresses	Default	Access	Flash Backup
0x50, 0x51	0x0000	R/W	Yes

Table 94. YA_BIAS_LOW Bit Definitions

Bits	Description
[15:0]	Y-axis accelerometer offset correction; lower word

Table 95. YA_BIAS_HIGH Register Definition

Addresses	Default	Access	Flash Backup
0x52, 0x53	0x0000	R/W	Yes

Table 96. YA_BIAS_HIGH Bit Definitions

Bits	Description
[15:0]	Y-axis accelerometer offset correction, upper word

The YA_BIAS_LOW (see Table 93 and Table 94) and YA_BIAS_HIGH (see Table 95 and Table 96) registers combine to allow users to adjust the bias of the y-axis accelerometers. The data format examples in Table 27 also apply to the YA_BIAS_HIGH register, and the data format examples in Table 28 apply to the 32-bit combination of the YA_BIAS_LOW and YA_BIAS_HIGH registers. These registers influence the y-axis accelerometer measurements in the same manner that the XA_BIAS_LOW and XA_BIAS_HIGH registers influence the x-axis accelerometer measurements (see Figure 57).

Calibration, Accelerometer Bias (ZA_BIAS_LOW and ZA_BIAS_HIGH)

Table 97. ZA_BIAS_LOW Register Definition

Addresses	Default	Access	Flash Backup
0x54, 0x55	0x0000	R/W	Yes

Table 98. ZA_BIAS_LOW Bit Definitions

Bits	Description
[15:0]	Z-axis accelerometer offset correction; lower word

Table 99. ZA_BIAS_HIGH Register Definition

Addresses	Default	Access	Flash Backup
0x56, 0x57	0x0000	R/W	Yes

Table 100. ZA_BIAS_HIGH Bit Definitions

Bits	Description
[15:0]	Z-axis accelerometer offset correction, upper word

The ZA_BIAS_LOW (see Table 97 and Table 98) and ZA_BIAS_HIGH (see Table 99 and Table 100) registers combine to allow users to adjust the bias of the z-axis accelerometers. The data format examples in Table 27 also apply to the ZA_BIAS_HIGH register and the data format examples in Table 28 apply to the 32-bit combination of the ZA_BIAS_LOW and ZA_BIAS_HIGH registers. These registers influence the z-axis accelerometer measurements in the same manner that the XA_BIAS_LOW and XA_BIAS_HIGH registers influence the x-axis accelerometer measurements (see Figure 57).

Filter Control Register (FILT_CTRL)

Table 101. FILT_CTRL Register Definition

Addresses	Default	Access	Flash Backup
0x5C, 0x5D	0x0000	R/W	Yes

Table 102. FILT_CTRL Bit Definitions

Bits	Description
[15:3]	Not used
[2:0]	Filter Size Variable B; number of taps in each stage; $N = 2^B$, where $B = 0$ to 6 (decimal). Changes to this register may take up to 30 μ s after writing to indicate the new value during readback.

The FILT_CTRL register (see Table 101 and Table 102) provides user controls for the Bartlett window FIR filter (see Figure 31), which contains two cascaded averaging filters. For example, use the following sequence to set Register FILT_CTRL, Bits[2:0] = 0100, which sets each stage to have 16 taps: 0xCC04 and 0xCD00. Figure 58 provides the frequency response for several settings in the FILT_CTRL register.

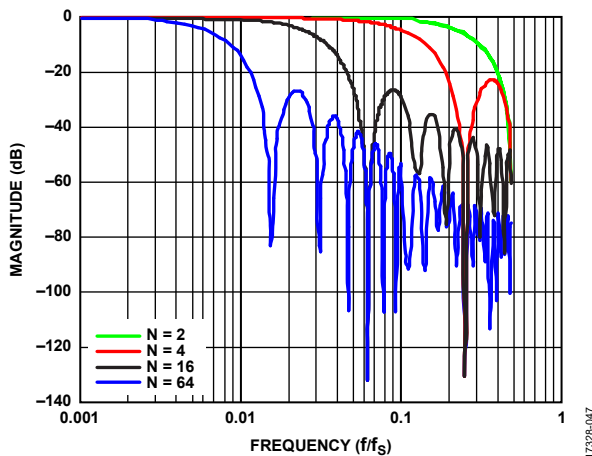

Figure 58. Bartlett Window, FIR Filter Frequency Response (Phase Delay = N Samples)

Range Identifier (RANG_MDL)

Table 103. RANG_MDL Register Definition

Addresses	Default	Access	Flash Backup
0x5E, 0x5F	Not applicable	R	No

Table 104. RANG_MDL Bit Definitions

Bits	Description
[15:3]	Not used
[3:2]	Gyroscope measurement range 00 = $\pm 125^\circ/\text{sec}$ (ADIS16505-1BMLZ) 01 = $\pm 500^\circ/\text{sec}$ (ADIS16505-2BMLZ) 10 = reserved 11 = $\pm 2000^\circ/\text{sec}$ (ADIS16505-3BMLZ)
[1:0]	Reserved, binary value = 11

Miscellaneous Control Register (MSC_CTRL)

Table 105. MSC_CTRL Register Definition

Addresses	Default	Access	Flash Backup
0x60, 0x61	0x00C1	R/W	Yes

Table 106. MSC_CTRL Bit Definitions

Bits	Description
[15:10]	Not used
9	BURST32. 32-bit burst enable bit. The user must wait until a full data ready cycle until the burst array updates with the desired data type. Changes to this bit may take up to 200 μ s after writing to indicate the new value during readback. 1 = 32-bit burst data. 0 = 16-bit burst data (default).
8	BURST_SEL. Burst read output array selection. This bit controls what calibrated data is in a burst read. Changes to this bit may take up to 200 μ s after writing to indicate the new value during readback. 1 = burst data has delta angle and delta velocity data. 0 = burst data has gyroscope and accelerometer data (default).
7	Linear acceleration compensation for gyroscopes. When enabled, factory calibrated linear acceleration compensation data is applied to the gyroscope outputs. Changes to this bit may take up to 200 μ s after writing to indicate the new value during readback. 1 = enabled. 0 = disabled (default).
6	Point of percussion alignment. When set, this bit allows for relocation of the acceleration sensors to a common point of percussion on the package corner by considering angular rotations. Changes to this bit may take up to 200 μ s after writing to indicate the new value during readback. 1 = enabled. 0 = disabled (default).
5	Not used. Always set to 0.
4	SENS_BW. Internal sensor bandwidth. Changing this bit reinitializes the sensors, and the user must wait until the DR pin starts toggling after changing this bit. This operation may require up to 250 ms to complete. 0 = wide bandwidth (default), see Table 1. 1 = 370 Hz. The gyroscope group delay increases by 0.17 ms and the accelerometer group delay increases by 0.63 ms in this mode.
[3:2]	SYNC mode select (see the Clock Control section for more information). The user must wait until the DR pin starts toggling after changing these bits and/or the UP_SCALE register in order to correctly read back the new values. However, the user can write these registers in succession before waiting for the DR pin to resume toggling. 00 = internal SYNC (default). Internal 2 kHz clock used. 01 = direct input sync mode. The user provides an external input clock between 1900 Hz and 2100 Hz. 10 = scaled sync mode. The user provides an external input clock between 1 Hz and 128 Hz, which upscales to 1900 Hz to 2100 Hz inside the ADIS16505.

Bits	Description
	11 = output sync mode. Identical to internal sync mode, except the SYNC pin functions as an output signal, indicating when the internal clock samples sensors.
1	SYNC polarity (input or output). Changes to this bit may take up to 200 μs after writing to indicate the new value during readback. 1 = rising edge triggers sampling. 0 = falling edge triggers sampling (default).
0	DR polarity. This bit controls the polarity of the DR pin. Changes to this bit may take up to 200 μs after writing to indicate the new value during readback. 1 = active high when data is valid. 0 = active low when data is valid (default).

Point of Percussion

Register MSC_CTRL, Bit 6 (see Table 106) offers an on/off control for the point of percussion alignment function, which maps the accelerometer sensors to the corner of the package that is closest to Pin A1 (see Figure 59). The factory default setting in the MSC_CTRL register activates this function. To turn this function off while retaining the rest of the factory default settings in the MSC_CTRL register, set Register MSC_CTRL, Bit 6 = 0 using the following command sequence on the DIN pin: 0xE081, then 0xE100.

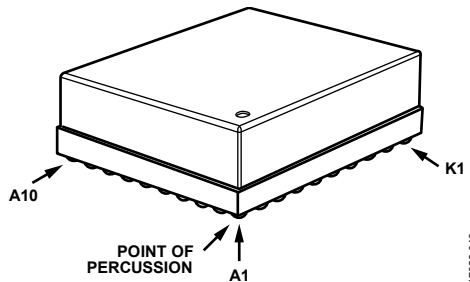

Figure 59. Point of Percussion Reference Point

Linear Acceleration Effect on Gyroscope Bias

Register MSC_CTRL, Bit 7 (see Table 106) provides an on/off control for the linear acceleration compensation in the signal calibration routines of the gyroscope. The factory default contents in the MSC_CTRL register enable this compensation. To turn the compensation off, set Register MSC_CTRL, Bit 7 = 0 using the following sequence on the DIN pin: 0xE041, 0xEF00.

Sync Mode Select

Refer to the Clock Control section for the functions of the sync mode select bits.

Sync Input Frequency Multiplier (UP_SCALE)

Table 107. UP_SCALE Register Definition

Addresses	Default	Access	Flash Backup
0x62, 0x63	0x07D0	R/W	Yes

Table 108. UP_SCALE Bit Definitions

Bits	Description
[15:0]	K_{ESCF} ; binary format. The user must wait until the DR pin starts toggling after changing this register and/or MSC_CTRL[3:2] to correctly read back the new values. However, the user can write these registers in succession before waiting for the DR pin to resume toggling.

Refer to the Clock Control section for the function and programming of the UP_SCALE register.

Decimation Filter (DEC_RATE)

Table 109. DEC_RATE Register Definition

Addresses	Default	Access	Flash Backup
0x64, 0x65	0x0000	R/W	Yes

Table 110. DEC_RATE Bit Definitions

Bits	Description
[15:11]	Don't care
[10:0]	Decimation rate, binary format, maximum = 1999. Changes to this register may take up to 30 μs after writing to indicate the new value during readback.

The DEC_RATE register (see Table 109 and Table 110) provides user control for the averaging decimating filter, which averages and decimates the gyroscope and accelerometer data; it also extends the time that the delta angle and the delta velocity track between each update. When the ADIS16505 operates in internal clock mode (see Register MSC_CTRL, Bits[3:2], in Table 106), the nominal output data rate is equal to $2000 / (DEC_RATE + 1)$. For example, set DEC_RATE = 0x0013 to reduce the output sample rate to 100 SPS ($2000 \div 20$) using the following DIN pin sequence: 0xE413, then 0xE500.

Data Update Rate in External Sync Modes

When using the input sync option in scaled sync mode (Register MSC_CTRL, Bits[3:2] = 10, see Table 106), the output data rate is equal to

$$(f_{SYNC} \times K_{ESCF}) / (DEC_RATE + 1)$$

where:

f_{SYNC} is the frequency of the clock signal on the SYNC pin.

K_{ESCF} is the value from the UP_SCALE register (see Table 108).

When using direct sync mode, $K_{ESCF} = 1$.

Global Commands (GLOB_CMD)**Table 111. GLOB_CMD Register Definition**

Addresses	Default	Access	Flash Backup
0x68, 0x69	Not applicable	W	No

Table 112. GLOB_CMD Bit Definitions

Bits	Description
[15:8]	Not used
7	Software reset
[6:5]	Not used
4	Flash memory test
3	Flash memory update
2	Sensor self test
1	Factory calibration restore
0	Not used

The GLOB_CMD register (see Table 111 and Table 112) provides trigger bits for several operations. Write a 1 to the appropriate bit in GLOB_CMD to start a particular function. During the execution of these commands, data production stops, pulsing stops on the DR pin, and the SPI interface does not respond to requests. Table 1 provides the execution time for each GLOB_CMD command.

Software Reset

Use the following DIN sequence to set Register GLOB_CMD, Bit 7 = 1, which triggers a reset: 0xE880, then 0xE900. This reset clears all data, and then restarts data sampling and processing. This function provides a firmware alternative to toggling the RST pin (see Table 5, Pin F3).

Flash Memory Test

Use the following DIN sequence to set Register GLOB_CMD, Bit 4 = 1, which tests the flash memory: 0xE810, then 0xE900. The command performs a CRC computation on the flash memory (excluding user register locations) and compares it to the original CRC value, which comes from the factory configuration process. If the current CRC value does not match the original CRC value, Register DIAG_STAT, Bit 6 (see Table 11), rises to 1, indicating a failing result.

Flash Memory Update

Use the following DIN sequence to set Register GLOB_CMD, Bit 3 = 1, which triggers a backup of all user configurable registers in the flash memory: 0xE808, then 0xE900. Register DIAG_STAT, Bit 2 (see Table 11), identifies success (0) or failure (1) in completing this process.

Sensor Self Test

Use the following DIN sequence to set Register GLOB_CMD, Bit 2 = 1, which triggers the self test routine for the inertial sensors: 0xE804, then 0xE900. The self test routine uses the following steps to validate the integrity of each inertial sensor:

1. Measure the output on each sensor.
2. Activate an internal stimulus on the mechanical elements of each sensor to move them in a predictable manner and create an observable response in the sensors.
3. Measure the output response on each sensor.
4. Deactivate the internal stimulus on each sensor.
5. Calculate the difference between the sensor measurements from Step 1 (stimulus is off) and from Step 4 (stimulus is on).
6. Compare the difference with internal pass and fail criteria.
7. Report the pass and fail result to Register DIAG_STAT, Bit 5 (see Table 11).

Motion during the execution of this test can indicate a false failure.

Factory Calibration Restore

Use the following DIN sequence to set Register GLOB_CMD, Bit 1 = 1, to restore the factory default settings for the MSC_CTRL, DEC_RATE, and FILT_CTRL registers and to clear all user configurable bias correction settings: 0xE802, then 0xE900. Executing this command results in writing 0x0000 to the following registers: XG_BIAS_LOW, XG_BIAS_HIGH, YG_BIAS_LOW, YG_BIAS_HIGH, ZG_BIAS_LOW, ZG_BIAS_HIGH, XA_BIAS_LOW, XA_BIAS_HIGH, YA_BIAS_LOW, YA_BIAS_HIGH, ZA_BIAS_LOW, and ZA_BIAS_HIGH.

Firmware Revision (FIRM_REV)**Table 113. FIRM_REV Register Definition**

Addresses	Default	Access	Flash Backup
0x6C, 0x6D	Not applicable	R	Yes

Table 114. FIRM_REV Bit Definitions

Bits	Description
[15:0]	Firmware revision, binary coded decimal (BCD) format

The FIRM_REV register (see Table 113 and Table 114) provides the firmware revision for the internal firmware. This register uses a BCD format where each nibble represents a digit. For example, if FIRM_REV = 0x0104, the firmware revision is 1.04.

Firmware Revision Day and Month (FIRM_DM)**Table 115. FIRM_DM Register Definition**

Addresses	Default	Access	Flash Backup
0x6E, 0x6F	Not applicable	R	Yes

Table 116. FIRM_DM Bit Definitions

Bits	Description
[15:8]	Factory configuration month, BCD format
[7:0]	Factory configuration day, BCD format

The FIRM_DM register (see Table 115 and Table 116) contains the month and day of the factory configuration date. Register FIRM_DM, Bits[15:8], contain digits that represent the month of the factory configuration. For example, November is the 11th month in a year and is represented by Register FIRM_DM, Bits[15:8] = 0x11. Register FIRM_DM, Bits[7:0], contain the day of factory configuration. For example, the 27th day of the month is represented by Register FIRM_DM, Bits[7:0] = 0x27.

Firmware Revision Year (FIRM_Y)**Table 117. FIRM_Y Register Definition**

Addresses	Default	Access	Flash Backup
0x70, 0x71	Not applicable	R	Yes

Table 118. FIRM_Y Bit Definitions

Bits	Description
[15:0]	Factory configuration year, BCD format

The FIRM_Y register (see Table 117 and Table 118) contains the year of the factory configuration date. For example, the year, 2017, is represented by FIRM_Y = 0x2017.

Product Identification (PROD_ID)**Table 119. PROD_ID Register Definition**

Addresses	Default	Access	Flash Backup
0x72, 0x73	0x4079	R	Yes

Table 120. PROD_ID Bit Definitions

Bits	Description
[15:0]	Product identification = 0x4079

The PROD_ID register (see Table 119 and Table 120) contains the numerical portion of the device number (16,505). See Figure 41 for an example of how to use a looping read of this register to validate the integrity of the communication.

Serial Number (SERIAL_NUM)**Table 121. SERIAL_NUM Register Definition**

Addresses	Default	Access	Flash Backup
0x74, 0x75	Not applicable	R	Yes

Table 122. SERIAL_NUM Bit Definitions

Bits	Description
[15:0]	Lot specific serial number

Scratch Registers (USER_SCR_1 to USER_SCR_3)**Table 123. USER_SCR_1 Register Definition**

Addresses	Default	Access	Flash Backup
0x76, 0x77	Not applicable	R/W	Yes

Table 124. USER_SCR_1 Bit Definitions

Bits	Description
[15:0]	User defined

Table 125. USER_SCR_2 Register Definition

Addresses	Default	Access	Flash Backup
0x78, 0x79	Not applicable	R/W	Yes

Table 126. USER_SCR_2 Bit Definitions

Bits	Description
[15:0]	User defined

Table 127. USER_SCR_3 Register Definition

Addresses	Default	Access	Flash Backup
0x7A, 0x7B	Not applicable	R/W	Yes

Table 128. USER_SCR_3 Bit Definitions

Bits	Description
[15:0]	User defined

The USER_SCR_1 (see Table 123 and Table 124), USER_SCR_2 (see Table 125 and Table 126), and USER_SCR_3 (see Table 127 and Table 128) registers provide three locations for the user to store information. For nonvolatile storage, use the manual flash memory update command (Register GLOB_CMD, Bit 3, see Table 112) after writing information to these registers.

Flash Memory Endurance Counter (FLSHCNT_LOW and FLSHCNT_HIGH)

Table 129. FLSHCNT_LOW Register Definition

Addresses	Default	Access	Flash Backup
0x7C, 0x7D	Not applicable	R	Yes

Table 130. FLSHCNT_LOW Bit Definitions

Bits	Description
[15:0]	Flash memory write counter, low word

Table 131. FLSHCNT_HIGH Register Definition

Addresses	Default	Access	Flash Backup
0x7E, 0x7F	Not applicable	R	Yes

Table 132. FLSHCNT_HIGH Bit Definitions

Bits	Description
[15:0]	Flash memory write counter, high word

The FLSHCNT_LOW (see Table 129 and Table 130) and FLSHCNT_HIGH (see Table 131 and Table 132) registers combine to provide a 32-bit, binary counter that tracks the number of flash memory write cycles. In addition to the number of write cycles, the flash memory has a finite service lifetime, which depends on the junction temperature. Figure 60 provides guidance for estimating the retention life for the flash memory at specific junction temperatures. The junction temperature is approximately 7°C above the case temperature.

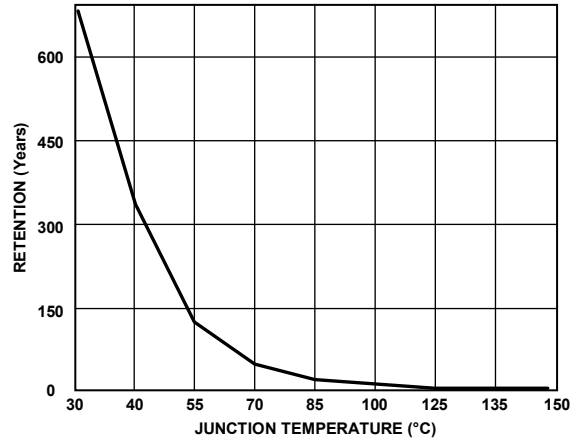

Figure 60. Flash Memory Retention

17328-050

APPLICATIONS INFORMATION

ASSEMBLY AND HANDLING TIPS

Package Attributes

The ADIS16505 is a multichip module package that has a 100-ball BGA interface. This package has three basic attributes that influence its handling and assembly to the PCB of the system: the lid, the substrate, and the BGA pattern. The material of the lid is a liquid crystal polymer (LCP), and its nominal thickness is 0.5 mm. The substrate is a laminate that has a nominal thickness of 1.57 mm. The solder ball material is SAC305, and each ball has a nominal diameter of 0.75 mm (± 0.15 mm). The BGA pattern is a 10×10 array.

All electrical and physical connections are through the 10×10 array shown in Figure 62. The bottom view in Figure 66 shows additional features from the manufacture of the ADIS16505 that are not relevant to the mounting or use of the ADIS16505.

Assembly Tips

When attaching the ADIS16505 to a PCB, follow these guidelines:

- The ADIS16505 supports solder reflow attachment processes in accordance with J-STD-020E.
- Limit device exposure to one pass through the solder reflow process (no rework).
- The hole in the top of the lid (see Figure 61) provides venting and pressure relief during the assembly process of the ADIS16505. This hole must be kept clear while attaching the ADIS16505 to a PCB. Although, covering the hole in normal operation is not typically a problem.

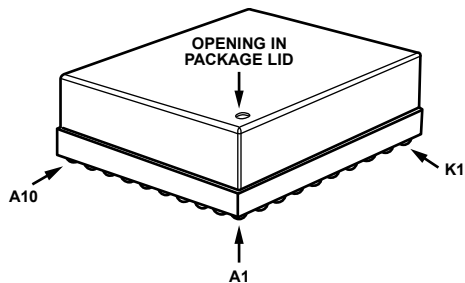

Figure 61. Pressure Relief Hole

- Use no clean flux and avoid exposing the device to cleaning solvents that can penetrate the inside of the ADIS16505 through multiple paths.
- Manage moisture exposure prior to the solder reflow processing in accordance with J-STD-033, Moisture Sensitivity Level 5.
- Avoid exposing the ADIS16505 to mechanical shock survivability that exceeds the maximum rating in Table 3. In standard PCB processing, high speed handling equipment and panel separation processes often present the most risk of introducing harmful levels of mechanical shock survivability.

PCB Layout Suggestions

Figure 62 shows an example of the pad design and layout for the ADIS16505 on a PCB. This example uses a solder mask opening with a diameter of 0.73 mm, around a metal pad that has a diameter of 0.56 mm. When using a material for the system PCB that has similar thermal expansion properties as the substrate material of the ADIS16505, the system PCB can also use the solder mask to define the pads that support attachment to the balls of the ADIS16505. The coefficient of thermal expansion (CTE) in the substrate of the ADIS16505 is approximately 14 ppm/°C.

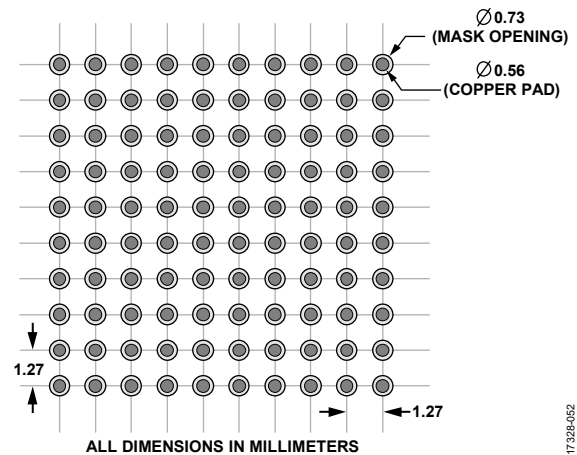

Figure 62. Recommend PCB Pattern, Solder Mask Defined Pads

Underfill

Underfill can be a useful technique in managing certain threats to the integrity of the solder joints of the ADIS16505, including peeling stress and extended exposure to vibration. When selecting underfill material and developing an application and curing process, ensure that the material fills the gap between each surface (the ADIS16505 substrate and system PCB) and adheres to both surfaces. The ADIS16505 does not require the use of underfill materials in applications that do not anticipate exposure to these types of mechanical stresses and when the CTE of the system PCB is close to the same value as the CTE of the substrate of the ADIS16505 (~ 14 ppm/°C).

Process Validation and Control

These guidelines provide a starting point for developing a process for attaching the ADIS16505 to a system PCB. Because each system and situation can present unique requirements for this attachment process, ensure that the process supports optimal solder joint integrity, verify that the final system meets all environmental test requirements, and establish observation and control strategies for all key process attributes (for example, peak temperatures, dwell times, and ramp rates).

POWER SUPPLY CONSIDERATIONS

The ADIS16505 contains 6 μF of decoupling capacitance across the VDD and GND pins. When the VDD voltage rises from 0 V to 3.3 V, the charging current for this capacitor bank imposes the following current profile (in amperes):

$$I_{DD}(t) = C \frac{dVDD}{dt} = 6 \times 10^{-6} \times \frac{dVDD(t)}{dt}$$

where:

$I_{DD}(t)$ is the current demand on the VDD pin during the initial power supply ramp, with respect to time.

C is the internal capacitance across the VDD and GND pins (6 μF).

$VDD(t)$ is the voltage on the VDD pin, with respect to time.

For example, if VDD follows a linear ramp from 0 V to 3.3 V, in 66 μs, the charging current is 300 mA for that timeframe. The ADIS16505 also contains embedded processing functions that present transient current demands during initialization or reset recovery operations. During these processes, the peak current demand reaches 250 mA and occurs at a time that is approximately 40 ms after VDD reaches 3.0 V (or ~40 ms after initiating a reset sequence).

EVALUATION TOOLS

Breakout Boards

The ADIS16505 has three difference breakout boards, which provide a simple way to connect an ADIS16505 model and an existing embedded processor platform. Table 133 provides a list of the model numbers for each breakout board, along with the ADIS16505 model that is on each breakout board. Figure 63 shows the ADIS16505-2 which is identical to the ADIS16505-1 and ADIS16505-3 boards.



Figure 63. ADIS16505-2 Breakout Board

Table 133. Breakout Board Models

Breakout Board Model	ADIS16505 Model
ADIS16505-1/PCBZ	ADIS16505-1BMLZ
ADIS16505-2/PCBZ	ADIS16505-2BMLZ
ADIS16505-3/PCBZ	ADIS16505-3BMLZ

The electrical interface (J1) on each breakout board comes from a dual row, 2 mm pitch, 16-pin interface, which supports standard ribbon cabling (1 mm pitch). Table 134 provides the J1 pin assignments, which support direct connection with an embedded processor board using standard ribbon cables. Although each case may present its own set of sensitivities (such as electromagnetic interference (EMI)), these boards can typically support reliable communication over ribbon cables up to 20 cm in length.

Table 134. J1 Pin Assignments, Breakout Board

J1 Pin Number	Signal	Function
1	RST	Reset
2	SCLK	SPI
3	CS	SPI
4	DOUT	SPI
5	NC	No connect
6	DIN	SPI
7	GND	Ground
8	GND	Ground
9	GND	Ground
10	VDD	Power, 3.3 V
11	VDD	Power, 3.3 V
12	VDD	Power, 3.3 V
13	DR	Data ready
14	SYNC	Input clock
15	NC	No connect
16	NC	No connect

Figure 64 provides a top view of the breakout board, including dimensional locations for all the key mechanical features, such as the mounting holes and the 16-pin header. Figure 65 provides an electrical schematic for this breakout board. For additional information, refer to the [ADIS1650x-x/PCBZ Breakout Board Wiki Guide](#).

PC-Based Evaluation, EVAL-ADIS2

In addition to supporting quick prototype connections between the ADIS16505 and an embedded processing system, J1 on the breakout boards also connects directly to J1 on the [EVAL-ADIS2](#) evaluation system. When used in conjunction with the [IMU Evaluation Software for the EVAL-ADISX Platforms](#), the [EVAL-ADIS2](#) provides a simple, functional test platform that allows users to configure and collect data from the ADIS16505 IMUs.

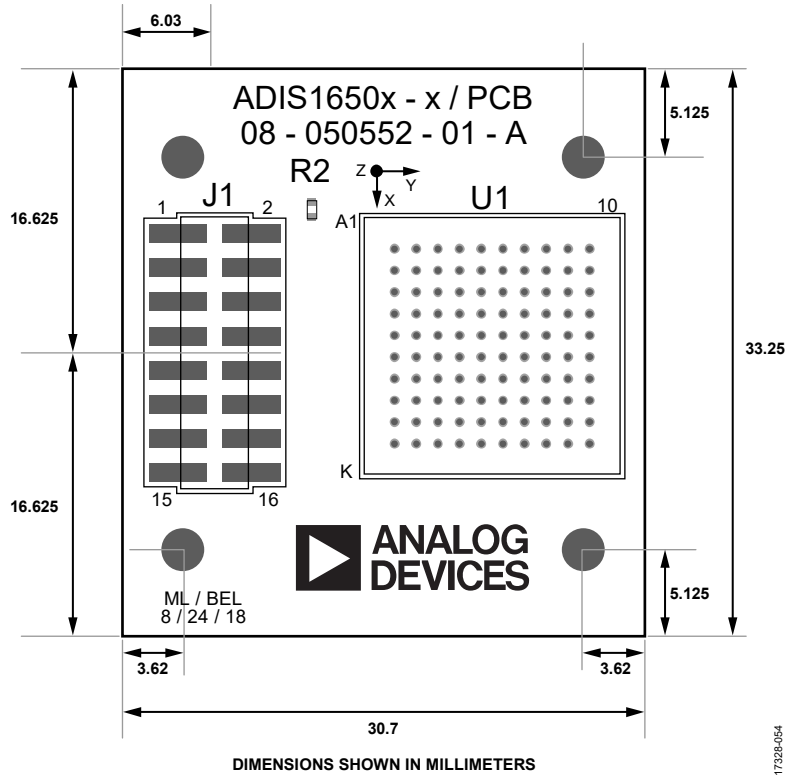

Figure 64. Top View of the ADIS16505 Breakout Board

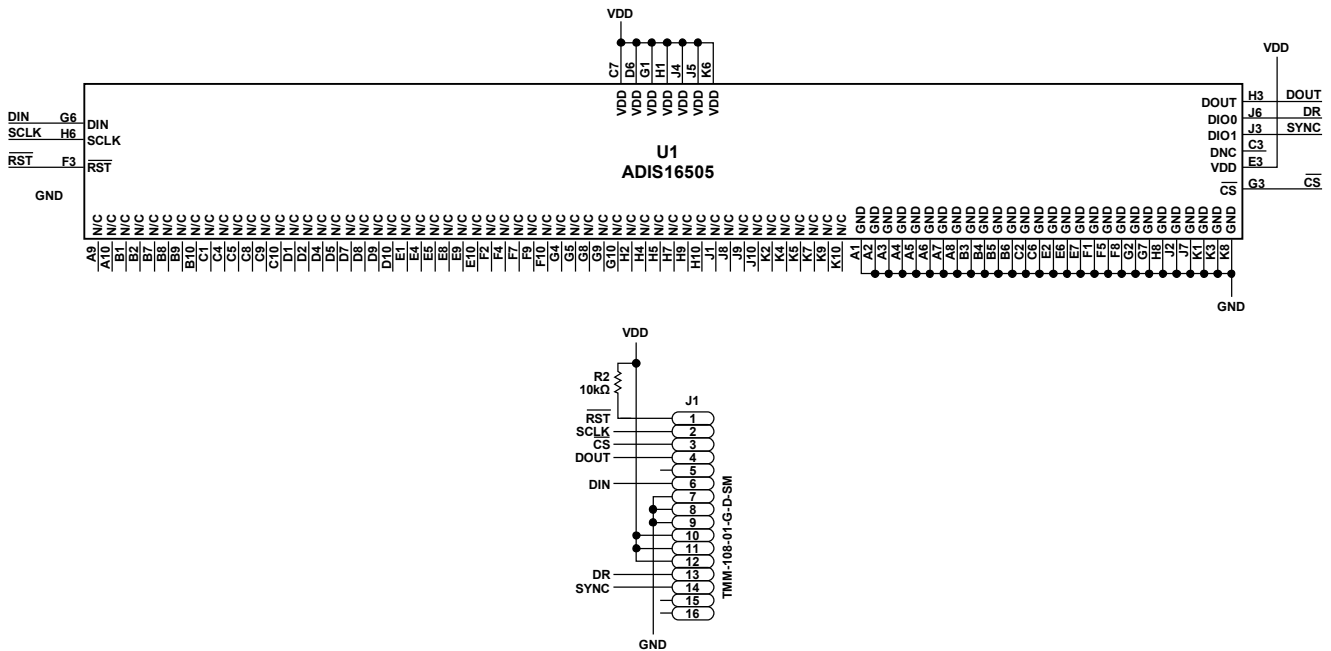

Figure 65. ADIS16505 Breakout Board Schematic

PACKAGING AND ORDERING INFORMATION
OUTLINE DIMENSIONS

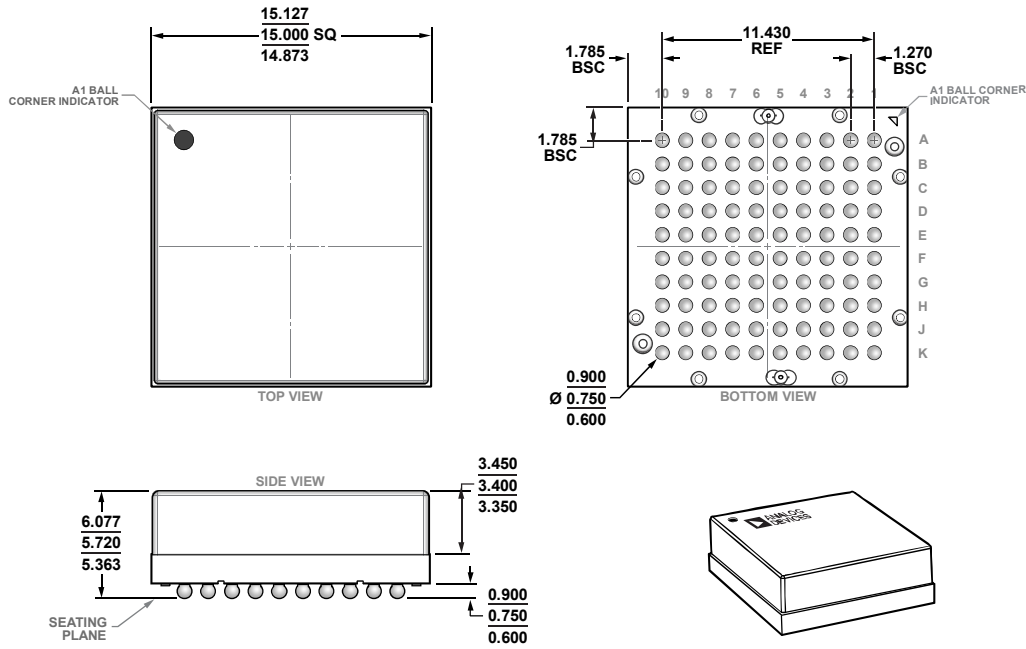

Figure 66. 100-Ball Ball Grid Array Module [BGA]
 (ML-100-1)
 Dimensions shown in millimeters

04-11-2016-A

ORDERING GUIDE

Model ¹	Temperature Range	Package Description	Package Option
ADIS16505-1BMLZ	-40°C to +105°C	100-Ball Ball Grid Array Module [BGA]	ML-100-1
ADIS16505-2BMLZ	-40°C to +105°C	100-Ball Ball Grid Array Module [BGA]	ML-100-1
ADIS16505-3BMLZ	-40°C to +105°C	100-Ball Ball Grid Array Module [BGA]	ML-100-1
ADIS16505-1/PCBZ		ADIS16505-1 Breakout Board	
ADIS16505-2/PCBZ		ADIS16505-2 Breakout Board	
ADIS16505-3/PCBZ		ADIS16505-3 Breakout Board	
EVAL-ADIS2Z		EVAL-ADIS2 Evaluation Board	

¹ Z = RoHS Compliant Part.

X-ON Electronics

Largest Supplier of Electrical and Electronic Components

Click to view similar products for IMUs - Inertial Measurement Units category:

Click to view products by Analog Devices manufacturer:

Other Similar products are found below :

[BMI055](#) [LSM303AGRTR](#) [IMU381ZA-200](#) [IMU383ZA-400](#) [4464](#) [4502](#) [4517](#) [ADIS16362BMLZ](#) [ADIS16364BMLZ](#) [ADIS16365BMLZ](#)
[ADIS16445BMLZ](#) [ADIS16465-1BMLZ](#) [ADIS16465-2BMLZ](#) [ADIS16467-1BMLZ](#) [ADIS16470AMLZ](#) [ADIS16475-3BMLZ](#) [ADIS16477-3BMLZ](#) [ADIS16495-2BMLZ](#) [ADIS16497-2BMLZ](#) [ADIS16505-3BMLZ](#) [ADIS16505-2BMLZ](#) [ADIS16507-2BMLZ](#) [ADIS16507-1/PCBZ](#)
[ADIS16507-2/PCBZ](#) [BMI160](#) [BMX055](#) [TARS-HCASS](#) [3DM-GX5-GNSS/INS](#) [LSM6DSLTR](#) [MPU-6050](#) [SCC2130-D08-05](#) [SCC2230-D08-05](#) [SCC2230-E02-05](#) [FMT1010T](#) [FMT1020T](#) [MTI-300-2A8G4](#) [MTI-200-2A8G4](#) [MTI-G-710-2A8G4](#) [LSM6DS3TR](#) [TARS-LCASS](#) [MTi-7-0I-T](#) [ADIS16334BMLZ](#) [ADIS16375BMLZ](#) [ADIS16477-2BMLZ](#) [ADIS16490BMLZ](#) [ADIS16489BMLZ-P](#) [MTi-30-2A8G4](#) [ADIS16475-2BMLZ](#) [ICM-30670](#) [SEN0373](#)