

**FEATURES**

**Fixed gain of 24.1 dB**  
**Broadband operation from 30 MHz to 6 GHz**  
**Input/output internally matched to 50  $\Omega$**   
**Integrated bias control circuit**  
**OIP3 of 36.4 dBm at 900 MHz**  
**P1dB of 18.1 dBm at 900 MHz**  
**Noise figure of 2.9 dB at 900 MHz**  
**Single 5 V power supply**  
**Low quiescent current of 56 mA**  
**Wide operating temperature range of  $-40^{\circ}\text{C}$  to  $+105^{\circ}\text{C}$**   
**Thermally efficient SOT-89 package**  
**ESD rating of  $\pm 1.5$  kV (Class 1C)**

**GENERAL DESCRIPTION**

The [ADL5545](#) is a single-ended RF/IF gain block amplifier that provides broadband operation from 30 MHz to 6 GHz. The [ADL5545](#) provides over 36 dBm of OIP3 using only 56 mA from a 5 V supply.

The [ADL5545](#) provides a gain of 24 dB, which is stable over frequency, temperature, power supply, and from device to device. The amplifier is offered in the industry-standard SOT-89 package and is internally matched to 50  $\Omega$  at the input and output, making the [ADL5545](#) very easy to implement in a wide variety of applications. The only external components required are the input/output ac coupling capacitors, power supply decoupling capacitors, and dc bias inductor.

**FUNCTIONAL BLOCK DIAGRAM**

Figure 1.

The [ADL5545](#) is fabricated on an InGaP HBT process and has a high ESD rating of  $\pm 1.5$  kV (Class 1C). The [ADL5545](#) is also fully specified for operation across the wide temperature range of  $-40^{\circ}\text{C}$  to  $+105^{\circ}\text{C}$ . A fully populated RoHS-compliant evaluation board is available.

## TABLE OF CONTENTS

Features .....	1	4 GHz to 6 GHz Frequency Band .....	9
Functional Block Diagram .....	1	General .....	10
General Description .....	1	Applications Information .....	12
Revision History .....	2	Basic Connections .....	12
Specifications .....	3	Soldering Information and Recommended PCB Land Pattern .....	13
Absolute Maximum Ratings .....	5	Operation Down to 30 MHz .....	14
Thermal Resistance .....	5	W-CDMA ACPR Performance .....	14
ESD Caution .....	5	Evaluation Board .....	15
Pin Configuration and Function Descriptions .....	6	Outline Dimensions .....	16
Typical Performance Characteristics .....	7	Ordering Guide .....	16
500 MHz to 4 GHz Frequency Band .....	7		
100 MHz to 500 MHz Frequency Band .....	8		

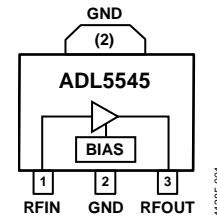
## REVISION HISTORY

### 5/2020—Rev. A to Rev. B

Deleted Typical Scattering Parameters (S-Parameters) Section and Table 2; Renumbered Sequentially..... 5

### 11/2013—Rev. 0 to Rev. A

Added Figure 25, Renumbered Sequentially..... 12  
 Changes to Figure 34 .....

Updated Outline Dimensions..... 18

### 4/2013—Revision 0: Initial Version

## SPECIFICATIONS

$V_{POS} = 5\text{ V}$  and  $T_A = 25^\circ\text{C}$ , unless otherwise noted.

Table 1.

Parameter	Test Conditions/Comments	Min	Typ	Max	Unit
OVERALL FUNCTION Frequency Range		30		6000	MHz
FREQUENCY = 30 MHz Gain Output 1 dB Compression Point Output Third-Order Intercept Noise Figure	$\Delta f = 1\text{ MHz}$ , output power ( $P_{OUT}$ ) = $-3\text{ dBm}$ per tone		22.6 12.0 30.3 3.8		dB dBm dBm dB
FREQUENCY = 140 MHz Gain vs. Frequency vs. Temperature vs. Supply Output 1 dB Compression Point Output Third-Order Intercept Noise Figure	$\pm 10\text{ MHz}$ $-40^\circ\text{C} \leq T_A \leq +85^\circ\text{C}$ 4.75 V to 5.25 V $\Delta f = 1\text{ MHz}$ , output power ( $P_{OUT}$ ) = $-3\text{ dBm}$ per tone		24.8 $\pm 0.03$ $\pm 0.6$ $\pm 0.30$ 14.6 31.5 3.1		dB dB dB dB dBm dBm dB
FREQUENCY = 350 MHz Gain vs. Frequency vs. Temperature vs. Supply Output 1 dB Compression Point Output Third-Order Intercept Noise Figure	$\pm 10\text{ MHz}$ $-40^\circ\text{C} \leq T_A \leq +85^\circ\text{C}$ 4.75 V to 5.25 V $\Delta f = 1\text{ MHz}$ , output power ( $P_{OUT}$ ) = $-3\text{ dBm}$ per tone		24.6 $\pm 0.01$ $\pm 0.6$ $\pm 0.30$ 16.1 32.6 3.3		dB dB dB dB dBm dBm dB
FREQUENCY = 700 MHz Gain vs. Frequency vs. Temperature vs. Supply Output 1 dB Compression Point Output Third-Order Intercept Noise Figure	$\pm 50\text{ MHz}$ $-40^\circ\text{C} \leq T_A \leq +85^\circ\text{C}$ 4.75 V to 5.25 V $\Delta f = 1\text{ MHz}$ , output power ( $P_{OUT}$ ) = $-3\text{ dBm}$ per tone	23.7	24.4 $\pm 0.05$ $\pm 0.5$ $\pm 0.13$ 17.9 38.8 3.0	25.1	dB dB dB dB dBm dBm dB
FREQUENCY = 900 MHz Gain vs. Frequency vs. Temperature vs. Supply Output 1 dB Compression Point Output Third-Order Intercept Noise Figure	$\pm 50\text{ MHz}$ $-40^\circ\text{C} \leq T_A \leq +85^\circ\text{C}$ 4.75 V to 5.25 V $\Delta f = 1\text{ MHz}$ , output power ( $P_{OUT}$ ) = $-3\text{ dBm}$ per tone	23.4	24.1 $\pm 0.07$ $\pm 0.5$ $\pm 0.13$ 18.1 36.4 2.9	24.8	dB dB dB dB dBm dBm dB
FREQUENCY = 1900 MHz Gain vs. Frequency vs. Temperature vs. Supply Output 1 dB Compression Point Output Third-Order Intercept Noise Figure	$\pm 50\text{ MHz}$ $-40^\circ\text{C} \leq T_A \leq +85^\circ\text{C}$ 4.75 V to 5.25 V $\Delta f = 1\text{ MHz}$ , output power ( $P_{OUT}$ ) = $-3\text{ dBm}$ per tone	21.5	22.2 $\pm 0.11$ $\pm 0.7$ $\pm 0.17$ 16.6 35.2 3.4	22.9	dB dB dB dB dBm dBm dB

Parameter	Test Conditions/Comments	Min	Typ	Max	Unit
FREQUENCY = 2140 MHz					
Gain		21.1	21.8	22.4	dB
vs. Frequency	±50 MHz		±0.09		dB
vs. Temperature	−40°C ≤ T <sub>A</sub> ≤ +85°C		±0.7		dB
vs. Supply	4.75 V to 5.25 V		±0.17		dB
Output 1 dB Compression Point			16.2		dBm
Output Third-Order Intercept	Δf = 1 MHz, output power (P <sub>OUT</sub> ) = −3 dBm per tone		35.7		dBm
Noise Figure			3.5		dB
FREQUENCY = 2600 MHz					
Gain		20.1	20.9	21.7	dB
vs. Frequency	±50 MHz		±0.09		dB
vs. Temperature	−40°C ≤ T <sub>A</sub> ≤ +85°C		±0.7		dB
vs. Supply	4.75 V to 5.25 V		±0.16		dB
Output 1 dB Compression Point			15.7		dBm
Output Third-Order Intercept	Δf = 1 MHz, output power (P <sub>OUT</sub> ) = −3 dBm per tone		34.6		dBm
Noise Figure			3.6		dB
FREQUENCY = 3500 MHz					
Gain		19.0	19.7	20.4	dB
vs. Frequency	±50 MHz		±0.10		dB
vs. Temperature	−40°C ≤ T <sub>A</sub> ≤ +85°C		±0.8		dB
vs. Supply	4.75 V to 5.25 V		±0.17		dB
Output 1 dB Compression Point			14.5		dBm
Output Third-Order Intercept	Δf = 1 MHz, output power (P <sub>OUT</sub> ) = −3 dBm per tone		33.7		dBm
Noise Figure			4.0		dB
FREQUENCY = 4000 MHz					
Gain		17.8	18.6	19.4	dB
vs. Frequency	±50 MHz		±0.14		dB
vs. Temperature	−40°C ≤ T <sub>A</sub> ≤ +85°C		±1.0		dB
vs. Supply	4.75 V to 5.25 V		±0.19		dB
Output 1 dB Compression Point			13.1		dBm
Output Third-Order Intercept	Δf = 1 MHz, output power (P <sub>OUT</sub> ) = −3 dBm per tone		29.0		dBm
Noise Figure			4.6		dB
FREQUENCY = 5000 MHz					
Gain			16.8		dB
vs. Frequency	±50 MHz		±0.05		dB
vs. Temperature	−40°C ≤ T <sub>A</sub> ≤ +85°C		±1.2		dB
vs. Supply	4.75 V to 5.25 V		±0.20		dB
Output 1 dB Compression Point			9.9		dBm
Output Third-Order Intercept	Δf = 1 MHz, output power (P <sub>OUT</sub> ) = −3 dBm per tone		31.8		dBm
Noise Figure			4.8		dB
FREQUENCY = 5800 MHz					
Gain			15.9		dB
vs. Frequency	±50 MHz		±0.20		dB
vs. Temperature	−40°C ≤ T <sub>A</sub> ≤ +85°C		±1.3		dB
vs. Supply	4.75 V to 5.25 V		±0.20		dB
Output 1 dB Compression Point			9.4		dBm
Output Third-Order Intercept	Δf = 1 MHz, output power (P <sub>OUT</sub> ) = −3 dBm per tone		28.4		dBm
Noise Figure			5.2		dB
POWER INTERFACE					
Supply Voltage	V <sub>POS</sub>	4.75	5	5.25	V
Supply Current			56	70	mA
vs. Temperature	−40°C ≤ T <sub>A</sub> ≤ +85°C		−6		mA
Power Dissipation	V <sub>POS</sub> = 5 V		280		mW

## ABSOLUTE MAXIMUM RATINGS

Table 2.

Parameter	Rating
Supply Voltage, $V_{POS}$	6.5 V
Input Power (50 $\Omega$ Impedance)	18 dBm
Internal Power Dissipation (Pad Soldered to Ground)	400 mW
Maximum Junction Temperature	150°C
Operating Temperature Range	−40°C to +105°C
Storage Temperature Range	−65°C to +150°C

Stresses at or above those listed under Absolute Maximum Ratings may cause permanent damage to the product. This is a stress rating only; functional operation of the product at these or any other conditions above those indicated in the operational section of this specification is not implied. Operation beyond the maximum operating conditions for extended periods may affect product reliability.

## THERMAL RESISTANCE

Table 3 lists the junction-to-air thermal resistance ( $\theta_{JA}$ ) and the junction-to-case thermal resistance ( $\theta_{JC}$ ) for the ADL5545.

Table 3. Thermal Resistance

Package Type	$\theta_{JA}$ <sup>1</sup>	$\theta_{JC}$ <sup>2</sup>	Unit
3-Lead SOT-89 (RK-3)	53	15	°C/W

<sup>1</sup> Measured on the ADL5545 evaluation board. For more information about board layout, see the Soldering Information and Recommended PCB Land Pattern section.

<sup>2</sup> Based on simulation with a standard JEDEC board per JESD51.

## ESD CAUTION



**ESD (electrostatic discharge) sensitive device.** Charged devices and circuit boards can discharge without detection. Although this product features patented or proprietary protection circuitry, damage may occur on devices subjected to high energy ESD. Therefore, proper ESD precautions should be taken to avoid performance degradation or loss of functionality.

## PIN CONFIGURATION AND FUNCTION DESCRIPTIONS

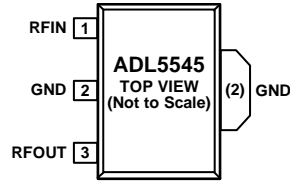

### NOTES

1. THE EXPOSED PAD ENCOMPASSES PIN 2 AND THE TAB AT THE TOP SIDE OF THE PACKAGE. SOLDER THE EXPOSED PAD TO A LOW IMPEDANCE GROUND PLANE FOR ELECTRICAL GROUNDING AND THERMAL TRANSFER.

11385-002

Figure 2. Pin Configuration

Table 4. Pin Function Descriptions

Pin No.	Mnemonic	Description
1	RFIN	RF Input. This pin requires a dc blocking capacitor.
2	GND	Ground. Connect this pin to a low impedance ground plane.
3	RFOUT	RF Output and Supply Voltage. DC bias is provided to this pin through an inductor that is connected to the external power supply. The RF path requires a dc blocking capacitor.
	EPAD	Exposed Pad. The exposed pad encompasses Pin 2 and the tab at the top side of the package. Solder the exposed pad to a low impedance ground plane for electrical grounding and thermal transfer.

# TYPICAL PERFORMANCE CHARACTERISTICS

## 500 MHz TO 4 GHz FREQUENCY BAND

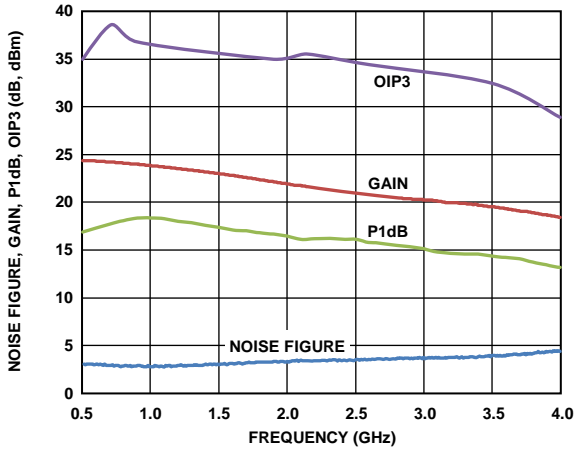

Figure 3. Noise Figure, Gain, P1dB, and OIP3 vs. Frequency

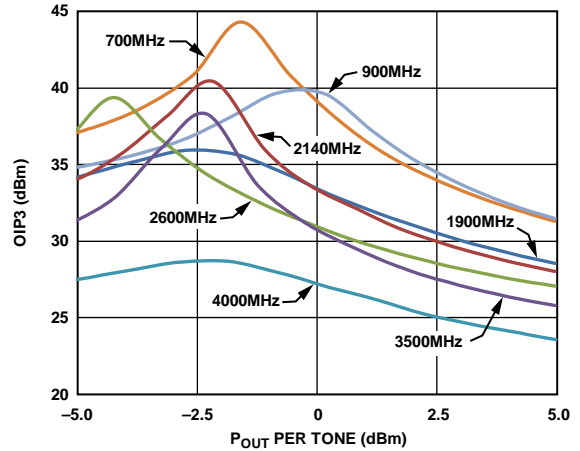

Figure 6. OIP3 vs. Output Power ( $P_{out}$ ) and Frequency

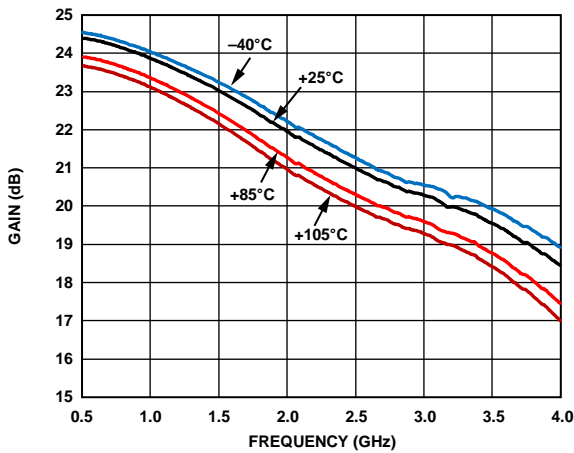

Figure 4. Gain vs. Frequency and Temperature

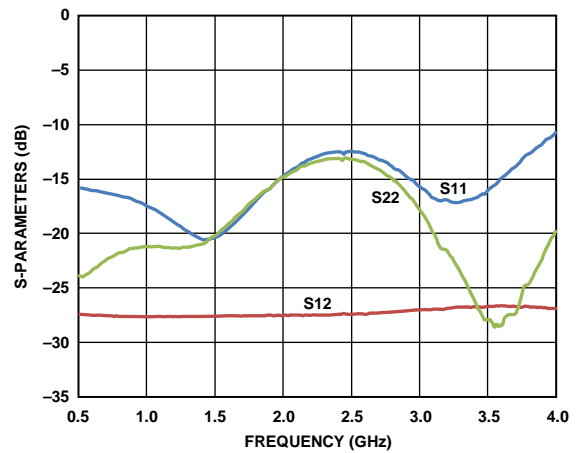

Figure 7. Input Return Loss ( $S_{11}$ ), Output Return Loss ( $S_{22}$ ), and Reverse Isolation ( $S_{12}$ ) vs. Frequency

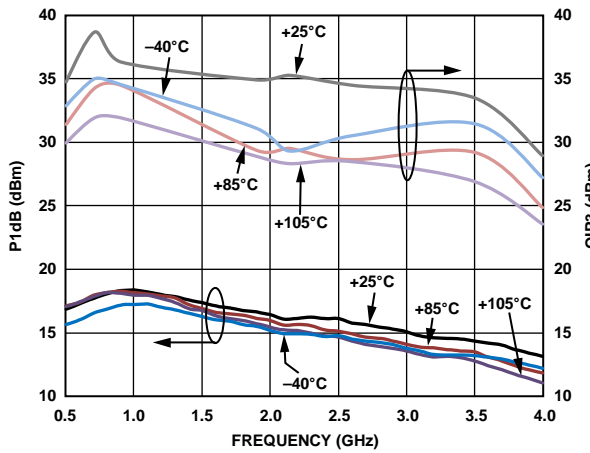

Figure 5. P1dB and OIP3 vs. Frequency and Temperature

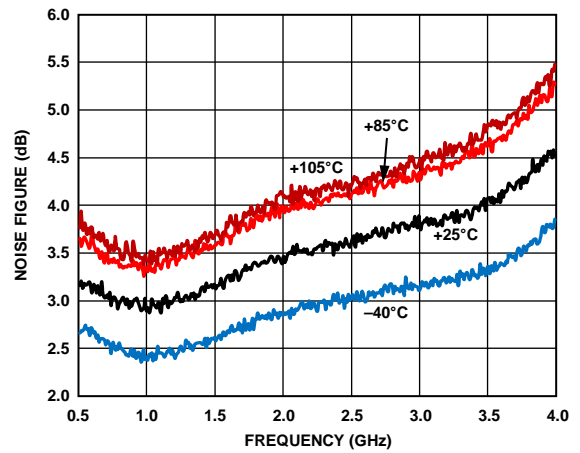

Figure 8. Noise Figure vs. Frequency and Temperature

100 MHz TO 500 MHz FREQUENCY BAND

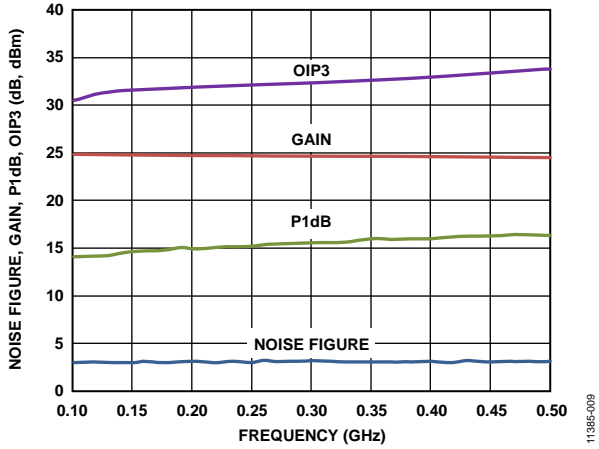

Figure 9. Noise Figure, Gain, P1dB, and OIP3 vs. Frequency, Low Frequency Configuration

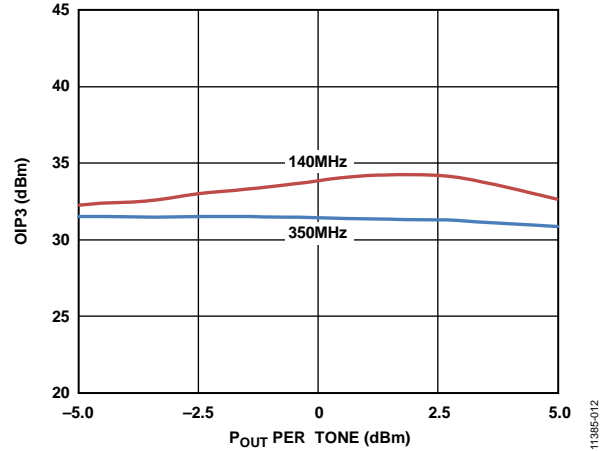

Figure 12. OIP3 vs. Output Power ( $P_{OUT}$ ) and Frequency, Low Frequency Configuration

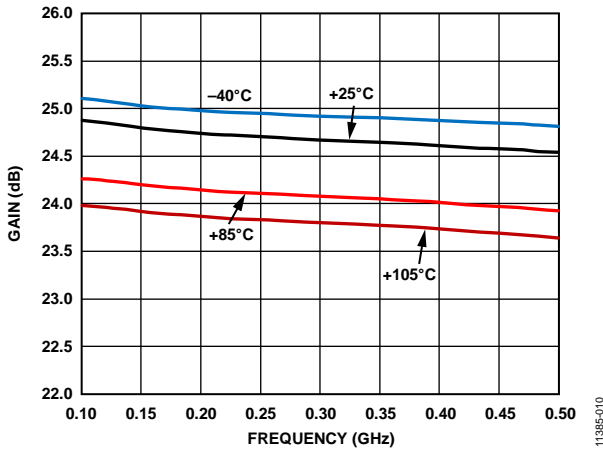

Figure 10. Gain vs. Frequency and Temperature, Low Frequency Configuration

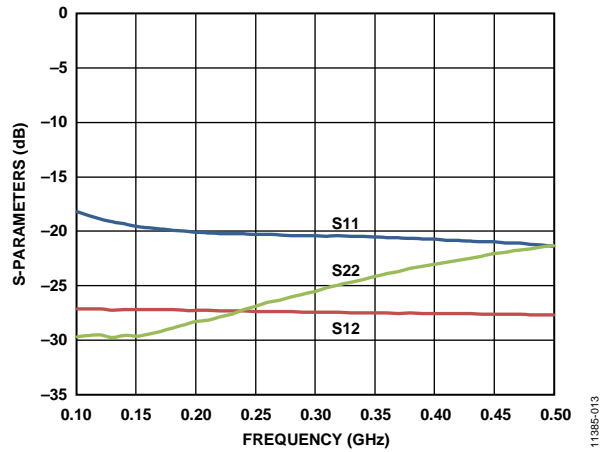

Figure 13. Input Return Loss (S11), Output Return Loss (S22), and Reverse Isolation (S12) vs. Frequency, Low Frequency Configuration

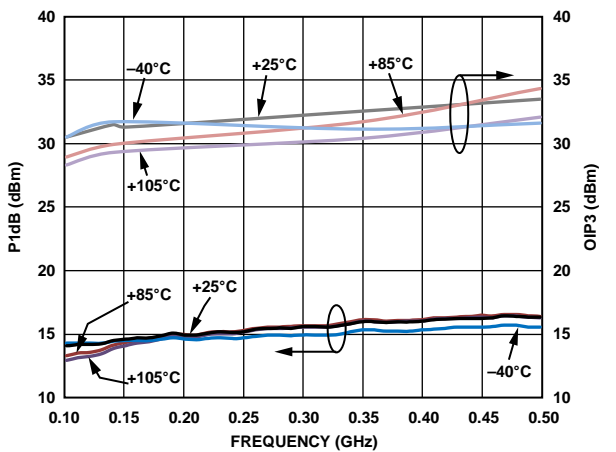

Figure 11. P1dB and OIP3 vs. Frequency and Temperature, Low Frequency Configuration

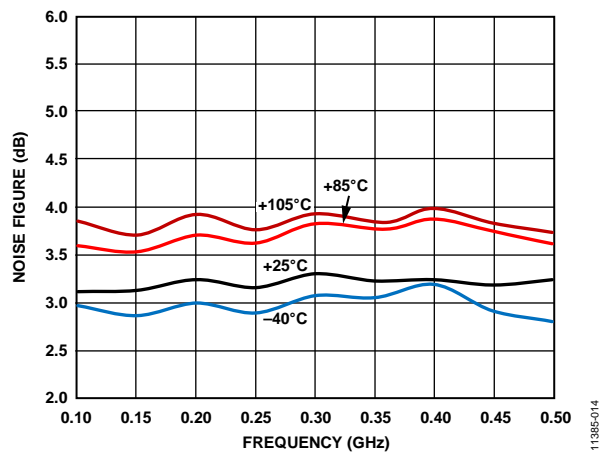

Figure 14. Noise Figure vs. Frequency and Temperature, Low Frequency Configuration



4 GHz TO 6 GHz FREQUENCY BAND

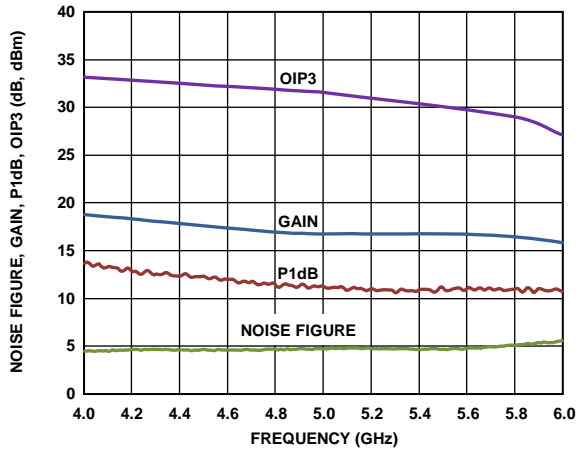

Figure 15. Noise Figure, Gain, P1dB, and OIP3 vs. Frequency, High Frequency Configuration

11385-015

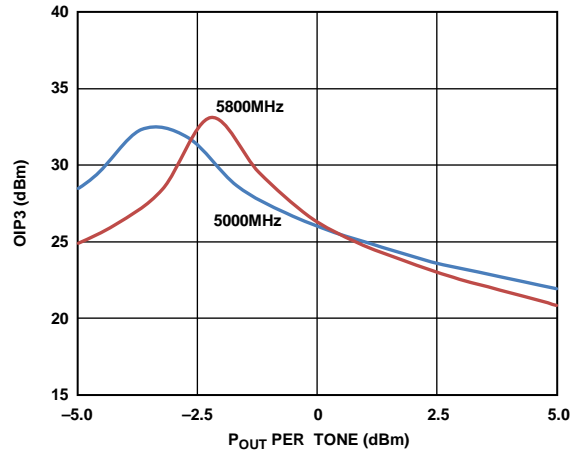

Figure 18. OIP3 vs. Output Power ( $P_{OUT}$ ) and Frequency, High Frequency Configuration

11385-018

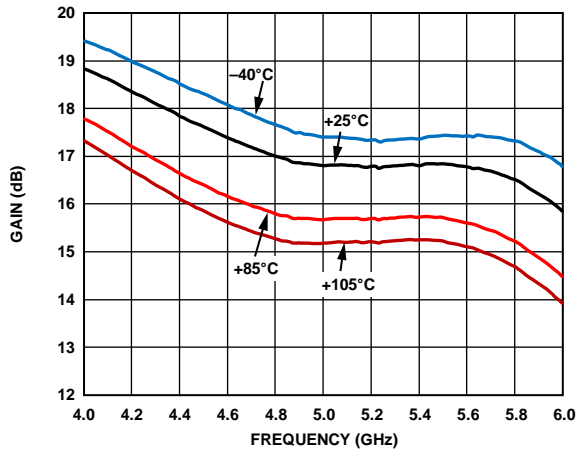

Figure 16. Gain vs. Frequency and Temperature, High Frequency Configuration

11385-016

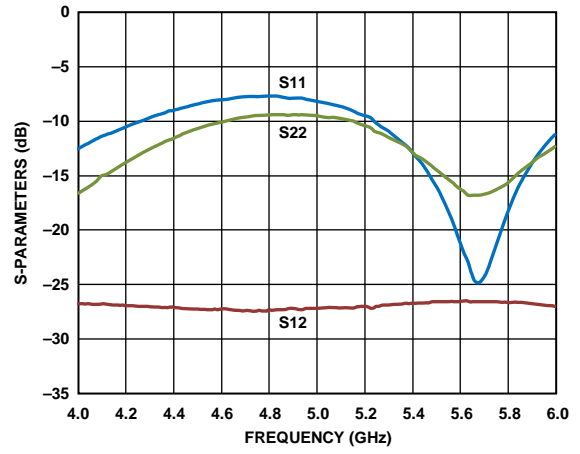

Figure 19. Input Return Loss (S11), Output Return Loss (S22), and Reverse Isolation (S12) vs. Frequency, High Frequency Configuration

11385-019

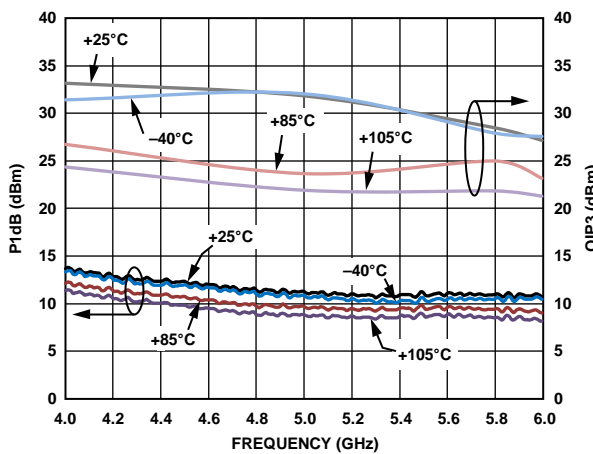

Figure 17. P1dB and OIP3 vs. Frequency and Temperature, High Frequency Configuration

11385-017

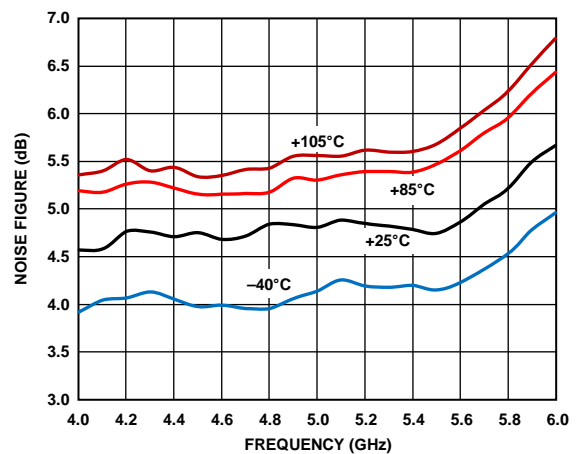

Figure 20. Noise Figure vs. Frequency and Temperature, High Frequency Configuration

11385-020

GENERAL

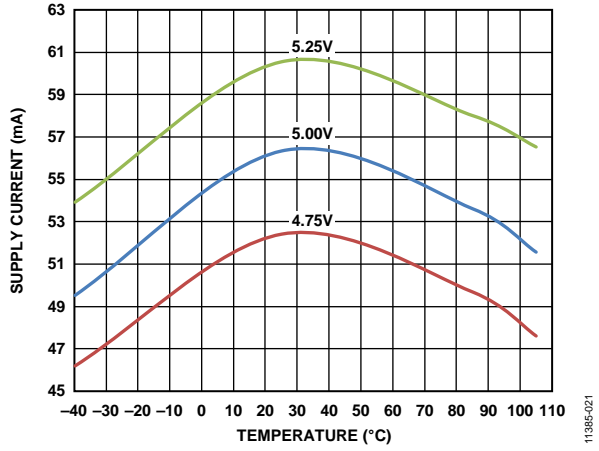

Figure 21. Supply Current vs. Temperature

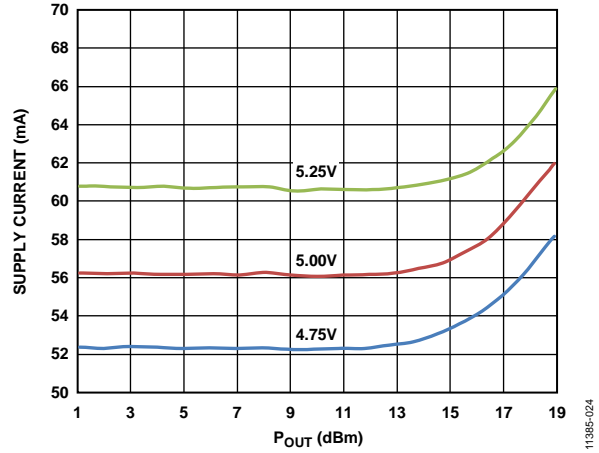

Figure 24. Supply Current vs. POUT at 900 MHz

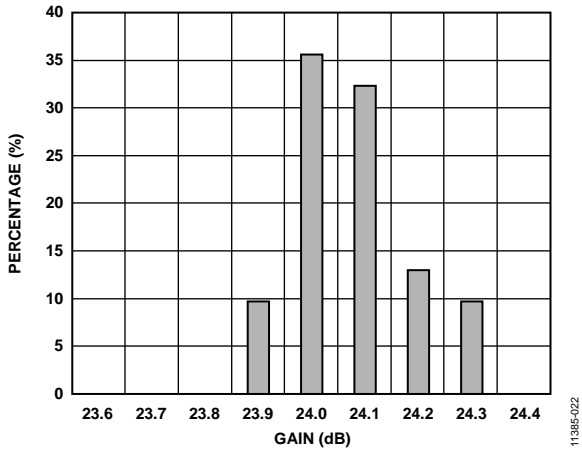

Figure 22. Gain Distribution at 900 MHz

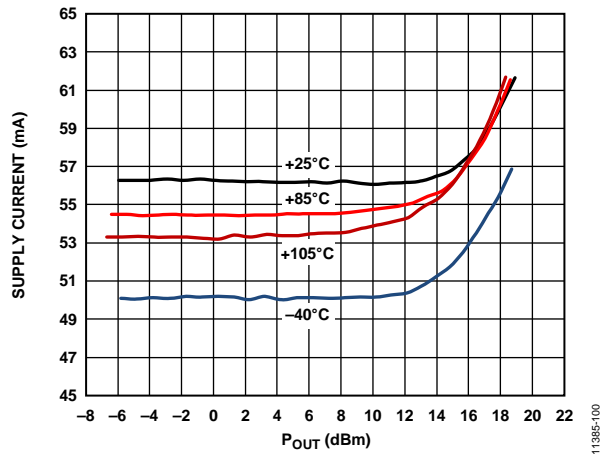

Figure 25. Supply Current vs. POUT and Temperature at 900 MHz

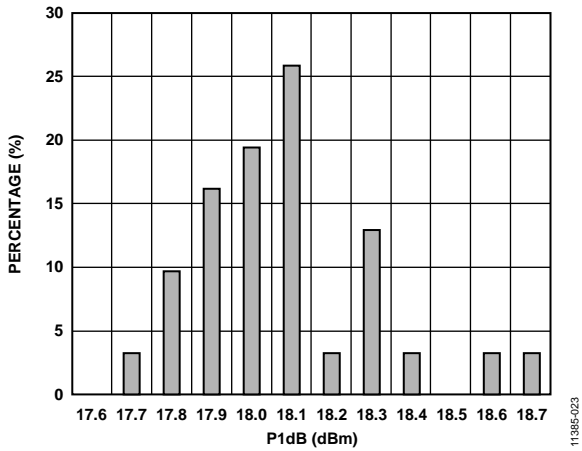

Figure 23. P1dB Distribution at 900 MHz

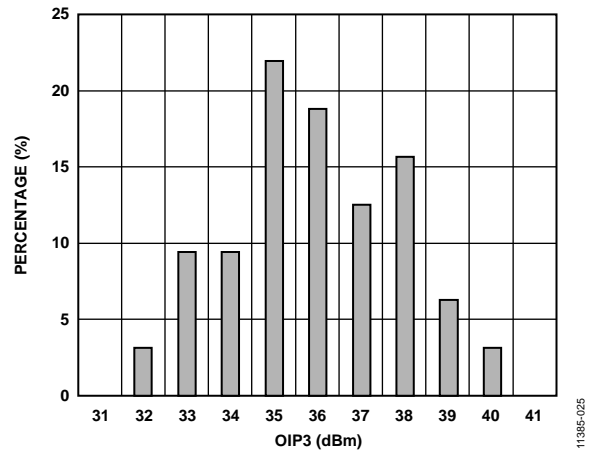

Figure 26. OIP3 Distribution at 900 MHz, POUT = -3 dBm per Tone

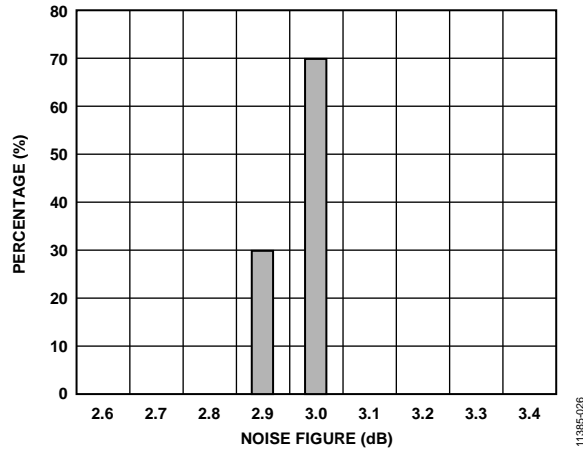

Figure 27. Noise Figure Distribution at 900 MHz

11385-026

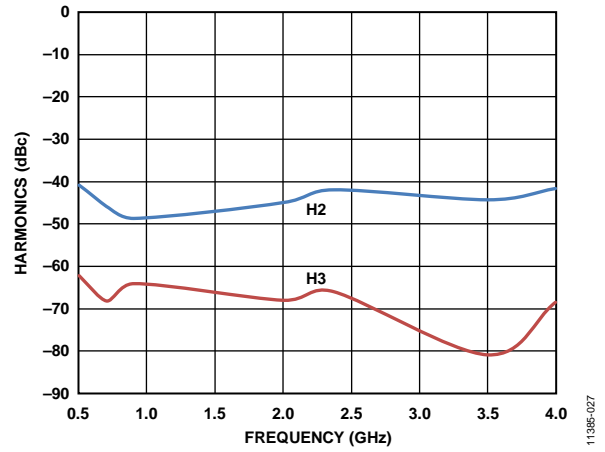

Figure 28. Single-Tone Harmonics vs. Frequency, P<sub>OUT</sub> = 0 dBm

11385-027

# APPLICATIONS INFORMATION

## BASIC CONNECTIONS

Figure 29 shows the basic connections for operating the ADL5545. The device supports operation from 30 MHz to 6 GHz. However, for optimal performance at lower and higher frequency bands, the board configuration must be adjusted. Table 5 lists the recommended board configuration to operate the device at various frequency bands.

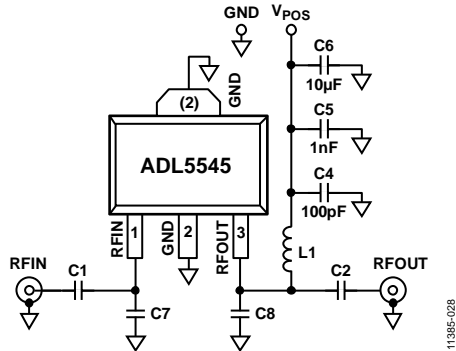

Figure 29. Basic Connections

A 5 V dc bias is supplied to the amplifier through the bias inductor connected to RFOUT (Pin 3). The bias voltage must be decoupled using 100 pF, 1 nF, and 10 µF power supply decoupling capacitors. The typical current consumption for the ADL5545 is 56 mA.

At low and high frequencies, the device exhibits improved performance with the suggested setup configuration listed in Table 5. Figure 30 to Figure 33 provide a comparison of the performance of the device at the 100 MHz to 500 MHz and 4 GHz to 6 GHz bands when driven with the optimal setup configuration and the default setup configuration.

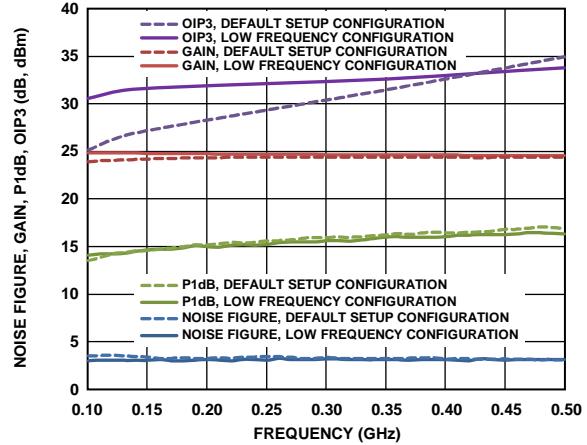

Figure 30. Noise Figure, Gain, P1dB, and OIP3 vs. Frequency, 100 MHz to 500 MHz, Comparison of Performance with the Optimized Settings and the Default Configuration

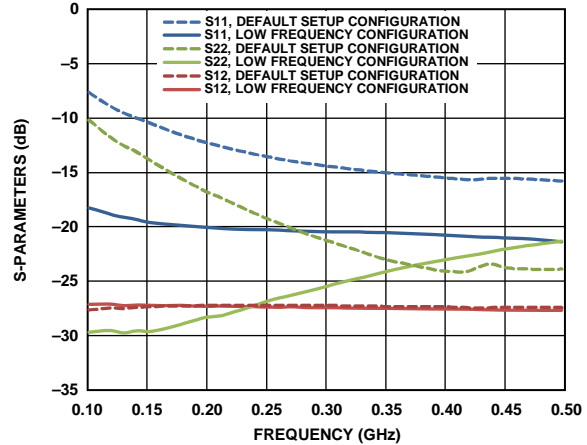

Figure 31. Return Loss and Reverse Isolation, 100 MHz to 500 MHz, Comparison of Performance with the Optimized Settings and the Default Configuration

Table 5. Recommended Components for Basic Connections

Frequency Band	AC Coupling Capacitors (0402)		DC Bias Inductor (0603HP)	High Frequency Matching Capacitors (0402)	
	C1	C2	L1	C7	C8
100 MHz to 500 MHz	100 nF	100 nF	1000 nH	Do not install	Do not install
500 MHz to 4 GHz (default)	100 pF	100 pF	100 nH	Do not install	Do not install
4 GHz to 6 GHz	100 pF	100 pF	12 nH	0.1 pF	0.1 pF

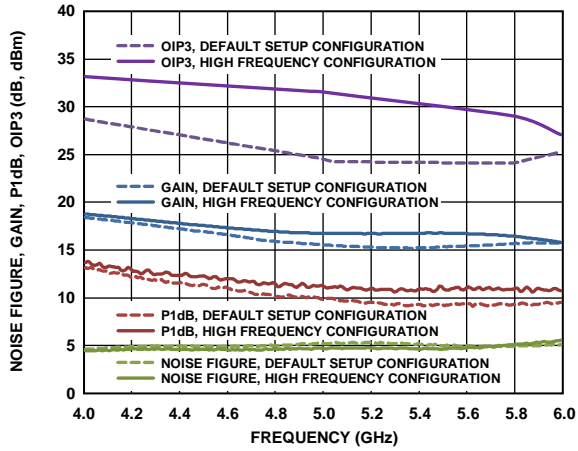

Figure 32. Noise Figure, Gain, P1dB, and OIP3 vs. Frequency, 4 GHz to 6 GHz, Comparison of Performance with the Optimized Settings and the Default Configuration

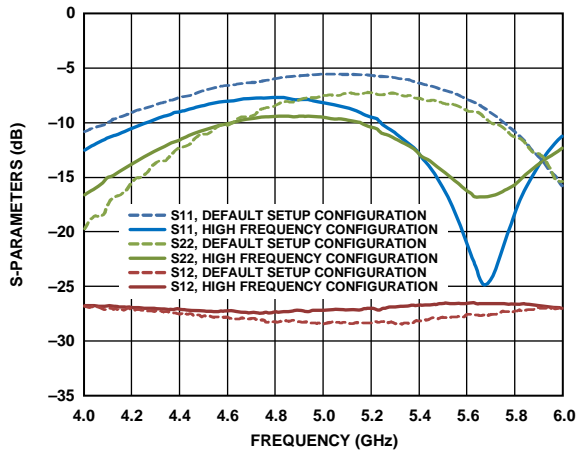

Figure 33. Return Loss and Reverse Isolation, 4 GHz to 6 GHz, Comparison of Performance with the Optimized Settings and the Default Configuration

**SOLDERING INFORMATION AND RECOMMENDED PCB LAND PATTERN**

Figure 34 shows the recommended land pattern for the ADL5545. To minimize thermal impedance, the exposed pad on the underside of the SOT-89 package is soldered to a ground plane, along with Pin 2. If multiple ground layers exist, stitch the layers together using vias.

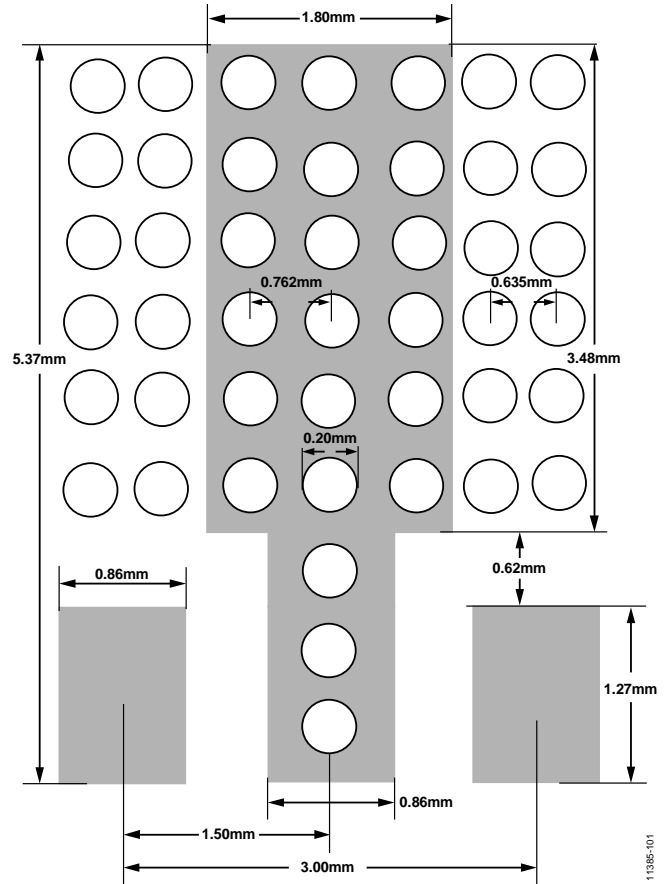

Figure 34. Recommended Land Pattern

The land pattern on the ADL5545 evaluation board provides a measured thermal resistance ( $\theta_{JA}$ ) of 53°C/W. To measure  $\theta_{JA}$ , the temperature at the top of the SOT-89 package is found with an IR temperature gun. Thermal simulation suggests a junction temperature 10°C higher than the top-of-package temperature. With additional measurements of the ambient temperature and I/O power,  $\theta_{JA}$  can be determined.

**OPERATION DOWN TO 30 MHz**

To operate the ADL5545 at frequencies below 100 MHz, a feedback network must be implemented between the input and output ports of the device to ensure stability. Figure 35 shows a sample configuration used to evaluate the device at frequencies below 100 MHz. Figure 36 to Figure 38 demonstrate the performance of the device in this configuration.

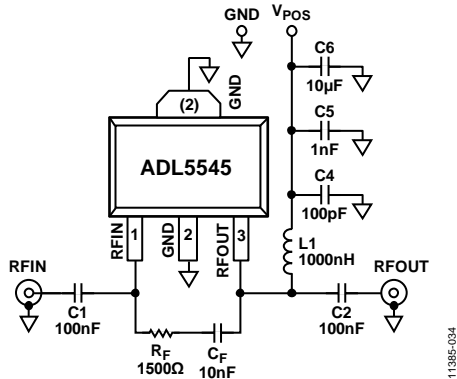

Figure 35. Setup for Low Frequency Operation Down to 30 MHz

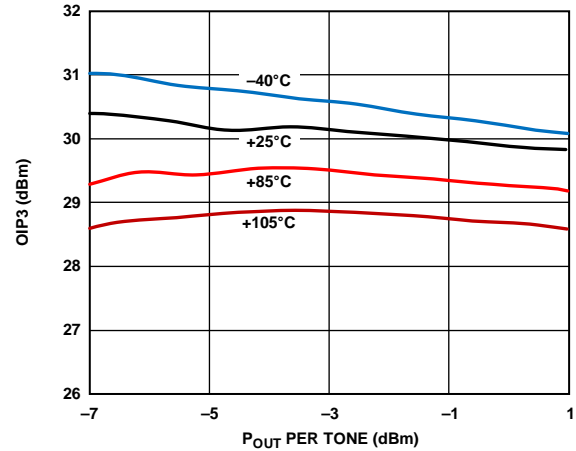

Figure 38. OIP3 vs. POUT at 30 MHz

**W-CDMA ACPR PERFORMANCE**

Figure 39 shows a plot of the adjacent channel power ratio (ACPR) vs. POUT for the ADL5545. The signal type used is a single wideband code division multiple access (W-CDMA) carrier (Test Model 1-64) at 2140 MHz. This signal is generated by a very low ACPR source. ACPR is measured at the output by a high dynamic range spectrum analyzer that incorporates an instrument noise-correction function.

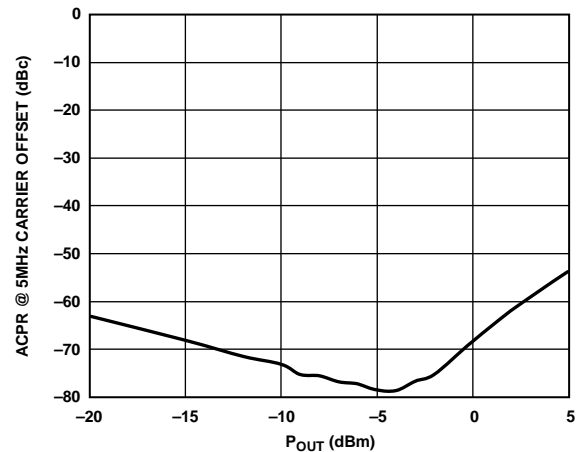

Figure 39. ACPR vs. POUT, Single W-CDMA Carrier (Test Model 1-64) at 2140 MHz

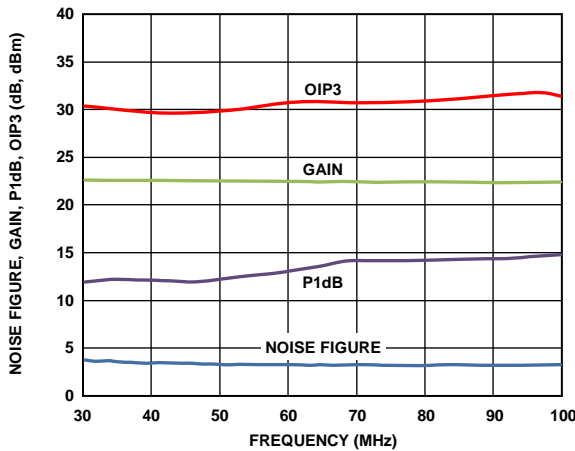

Figure 36. Noise Figure, Gain, P1dB, and OIP3 vs. Frequency, 30 MHz to 100 MHz

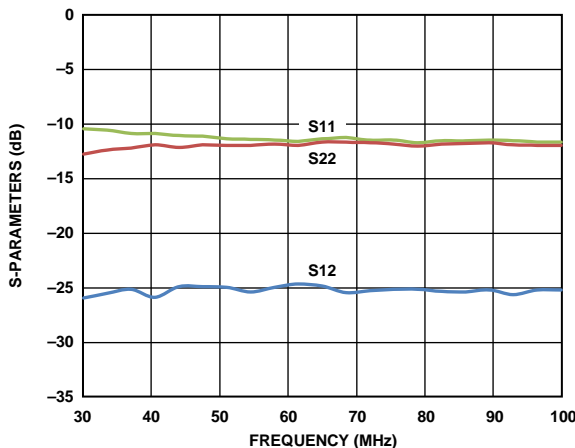

Figure 37. Return Loss and Reverse Isolation, 30 MHz to 100 MHz

## EVALUATION BOARD

Figure 40 shows the ADL5545 evaluation board layout. Figure 41 shows the schematic for the evaluation board. The board is powered by a single 5 V supply. Table 6 lists the components used on the evaluation board. Power can be applied to the board through clip-on leads ( $V_{SUP}$ , GND).

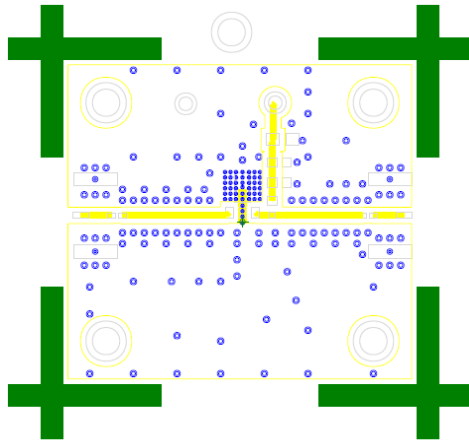

Figure 40. Evaluation Board Layout (Top)

11385-039

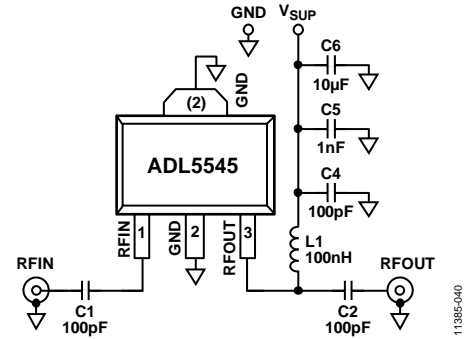

Figure 41. Evaluation Board Schematic

11385-040

Table 6. Evaluation Board Configuration Options

Component	Function	Default Value
C1, C2	AC coupling capacitors	100 pF, 0402
L1	DC bias inductor	100 nH, 0603 (Coilcraft 0603HP or equivalent)
$V_{SUP}$ and GND	Clip-on terminals for power supply	
C4, C5, C6	Power supply decoupling capacitors	C4: 100 pF, 0603 C5: 1 nF, 0603 C6: 10 $\mu$ F, 1206

OUTLINE DIMENSIONS

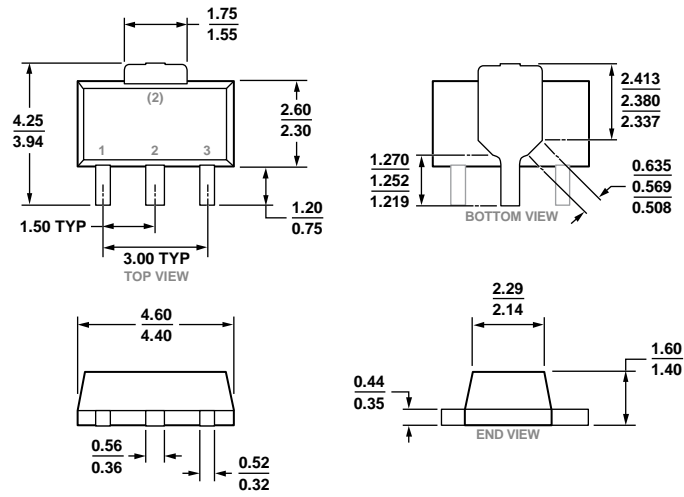

COMPLIANT TO JEDEC STANDARDS TO-243

Figure 42. 3-Lead Small Outline Transistor Package [SOT-89] (RK-3)

Dimensions shown in millimeters

ORDERING GUIDE

Model <sup>1</sup>	Temperature Range	Package Description	Package Option
ADL5545ARKZ-R7	-40°C to +105°C	3-Lead SOT-89, 7" Tape and Reel	RK-3
ADL5545-EVALZ	-40°C to +105°C	Evaluation Board	

<sup>1</sup> Z = RoHS Compliant Part.



**NOTES**

**NOTES**

## X-ON Electronics

Largest Supplier of Electrical and Electronic Components

*Click to view similar products for [RF Amplifier](#) category:*

*Click to view products by [Analog Devices](#) manufacturer:*

Other Similar products are found below :

[A82-1](#) [BGA622H6820XTSA1](#) [BGA 728L7 E6327](#) [BGB719N7ESDE6327XTMA1](#) [HMC397-SX](#) [HMC405](#) [HMC561-SX](#) [HMC8120-SX](#)  
[HMC8121-SX](#) [HMC-ALH382-SX](#) [HMC-ALH476-SX](#) [SE2433T-R](#) [SMA3101-TL-E](#) [SMA39](#) [A66-1](#) [A66-3](#) [A67-1](#) [A81-2](#) [LX5535LQ](#)  
[LX5540LL](#) [MAAM02350](#) [HMC3653LP3BETR](#) [HMC549MS8GETR](#) [HMC576-SX](#) [HMC-ALH435-SX](#) [SMA101](#) [SMA32](#) [SMA411](#)  
[SMA531](#) [SST12LP19E-QX6E](#) [WPM0510A](#) [HMC5879LS7TR](#) [HMC1087F10](#) [HMC1086](#) [HMC1016](#) [SMA1212](#) [MAX2689EWS+T](#)  
[MAAMSS0041TR](#) [MAAM37000-A1G](#) [LTC6430AIUF-15#PBF](#) [SMA70-2](#) [SMA4011](#) [A231](#) [HMC-AUH232](#) [LX5511LQ](#) [LX5511LQ-TR](#)  
[HMC7441-SX](#) [HMC-ALH310](#) [XD1001-BD-000V](#) [A4011](#)