

FEATURES

- Digitally tunable, lower and upper 3 dB cutoff frequencies
- Optimal wideband rejection: 35 dB
- Single chip replacement for discrete filter banks
- Compact 6.00 mm × 3.00 mm × 0.89 mm LGA package

ENHANCED PRODUCT FEATURES

- Supports defense and aerospace applications (AQEC standard)
- Military temperature range (such as -55°C to +105°C)
- Controlled manufacturing baseline
- One assembly/test site
- One fabrication site
- Enhanced product change notification
- Qualification data available on request

APPLICATIONS

- Test and measurement equipment
- Military radar and electronic warfare and electronic countermeasures
- Satellite communications
- Industrial and medical equipment

GENERAL DESCRIPTION

The ADMV8913-EP is a fully monolithic microwave integrated circuit (MMIC) that features a digitally selectable operating frequency. The device has an integrated high-pass filter (HPF) and an integrated low-pass filter (LPF) that allows a pass-band response within the 6.6 GHz to 11.9 GHz frequency range.

The flexible architecture of the ADMV8913-EP allows for the 3 dB cutoff frequency (f_{3dB}) of the high-pass and the low-pass filter to be controlled independently. The digital logic control on each filter is 4 bits wide (16 states) and controls the on-chip reactive elements to adjust the f_{3dB} . The typical insertion loss is 5.3 dB, and the wideband rejection is 35 dB, which is ideally suitable for minimizing system harmonics.

This tunable filter can be used as a smaller alternative to large switched filter banks and cavity tuned filters, and the ADMV8913-EP provides a dynamically adjustable solution in advanced communications applications.

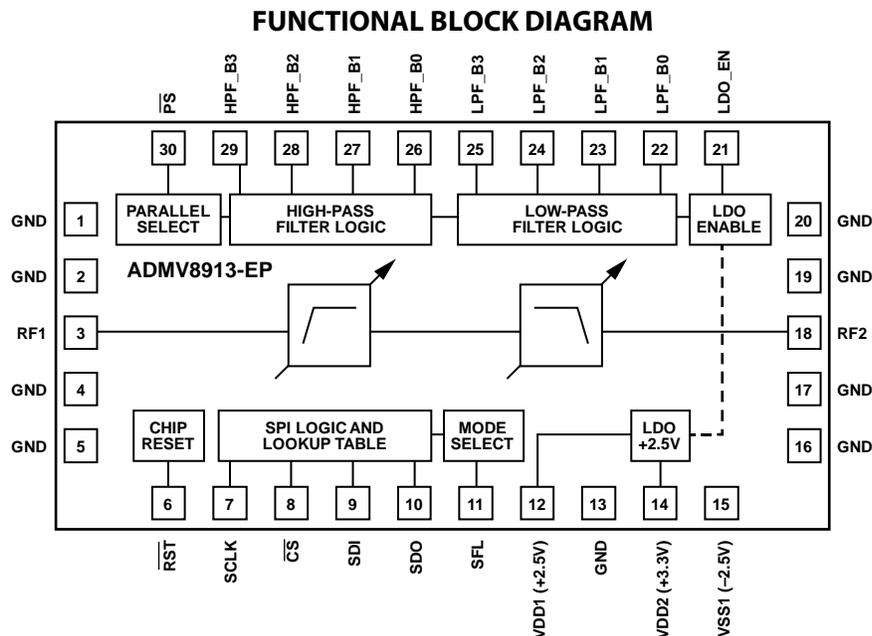

Figure 1.

TABLE OF CONTENTS

Features	1	RF Connections	11
Enhanced Product Features	1	SPI Configuration	11
Applications	1	Mode Selection	12
General Description	1	Parallel Mode	12
Functional Block Diagram	1	SPI Write Mode	12
Revision History	2	Filter Settings	12
Specifications	3	SPI Fast Latch Mode	12
Timing Specifications	4	SPI Streaming	13
Absolute Maximum Ratings	6	Chip Reset	13
Electrostatic Discharge (ESD) Ratings	6	Applications Information	14
ESD Caution	6	Printed Circuit Board (PCB) Design Guidelines	14
Pin Configuration and Function Descriptions	7	Programming Flow Chart	15
Typical Performance Characteristics	9	Register Summary	16
Theory of Operation	11	Register Details	19
Chip Architecture	11	Outline Dimensions	23
Tunable High-Pass Filter	11	Ordering Guide	23
Tunable Low-Pass Filter	11		

REVISION HISTORY

5/2021—Revision 0: Initial Version

SPECIFICATIONS

T_A = 25°C, unless otherwise noted.

Table 1.

Parameter	Min	Typ	Max	Unit	Test Conditions/Comments
FREQUENCY RANGE	6.6		11.9	GHz	HPF State 0 and LPF State 15.
BANDWIDTH (3 dB)		1 to 5		GHz	A smaller bandwidth is possible with additional insertion loss.
INSERTION LOSS		5.3		dB	
RETURN LOSS		16.5		dB	
REJECTION FREQUENCY OFFSET					Measured at 35 dB rejection.
HPF					
State 0		-1.09		ΔGHz	
State 15		-1.76		ΔGHz	
LPF					
State 0		2		ΔGHz	
State 15		3.18		ΔGHz	
RE-ENTRY FREQUENCY		40		GHz	≤30 dB.
CUTOFF FREQUENCY (f _{3dB})					3 dB cutoff.
HPF					
State 0		6.4		GHz	LPF State 15.
State 15		11.4		GHz	LPF State 15.
LPF					
State 0		7.2		GHz	HPF State 0.
State 15		12.3		GHz	HPF State 0.
RESOLUTION					4 bits per filter.
HPF		0.33		GHz	
LPF		0.35		GHz	
DYNAMIC PERFORMANCE					
Input Power for 0.1 dB Compression (P _{0.1dB})		21		dBm	
Input Third-Order Intercept (IP ₃)		44		dBm	Input power (P _{IN}) = 5 dBm per tone.
Group Delay Flatness		0.4		ns	HPF State 0 and LPF State 15.
Amplitude Settling Time		1		μs	To within ≤1 dB of static insertion loss.
Phase Settling Time		1		μs	To within ≤1° of static phase.
Temperature Variation					HPF State 5 and LPF State 14.
Amplitude		-0.013		dB/°C	At 10 GHz.
Center Frequency		-70		ppm/°C	8 GHz to 12 GHz.
RESIDUAL PHASE NOISE					
At 1 MHz Offset		-170		dBc/Hz	
SUPPLY VOLTAGE					
VSS1	-2.6	-2.5	-2.4	V	
VDD1	2.4	2.5	2.6	V	By default, the VDD1 voltage is generated by the on-chip low dropout (LDO) regulator. Do not apply an external voltage to VDD1 when the LDO regulator is enabled.
VDD2	3.2	3.3	3.4	V	
SUPPLY CURRENT (STATIC)					
VSS1		-2		μA	
VDD2		125		μA	LDO regulator enabled. The VDD1 supply current is included within the VDD2 supply current.

Parameter	Min	Typ	Max	Unit	Test Conditions/Comments
SUPPLY CURRENT (DYNAMIC) VDD2		$f_{\text{SCLK}}/3.6$		mA	LDO regulator enabled. f_{SCLK} is the SCLK toggle frequency in MHz. For example, the continuous serial peripheral interface (SPI) writing at 10 MHz yields 2.8 mA of dynamic supply current.
LOGIC ($\overline{\text{RST}}$, $\overline{\text{CS}}$, SCLK, SDI, SDO, SFL, HPF_Bx, and LPF_Bx)					
Logic Low	-0.3	0	+0.8	V	
Logic High	1.2	3.3	3.6	V	

TIMING SPECIFICATIONS

Table 2.

Parameter	Min	Typ	Max	Unit	Test Conditions/Comments
t ₁	10			ns	$\overline{\text{RST}}$ low time to perform reset
	10			ns	SCLK cycle time (write)
t ₂	20			ns	SCLK cycle time (read)
t ₃	2.5			ns	SCLK high time
t ₄	2.5			ns	SCLK low time
t ₅	5			ns	$\overline{\text{CS}}$ falling edge to SCLK rising edge setup time
t ₆	2			ns	SCLK rising edge to $\overline{\text{CS}}$ hold time
t ₇	5			ns	Minimum $\overline{\text{CS}}$ high time for latching in data (for multiple SPI transactions)
t ₈	5			ns	$\overline{\text{CS}}$ rising edge to next SCLK rising edge ignore
t ₉	5			ns	SDI data setup time
t ₁₀	2			ns	SDI data hold time
t ₁₁	10			ns	SFL falling edge (exiting SFL mode) to $\overline{\text{CS}}$ falling edge time (start SPI transaction)
t ₁₂	10			ns	$\overline{\text{CS}}$ rising edge (end SPI transaction) to SFL rising edge time (entering SFL mode)
t ₁₃	10			ns	SFL rising edge to $\overline{\text{CS}}$ falling edge time
t ₁₄	10			ns	$\overline{\text{CS}}$ cycle time (SFL mode)
t ₁₅	2.5			ns	$\overline{\text{CS}}$ high time (SFL mode)
t ₁₆	2.5			ns	$\overline{\text{CS}}$ low time (SFL mode)
t ₁₇		6		ns	SCLK falling edge to SDO valid (load capacitance (C _L) = 10 pF)
t ₁₈		5		ns	SDO rise and fall time (C _L = 10 pF)
t ₁₉		4		ns	$\overline{\text{CS}}$ rising edge to SDO tristate (C _L = 10 pF)

Timing Diagram

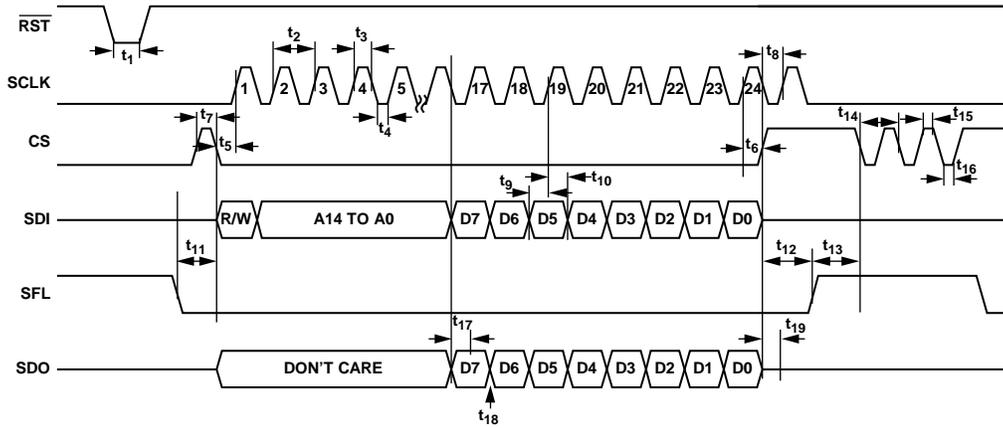

NOTES
 1. FOR READ OPERATION THE DATA BITS IN SDI ARE DON'T CARES.

Figure 2. Timing Diagram

26135-002

ABSOLUTE MAXIMUM RATINGS

Table 3.

Parameter	Rating
Supply	
VDD1	−0.3 V to +2.8 V
VDD2	−0.3 V to +3.6 V
VSS1	−3.6 V to +0.3 V
Digital Control Inputs	
Voltage	−0.3 V to VDD2 + 0.3 V
Current	2 mA
RF Input Power ¹	24 dBm
Temperature	
Operating Range	−55°C to +105°C
Storage Range	−65°C to +150°C
Junction to Maintain 1 Million Hours Mean Time to Failure (MTTF)	135°C
Nominal Junction (T _{PADDLE} = 85°C)	90°C
Moisture Sensitivity Level (MSL) Rating	MSL3

¹ Maximum RF input power valid for frequencies higher than 1 GHz. For incident signals less than this frequency, contact Analog Devices, Inc., to discuss the use case scenario.

Stresses at or above those listed under Absolute Maximum Ratings may cause permanent damage to the product. This is a stress rating only; functional operation of the product at these or any other conditions above those indicated in the operational section of this specification is not implied. Operation beyond the maximum operating conditions for extended periods may affect product reliability.

ELECTROSTATIC DISCHARGE (ESD) RATINGS

The following ESD information is provided for handling of ESD-sensitive devices in an ESD protected area only.

Human body model (HBM) per ANSI/ESDA/JEDEC JS-001.

Field induced charged device model (FICDM) per ANSI/ESDA/JEDEC JS-002.

ESD Ratings for ADMV8913-EP

Table 4. ADMV8913-EP, 30-Terminal LGA

ESD Model	Withstand Threshold (V)	ESD Test Specification	Class
HBM	2500	ANSI/ESDA/JEDEC JS-001-2010	2
FICDM	750	JEDEC JESD22-C101E	III
	750	ANSI/ESDA/JEDEC JS-002	C2b

ESD CAUTION



ESD (electrostatic discharge) sensitive device. Charged devices and circuit boards can discharge without detection. Although this product features patented or proprietary protection circuitry, damage may occur on devices subjected to high energy ESD. Therefore, proper ESD precautions should be taken to avoid performance degradation or loss of functionality.

PIN CONFIGURATION AND FUNCTION DESCRIPTIONS

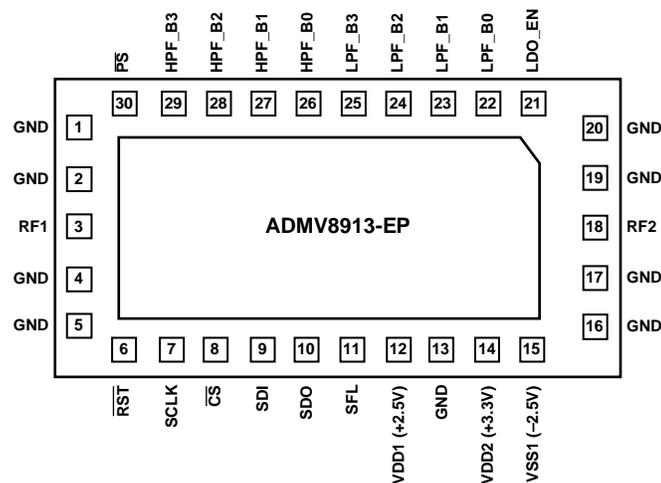

NOTES
1. EXPOSED PAD. THE EXPOSED PAD MUST BE CONNECTED TO THE RF AND DC GROUND.

26139-003

Figure 3. Pin Configuration

Table 5. Pin Function Descriptions

Pin No.	Mnemonic	Description
1, 2, 4, 5, 13, 16, 17, 19, 20	GND	Ground. Connect the GND pins to the RF and dc ground.
3	RF1	RF Pin 1. RF1 is dc-coupled and matched to 50 Ω. Do not apply an external voltage to RF1.
6	RST	Chip Reset. 3.3 V logic. Active low. The RST pin is internally pulled high with a 260 kΩ resistor.
7	SCLK	SPI Clock. 3.3 V logic. The SCLK pin is internally pulled low with a 260 kΩ resistor.
8	CS	SPI Chip Select. 3.3 V logic. Active low. The CS pin is internally pulled low with a 260 kΩ resistor. In parallel mode, the CS pin can be toggled high to latch in logic data synchronously or held high for asynchronous logic update.
9	SDI	SPI Data Input. 3.3 V logic. The SDI pin is internally pulled low with a 260 kΩ resistor.
10	SDO	SPI Data Output. 3.3 V logic. The SDO pin is internally pulled low with a 260 kΩ resistor.
11	SFL	SPI Fast Latch Enable. 3.3 V logic. Set SFL high to enable fast latching of filter states on each rising edge of CS. While SFL is in this mode, the SCLK, SDO, and SDI pins are not active. The SFL pin is internally pulled low with a 260 kΩ resistor.
12	VDD1	2.5 V Power Supply Pin. Place 47 μF, 0.1 μF, and 100 pF decoupling capacitors close to VDD1. By default, the 2.5 V voltage is generated by an on-chip LDO regulator. To provide voltage to VDD1 ground the LDO_EN pin to disable the on-chip LDO regulator. Do not apply an external voltage to VDD1 when the LDO regulator is enabled.
14	VDD2	3.3 V Power Supply Pin. Place 0.1 μF and 100 pF decoupling capacitors close to VDD2.
15	VSS1	-2.5 V Power Supply Pin. Place 0.1 μF and 100 pF decoupling capacitors close to VSS1.
18	RF2	RF Pin 2. RF2 is dc-coupled and matched to 50 Ω. Do not apply an external voltage to RF2.
21	LDO_EN	LDO Regulator Enable Input. 3.3 V logic. The LDO_EN pin is internally pulled high with a 260 kΩ resistor. Ground LDO_EN to disable the on-chip LDO regulator. Leave LDO_EN floating for logic high to enable the on-chip LDO regulator (recommended configuration).
22	LPF_B0	LPF Bit 0. 3.3 V logic. The LPF_B0 pin is internally pulled low with a 260 kΩ resistor.
23	LPF_B1	LPF Bit 1. 3.3 V logic. The LPF_B1 pin is internally pulled low with a 260 kΩ resistor.
24	LPF_B2	LPF Bit 2. 3.3 V logic. The LPF_B2 pin is internally pulled low with a 260 kΩ resistor.
25	LPF_B3	LPF Bit 3. 3.3 V logic. The LPF_B3 pin is internally pulled low with a 260 kΩ resistor.
26	HPF_B0	HPF Bit 0. 3.3 V logic. The HPF_B0 pin is internally pulled low with a 260 kΩ resistor.

Pin No.	Mnemonic	Description
27	HPF_B1	HPF Bit 1. 3.3 V logic. The HPF_B1 pin is internally pulled low with a 260 k Ω resistor.
28	HPF_B2	HPF Bit 2. 3.3 V logic. The HPF_B2 pin is internally pulled low with a 260 k Ω resistor.
29	HPF_B3	HPF Bit 3. 3.3 V logic. The HPF_B3 pin is internally pulled low with a 260 k Ω resistor.
30	\overline{PS}	Parallel/Serial Select Input. 3.3 V logic. The \overline{PS} pin is internally pulled high with a 260 k Ω resistor. A logic low level selects the parallel logic interface. A logic high level selects the SPI.
	EPAD	Exposed Pad. The exposed pad must be connected to the RF and dc ground.

TYPICAL PERFORMANCE CHARACTERISTICS

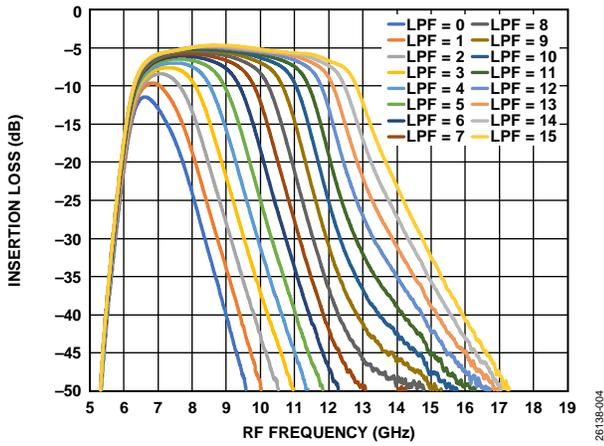

Figure 4. Insertion Loss vs. RF Frequency for HPF State = 0 and LPF State = Swept

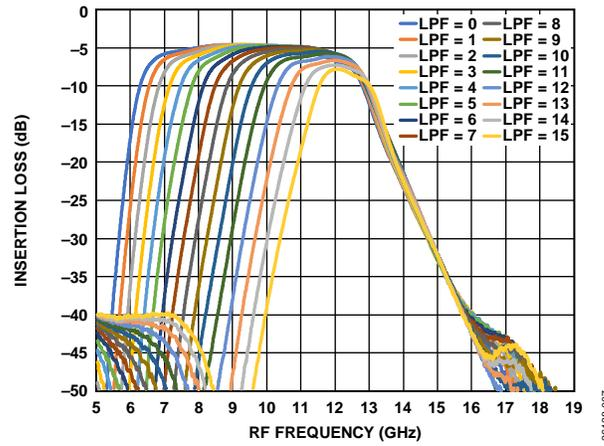

Figure 7. Insertion Loss vs. RF Frequency for LPF State = 15 and HPF State = Swept

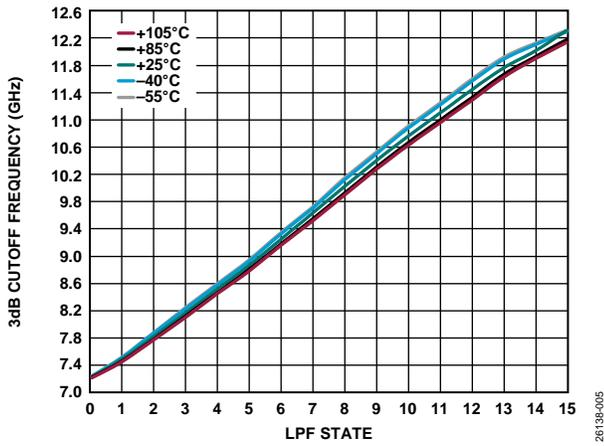

Figure 5. 3 dB Cutoff Frequency vs. LPF State with HPF State = 0 for Various Temperatures

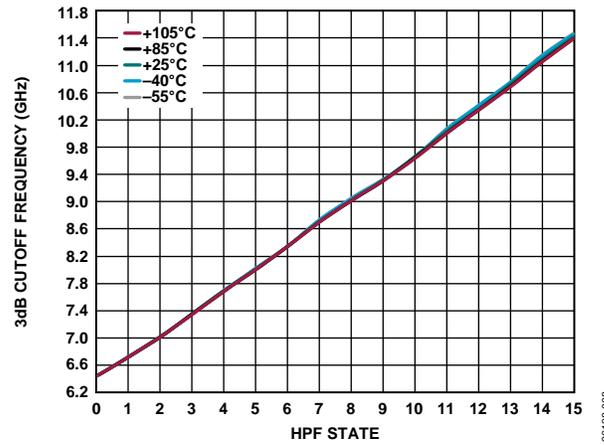

Figure 8. 3 dB Cutoff Frequency vs. HPF State with LPF State = 15 for Various Temperatures

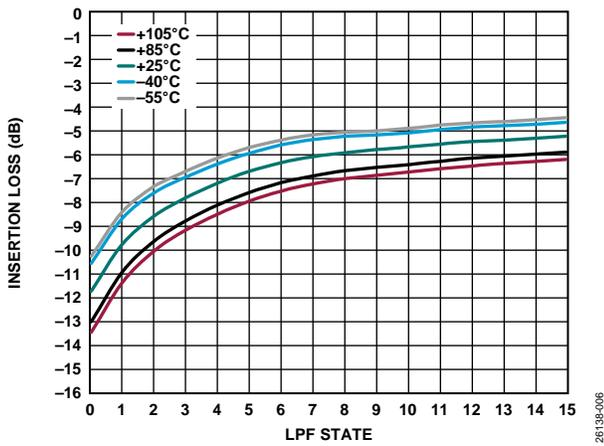

Figure 6. Insertion Loss vs. LPF State with HPF State = 0 for Various Temperatures

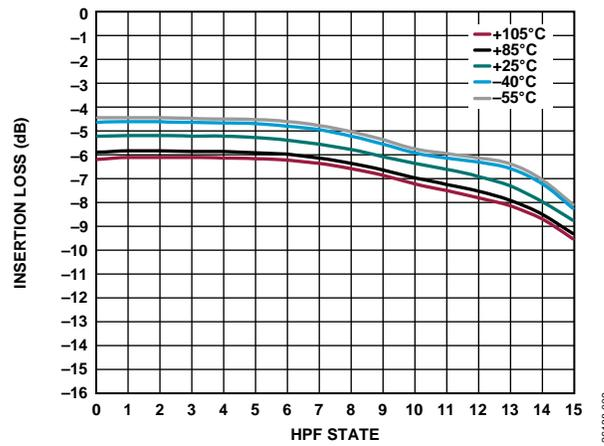

Figure 9. Insertion Loss vs. HPF State with LPF State = 15 for Various Temperatures

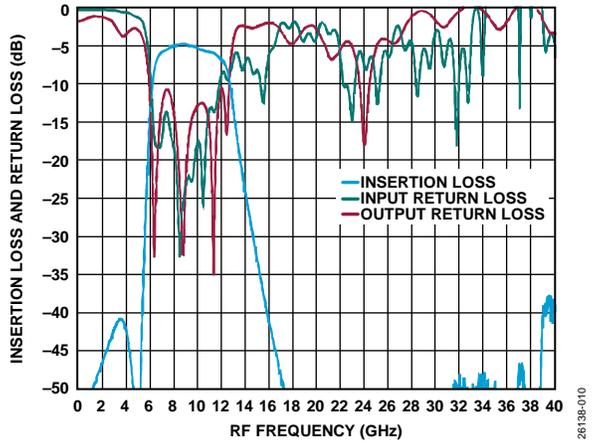

Figure 10. Insertion Loss and Return Loss (Input and Output) vs. RF Frequency, Maximum Bandwidth, HPF State = 0, and LPF State = 15

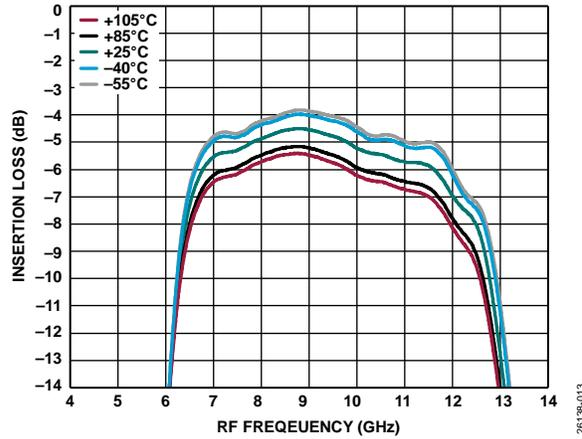

Figure 13. Insertion Loss vs. RF Frequency, Maximum Bandwidth, HPF State = 0, and LPF State = 15 for Various Temperatures

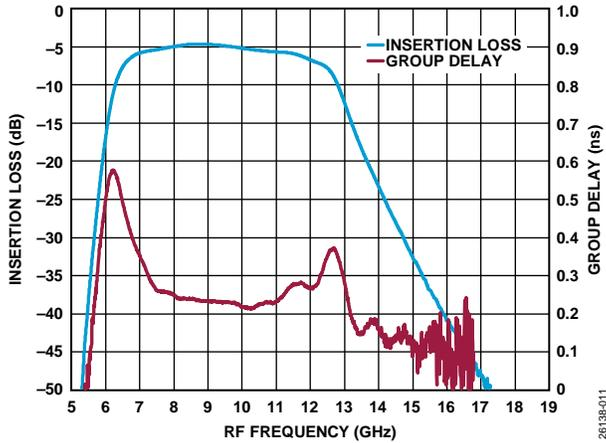

Figure 11. Insertion Loss and Group Delay vs. RF Frequency, Maximum Bandwidth, HPF State = 0, and LPF State = 15

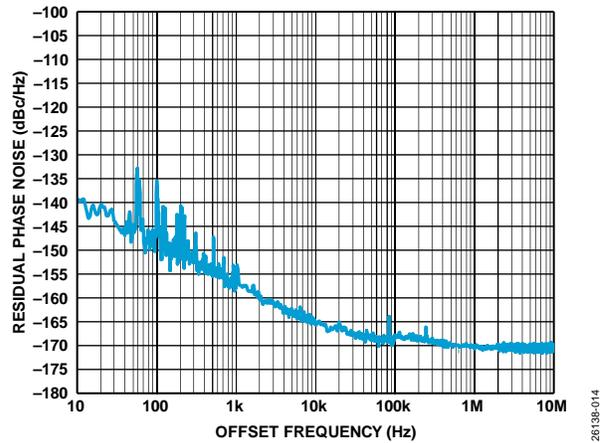

Figure 14. Residual Phase Noise vs. Offset Frequency, HPF State = 0 and LPF State = 15

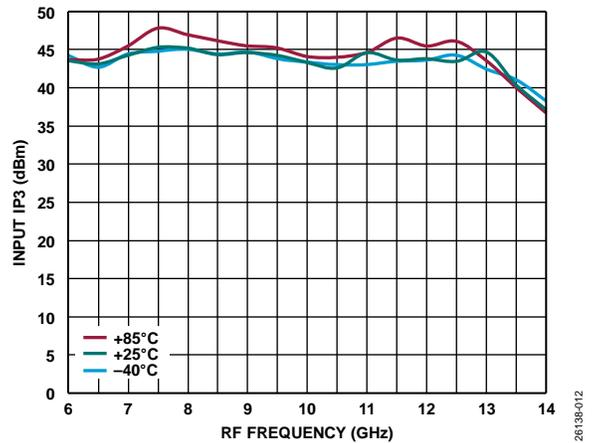

Figure 12. Input IP3 vs. RF Frequency for Various Temperatures, HPF State = 0, and LPF State = 15

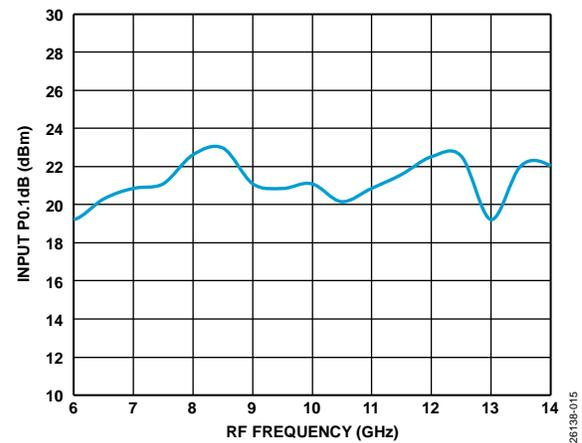

Figure 15. Input P0.1dB vs. RF Frequency, HPF State = 0 and LPF State = 15

THEORY OF OPERATION

CHIP ARCHITECTURE

The ADMV8913-EP is a combination tunable HPF and tunable LPF that can achieve pass-band responses in the X band frequency range. Figure 1 is a conceptual block diagram of the ADMV8913-EP.

TUNABLE HIGH-PASS FILTER

Figure 16 shows a simplified schematic of the HPF, which is a Chebyshev type filter. The f_{3dB} can be adjusted by varying Capacitor C1 to Capacitor C4. These tunable capacitors are constructed with 4-bit digital capacitor arrays, providing 16 distinct values. The step size of these tunable capacitors is adjusted so that each digital binary code increment creates approximately the same increment in the f_{3dB} . Note that the RFC shown in Figure 16 is the internal connection of the HPF and LPF.

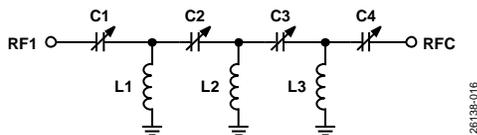

Figure 16. HPF Simplified Schematic

TUNABLE LOW-PASS FILTER

Figure 17 shows a simplified schematic of the LPF, which is a Chebyshev type filter. The f_{3dB} can be adjusted by varying Capacitor C1 to Capacitor C4. These tunable capacitors are constructed with 4-bit digital capacitor arrays, providing 16 distinct values. The step size of these tunable capacitors is adjusted so that each digital binary code increment creates approximately the same increment in the f_{3dB} . Note that the RFC shown in Figure 17 is the internal connection of the HPF and LPF.

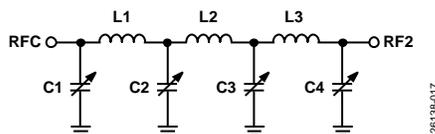

Figure 17. LPF Simplified Schematic

RF CONNECTIONS

The RF1 and RF2 pins of the ADMV8913-EP are dc-coupled to on-chip ESD protection diodes. If a dc voltage is present on the RF1 and RF2 pins from other components within the system, it is recommended to place dc blocking capacitors in series with these pins. The dc blocking capacitors must be selected based on the operating frequency of the filter. Generally, a value greater than 100 pF is sufficient to minimize insertion loss at the lower operating frequencies. At higher operating frequencies, it may be necessary to consider the parasitic elements of the selected capacitor. Figure 18 shows a general model of a capacitor with the parasitic elements. The parasitic series inductance (L_{ESL}) is typically

of most concern given that its impedance can become dominant at frequencies higher than 10 GHz. The other parasitic elements, including the leakage resistance (R_L), the dielectric absorption resistance (R_{DA}), the dielectric absorption capacitance (C_{DA}), and electrical series resistance (R_{ESR}), are less critical elements for consideration but are shown here for completeness.

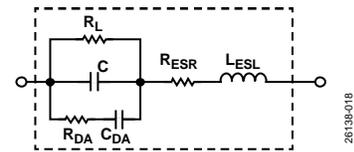

Figure 18. General Model of a Capacitor

SPI CONFIGURATION

The SPI of the ADMV8913-EP allows configuration of the device for specific functions or operations via the 5-pin SPI port. This interface provides users with added flexibility and customization. The SPI consists of five control lines: SFL, SCLK, SDI, SDO, and \overline{CS} . For normal SPI operations, keep the SFL pin low.

The SPI protocol consists of an R/W bit followed by 15 register address bits and 8 data bits. The address field and data field are organized MSB first and end with the LSB.

Set the MSB to 0 for a write operation, and set the MSB to 1 for a read operation. The write cycle must be sampled on the rising edge of SCLK. The 24 bits of the serial write address and data are shifted in on the SDI control line, MSB to LSB. The ADMV8913-EP input logic level for the write cycle supports a 3.3 V interface.

For a read cycle, the R/W bit and the 15 register address bits shift in on the rising edge of SCLK on the SDI control line. Then, 8 bits of serial read data shift out on the SDO control line, MSB first, on the falling edge of SCLK. The output logic level for a read cycle is 3.3 V. The output drivers of the SDO are enabled after the last rising edge of SCLK of the instruction cycle and remain active until the end of the read cycle. In a read operation, when \overline{CS} is deasserted, SDO returns to high impedance until the next read transaction. \overline{CS} is active low and must be deasserted at the end of the write or read sequence.

An active low input on \overline{CS} starts and gates a communication cycle. The \overline{CS} pin allows more than one device to be used on the same serial communications lines. The SDO pin goes to a high impedance state when the \overline{CS} input is high. During the communication cycle, the chip select must stay low. The SPI communications protocol follows the Analog Devices SPI standard. For more information, see the [ADI-SPI Serial Control Interface Standard \(Rev 1.0\)](#).

MODE SELECTION

The ADMV8913-EP has three modes of operation: parallel, SPI write, and SPI fast latch. Parallel mode is used to bypass the SPI to allow the filters to be programmed directly using the HPF_B3 to HPF_B0 and LPF_B3 to LPF_B0 logic inputs. To select parallel mode, set the PS pin low. Otherwise, set the PS pin high to enable the SPI for use with SPI write or SPI fast latch mode.

SPI write mode is the normal operating mode, whereas SPI fast latch mode is used to sequence through the on-chip lookup table (LUT) using the internal state machine. To select SPI write mode, set the PS pin high and the SFL pin low. For operation in SPI fast latch mode, program the on-chip LUT and fast latch parameters with the PS pin high and the SFL pin low, and then bring the SFL pin high to enter this mode. Figure 19 shows a simplified representation of the parallel logic and SPI with the register map and internal state machine.

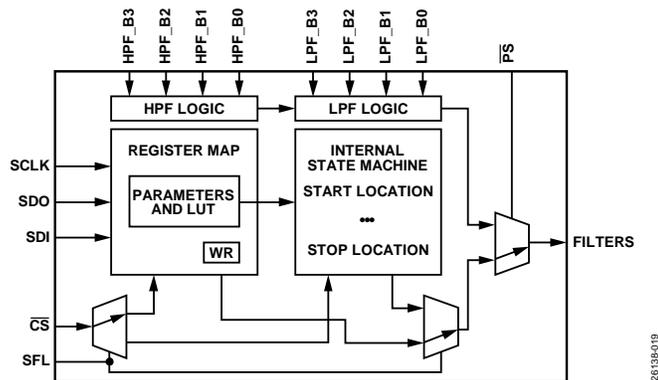

Figure 19. Simplified Interface and Logic Diagram

PARALLEL MODE

Parallel mode uses the HPF_B3 to HPF_B0 and LPF_B3 to LPF_B0 logic inputs to set the state of the HPF and the LPF. While in parallel mode, there are two types of logic operations, synchronous and asynchronous. For synchronous operation, the state on the HPF_B3 to HPF_B0 and LPF_B3 to LPF_B0 logic inputs is only latched to the HPF and LPF on the rising edge of the CS pin. For asynchronous operation, the CS pin is held high and then any change to the HPF_B3 to HPF_B0 and LPF_B3 to LPF_B0 logic inputs asynchronously propagates to the HPF and LPF.

SPI WRITE MODE

SPI write mode uses Register 0x020 (WR) to set the state of the HPF and the LPF that correspond to the HPF_WR and LPF_WR bit fields, respectively. See the Register Details section for a visual representation of Register 0x020 and its corresponding bit fields.

FILTER SETTINGS

The HPF and LPF each contain 16 states (4 bits). A value of zero corresponds to setting the f_{3dB} of the filter to its lowest possible frequency. Conversely, a value of 15 corresponds to setting the f_{3dB} of the filter to its highest possible frequency.

SPI FAST LATCH MODE

The ADMV8913-EP has a 128 state LUT and an internal state machine that is useful for quickly changing filter states in SPI fast latch mode. When the SFL pin is high, SPI fast latch mode enables, and the internal state machine sequences on each rising edge of the CS pin.

The LUT has 128 indices, LUT0 through LUT127 (Register 0x100 through Register 0x17F). Each index consists of the same type of parameters as those of SPI write mode.

The functionality of the internal state machine is such that on each rising edge of the CS pin, the internal state machine sequences a pointer based on the programmed direction. The internal state machine has the following parameters:

- FAST_LATCH_STOP (Register 0x011)
- FAST_LATCH_START (Register 0x012)
- FAST_LATCH_DIRECTION (Register 0x013)
- FAST_LATCH_STATE (Register 0x014)

The FAST_LATCH_STATE is the next LUT indices that is selected on the next rising edge of the CS pin. The FAST_LATCH_STATE is considered the internal pointer location.

When the FAST_LATCH_DIRECTION bit is set to zero, the sequencing direction is incremental. When the FAST_LATCH_DIRECTION bit is set to one, the sequencing direction is decremental.

The FAST_LATCH_START and FAST_LATCH_STOP bits set the start and stop location, respectively. For incremental direction, the internal state machine sequences from the start location to the stop location and then rolls over to the start location. For the decremental direction, the sequence is from the stop location to the start location and then rolls over to the stop location.

The FAST_LATCH_STATE internal pointer is set to the values stored in FAST_LATCH_START for the incremental direction. For the decremental direction, the internal pointer is to the values stored in FAST_LATCH_STOP. For this transaction to occur, one rising edge of the CS pin is necessary. By nature, this occurs during a SPI transaction in SPI write mode. However, when exiting SPI fast latch mode (SFL pin brought low), toggle the CS pin low then high or perform a SPI transaction so that the FAST_LATCH_STATE refreshes to either the start or stop location accordingly.

SPI STREAMING

In general, there are two types of SPI streaming transactions, Endian register ascending order and Endian register descending order. The ADMV8913-EP supports only the ascending order. To enable SPI streaming with Endian register ascending order, program Register 0x00 to a value of 0x3C.

For SPI streaming to the LUT, Register 0x100 to Register 0x17F (recommended), the transaction points to Register 0x100 and streams out 128 bytes of data. The transaction is 1040 bits in total (R/W bit + 15 bits address + 1024 bits data).

CHIP RESET

There are two methods that can reset the ADMV8913-EP registers to their default power-on state, a hard reset and a soft reset. The hard reset utilizes the $\overline{\text{RST}}$ pin, and the soft reset utilizes Register 0x000.

To perform a hard reset, momentarily bring the $\overline{\text{RST}}$ pin low and then high. See Figure 2 for the minimum required duration time for the $\overline{\text{RST}}$ pin to be low.

To perform a soft reset, program Register 0x000 to a value of 0x81. This action sets the SOFTRESET and SOFTRESET_ bits high to initiate the reset. The SOFTRESET and SOFTRESET_ bits are self resetting once the reset operation completes.

Regardless of the reset method used, it is recommended to perform the following after the chip resets:

- Program Register 0x000 to 0x3C to enable the SDO pin and allow SPI streaming with Endian ascending order.
- Read back all registers on the chip.

APPLICATIONS INFORMATION

PRINTED CIRCUIT BOARD (PCB) DESIGN GUIDELINES

The PCB used to implement the ADMV8913-EP must use a high quality dielectric material between the top metallization layer and internal ground layer, such as the Rogers 4003 or the Rogers 4350. All other dielectric layers of the PCB can be standard material, such as the Isola 370HR. The characteristic impedance

of the transmission lines to the RF1 and RF2 pins of the ADMV8913-EP must be carefully controlled to 50 Ω to ensure optimal RF performance. Connect the GND pins and exposed pad of the ADMV8913-EP directly to the ground plane of the PCB. Use a sufficient number of via holes to connect the top and bottom ground planes of the PCB.

PROGRAMMING FLOW CHART

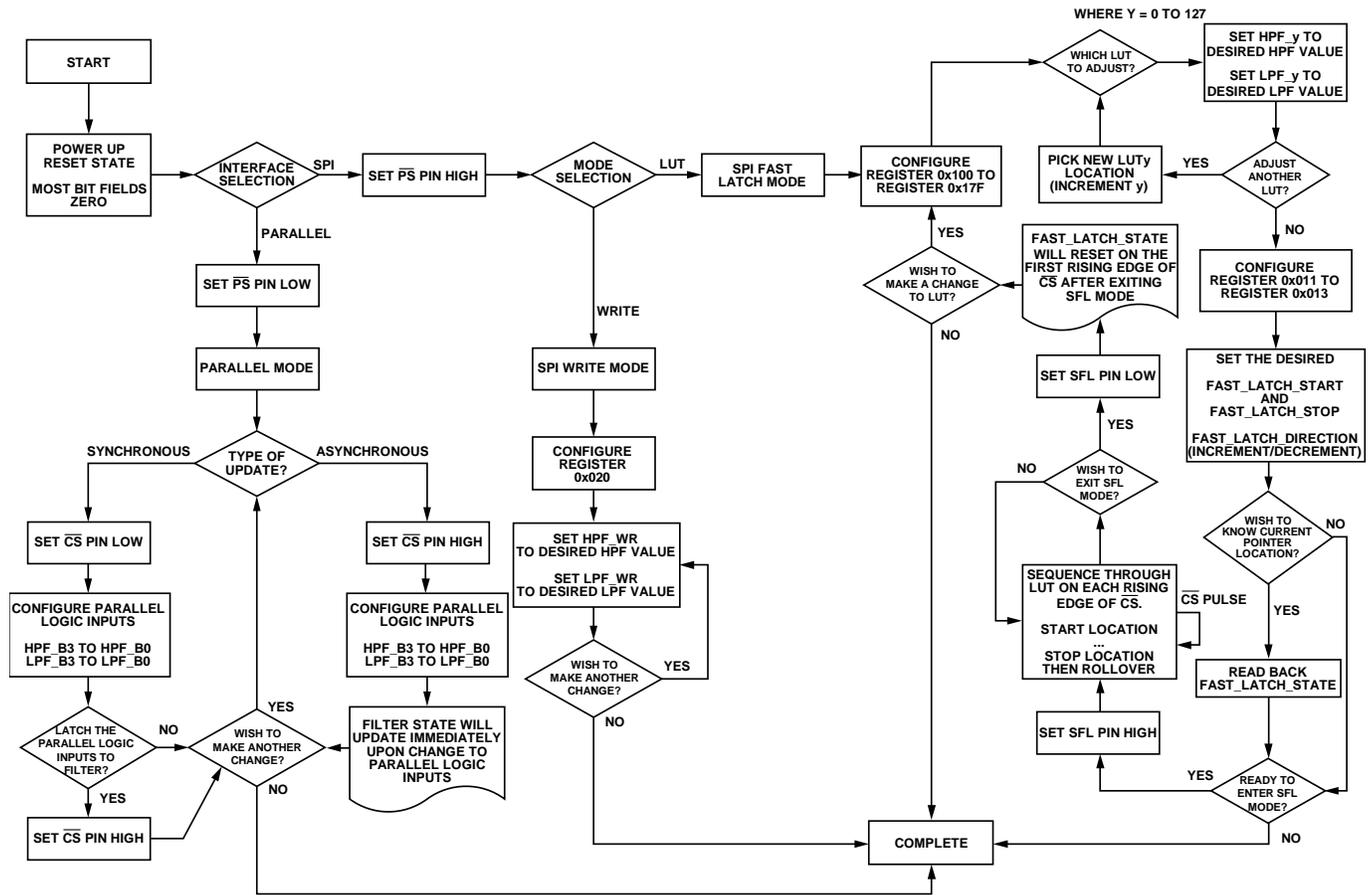

Figure 20. Programming Flowchart

26138-020

REGISTER SUMMARY

Table 6. Register Summary

Reg	Name	Bits	Bit 7	Bit 6	Bit 5	Bit 4	Bit 3	Bit 2	Bit 1	Bit 0	Reset	R/W	
0x000	ADI_SPI_CONFIG_A	[7:0]	SOFTRESET_	LSB_FIRST_	ENDIAN_	SDOACTIVE_	SDOACTIVE	ENDIAN	LSB_FIRST	SOFTRESET	0x00	R/W	
0x001	ADI_SPI_CONFIG_B	[7:0]	SINGLE_INSTRUCTION	CSB_STALL	MASTER_SLAVE_RB	RESERVED				MASTER_SLAVE_TRANSFER	0x00	R/W	
0x003	CHIPTYPE	[7:0]	CHIPTYPE									0x01	R
0x004	PRODUCT_ID_L	[7:0]	PRODUCT_ID_L									0x13	R
0x005	PRODUCT_ID_H	[7:0]	PRODUCT_ID_H									0x89	R
0x011	FAST_LATCH_STOP	[7:0]	RESERVED	FAST_LATCH_STOP								0x7F	R/W
0x012	FAST_LATCH_START	[7:0]	RESERVED	FAST_LATCH_START								0x00	R/W
0x013	FAST_LATCH_DIRECTION	[7:0]	RESERVED							FAST_LATCH_DIRECTION	0x00	R/W	
0x014	FAST_LATCH_STATE	[7:0]	RESERVED	FAST_LATCH_STATE								0x00	R
0x020	WR	[7:0]	HPF_WR				LPF_WR				0x00	R/W	
0x100	LUT0	[7:0]	HPF_0				LPF_0				0x00	R/W	
0x101	LUT1	[7:0]	HPF_1				LPF_1				0x00	R/W	
0x102	LUT2	[7:0]	HPF_2				LPF_2				0x00	R/W	
0x103	LUT3	[7:0]	HPF_3				LPF_3				0x00	R/W	
0x104	LUT4	[7:0]	HPF_4				LPF_4				0x00	R/W	
0x105	LUT5	[7:0]	HPF_5				LPF_5				0x00	R/W	
0x106	LUT6	[7:0]	HPF_6				LPF_6				0x00	R/W	
0x107	LUT7	[7:0]	HPF_7				LPF_7				0x00	R/W	
0x108	LUT8	[7:0]	HPF_8				LPF_8				0x00	R/W	
0x109	LUT9	[7:0]	HPF_9				LPF_9				0x00	R/W	
0x10A	LUT10	[7:0]	HPF_10				LPF_10				0x00	R/W	
0x10B	LUT11	[7:0]	HPF_11				LPF_11				0x00	R/W	
0x10C	LUT12	[7:0]	HPF_12				LPF_12				0x00	R/W	
0x10D	LUT13	[7:0]	HPF_13				LPF_13				0x00	R/W	
0x10E	LUT14	[7:0]	HPF_14				LPF_14				0x00	R/W	
0x10F	LUT15	[7:0]	HPF_15				LPF_15				0x00	R/W	
0x110	LUT16	[7:0]	HPF_16				LPF_16				0x00	R/W	
0x111	LUT17	[7:0]	HPF_17				LPF_17				0x00	R/W	
0x112	LUT18	[7:0]	HPF_18				LPF_18				0x00	R/W	
0x113	LUT19	[7:0]	HPF_19				LPF_19				0x00	R/W	
0x114	LUT20	[7:0]	HPF_20				LPF_20				0x00	R/W	
0x115	LUT21	[7:0]	HPF_21				LPF_21				0x00	R/W	
0x116	LUT22	[7:0]	HPF_22				LPF_22				0x00	R/W	
0x117	LUT23	[7:0]	HPF_23				LPF_23				0x00	R/W	
0x118	LUT24	[7:0]	HPF_24				LPF_24				0x00	R/W	
0x119	LUT25	[7:0]	HPF_25				LPF_25				0x00	R/W	
0x11A	LUT26	[7:0]	HPF_26				LPF_26				0x00	R/W	
0x11B	LUT27	[7:0]	HPF_27				LPF_27				0x00	R/W	
0x11C	LUT28	[7:0]	HPF_28				LPF_28				0x00	R/W	
0x11D	LUT29	[7:0]	HPF_29				LPF_29				0x00	R/W	
0x11E	LUT30	[7:0]	HPF_30				LPF_30				0x00	R/W	
0x11F	LUT31	[7:0]	HPF_31				LPF_31				0x00	R/W	
0x120	LUT32	[7:0]	HPF_32				LPF_32				0x00	R/W	
0x121	LUT33	[7:0]	HPF_33				LPF_33				0x00	R/W	
0x122	LUT34	[7:0]	HPF_34				LPF_34				0x00	R/W	
0x123	LUT35	[7:0]	HPF_35				LPF_35				0x00	R/W	
0x124	LUT36	[7:0]	HPF_36				LPF_36				0x00	R/W	
0x125	LUT37	[7:0]	HPF_37				LPF_37				0x00	R/W	
0x126	LUT38	[7:0]	HPF_38				LPF_38				0x00	R/W	
0x127	LUT39	[7:0]	HPF_39				LPF_39				0x00	R/W	
0x128	LUT40	[7:0]	HPF_40				LPF_40				0x00	R/W	
0x129	LUT41	[7:0]	HPF_41				LPF_41				0x00	R/W	
0x12A	LUT42	[7:0]	HPF_42				LPF_42				0x00	R/W	
0x12B	LUT43	[7:0]	HPF_43				LPF_43				0x00	R/W	

Reg	Name	Bits	Bit 7	Bit 6	Bit 5	Bit 4	Bit 3	Bit 2	Bit 1	Bit 0	Reset	R/W
0x12C	LUT44	[7:0]		HPF_44					LPF_44		0x00	R/W
0x12D	LUT45	[7:0]		HPF_45					LPF_45		0x00	R/W
0x12E	LUT46	[7:0]		HPF_46					LPF_46		0x00	R/W
0x12F	LUT47	[7:0]		HPF_47					LPF_47		0x00	R/W
0x130	LUT48	[7:0]		HPF_48					LPF_48		0x00	R/W
0x131	LUT49	[7:0]		HPF_49					LPF_49		0x00	R/W
0x132	LUT50	[7:0]		HPF_50					LPF_50		0x00	R/W
0x133	LUT51	[7:0]		HPF_51					LPF_51		0x00	R/W
0x134	LUT52	[7:0]		HPF_52					LPF_52		0x00	R/W
0x135	LUT53	[7:0]		HPF_53					LPF_53		0x00	R/W
0x136	LUT54	[7:0]		HPF_54					LPF_54		0x00	R/W
0x137	LUT55	[7:0]		HPF_55					LPF_55		0x00	R/W
0x138	LUT56	[7:0]		HPF_56					LPF_56		0x00	R/W
0x139	LUT57	[7:0]		HPF_57					LPF_57		0x00	R/W
0x13A	LUT58	[7:0]		HPF_58					LPF_58		0x00	R/W
0x13B	LUT59	[7:0]		HPF_59					LPF_59		0x00	R/W
0x13C	LUT60	[7:0]		HPF_60					LPF_60		0x00	R/W
0x13D	LUT61	[7:0]		HPF_61					LPF_61		0x00	R/W
0x13E	LUT62	[7:0]		HPF_62					LPF_62		0x00	R/W
0x13F	LUT63	[7:0]		HPF_63					LPF_63		0x00	R/W
0x140	LUT064	[7:0]		HPF_64					LPF_64		0x00	R/W
0x141	LUT065	[7:0]		HPF_65					LPF_65		0x00	R/W
0x142	LUT066	[7:0]		HPF_66					LPF_66		0x00	R/W
0x143	LUT067	[7:0]		HPF_67					LPF_67		0x00	R/W
0x144	LUT068	[7:0]		HPF_68					LPF_68		0x00	R/W
0x145	LUT069	[7:0]		HPF_69					LPF_69		0x00	R/W
0x146	LUT070	[7:0]		HPF_70					LPF_70		0x00	R/W
0x147	LUT071	[7:0]		HPF_71					LPF_71		0x00	R/W
0x148	LUT072	[7:0]		HPF_72					LPF_72		0x00	R/W
0x149	LUT073	[7:0]		HPF_73					LPF_73		0x00	R/W
0x14A	LUT074	[7:0]		HPF_74					LPF_74		0x00	R/W
0x14B	LUT075	[7:0]		HPF_75					LPF_75		0x00	R/W
0x14C	LUT076	[7:0]		HPF_76					LPF_76		0x00	R/W
0x14D	LUT077	[7:0]		HPF_77					LPF_77		0x00	R/W
0x14E	LUT078	[7:0]		HPF_78					LPF_78		0x00	R/W
0x14F	LUT079	[7:0]		HPF_79					LPF_79		0x00	R/W
0x150	LUT080	[7:0]		HPF_80					LPF_80		0x00	R/W
0x151	LUT081	[7:0]		HPF_81					LPF_81		0x00	R/W
0x152	LUT082	[7:0]		HPF_82					LPF_82		0x00	R/W
0x153	LUT083	[7:0]		HPF_83					LPF_83		0x00	R/W
0x154	LUT084	[7:0]		HPF_84					LPF_84		0x00	R/W
0x155	LUT085	[7:0]		HPF_85					LPF_85		0x00	R/W
0x156	LUT086	[7:0]		HPF_86					LPF_86		0x00	R/W
0x157	LUT087	[7:0]		HPF_87					LPF_87		0x00	R/W
0x158	LUT088	[7:0]		HPF_88					LPF_88		0x00	R/W
0x159	LUT089	[7:0]		HPF_89					LPF_89		0x00	R/W
0x15A	LUT090	[7:0]		HPF_90					LPF_90		0x00	R/W
0x15B	LUT091	[7:0]		HPF_91					LPF_91		0x00	R/W
0x15C	LUT092	[7:0]		HPF_92					LPF_92		0x00	R/W
0x15D	LUT093	[7:0]		HPF_93					LPF_93		0x00	R/W
0x15E	LUT094	[7:0]		HPF_94					LPF_94		0x00	R/W
0x15F	LUT095	[7:0]		HPF_95					LPF_95		0x00	R/W
0x160	LUT096	[7:0]		HPF_96					LPF_96		0x00	R/W
0x161	LUT097	[7:0]		HPF_97					LPF_97		0x00	R/W
0x162	LUT098	[7:0]		HPF_98					LPF_98		0x00	R/W
0x163	LUT099	[7:0]		HPF_99					LPF_99		0x00	R/W
0x164	LUT100	[7:0]		HPF_100					LPF_100		0x00	R/W
0x165	LUT101	[7:0]		HPF_101					LPF_101		0x00	R/W
0x166	LUT102	[7:0]		HPF_102					LPF_102		0x00	R/W
0x167	LUT103	[7:0]		HPF_103					LPF_103		0x00	R/W
0x168	LUT104	[7:0]		HPF_104					LPF_104		0x00	R/W

Reg	Name	Bits	Bit 7	Bit 6	Bit 5	Bit 4	Bit 3	Bit 2	Bit 1	Bit 0	Reset	R/W
0x169	LUT105	[7:0]		HPF_105				LPF_105			0x00	R/W
0x16A	LUT106	[7:0]		HPF_106				LPF_106			0x00	R/W
0x16B	LUT107	[7:0]		HPF_107				LPF_107			0x00	R/W
0x16C	LUT108	[7:0]		HPF_108				LPF_108			0x00	R/W
0x16D	LUT109	[7:0]		HPF_109				LPF_109			0x00	R/W
0x16E	LUT110	[7:0]		HPF_110				LPF_110			0x00	R/W
0x16F	LUT111	[7:0]		HPF_111				LPF_111			0x00	R/W
0x170	LUT112	[7:0]		HPF_112				LPF_112			0x00	R/W
0x171	LUT113	[7:0]		HPF_113				LPF_113			0x00	R/W
0x172	LUT114	[7:0]		HPF_114				LPF_114			0x00	R/W
0x173	LUT115	[7:0]		HPF_115				LPF_115			0x00	R/W
0x174	LUT116	[7:0]		HPF_116				LPF_116			0x00	R/W
0x175	LUT117	[7:0]		HPF_117				LPF_117			0x00	R/W
0x176	LUT118	[7:0]		HPF_118				LPF_118			0x00	R/W
0x177	LUT119	[7:0]		HPF_119				LPF_119			0x00	R/W
0x178	LUT120	[7:0]		HPF_120				LPF_120			0x00	R/W
0x179	LUT121	[7:0]		HPF_121				LPF_121			0x00	R/W
0x17A	LUT122	[7:0]		HPF_122				LPF_122			0x00	R/W
0x17B	LUT123	[7:0]		HPF_123				LPF_123			0x00	R/W
0x17C	LUT124	[7:0]		HPF_124				LPF_124			0x00	R/W
0x17D	LUT125	[7:0]		HPF_125				LPF_125			0x00	R/W
0x17E	LUT126	[7:0]		HPF_126				LPF_126			0x00	R/W
0x17F	LUT127	[7:0]		HPF_127				LPF_127			0x00	R/W

REGISTER DETAILS

Register: 0x000, Reset: 0x00, Name: ADI_SPI_CONFIG_A

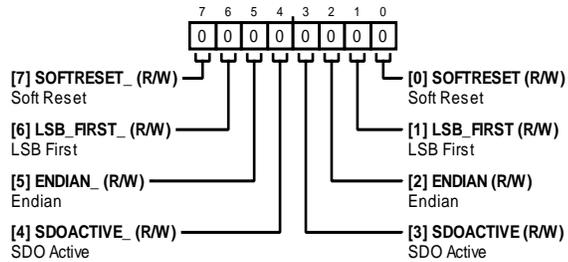

Table 7. Bit Descriptions for ADI_SPI_CONFIG_A

Bits	Bit Name	Description	Reset	Access
7	SOFTRESET_	Soft Reset 0: reset asserted 1: reset not asserted	0x0	R/W
6	LSB_FIRST_	LSB First 0: LSB first 1: MSB first	0x0	R/W
5	ENDIAN_	Endian 0: little Endian 1: big Endian	0x0	R/W
4	SDOACTIVE_	SDO Active 0: SDO inactive 1: SDO active	0x0	R/W
3	SDOACTIVE	SDO Active 0: SDO inactive 1: SDO active	0x0	R/W
2	ENDIAN	Endian 0: little Endian 1: big Endian	0x0	R/W
1	LSB_FIRST	LSB First 0: LSB first 1: MSB first	0x0	R/W
0	SOFTRESET	Soft Reset 0: reset asserted 1: reset not asserted	0x0	R/W

Register: 0x001, Reset: 0x00, Name: ADI_SPI_CONFIG_B

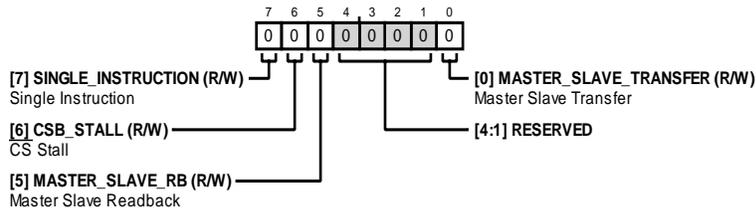

Table 8. Bit Descriptions for ADI_SPI_CONFIG_B

Bits	Bit Name	Description	Reset	Access
7	SINGLE_INSTRUCTION	Single Instruction 0: enable streaming 1: disable streaming regardless of \overline{CS}	0x0	R/W
6	CSB_STALL	\overline{CS} Stall	0x0	R/W
5	MASTER_SLAVE_RB	Master Slave Readback	0x0	R/W
[4:1]	RESERVED	Reserved	0x0	R
0	MASTER_SLAVE_TRANSFER	Master Slave Transfer	0x0	R/W

Register: 0x003, Reset: 0x01, Name: CHIPTYPE

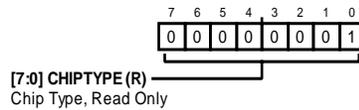

Table 9. Bit Descriptions for CHIPTYPE

Bits	Bit Name	Description	Reset	Access
[7:0]	CHIPTYPE	Chip Type, Read Only	0x1	R

Register: 0x004, Reset: 0x13, Name: PRODUCT_ID_L

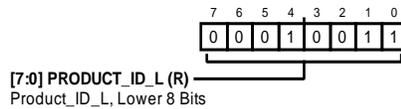

Table 10. Bit Descriptions for PRODUCT_ID_L

Bits	Bit Name	Description	Reset	Access
[7:0]	PRODUCT_ID_L	Product_ID_L, Lower 8 Bits	0x13	R

Register: 0x005, Reset: 0x89, Name: PRODUCT_ID_H

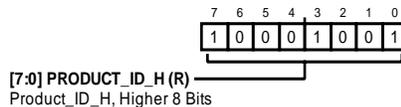

Table 11. Bit Descriptions for PRODUCT_ID_H

Bits	Bit Name	Description	Reset	Access
[7:0]	PRODUCT_ID_H	Product_ID_H, Higher 8 Bits	0x89	R

Register: 0x011, Reset: 0x7F, Name: FAST_LATCH_STOP

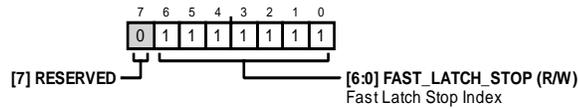

Table 12. Bit Descriptions for FAST_LATCH_STOP

Bits	Bit Name	Description	Reset	Access
7	RESERVED	Reserved.	0x0	R
[6:0]	FAST_LATCH_STOP	Fast Latch Stop Index. Sets the stop index within the fast latch LUT.	0x7F	R/W

Register: 0x012, Reset: 0x00, Name: FAST_LATCH_START

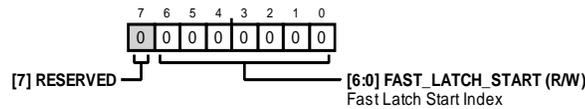

Table 13. Bit Descriptions for FAST_LATCH_START

Bits	Bit Name	Description	Reset	Access
7	RESERVED	Reserved.	0x0	R
[6:0]	FAST_LATCH_START	Fast Latch Start Index. Sets the start index within the fast latch LUT.	0x0	R/W

Register: 0x013, Reset: 0x00, Name: FAST_LATCH_DIRECTION

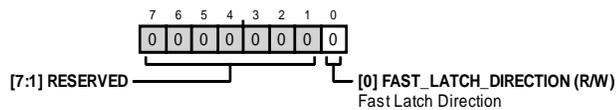

Table 14. Bit Descriptions for FAST_LATCH_DIRECTION

Bits	Bit Name	Description	Reset	Access
[7:1]	RESERVED	Reserved.	0x0	R
0	FAST_LATCH_DIRECTION	Fast Latch Direction. Determines which direction to sequence within the fast latch LUT. 0: increment. 1: decrement.	0x0	R/W

Register: 0x014, Reset: 0x00, Name: FAST_LATCH_STATE

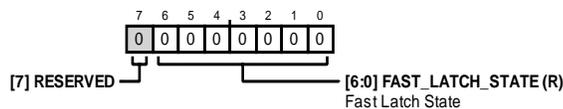

Table 15. Bit Descriptions for FAST_LATCH_STATE

Bits	Bit Name	Description	Reset	Access
7	RESERVED	Reserved.	0x0	R
[6:0]	FAST_LATCH_STATE	Fast Latch State. Reads back the internal state machine pointer.	0x0	R

Register: 0x020, Reset: 0x00, Name: WR

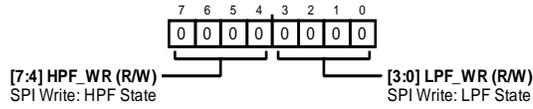

Table 16. Bit Descriptions for WR

Bits	Bit Name	Description	Reset	Access
[7:4]	HPF_WR	SPI Write: HPF State	0x0	R/W
[3:0]	LPF_WR	SPI Write: LPF State	0x0	R/W

Register: 0x100, Reset: 0x00, Name: LUT0

Note that the LUT1 to LUT127 bit field functionality (Register 0x101 to Register 0x17F) is identical to LUT0 bit field functionality (Register 0x100). See the Register Summary section and Table 6 for the register address information.

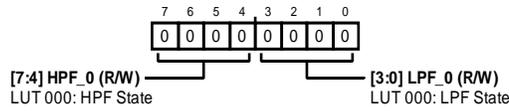

Table 17. Bit Descriptions for LUT0

Bits	Bit Name	Description	Reset	Access
[7:4]	HPF_0	LUT 000: HPF State	0x0	R/W
[3:0]	LPF_0	LUT 000: LPF State	0x0	R/W

X-ON Electronics

Largest Supplier of Electrical and Electronic Components

Click to view similar products for [Active Filters](#) category:

Click to view products by [Analog Devices](#) manufacturer:

Other Similar products are found below :

[VEMI256A-SD2-G4-08](#) [HMC894LP5ETR](#) [HMC896LP4ETR](#) [HMC891LP5ETR](#) [MAX7491CEE+](#) [MAX7413CUA+](#) [MAX7411CUA+](#)
[MAX281AEWE+](#) [MAX280EPA+](#) [MAX274AENG+](#) [LTC1064-3CSW#PBF](#) [LTC1060ACN#PBF](#) [LTC1069-1IS8#PBF](#) [LTC1164CSW#PBF](#)
[LTC1164-6CSW#PBF](#) [LTC1064-2CSW#PBF](#) [LTC1569CS8-7#PBF](#) [LTC1164ACSW#PBF](#) [LTC1067-50CS#PBF](#) [LTC1164-6CN#PBF](#)
[LTC1059CN#PBF](#) [LTC1069-1CN8#PBF](#) [LTC1069-7IS8#PBF](#) [LTC1069-6CS8#PBF](#) [LTC1562IG-2#PBF](#) [LTC1164-5CSW#PBF](#) [LTC1566-](#)
[1CS8#PBF](#) [LTC1064-7CN#PBF](#) [LTC1063CN8#PBF](#) [LTC1062CN8#PBF](#) [LTC6603IUF#PBF](#) [LTC1061ACN#PBF](#) [LTC1061CN#PBF](#)
[LTC1264CN#PBF](#) [LTC1562ACG#PBF](#) [LTC1562AIG#PBF](#) [LTC1164-7CSW#PBF](#) [LTC1064-3CN#PBF](#) [HMC890ALP5E](#) [HMC892ALP5E](#)
[HMC891ALP5E](#) [HMC882ALP5E](#) [HMC881ALP5E](#) [ADMV8420ACPZ](#) [ADMV8432ACPZ](#) [HMC881LP5ETR](#) [HMC882LP5ETR](#)
[HMC1000LP5ETR](#) [HMC900LP5E](#) [LTC1068IN#PBF](#)