

Evaluating the **ADP1071-1** Isolated Synchronous Flyback Controller with Integrated *iCoupler*

FEATURES

- Full support evaluation kit for the **ADP1071-1**
- 15 W multioutput flyback topology
- +24 V, +5.5 V, and -15 V output voltage (V_{DC})
- Light load mode (LLM) operation
- Dedicated internal primary and secondary side MOSFET drivers
- External reference signal tracking
- Precision enabled undervoltage lockout with hysteresis
- Short-circuit, output overvoltage, cycle by cycle input overcurrent, and overtemperature protection
- Frequency synchronization
- Soft start and soft stop functionality

EVALUATION KIT CONTENTS

ADP1071-1EVALZ

EQUIPMENT NEEDED

- DC power supply capable of 18 V_{DC} to 32 V_{DC} , 1 A output current capability of the supply
- Electronic load capable of 15 W, 0 V to 30 V rating capability of the load
- Oscilloscope capable of ≥ 500 MHz bandwidth, 2 channels to 4 channels
- Precision digital multimeter (HP 34401 or equivalent)

GENERAL DESCRIPTION

The ADP1071-1EVALZ allows users to evaluate the **ADP1071-1** in flyback topology.

The evaluation board is set up to act as an isolated power supply solution that incorporates three output voltages (+5.5 V, +24 V, and -15 V) at a total rated power of 15 W. The evaluation board also provides 5 kV isolation in compact form factor, making it suitable for industrial applications, which usually have a variety of voltage rails.

Complete information about the **ADP1071-1** is available in the **ADP1071-1/ADP1071-2** data sheet. Consult the **ADP1071-1/ADP1071-2** data sheet in conjunction with this user guide when using the evaluation board.

DIGITAL PICTURES OF THE EVALUATION BOARD

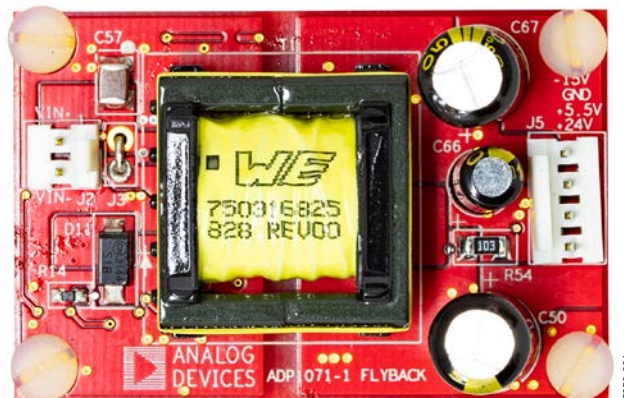

Figure 1. ADP1071-1EVALZ Top

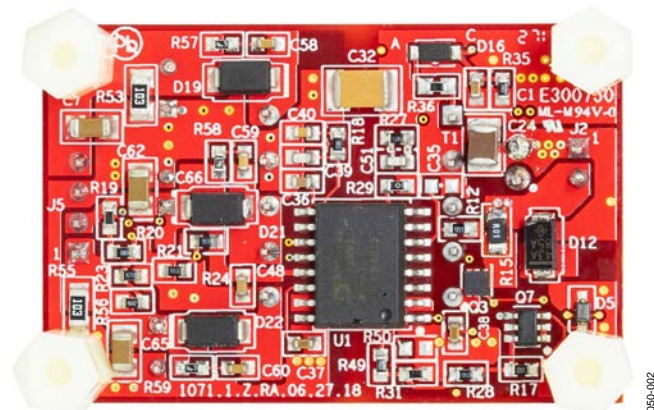

Figure 2. ADP1071-1EVALZ Bottom

TABLE OF CONTENTS

Features	1	Powering Up.....	4
Evaluation Kit Contents.....	1	ADP1071-1EVALZ Dimensions	4
Equipment Needed.....	1	Evaluating the ADP1071-1EVALZ Board	5
General Description	1	Startup.....	5
Digital Pictures of the Evaluation Board	1	Cross Regulation	5
Revision History	2	Control Loop Gain.....	6
Evaluation Board Overview	3	Voltage and Current Stress.....	6
Power Train Overview	3	Efficiency	7
Transformer.....	3	Thermal Performance.....	7
Connectors	3	Evaluation Board Schematic and Artwork.....	8
Caution	3	Ordering Information.....	11
Evaluation Board Hardware.....	4	Bill of Materials.....	11
Evaluation Board Configurations	4		

REVISION HISTORY

8/2018—Revision 0: Initial Version

EVALUATION BOARD OVERVIEW

This evaluation board features the ADP1071-1 in a dc-to-dc switching power supply in flyback topology with multiple outputs in a compact form factor.

The ADP1071-1EVALZ circuit is designed to provide +5.5 V, +24 V, and -15 V at a total rated power of 15 W from a dc input voltage source of 18 V_{DC} to 32 V_{DC}. To maximize efficiency at light load conditions, the ADP1071-1 operates at a switching frequency of 50 kHz. The switching frequency minimizes switching losses of the converter and is high enough to keep the transformer size small.

POWER TRAIN OVERVIEW

The ADP1071-1EVALZ is shown in Figure 1 and Figure 2. The circuit components on the ADP1071-1EVALZ are described as follows:

- The input filter consists of a capacitor bank including Capacitor 24 (C24) to Capacitor 57 (C57).
- Q3 is an N channel, metal-oxide semiconductor field effect transistor (MOSFET) used as the main switch on the primary side.
- Transformer T1 provides isolation.
- The secondary side of the circuitry has three windings followed by one rectifying diode and one resistor/capacitor (RC) snubber.
- The output filter consists of two capacitors for each of the rails. These capacitors include C60 and C65 at the 24 V rail, C62 and C66 at the 5.5 V rail, and C7 and C67 at the -15 V rail.

The snubber for the main switch is composed of D11 and D12.

The ADP1071-1 flyback controller (U1) is the power controller. The power controller integrates gate drive for driving the primary switch and synchronous rectifier based on the Analog Devices, Inc., iCoupler® technology.

During startup, U1 is powered by the J2 or J4 input via an external start-up circuit (Q7, R17, D5, or C38). When switching and power conversion starts, the auxiliary winding provides power

to the VREG1 pin. R15 is the sense resistor that senses the primary current.

TRANSFORMER

The transformer has 10 pins and five windings, including primary winding (Pin 4 to Pin 3), auxiliary winding (Pin 2 to Pin 1), and three output windings (Pin 6 to Pin 7, Pin 8 to Pin 9, and Pin 9 to Pin 10).

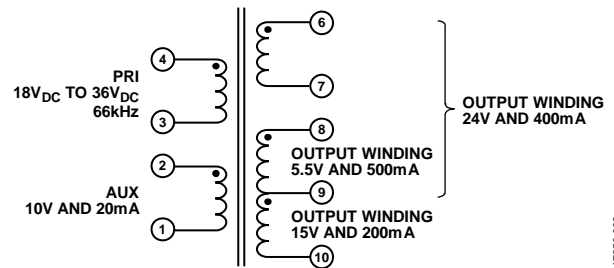

Figure 3. Transformer Diagram

CONNECTORS

The connections to the ADP1071-1EVALZ are shown in Table 1.

Table 1. Evaluation Board Connections

Connector	Pin Function
J2	Pin 1, VIN+, dc input
	Pin 2, VIN-, ground return for dc input
J5	Pin 1, 24 V _{DC} output
	Pin 2, 5.5 V _{DC} output
	Pin 3, GND, return for dc output
	Pin 4, -15 V _{DC} output

CAUTION

The ADP1071-1EVALZ uses high voltages. Take extreme caution, especially on the primary side, to ensure safety. It is advised to switch off the evaluation board when not in use. Use a current limited, isolated dc source at the input.

EVALUATION BOARD HARDWARE

EVALUATION BOARD CONFIGURATIONS

The ADP1071-1EVALZ is preconfigured with the default settings to operate the power supply at the rated load. No additional configuration is necessary. Replace J3 with at least an AWG22 wire to monitor the primary current.

POWERING UP

To power up the ADP1071-1EVALZ, use the following steps:

1. Connect a dc source (voltage range of 18 V_{DC} to 32 V_{DC}) at the input terminals and electronic loads at the output terminals.
2. Connect voltmeters on the input terminals (VIN+ and VIN-) and output terminals (+24 V, +5.5 V, -15 V, and GND) separately.
3. Connect the voltage probes at different test pins. Use the differential probes and ensure the ground of the probes are isolated if the measurements are made on the primary and secondary side of the transformer (T1) simultaneously.
4. Set the electronic load to the maximum rating for each rail.
5. Turn on the dc source.

ADP1071-1EVALZ DIMENSIONS

Table 2 shows the dimensions of the ADP1071-1EVALZ evaluation board. The dimensions exclude standoff.

Table 2. Evaluation Board Dimensions

Dimension	Value (Inches)
Length	1.9
Width	1.25
Height	0.75 (excluding standoffs)

EVALUATING THE ADP1071-1EVALZ BOARD

Test points on the evaluation board allow the user to monitor output signals. The following sections provide descriptions of the typical results when evaluating the device in a multiflyback topology. The user can modify the operation of the device according to the ADP1071-1/ADP1071-2 data sheet as needed.

STARTUP

When the supply voltage is on, the output voltages ramp up smoothly. For details about two-stage soft start, refer to the ADP1071-1/ADP1071-2 data sheet. Figure 4 shows the startup under a no load condition, and Figure 5 shows the startup of a full load condition.

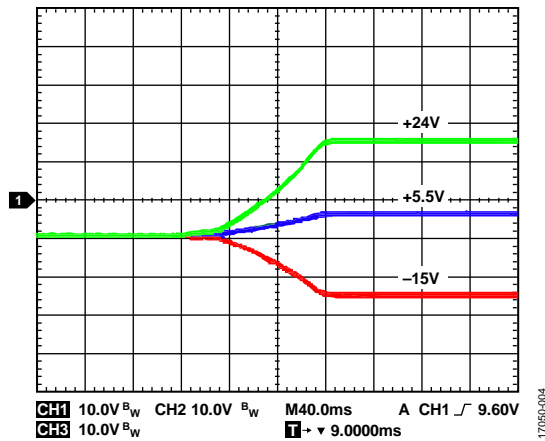

Figure 4. Startup at No Load

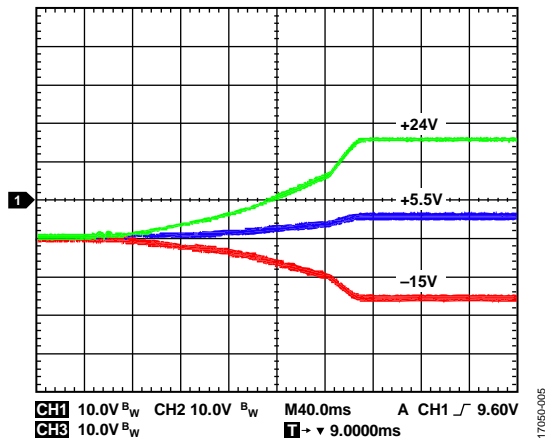

Figure 5. Startup at Full Load

To experiment with different soft start timings, see more details in the soft start section in the ADP1071-1/ADP1071-2 data sheet.

CROSS REGULATION

On the secondary side, the output voltage information of the 5.5 V rail and the 24 V rail are sensed by a voltage divider network and sent to the FB pin. These two voltages (5.5 V and 24 V) are partially regulated by a weightage ratio of 6:4. The -15 V rail is left quasi regulated due to its relatively low load current rating. The user can adjust the feedback weightage ratio

according to the regulation requirement and load rating to achieve the most optimal cross regulation among the three outputs. Figure 6 through Figure 9 show the cross regulation performance under different load conditions.

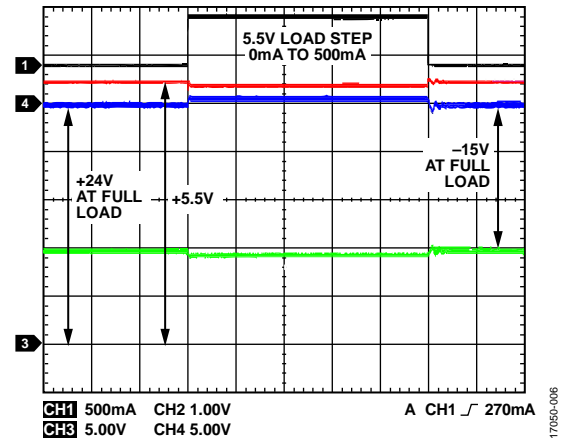

Figure 6. Cross Regulation with Load Step at a +5.5 V Rail When +24 V and -15 V Rails at Full Load

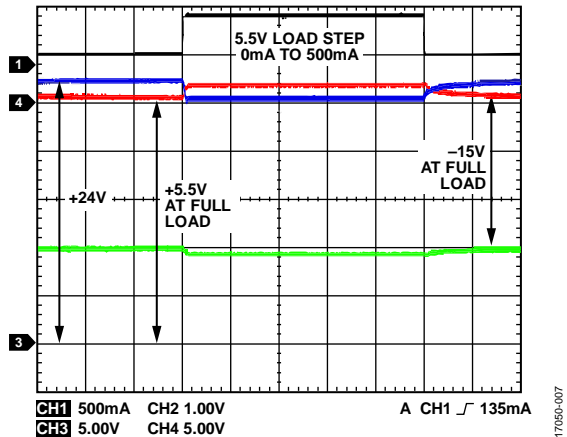

Figure 7. Cross Regulation with Load Step at a +24 V Rail When +5.5 V and -15 V Rails at Full Load

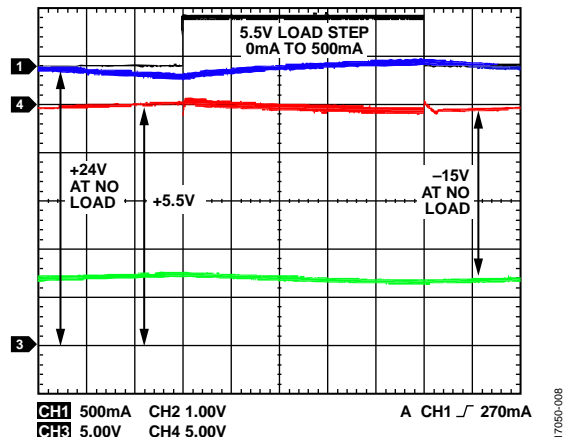

Figure 8. Cross Regulation with Load Step at a +5.5 V Rail When +24 V and -15 V Rails at No Load

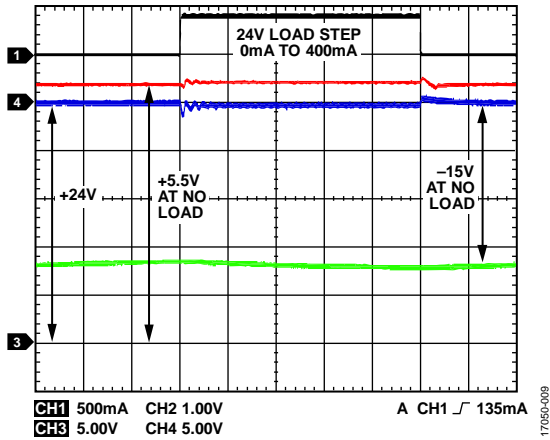

Figure 9. Cross Regulation with Load Step at a +24 V Rail When +5.5 V and -15 V Rails at No Load

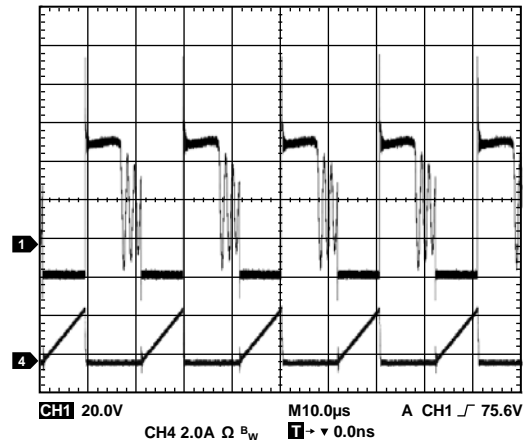

Figure 11. MOSFET Drain to Source Voltages at 32 V_{DC} Input and Full Load

CONTROL LOOP GAIN

The loop gain can be measured via a network analyzer. The small signal perturbation is injected at R19 and at the 5.5 V test points. Figure 10 shows the loop gain of the system.

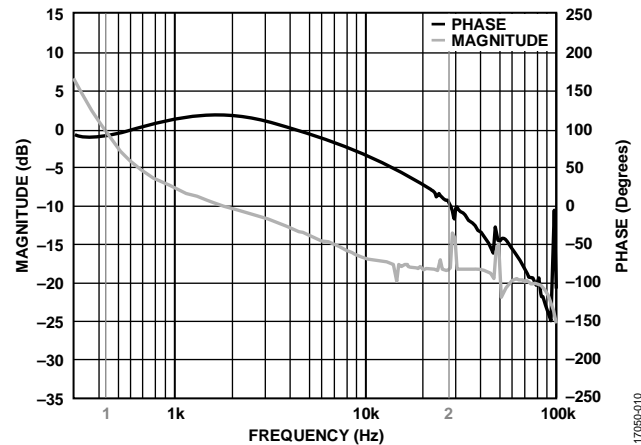

Figure 10. Loop Gain Measurement, Crossover Frequency = 432.33 Hz, Phase Margin = 91.07°, Gain Margin = 13.51 dB

VOLTAGE AND CURRENT STRESS

The drain to source voltage of the main switch is clamped by the transient voltage suppressor (TVS) diode on the evaluation board. The peak drain to source voltage occurs at the maximum input voltage. The drain to source voltages at full load are shown in Figure 11. The peak drain to source voltage is 114 V, and the peak primary current is 2.2 A.

The peak reverse voltage stress on the secondary diodes are measured in Figure 12 to Figure 14 under the same condition as in Figure 11. For +5.5 V, +24 V, and -15 V rails, the diode voltage stress is -19.5 V, -72.4 V, and +48 V, respectively.

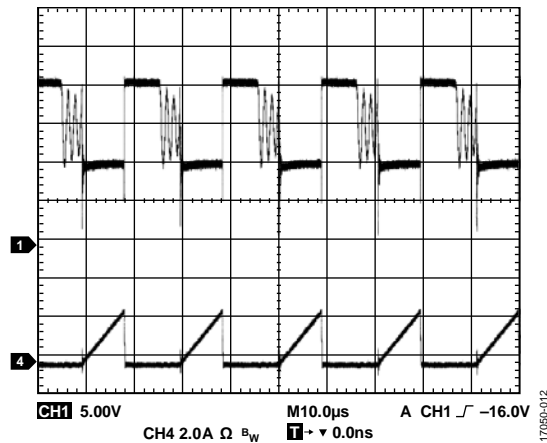

Figure 12. Peak Diode Voltage Stress on a 5.5 V Rail at 32 V_{DC} Input and Full Load

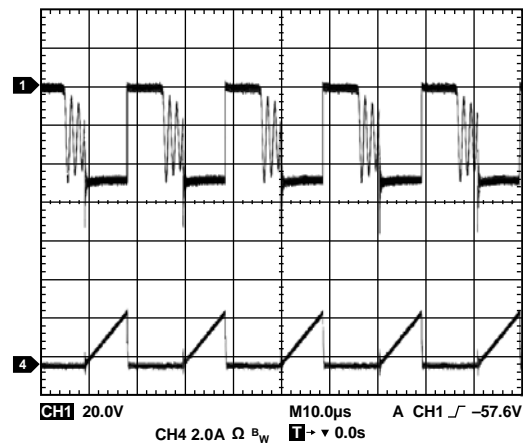

Figure 13. Peak Diode Voltage Stress on a 24 V Rail at 32 V_{DC} Input and Full Load

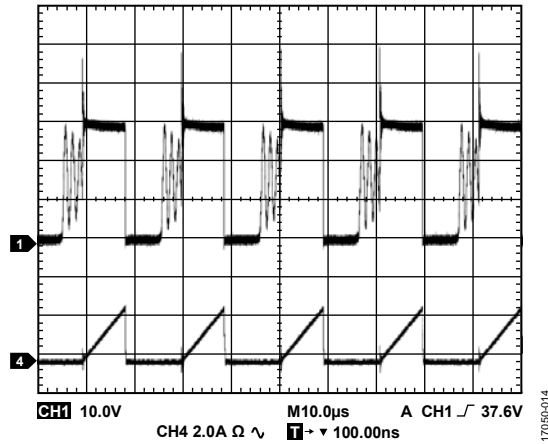

Figure 14. Peak Diode Voltage Stress on a -15 V Rail at 32 V_{DC} Input and Full Load

EFFICIENCY

Table 3 shows the typical efficiency measurement under different load conditions. Note that the minimal load of the 5.5 V rail and the 24 V rail are kept at 0.01 A to maintain adequate load regulation.

Table 3. Efficiency Measurement at Input Voltage (V_{IN}) = 24 V

OUT1 Voltage, V _{OUT1} (V)	OUT1 Current, I _{OUT1} (A)	OUT2 Voltage, V _{OUT2} (V)	OUT2 Current, I _{OUT2} (A)	OUT3 Voltage, V _{OUT3} (V)	OUT3 Current, I _{OUT3} (A)	Efficiency (%)
25.72	0.01	5.36	0.01	14.83	0.2	85.33
27.27	0.01	5.11	0.5	15.59	0.2	82.61
28.12	0.01	5.00	0.5	18.18	0	72.48
25.71	0.4	5.29	0.5	17.55	0	84.18
24.89	0.4	5.45	0.01	15.34	0.2	86.50
25.65	0.4	5.30	0.5	15.82	0.2	84.79

THERMAL PERFORMANCE

Figure 15 shows the typical thermal image of the evaluation board at different operating conditions.

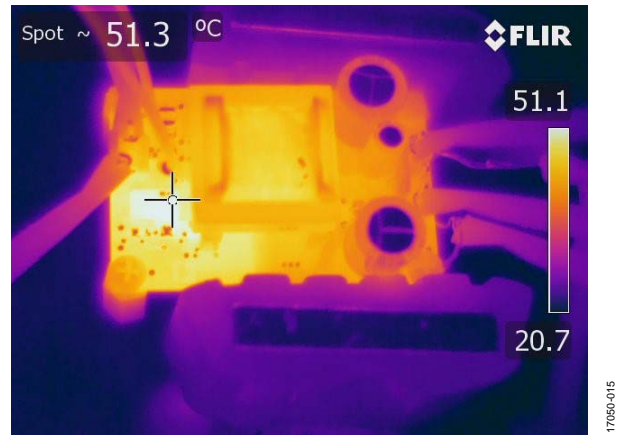

Figure 15. Thermal Image of the ADP1071-1 at 48 V_{DC} Input, Full Load, No Airflow, and 0.5 Hour Soaking Time

EVALUATION BOARD SCHEMATIC AND ARTWORK

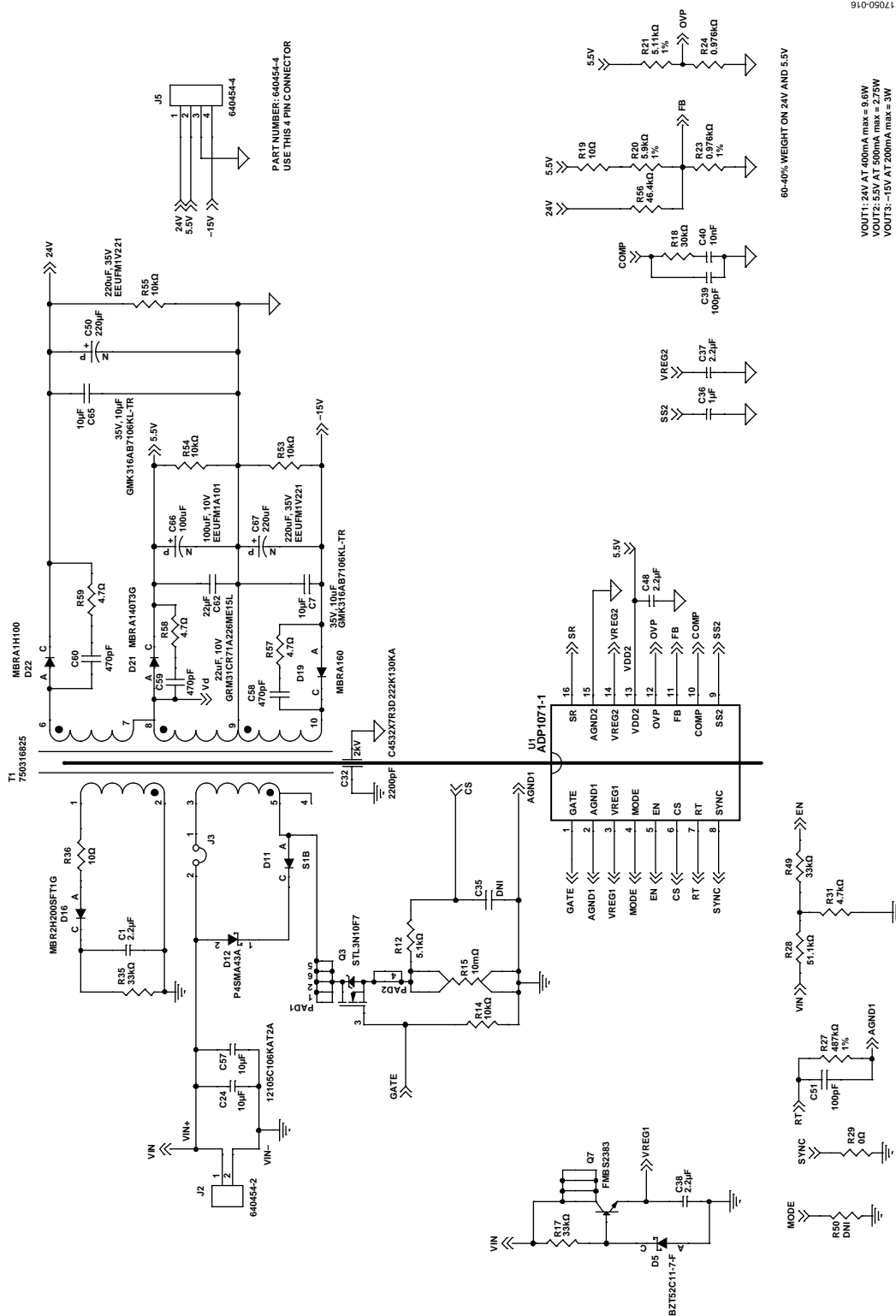

Figure 16. ADP1071-1EVALZ Evaluation Board Schematic

17050-016

VOUT1: 24V AT 400mA max = 9.6W
 VOUT2: 5.5V AT 500mA max = 2.75W
 VOUT3: -15V AT 200mA max = 3W

66-40% WEIGHT ON 24V AND 5.5V

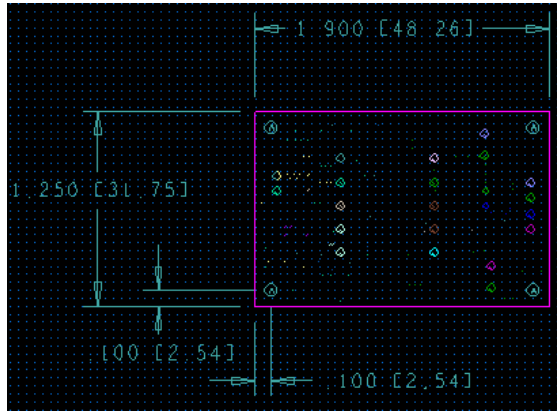

Figure 17. Board Outline

17086-017

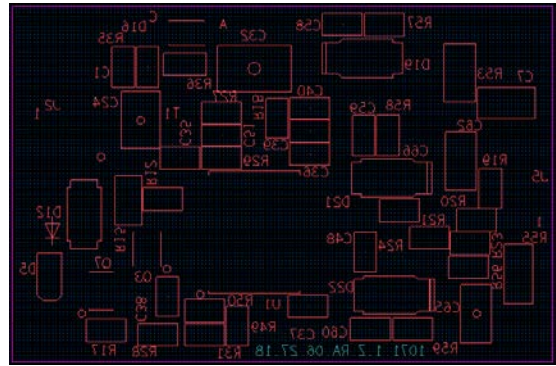

Figure 19. Silkscreen Bottom

17086-019

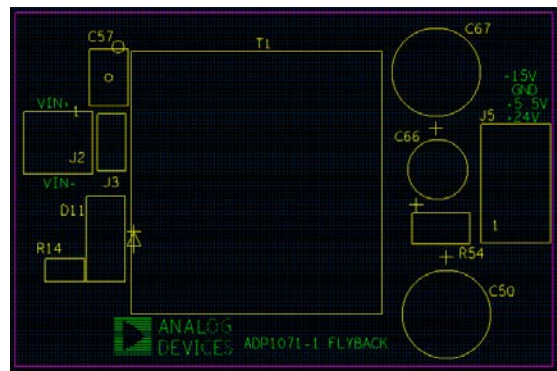

Figure 18. Silkscreen Top

17086-018

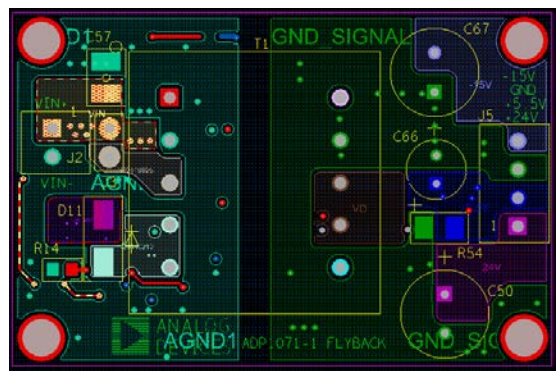
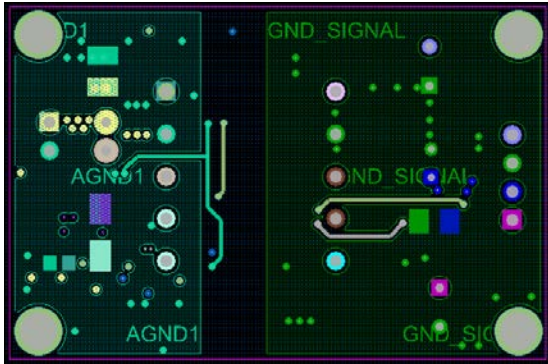

Figure 20. PCB Layout, Top Layer

17086-020



17050-021

Figure 21. PCB Layout, Layer 2

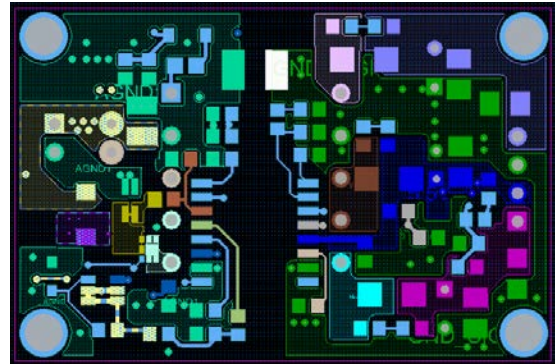

17050-023

Figure 23. PCB Layout, Layer 4

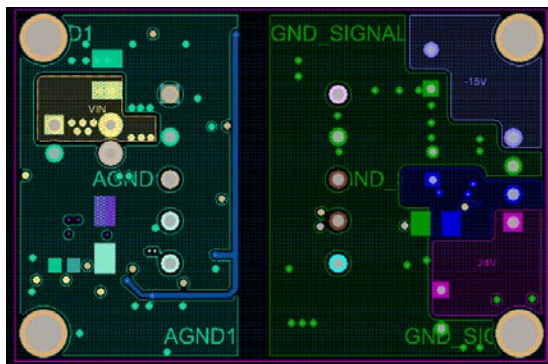

17050-022

Figure 22. PCB Layout, Layer 3

ORDERING INFORMATION

BILL OF MATERIALS

Table 4.

Quantity	Description	Reference Designator	Manufacturer ¹	Manufacturer Part Number ¹
1	2.2 μ F, 50 V, X5R, 0603, capacitor	C1	Murata	GRT188R61H225KE13D
1	SMD/SMT, 10 μ F, 35 V, X7R, \pm 10%, 1206, capacitors	C7	Taiyo Yuden	GMK316AB7106KL-TR
2	Ceramic capacitors, 10 μ F, 50 V, X7R, 1210	C24, C57	AVX Corp	12105C106KAT2A
1	SMD/SMT, X7R, 2 kV, 2200 pF, 10%, 1812, capacitor	C32	TDK	C4532X7R3D222K130KA
1	Ceramic capacitor, 100 pF, 50 V, 10%, X7R, SMD, 0603, do not install (DNI)	C35	AVX Corp	06035C102KAT2A
1	Ceramic capacitor, 1 μ F, 16 V, 10%, X5R, SMD, 0603	C36	Murata	GRM185R61C105KE44D
3	2.2 μ F, 50 V, X5R, 0603, capacitors	C37, C38, C48	Murata	GRT188R61H225KE13D
2	SMD/SMT, 50 V, 100 pF, 10%, capacitors, 0603	C39, C51	Kemet	C0603C101K5RACTU
1	Ceramic capacitor, 10 nF, 100 V, 10%, X7R, SMD, 0603	C40	AVX Corp	C0603C103K2RACTU
2	Capacitors, 220 μ F, 35 V, CPLRAD138D315H433LD24	C50, C67	Panasonic	EEUFM1V221
3	0603, 470 pF, 100 V, X7R, 10%, capacitors	C58, C59, C60	Murata	GRM188R72A471KA01D
1	Ceramic capacitor chip, 22 μ F, 10 V, 1206	C62	Murata	GRM31CR71A226ME15L
1	Ceramic capacitor chip, 10 μ F, C1206H71	C65	Taiyo Yuden	GMK316AB7106KL-TR
1	Capacitor, 100 μ F, 10 V, CPLRAD100D197H300LD20	C66	Panasonic	EEUFM1A101
1	Zener diode, 300 mW, \pm 5%, surface mount SOD-323-2	D5	On Semiconductor	SZMM3Z11VT1G-ND
1	Diode, ultrafast, 100 V, 1 A, S1B, DO214AC-3	D11	Fairchild	S1B
1	ESD suppressor/TVS diode, 400 W, 43 V, unidirect, DO214AC_C	D12	Vishay	P4SMA43A-E3/5A
2	Schottky diodes and rectifiers, REC SOD123, 2 A, 200 V	D16, D18	On Semiconductor	MBR2H200SFT1G
1	Schottky diode and rectifier, 1 A, 60 V, SMA	D19	On Semiconductor	MBRA160
1	Schottky diode and rectifier, 1 A, 40 V, SMA	D21	On Semiconductor	MBRA140T3G
1	Schottky diode and rectifier, 1 A, 100 V, SMA	D22	On Semiconductor	MBRA1H100
1	CONN-PCB single row SMD terminal strip, 640454-2, CNTHMHDR1x2l200W225h415_A	J2	TE Connectivity	640454-2
1	Wire short	J3		
1	CONN-PCB single row SMD terminal strip, 640454-4, CNTHMHDR1X4L400W225H415_A	J5	TE Connectivity	640454-4
1	MOSFET power, 100 V, 4 A, 70 m Ω , MLP6_2X2_PAD_9X1_PAD_2X_56	Q3	Fairchild Semiconductor	STL3N10F7
1	Transistor, NPN, 160 V, 0.8 A	Q7	Fairchild	FMBS2383
1	SMD resistor, 5.1 k Ω , 1/8 W, 1%, 0603	R12		
1	SMD resistor, 10 k Ω , 1/8 W, 1%, 0603	R14		
1	1206, 10 m Ω , 1%, current sense resistor, 1210-4_A	R15	Vishay Dale	ERJ-8BWF010V
1	SMD resistor, 33 k Ω , 1/8 W, 1%, 0603	R17		
1	SMD resistor, 30.1 k Ω , 1/8 W, 1%, 0603	R18		
1	SMD resistor, 10 Ω , 1/8 W, 1%, 0603	R19		
1	SMD resistor, 5.9 k Ω , 1/8 W, 1%, 0603	R20		
1	SMD resistor, 5.11 k Ω , 1/8 W, 1%, 0603	R21		
1	SMD resistor, 0.976 k Ω , 1/8 W, 1%, 0603	R23		
1	SMD resistor, 0.976 k Ω , 1/8 W, 1%, 0603	R24		
1	SMD resistor, 487 k Ω , 1/8 W, 1%, 0603	R27		
1	SMD resistor, 51.1 k Ω , 1/8 W, 1%, 0603	R28		
1	SMD resistor, 0 Ω , 1/8 W, jumper, 0603	R29		
1	SMD resistor, 4.75 k Ω , 1/8 W, 1%, 0603	R31		
1	SMD resistor, 33 k Ω , 1/8 W, 1%, 0603	R35		
1	SMD resistor, 10 Ω , 1/8 W, 1%, 0805	R36	AVX	08051C471KAZ2A
1	SMD resistor, 33 k Ω , 1/5 W, 0.1%, 0603	R49		
1	SMD resistor, 0 Ω , 1/8 W, jumper, DNI, 0603	R50		

Quantity	Description	Reference Designator	Manufacturer ¹	Manufacturer Part Number ¹
2	SMD resistors, 10 k Ω , 0.25 W, 5%, 1206	R53, R54	Panasonic	ERJ-8GEYJ103V
1	SMD resistor, 10 k Ω , 0.25 W, 5%, 1206	R55	Panasonic	ERJ-8GEYJ103V
1	SMD resistor, 46.4 k Ω , 1/8 W, 1%, 0603	R56		
4	SMD resistors, 4.7 Ω , 1/5 W, 0.1%, 0603	R57, R58, R59, R60		
1	Transformer	T1	Würth Electronics	750316825. Rev00
1	Flyback controller	U1	Analog Devices	ADP1071-1

¹ Blank rows in this column indicate that any manufacturer is possible.

NOTES

**ESD Caution**

ESD (electrostatic discharge) sensitive device. Charged devices and circuit boards can discharge without detection. Although this product features patented or proprietary protection circuitry, damage may occur on devices subjected to high energy ESD. Therefore, proper ESD precautions should be taken to avoid performance degradation or loss of functionality.

Legal Terms and Conditions

By using the evaluation board discussed herein (together with any tools, components documentation or support materials, the "Evaluation Board"), you are agreeing to be bound by the terms and conditions set forth below ("Agreement") unless you have purchased the Evaluation Board, in which case the Analog Devices Standard Terms and Conditions of Sale shall govern. Do not use the Evaluation Board until you have read and agreed to the Agreement. Your use of the Evaluation Board shall signify your acceptance of the Agreement. This Agreement is made by and between you ("Customer") and Analog Devices, Inc. ("ADI"), with its principal place of business at One Technology Way, Norwood, MA 02062, USA. Subject to the terms and conditions of the Agreement, ADI hereby grants to Customer a free, limited, personal, temporary, non-exclusive, non-sublicensable, non-transferable license to use the Evaluation Board FOR EVALUATION PURPOSES ONLY. Customer understands and agrees that the Evaluation Board is provided for the sole and exclusive purpose referenced above, and agrees not to use the Evaluation Board for any other purpose. Furthermore, the license granted is expressly made subject to the following additional limitations: Customer shall not (i) rent, lease, display, sell, transfer, assign, sublicense, or distribute the Evaluation Board; and (ii) permit any Third Party to access the Evaluation Board. As used herein, the term "Third Party" includes any entity other than ADI, Customer, their employees, affiliates and in-house consultants. The Evaluation Board is NOT sold to Customer; all rights not expressly granted herein, including ownership of the Evaluation Board, are reserved by ADI. CONFIDENTIALITY. This Agreement and the Evaluation Board shall all be considered the confidential and proprietary information of ADI. Customer may not disclose or transfer any portion of the Evaluation Board to any other party for any reason. Upon discontinuation of use of the Evaluation Board or termination of this Agreement, Customer agrees to promptly return the Evaluation Board to ADI. ADDITIONAL RESTRICTIONS. Customer may not disassemble, decompile or reverse engineer chips on the Evaluation Board. Customer shall inform ADI of any occurred damages or any modifications or alterations it makes to the Evaluation Board, including but not limited to soldering or any other activity that affects the material content of the Evaluation Board. Modifications to the Evaluation Board must comply with applicable law, including but not limited to the RoHS Directive. TERMINATION. ADI may terminate this Agreement at any time upon giving written notice to Customer. Customer agrees to return to ADI the Evaluation Board at that time. LIMITATION OF LIABILITY. THE EVALUATION BOARD PROVIDED HEREUNDER IS PROVIDED "AS IS" AND ADI MAKES NO WARRANTIES OR REPRESENTATIONS OF ANY KIND WITH RESPECT TO IT. ADI SPECIFICALLY DISCLAIMS ANY REPRESENTATIONS, ENDORSEMENTS, GUARANTEES, OR WARRANTIES, EXPRESS OR IMPLIED, RELATED TO THE EVALUATION BOARD INCLUDING, BUT NOT LIMITED TO, THE IMPLIED WARRANTY OF MERCHANTABILITY, TITLE, FITNESS FOR A PARTICULAR PURPOSE OR NON-INFRINGEMENT OF INTELLECTUAL PROPERTY RIGHTS. IN NO EVENT WILL ADI AND ITS LICENSORS BE LIABLE FOR ANY INCIDENTAL, SPECIAL, INDIRECT, OR CONSEQUENTIAL DAMAGES RESULTING FROM CUSTOMER'S POSSESSION OR USE OF THE EVALUATION BOARD, INCLUDING BUT NOT LIMITED TO LOST PROFITS, DELAY COSTS, LABOR COSTS OR LOSS OF GOODWILL. ADI'S TOTAL LIABILITY FROM ANY AND ALL CAUSES SHALL BE LIMITED TO THE AMOUNT OF ONE HUNDRED US DOLLARS (\$100.00). EXPORT. Customer agrees that it will not directly or indirectly export the Evaluation Board to another country, and that it will comply with all applicable United States federal laws and regulations relating to exports. GOVERNING LAW. This Agreement shall be governed by and construed in accordance with the substantive laws of the Commonwealth of Massachusetts (excluding conflict of law rules). Any legal action regarding this Agreement will be heard in the state or federal courts having jurisdiction in Suffolk County, Massachusetts, and Customer hereby submits to the personal jurisdiction and venue of such courts. The United Nations Convention on Contracts for the International Sale of Goods shall not apply to this Agreement and is expressly disclaimed.

©2018 Analog Devices, Inc. All rights reserved. Trademarks and registered trademarks are the property of their respective owners.
UG17050-0-8/18(0)



**ANALOG
DEVICES**

www.analog.com

X-ON Electronics

Largest Supplier of Electrical and Electronic Components

Click to view similar products for [Power Management IC Development Tools](#) category:

Click to view products by [Analog Devices](#) manufacturer:

Other Similar products are found below :

[EVAL-ADM1168LQEBZ](#) [EVB-EP5348UI](#) [MIC23451-AAAYFL EV](#) [MIC5281YMME EV](#) [DA9063-EVAL](#) [ADP122-3.3-EVALZ](#) [ADP130-0.8-EVALZ](#) [ADP130-1.2-EVALZ](#) [ADP130-1.5-EVALZ](#) [ADP130-1.8-EVALZ](#) [ADP1714-3.3-EVALZ](#) [ADP1716-2.5-EVALZ](#) [ADP1740-1.5-EVALZ](#) [ADP1752-1.5-EVALZ](#) [ADP1828LC-EVALZ](#) [ADP1870-0.3-EVALZ](#) [ADP1871-0.6-EVALZ](#) [ADP1873-0.6-EVALZ](#) [ADP1874-0.3-EVALZ](#) [ADP1882-1.0-EVALZ](#) [ADP199CB-EVALZ](#) [ADP2102-1.25-EVALZ](#) [ADP2102-1.875EVALZ](#) [ADP2102-1.8-EVALZ](#) [ADP2102-2-EVALZ](#) [ADP2102-3-EVALZ](#) [ADP2102-4-EVALZ](#) [ADP2106-1.8-EVALZ](#) [ADP2147CB-110EVALZ](#) [AS3606-DB](#) [BQ24010EVM](#) [BQ24075TEVM](#) [BQ24155EVM](#) [BQ24157EVM-697](#) [BQ24160EVM-742](#) [BQ24296MEVM-655](#) [BQ25010EVM](#) [BQ3055EVM](#) [NCV891330PD50GEVB](#) [ISLUSBI2CKIT1Z](#) [LM2744EVAL](#) [LM2854EVAL](#) [LM3658SD-AEV/NOPB](#) [LM3658SDEV/NOPB](#) [LM3691TL-1.8EV/NOPB](#) [LM4510SDEV/NOPB](#) [LM5033SD-EVAL](#) [LP38512TS-1.8EV](#) [EVAL-ADM1186-1MBZ](#) [EVAL-ADM1186-2MBZ](#)