

### FEATURES

- Wide input voltage range: 4 V to 28 V
- Maximum output current: 50 mA
- Low light load current:
  - 28  $\mu$ A at 0  $\mu$ A load
  - 35  $\mu$ A at 100  $\mu$ A load
- Low shutdown current: 0.7  $\mu$ A
- Low dropout voltage: 275 mV @ 50 mA load
- Initial accuracy:  $\pm 0.5\%$
- Accuracy over line, load, and temperature:  $\pm 2\%$
- Stable with small 1  $\mu$ F ceramic output capacitor
- Fixed 3.3 V and 5.0 V output voltage options
- Adjustable output voltage option: 1.225 V to 5.0 V
- Current limit and thermal overload protection
- Logic controlled enable
- Space-saving thermally enhanced MSOP package

### APPLICATIONS

- DC-to-DC post regulation
- PCMCIA regulation
- Keep-alive power in portable equipment
- Industrial applications

### GENERAL DESCRIPTION

The ADP1720 is a high voltage, micropower, low dropout linear regulator. Operating over a very wide input voltage range of 4 V to 28 V, the ADP1720 can provide up to 50 mA of output current. With just 28  $\mu$ A of quiescent supply current and a micropower shutdown mode, this device is ideal for applications that require low quiescent current.

The ADP1720 is available in fixed output voltages of 3.3 V and 5.0 V. An adjustable version is also available, which allows the output to be set anywhere between 1.225 V and 5.0 V. An enable function that allows external circuits to turn on and turn off the ADP1720 output is available. For automatic startup, the enable (EN) pin can be connected directly to the input rail.

### TYPICAL APPLICATION CIRCUITS

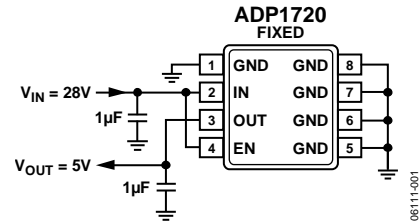

Figure 1. ADP1720 with Fixed Output Voltage, 5.0 V

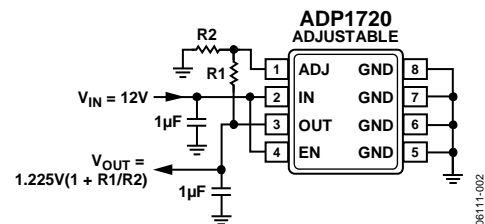

Figure 2. ADP1720 with Adjustable Output Voltage, 1.225 V to 5.0 V

The ADP1720 is optimized for stable operation with small 1  $\mu$ F ceramic output capacitors, allowing for good transient performance while occupying minimal board space.

The ADP1720 operates from  $-40^{\circ}\text{C}$  to  $+125^{\circ}\text{C}$  and uses current limit protection and thermal overload protection circuits to prevent damage to the device in adverse conditions.

Available in a small thermally enhanced MSOP package, the ADP1720 provides a compact solution with low thermal resistance.

#### Rev. A

Information furnished by Analog Devices is believed to be accurate and reliable. However, no responsibility is assumed by Analog Devices for its use, nor for any infringements of patents or other rights of third parties that may result from its use. Specifications subject to change without notice. No license is granted by implication or otherwise under any patent or patent rights of Analog Devices. Trademarks and registered trademarks are the property of their respective owners.

## TABLE OF CONTENTS

|  |   |  |    |
|--|---|--|----|
| Features .....                                     | 1 | Typical Performance Characteristics .....            | 7  |
| Applications.....                                  | 1 | Theory of Operation .....                            | 10 |
| Typical Application Circuits.....                  | 1 | Adjustable Output Voltage (ADP1720 Adjustable) ..... | 10 |
| General Description .....                          | 1 | Applications Information .....                       | 11 |
| Revision History .....                             | 2 | Capacitor Selection .....                            | 11 |
| Specifications.....                                | 3 | Current Limit and Thermal Overload Protection .....  | 11 |
| Absolute Maximum Ratings.....                      | 5 | Thermal Considerations.....                          | 12 |
| Thermal Resistance .....                           | 5 | Printed Circuit Board Layout Considerations .....    | 14 |
| ESD Caution.....                                   | 5 | Outline Dimensions .....                             | 15 |
| Pin Configurations and Function Descriptions ..... | 6 | Ordering Guide .....                                 | 15 |

## REVISION HISTORY

### 7/07—Rev. 0 to Rev. A

|                                 |    |
|---------------------------------|----|
| Change to Figure 1 .....        | 1  |
| Changes to Table 1.....         | 3  |
| Changes to Ordering Guide ..... | 15 |

### 2/07—Revision 0: Initial Version

## SPECIFICATIONS

$V_{IN} = 12\text{ V}$ ,  $I_{OUT} = 100\ \mu\text{A}$ ,  $C_{IN} = C_{OUT} = 1\ \mu\text{F}$ ,  $T_A = 25^\circ\text{C}$ , unless otherwise noted.

Table 1.

| Parameter                                       | Symbol                          | Conditions  | Min                        | Typ                      | Max                        | Unit  |
|---|---------------------------------|---|----------------------------|--------------------------|----------------------------|---|
| INPUT VOLTAGE RANGE                             | $V_{IN}$                        | $T_J = -40^\circ\text{C}$ to $+125^\circ\text{C}$   | 4                          |                          | 28                         | V   |
| OPERATING SUPPLY CURRENT                        | $I_{GND}$                       | $I_{OUT} = 0\ \mu\text{A}$<br>$I_{OUT} = 0\ \mu\text{A}$ , $V_{IN} = V_{OUT} + 0.5\text{ V}$ or $4\text{ V}$ (whichever is greater), $T_J = -40^\circ\text{C}$ to $+125^\circ\text{C}$<br>$I_{OUT} = 100\ \mu\text{A}$<br>$I_{OUT} = 100\ \mu\text{A}$ , $V_{IN} = V_{OUT} + 0.5\text{ V}$ or $4\text{ V}$ (whichever is greater), $T_J = -40^\circ\text{C}$ to $+125^\circ\text{C}$<br>$I_{OUT} = 1\text{ mA}$<br>$I_{OUT} = 1\text{ mA}$ , $V_{IN} = V_{OUT} + 0.5\text{ V}$ or $4\text{ V}$ (whichever is greater), $T_J = -40^\circ\text{C}$ to $+125^\circ\text{C}$<br>$I_{OUT} = 10\text{ mA}$<br>$I_{OUT} = 10\text{ mA}$ , $V_{IN} = V_{OUT} + 0.5\text{ V}$ or $4\text{ V}$ (whichever is greater), $T_J = -40^\circ\text{C}$ to $+125^\circ\text{C}$<br>$100\ \mu\text{A} < I_{OUT} < 50\text{ mA}$ , $V_{IN} = V_{OUT} + 0.5\text{ V}$ or $4\text{ V}$ (whichever is greater), $T_J = -40^\circ\text{C}$ to $+125^\circ\text{C}$ |                            | 28                       | 80                         | $\mu\text{A}$<br>$\mu\text{A}$<br>$\mu\text{A}$<br>$\mu\text{A}$<br>$\mu\text{A}$<br>$\mu\text{A}$<br>$\mu\text{A}$ |
| SHUTDOWN CURRENT                                | $I_{GND-SD}$                    | $EN = GND$<br>$EN = GND$ , $T_J = -40^\circ\text{C}$ to $+125^\circ\text{C}$  |                            | 0.7                      | 1.5                        | $\mu\text{A}$<br>$\mu\text{A}$  |
| OUTPUT  |                                 |   |                            |                          |                            |   |
| Fixed Output Voltage Accuracy                   | $V_{OUT}$                       | $I_{OUT} = 100\ \mu\text{A}$<br>$100\ \mu\text{A} < I_{OUT} < 50\text{ mA}$<br>$100\ \mu\text{A} < I_{OUT} < 50\text{ mA}$ , $T_J = -40^\circ\text{C}$ to $+125^\circ\text{C}$  | -0.5<br>-1<br>-2           |                          | +0.5<br>+1<br>+2           | %<br>%<br>%   |
| Adjustable Output <sup>1</sup> Voltage Accuracy | $V_{OUT}$                       | $I_{OUT} = 100\ \mu\text{A}$<br>$100\ \mu\text{A} < I_{OUT} < 50\text{ mA}$<br>$100\ \mu\text{A} < I_{OUT} < 50\text{ mA}$ , $T_J = -40^\circ\text{C}$ to $+125^\circ\text{C}$  | 1.2188<br>1.2127<br>1.2005 | 1.2250                   | 1.2311<br>1.2372<br>1.2495 | V<br>V<br>V   |
| Noise (10 Hz to 100 kHz)                        | $OUT_{NOISE}$                   | $V_{OUT} = 1.6\text{ V}$ , $C_{OUT} = 1\ \mu\text{F}$<br>$V_{OUT} = 1.6\text{ V}$ , $C_{OUT} = 10\ \mu\text{F}$<br>$V_{OUT} = 5\text{ V}$ , $C_{OUT} = 1\ \mu\text{F}$<br>$V_{OUT} = 5\text{ V}$ , $C_{OUT} = 10\ \mu\text{F}$  |                            | 146<br>124<br>340<br>266 |                            | $\mu\text{V rms}$<br>$\mu\text{V rms}$<br>$\mu\text{V rms}$<br>$\mu\text{V rms}$                                    |
| REGULATION                                      |                                 |   |                            |                          |                            |   |
| Line Regulation                                 | $\Delta V_{OUT}/\Delta V_{IN}$  | $V_{IN} = (V_{OUT} + 0.5\text{ V})$ to $28\text{ V}$ , $T_J = -40^\circ\text{C}$ to $+125^\circ\text{C}$  | -0.02                      |                          | +0.02                      | %/V   |
| Load Regulation <sup>2</sup>                    | $\Delta V_{OUT}/\Delta I_{OUT}$ | $1\text{ mA} < I_{OUT} < 50\text{ mA}$<br>$1\text{ mA} < I_{OUT} < 50\text{ mA}$ , $T_J = -40^\circ\text{C}$ to $+125^\circ\text{C}$  |                            | 0.001                    |                            | %/mA<br>%/mA  |
| DROPOUT VOLTAGE <sup>3</sup>                    | $V_{DROPOUT}$                   | $I_{OUT} = 10\text{ mA}$<br>$I_{OUT} = 10\text{ mA}$ , $T_J = -40^\circ\text{C}$ to $+125^\circ\text{C}$<br>$I_{OUT} = 50\text{ mA}$<br>$I_{OUT} = 50\text{ mA}$ , $T_J = -40^\circ\text{C}$ to $+125^\circ\text{C}$  |                            | 55<br>275                | 105<br>480                 | mV<br>mV<br>mV<br>mV  |
| START-UP TIME <sup>4</sup>                      | $T_{START-UP}$                  |   |                            | 200                      |                            | $\mu\text{s}$   |
| CURRENT LIMIT THRESHOLD <sup>5</sup>            | $I_{LIMIT}$                     |   | 55                         | 90                       | 140                        | mA  |
| THERMAL CHARACTERISTICS                         |                                 |   |                            |                          |                            |   |
| Thermal Shutdown Threshold                      | $T_{SD}$                        | $T_J$ rising  |                            | 150                      |                            | $^\circ\text{C}$  |
| Thermal Shutdown Hysteresis                     | $T_{SD-HYS}$                    |   |                            | 15                       |                            | $^\circ\text{C}$  |
| EN CHARACTERISTICS                              |                                 |   |                            |                          |                            |   |
| EN Input Logic High                             | $V_{IH}$                        | $4\text{ V} \leq V_{IN} \leq 28\text{ V}$   | 1.8                        |                          |                            | V   |
| EN Input Logic Low                              | $V_{IL}$                        | $4\text{ V} \leq V_{IN} \leq 28\text{ V}$   |                            |                          | 0.4                        | V   |
| EN Input Leakage Current                        | $V_{I-LEAKAGE}$                 | $EN = GND$<br>$EN = IN$   |                            | 0.1<br>0.5               | 1<br>1                     | $\mu\text{A}$<br>$\mu\text{A}$  |
| ADJ INPUT BIAS CURRENT (ADP1720 ADJUSTABLE)     | $ADJ_{I-BIAS}$                  |   |                            | 30                       | 100                        | nA  |

# ADP1720

| Parameter                    | Symbol | Conditions  | Min | Typ | Max | Unit |
|------------------------------|--------|---|-----|-----|-----|------|
| POWER SUPPLY REJECTION RATIO | PSRR   | $f = 120 \text{ Hz}, V_{\text{IN}} = 8 \text{ V}, V_{\text{OUT}} = 1.6 \text{ V}$ |     | -90 |     | dB   |
|                              |        | $f = 1 \text{ kHz}, V_{\text{IN}} = 8 \text{ V}, V_{\text{OUT}} = 1.6 \text{ V}$  |     | -80 |     | dB   |
|                              |        | $f = 10 \text{ kHz}, V_{\text{IN}} = 8 \text{ V}, V_{\text{OUT}} = 1.6 \text{ V}$ |     | -60 |     | dB   |
|                              |        | $f = 120 \text{ Hz}, V_{\text{IN}} = 8 \text{ V}, V_{\text{OUT}} = 5 \text{ V}$   |     | -83 |     | dB   |
|                              |        | $f = 1 \text{ kHz}, V_{\text{IN}} = 8 \text{ V}, V_{\text{OUT}} = 5 \text{ V}$    |     | -70 |     | dB   |
|                              |        | $f = 10 \text{ kHz}, V_{\text{IN}} = 8 \text{ V}, V_{\text{OUT}} = 5 \text{ V}$   |     | -50 |     | dB   |

<sup>1</sup> Accuracy when OUT is connected directly to ADJ. When OUT voltage is set by external feedback resistors, absolute accuracy in adjust mode depends on the tolerances of resistors used.

<sup>2</sup> Based on an end-point calculation using 1 mA and 50 mA loads. See Figure 6 for typical load regulation performance for loads less than 1 mA.

<sup>3</sup> Dropout voltage is defined as the input to output voltage differential when the input voltage is set to the nominal output voltage. This applies only for output voltages above 4 V.

<sup>4</sup> Start-up time is defined as the time between the rising edge of EN to OUT being at 95% of its nominal value.

<sup>5</sup> Current limit threshold is defined as the current at which the output voltage drops to 90% of the specified typical value. For example, the current limit for a 5.0 V output voltage is defined as the current that causes the output voltage to drop to 90% of 5.0 V, or 4.5 V.

## ABSOLUTE MAXIMUM RATINGS

Table 2.

| Parameter                               | Rating                                      |
|---|---|
| IN to GND                               | -0.3 V to +30 V                             |
| OUT to GND                              | -0.3 V to IN or +6 V<br>(whichever is less) |
| EN to GND                               | -0.3 V to +30 V                             |
| ADJ to GND                              | -0.3 V to +6 V                              |
| Storage Temperature Range               | -65°C to +150°C                             |
| Operating Junction<br>Temperature Range | -40°C to +125°C                             |
| Soldering Conditions                    | JEDEC J-STD-020                             |

Stresses above those listed under Absolute Maximum Ratings may cause permanent damage to the device. This is a stress rating only; functional operation of the device at these or any other conditions above those indicated in the operational section of this specification is not implied. Exposure to absolute maximum rating conditions for extended periods may affect device reliability.

## THERMAL RESISTANCE

$\theta_{JA}$  is specified for the worst-case conditions, that is, a device soldered in a circuit board for surface-mount packages.

Table 3. Thermal Resistance

| Package Type | $\theta_{JA}$ | $\theta_{JC}$ | Unit |
|--------------|---------------|---------------|------|
| 8-Lead MSOP  | 118           | 57            | °C/W |

## ESD CAUTION



**ESD (electrostatic discharge) sensitive device.** Charged devices and circuit boards can discharge without detection. Although this product features patented or proprietary protection circuitry, damage may occur on devices subjected to high energy ESD. Therefore, proper ESD precautions should be taken to avoid performance degradation or loss of functionality.

# ADP1720

## PIN CONFIGURATIONS AND FUNCTION DESCRIPTIONS



Figure 3. 8-Lead MSOP

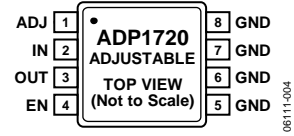

Figure 4. 8-Lead MSOP

Table 4. Pin Function Descriptions

| ADP1720 Fixed Pin No. | ADP1720 Adjustable Pin No. | Mnemonic | Description  |
|-----------------------|----------------------------|----------|--|
| 1                     | N/A                        | GND      | This pin is internally connected to ground.  |
| N/A                   | 1                          | ADJ      | Adjust. A resistor divider from OUT to ADJ sets the output voltage.  |
| 2                     | 2                          | IN       | Regulator Input Supply. Bypass IN to GND with a 1 $\mu$ F or greater capacitor.  |
| 3                     | 3                          | OUT      | Regulated Output Voltage. Bypass OUT to GND with a 1 $\mu$ F or greater capacitor.   |
| 4                     | 4                          | EN       | Enable Input. Drive EN high to turn on the regulator; drive it low to turn off the regulator. For automatic startup, connect EN to IN. |
| 5                     | 5                          | GND      | Ground.  |
| 6                     | 6                          | GND      | Ground.  |
| 7                     | 7                          | GND      | Ground.  |
| 8                     | 8                          | GND      | Ground.  |

# TYPICAL PERFORMANCE CHARACTERISTICS

$V_{IN} = 12\text{ V}$ ,  $V_{OUT} = 5\text{ V}$ ,  $I_{OUT} = 100\text{ }\mu\text{A}$ ,  $C_{IN} = C_{OUT} = 1\text{ }\mu\text{F}$ ,  $T_A = 25^\circ\text{C}$ , unless otherwise noted.

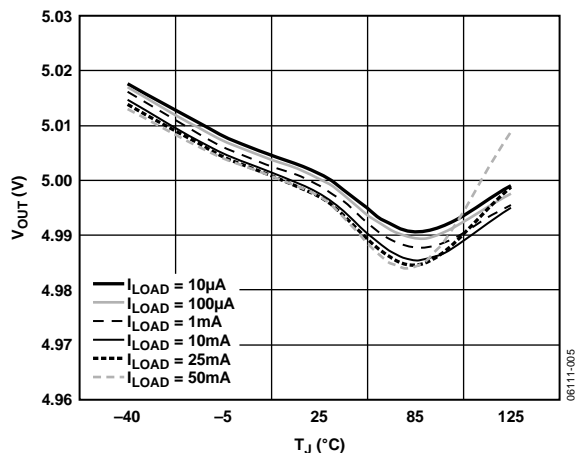

Figure 5. Output Voltage vs. Junction Temperature

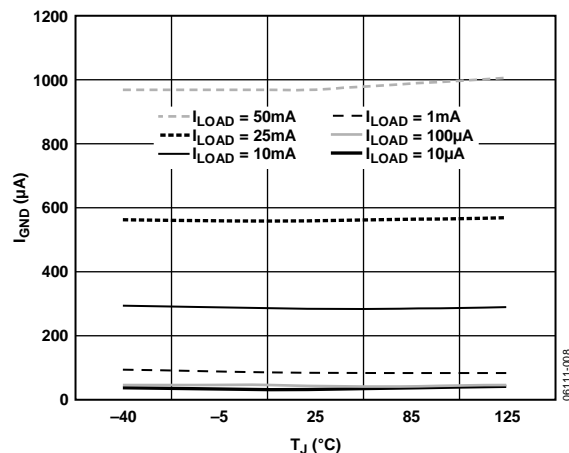

Figure 8. Ground Current vs. Junction Temperature

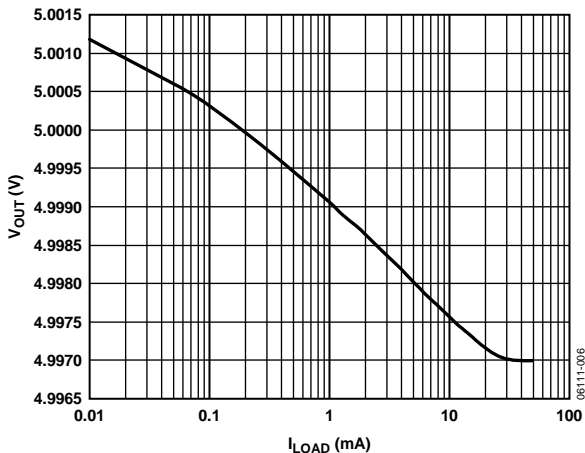

Figure 6. Output Voltage vs. Load Current

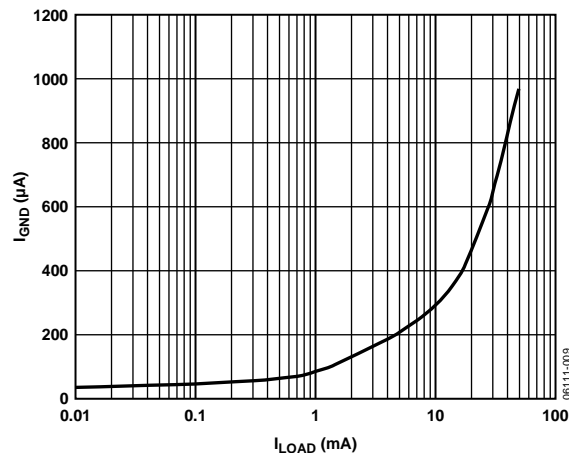

Figure 9. Ground Current vs. Load Current

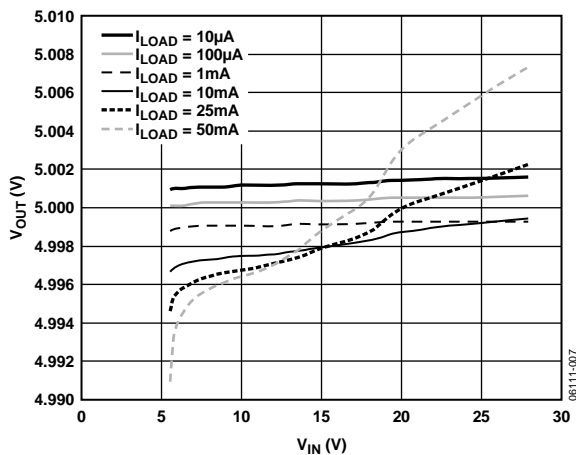

Figure 7. Output Voltage vs. Input Voltage

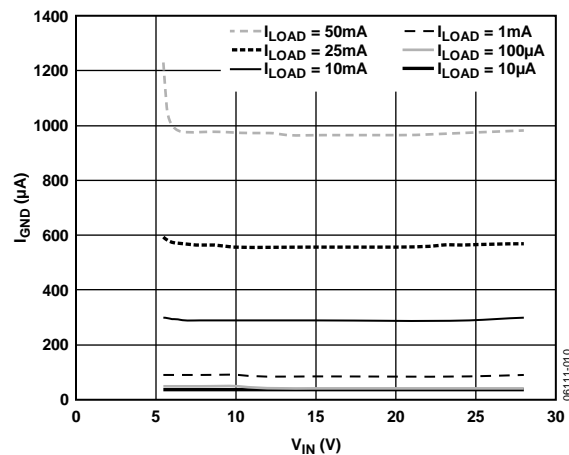

Figure 10. Ground Current vs. Input Voltage

# ADP1720

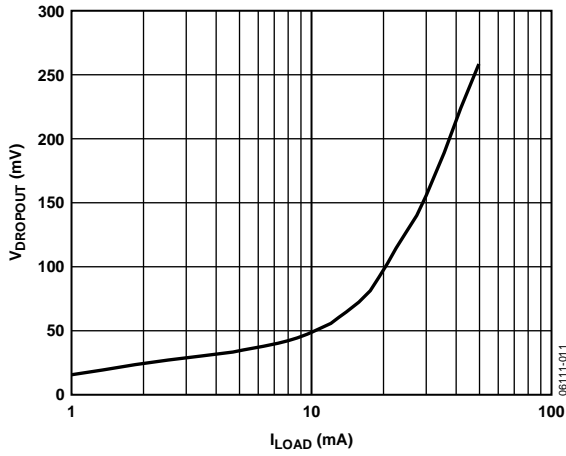

Figure 11. Dropout Voltage vs. Load Current

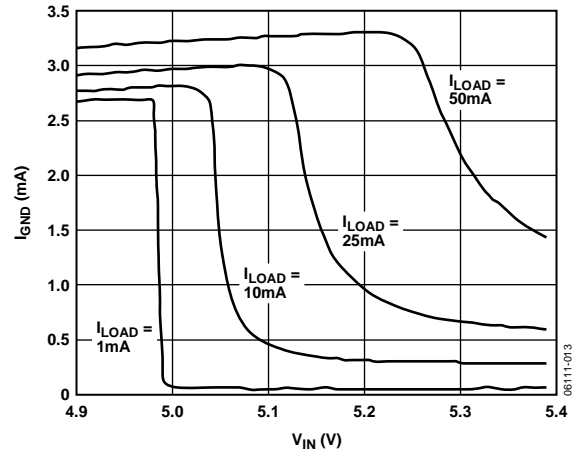

Figure 13. Ground Current vs. Input Voltage (in Dropout)

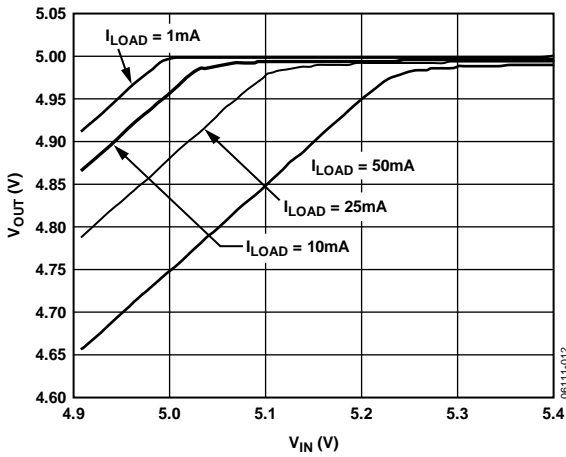

Figure 12. Output Voltage vs. Input Voltage (in Dropout)

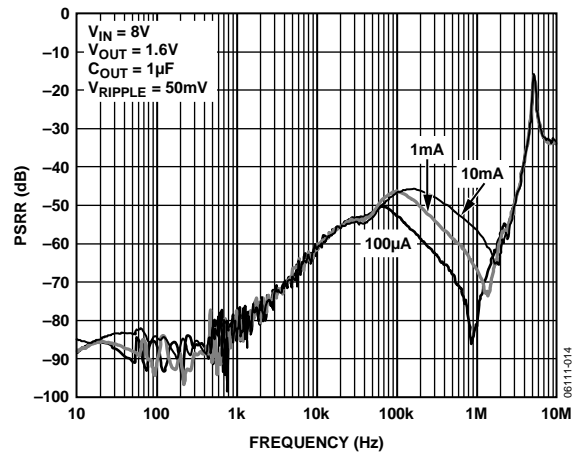

Figure 14. Power Supply Rejection Ratio vs. Frequency (1.6 V Adjustable Output)



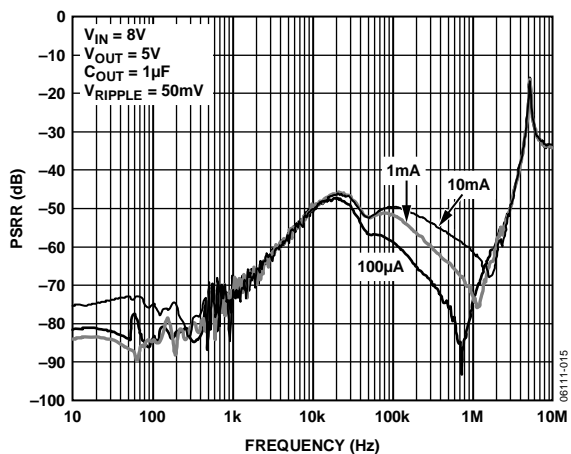

Figure 15. Power Supply Rejection Ratio vs. Frequency (5.0 V Fixed Output)

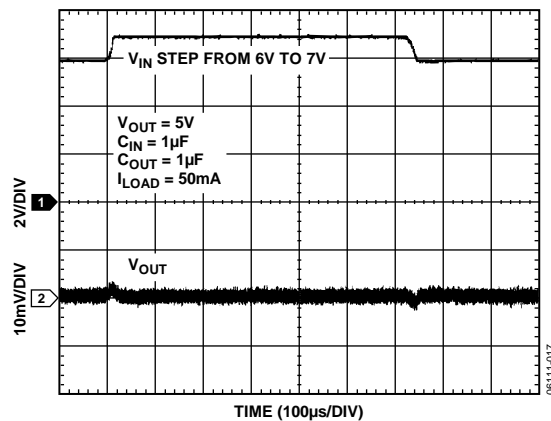

Figure 17. Line Transient Response

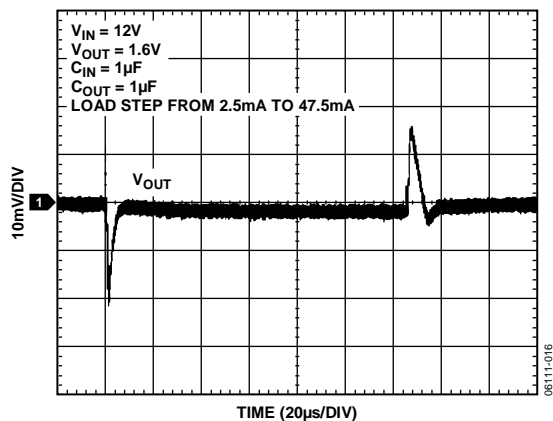

Figure 16. Load Transient Response

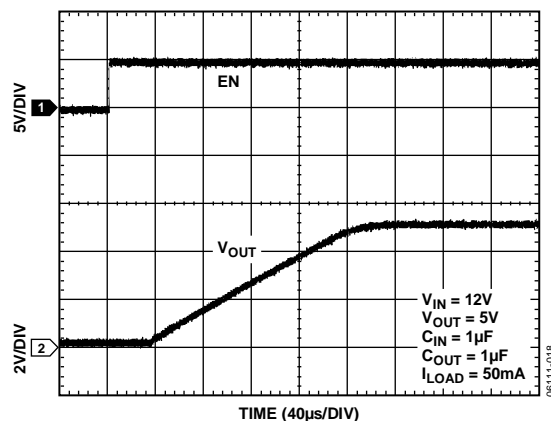

Figure 18. Start-Up Time

## THEORY OF OPERATION

The ADP1720 is a low dropout, BiCDMOS linear regulator that operates from a 4 V to 28 V input rail and provides up to 50 mA of output current. Ground current in shutdown mode is typically 700 nA. The ADP1720 is stable and provides high power supply rejection ratio (PSRR) and excellent line and load transient response with just a small 1  $\mu$ F ceramic output capacitor.

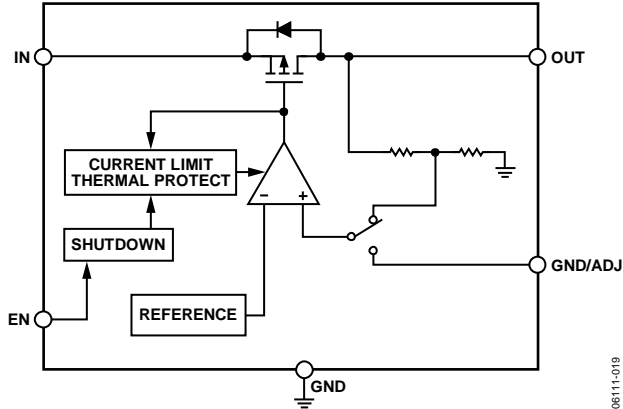

Figure 19. Internal Block Diagram

Internally, the ADP1720 consists of a reference, an error amplifier, a feedback voltage divider, and a DMOS pass transistor. Output current is delivered via the DMOS pass device, which is controlled by the error amplifier. The error amplifier compares the reference voltage with the feedback voltage from the output and amplifies the difference. If the feedback voltage is lower than the reference voltage, the gate of the DMOS device is pulled lower, allowing more current to pass and increasing the output voltage. If the feedback voltage is higher than the reference voltage, the gate of the PNP device is pulled higher, allowing less current to pass and decreasing the output voltage.

The ADP1720 is available in two versions, one with fixed output voltage options (see Figure 1) and one with an adjustable output voltage (see Figure 2). The fixed output voltage options are set internally to either 5.0 V or 3.3 V, using an internal feedback network. The adjustable output voltage can be set to between 1.225 V and 5.0 V by an external voltage divider connected from OUT to ADJ. The ADP1720 uses the EN pin to enable and disable the OUT pin under normal operating conditions. When EN is high, OUT turns on; when EN is low, OUT turns off. For automatic startup, EN can be tied to IN.

## ADJUSTABLE OUTPUT VOLTAGE (ADP1720 ADJUSTABLE)

The ADP1720 adjustable version can have its output voltage set over a 1.225 V to 5.0 V range. The output voltage is set by connecting a resistive voltage divider from OUT to ADJ. The output voltage is calculated using the equation

$$V_{OUT} = 1.225 \text{ V} (1 + R1/R2) \quad (1)$$

where:

$R1$  is the resistor from OUT to ADJ.

$R2$  is the resistor from ADJ to GND.

To make calculation of  $R1$  and  $R2$  easier, Equation 1 can be rearranged as follows:

$$R1 = R2 [(V_{OUT}/1.225) - 1] \quad (2)$$

The maximum bias current into ADJ is 100 nA; therefore, when less than 0.5% error is due to the bias current, use values less than 60 k $\Omega$  for  $R2$ .

## APPLICATIONS INFORMATION

### CAPACITOR SELECTION

#### Output Capacitor

The ADP1720 is designed for operation with small, space-saving ceramic capacitors, but it functions with most commonly used capacitors as long as care is taken about the effective series resistance (ESR) value. The ESR of the output capacitor affects stability of the LDO control loop. A minimum of  $1\ \mu\text{F}$  capacitance with an ESR of  $500\ \text{m}\Omega$  or less is recommended to ensure stability of the ADP1720. Transient response to changes in load current is also affected by output capacitance. Using a larger value of output capacitance improves the transient response of the ADP1720 to large changes in load current. Figure 20 and Figure 21 show the transient responses for output capacitance values of  $1\ \mu\text{F}$  and  $10\ \mu\text{F}$ , respectively.

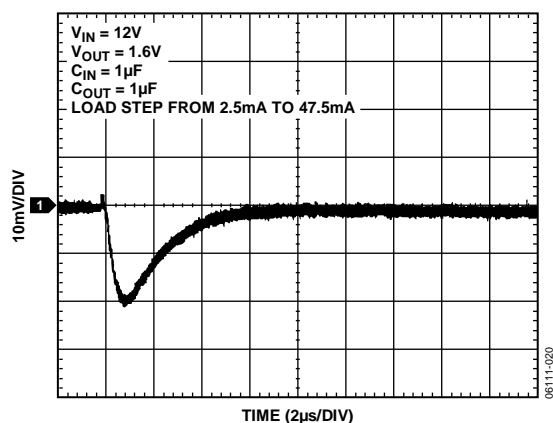

Figure 20. Output Transient Response,  $1\ \mu\text{F}$

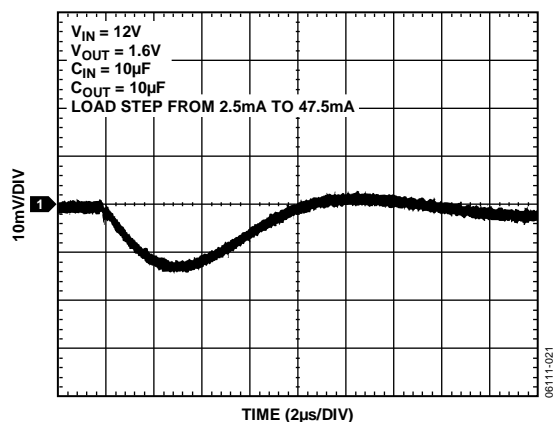

Figure 21. Output Transient Response,  $10\ \mu\text{F}$

#### Input Bypass Capacitor

Connecting a  $1\ \mu\text{F}$  capacitor from IN to GND reduces the circuit sensitivity to printed circuit board (PCB) layout, especially when encountering long input traces or high source impedance. If greater than  $1\ \mu\text{F}$  of output capacitance is required, it is recommended that the input capacitor be increased to match it.

#### Input and Output Capacitor Properties

Any good quality ceramic capacitors can be used with the ADP1720, as long as they meet the minimum capacitance and maximum ESR requirements. Ceramic capacitors are manufactured with a variety of dielectrics, each with different behavior over temperature and applied voltage. Capacitors must have a dielectric adequate to ensure the minimum capacitance over the necessary temperature range and dc bias conditions. X5R or X7R dielectrics with a voltage rating of  $6.3\ \text{V}$  or  $10\ \text{V}$  are recommended for the output capacitor. X5R or X7R dielectrics with a voltage rating of  $50\ \text{V}$  or higher are recommended for the input capacitor.

Y5V and Z5U dielectrics are not recommended, due to their poor temperature and dc bias characteristics.

### CURRENT LIMIT AND THERMAL OVERLOAD PROTECTION

Current limit and thermal overload protection circuits on the ADP1720 protect the part from damage caused by excessive power dissipation. The ADP1720 is designed to current limit when the output load reaches  $90\ \text{mA}$  (typical). When the output load exceeds  $90\ \text{mA}$ , the output voltage is reduced to maintain a constant current limit.

Thermal overload protection is included, which limits the junction temperature to a maximum of  $150^\circ\text{C}$  (typical). Under extreme conditions (that is, high ambient temperature and power dissipation), when the junction temperature starts to rise above  $150^\circ\text{C}$ , the output is turned off, reducing the output current to zero. When the junction temperature drops below  $135^\circ\text{C}$ , the output is turned on again, and output current is restored to its nominal value.

Consider the case where a hard short from OUT to GND occurs. At first, the ADP1720 current limits so that only  $90\ \text{mA}$  is conducted into the short. If self-heating of the junction is great enough to cause its temperature to rise above  $150^\circ\text{C}$ , thermal shutdown activates, turning off the output and reducing the output current to zero. As the junction temperature cools and drops below  $135^\circ\text{C}$ , the output turns on and conducts  $90\ \text{mA}$  into the short, again causing the junction temperature to rise above  $150^\circ\text{C}$ . This thermal oscillation between  $135^\circ\text{C}$  and  $150^\circ\text{C}$  causes a current oscillation between  $90\ \text{mA}$  and  $0\ \text{mA}$ , which continues as long as the short remains at the output.

Current and thermal limit protections are intended to protect the device against accidental overload conditions. For reliable operation, device power dissipation must be externally limited so that junction temperatures do not exceed  $125^\circ\text{C}$ .

## THERMAL CONSIDERATIONS

To guarantee reliable operation, the junction temperature of the ADP1720 must not exceed 125°C. To ensure the junction temperature stays below this maximum value, the user needs to be aware of the parameters that contribute to junction temperature changes. These parameters include ambient temperature, power dissipation in the power device, and thermal resistances between the junction and ambient air ( $\theta_{JA}$ ). The  $\theta_{JA}$  number is dependent on the package assembly compounds used and the amount of copper to which the GND pins of the package are soldered on the PCB. Table 5 shows typical  $\theta_{JA}$  values of the 8-lead MSOP package for various PCB copper sizes.

**Table 5.**

| Copper Size (mm <sup>2</sup> ) | $\theta_{JA}$ (°C/W) |
|--------------------------------|----------------------|
| 0 <sup>1</sup>                 | 118                  |
| 50                             | 99                   |
| 100                            | 77                   |
| 300                            | 75                   |
| 500                            | 74                   |

<sup>1</sup> Device soldered to minimum size pin traces.

The junction temperature of the ADP1720 can be calculated from the following equation:

$$T_J = T_A + (P_D \times \theta_{JA}) \quad (3)$$

where:

$T_A$  is the ambient temperature.

$P_D$  is the power dissipation in the die, given by

$$P_D = [(V_{IN} - V_{OUT}) \times I_{LOAD}] + (V_{IN} \times I_{GND}) \quad (4)$$

where:

$I_{LOAD}$  is the load current.

$I_{GND}$  is the ground current.

$V_{IN}$  and  $V_{OUT}$  are input and output voltages, respectively.

Power dissipation due to ground current is quite small and can be ignored. Therefore, the junction temperature equation simplifies to the following:

$$T_J = T_A + \{[(V_{IN} - V_{OUT}) \times I_{LOAD}] \times \theta_{JA}\} \quad (5)$$

As shown in Equation 5, for a given ambient temperature, input-to-output voltage differential, and continuous load current, there exists a minimum copper size requirement for the PCB to ensure that the junction temperature does not rise above 125°C. Figure 22 to Figure 27 show junction temperature calculations for different ambient temperatures, load currents,  $V_{IN}$  to  $V_{OUT}$  differentials, and areas of PCB copper.

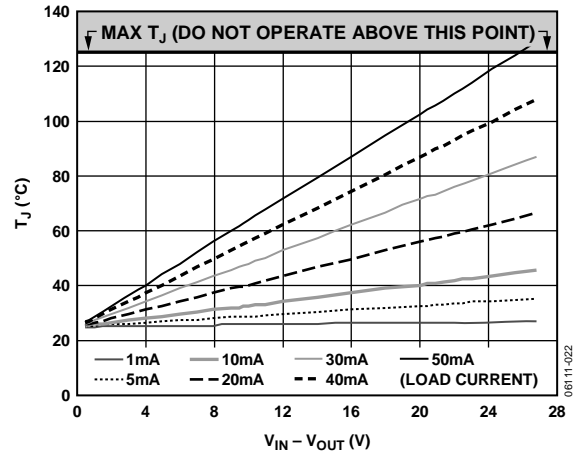

Figure 22. 300 mm<sup>2</sup> of PCB Copper,  $T_A = 25^\circ\text{C}$

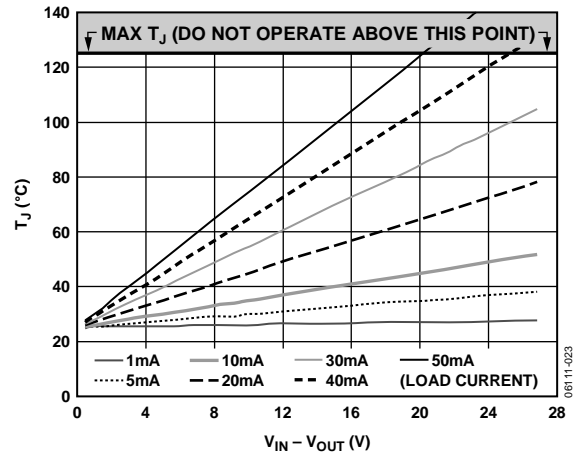

Figure 23. 100 mm<sup>2</sup> of PCB Copper,  $T_A = 25^\circ\text{C}$

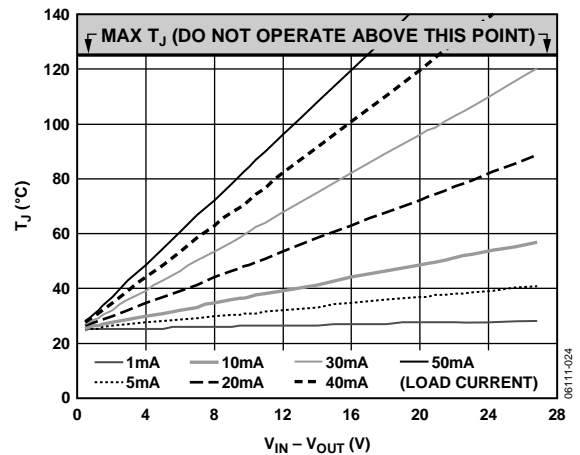

Figure 24. 0 mm<sup>2</sup> of PCB Copper,  $T_A = 25^\circ\text{C}$

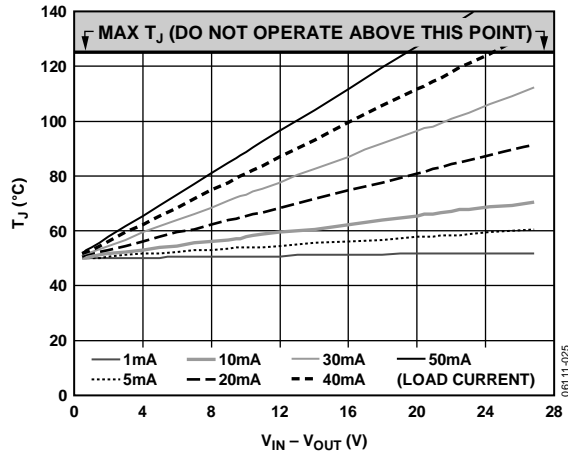

Figure 25. 300 mm<sup>2</sup> of PCB Copper,  $T_A = 50^\circ\text{C}$

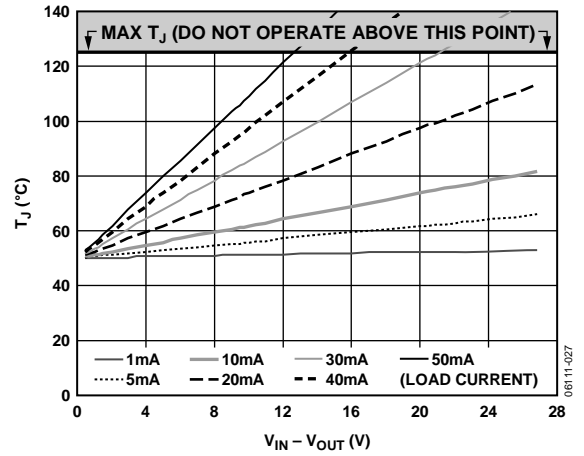

Figure 27. 0 mm<sup>2</sup> of PCB Copper,  $T_A = 50^\circ\text{C}$

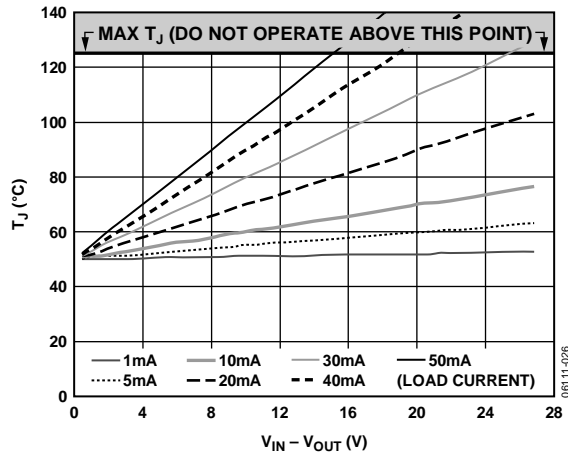

Figure 26. 100 mm<sup>2</sup> of PCB Copper,  $T_A = 50^\circ\text{C}$

# ADP1720

## PRINTED CIRCUIT BOARD LAYOUT CONSIDERATIONS

Heat dissipation from the package can be improved by increasing the amount of copper attached to the pins of the ADP1720. However, as can be seen from Table 5, a point of diminishing returns eventually is reached, beyond which an increase in the copper size does not yield significant heat dissipation benefits.

Place the input capacitor as close as possible to the IN and GND pins. Place the output capacitor as close as possible to the OUT and GND pins. Use of 0402 or 0603 size capacitors and resistors achieves the smallest possible footprint solution on boards where area is limited.

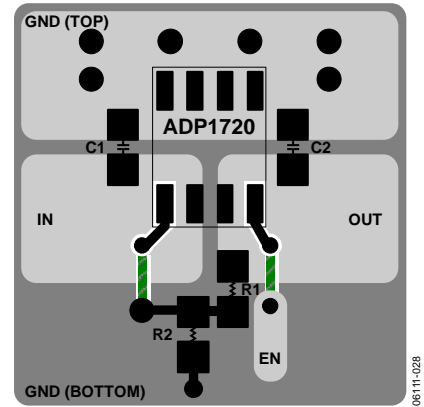
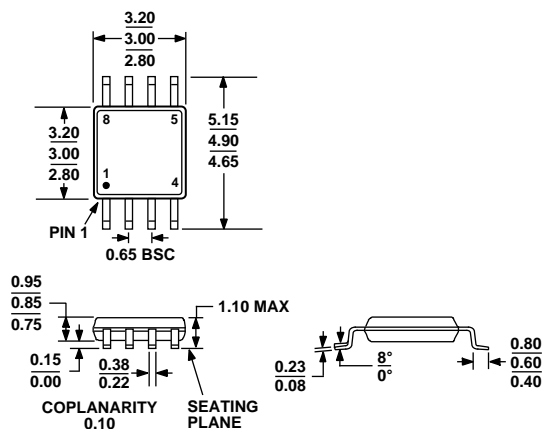

Figure 28. Example PCB Layout

## OUTLINE DIMENSIONS



COMPLIANT TO JEDEC STANDARDS MO-187-AA

Figure 29. 8-Lead Mini Small Outline Package [MSOP]  
(RM-8)

Dimensions shown in millimeters

## ORDERING GUIDE

| Model                           | Temperature Range | Output Voltage (V) | Package Description | Package Option | Branding |
|---------------------------------|-------------------|--------------------|---------------------|----------------|----------|
| ADP1720ARMZ-5-R7 <sup>1</sup>   | -40°C to +125°C   | 5                  | 8-Lead MSOP         | RM-8           | L30      |
| ADP1720ARMZ-3.3-R7 <sup>1</sup> | -40°C to +125°C   | 3.3                | 8-Lead MSOP         | RM-8           | L2Z      |
| ADP1720ARMZ-R7 <sup>1</sup>     | -40°C to +125°C   | 1.225 to 5         | 8-Lead MSOP         | RM-8           | L2M      |
| ADP1720-5-EVALZ <sup>1</sup>    |                   | 5                  | Evaluation Board    |                |          |
| ADP1720-3.3-EVALZ <sup>1</sup>  |                   | 3.3                | Evaluation Board    |                |          |
| ADP1720-EVALZ <sup>1</sup>      |                   | 1.225 to 5         | Evaluation Board    |                |          |

<sup>1</sup> Z = RoHS Compliant Part.

**ADP1720**

**NOTES**



## X-ON Electronics

Largest Supplier of Electrical and Electronic Components

*Click to view similar products for [Linear Voltage Regulators](#) category:*

*Click to view products by [Analog Devices](#) manufacturer:*

Other Similar products are found below :

[LV56831P-E](#) [LV5684PVD-XH](#) [MCDTSA6-2R](#) [L7815ACV-DG](#) [LV56801P-E](#) [TCR3DF13,LM\(CT](#) [TCR3DF39,LM\(CT](#) [TLE42794G](#)  
[L78L05CZ/1SX](#) [L78LR05DL-MA-E](#) [LM317T](#) [636416C](#) [714954EB](#) [BA033LBSG2-TR](#) [LV5680P-E](#) [L78M15CV-DG](#) [L79M05T-E](#)  
[TLS202A1MBVHTSA1](#) [L78LR05D-MA-E](#) [NCV317MBTG](#) [NTE7227](#) [LV5680NPVC-XH](#) [LT1054CN8](#) [ME6208A50M3G](#) [SL7533-8](#)  
[ME6231A50M3G](#) [ME6231A50PG](#) [ME6231C50M5G](#) [AMS1117S-3.3](#) [AMS1117-5.0](#) [AMS1117S-5.0](#) [AMS1117-3.3](#) [MD5118](#) [MD5121](#)  
[MD5127](#) [MD5128](#) [MD5130](#) [MD5144](#) [MD5150](#) [MD5112](#) [MD5115](#) [MD5125](#) [MD5133](#) [MD5136](#) [MD5140](#) [MD5110](#) [MD52E18WB6](#)  
[MD52E33WB6](#) [MD52E15QA3](#) [MD52E21QA3](#)