

FEATURES

- Simple, safe linear charger for single-cell lithium battery
- 4.5 V to 12 V input voltage range
- Adjustable charging current up to 1.5 A
- Low cost PNP external pass element
- Automatic reverse isolation with no external blocking diode
- Output overshoot protection
- Deep discharge precharge mode
- Thermal shutdown
- Automatic recharge
- Programmable termination timer
- LED charging status indicator
- 4.2 V output voltage with $\pm 1\%$ accuracy over line and temperature
- 1 μA shutdown supply current
- Small, 8-lead MSOP and 3×3 mm LFCSP packages

APPLICATIONS

- Wireless handsets
- Smart handhelds and PDAs
- Digital cameras
- Single-cell, lithium ion-powered systems
- Cradle chargers

GENERAL DESCRIPTION

The ADP2291 is a constant-current/constant-voltage linear charger for a single-cell, lithium ion battery, requiring just a few components to provide a simple and safe charging system that operates from a wide 4.5 V to 12 V input voltage range. It features an internally controlled, multistep charging cycle that improves battery life.

An external, low cost PNP provides the charging current to the battery, and an external resistor sets the maximum charge current. A small, external capacitor programs the maximum charge time. The controller includes an LED driver to indicate the battery charging status.

Safety features include charging stop mode for battery faults, output overshoot protection, and thermal shutdown. The ADP2291 also features automatic reverse isolation, which does not require an additional blocking diode.

The multistep charge cycle optimizes the battery charging time in a safe manner. It features a trickle charge mode for a deeply discharged cell and a fast charging mode with a maximum current of 1.5 A. The ADP2291 controls the end of charge with a 4.2 V output voltage that is 1% accurate over line and temperature. It automatically recharges the battery if the cell voltage drops. When the input supply is removed, the part enters a low current state and reduces the current drawn from the battery to below 1 μA .

The ADP2291 is available in both a small, 8-lead MSOP package and a 3×3 mm LFCSP package that is ideally suited for small, portable applications.

TYPICAL OPERATING CIRCUIT

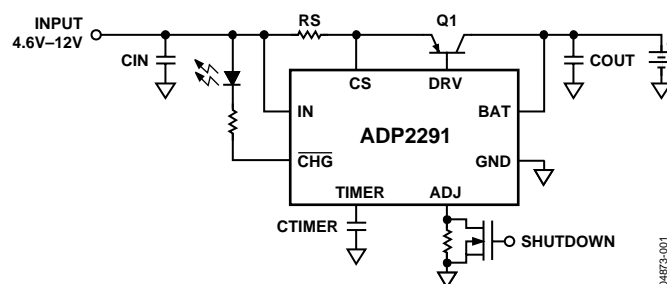

Figure 1.

Rev. A

Information furnished by Analog Devices is believed to be accurate and reliable. However, no responsibility is assumed by Analog Devices for its use, nor for any infringements of patents or other rights of third parties that may result from its use. Specifications subject to change without notice. No license is granted by implication or otherwise under any patent or patent rights of Analog Devices. Trademarks and registered trademarks are the property of their respective owners.

TABLE OF CONTENTS

Features	1	Overshoot Protection.....	10
Applications.....	1	Power Supply Checks.....	10
General Description	1	Thermal Shutdown	11
Typical Operating Circuit.....	1	Application Information.....	12
Specifications.....	3	Setting the Maximum Charge Current.....	12
Absolute Maximum Ratings.....	5	Setting the Maximum Charge Time	12
ESD Caution.....	5	External Capacitors.....	12
Pin Configurations and Function Descriptions	6	Reverse Input Protection.....	12
Typical Performance Characteristics	7	External Pass Transistor	13
Theory of Operation	10	Typical Application Circuit.....	14
Precharge Mode.....	10	Charge Termination	14
End-of-Charge Mode.....	10	Selectable Charge Current.....	14
Shutdown Mode.....	10	Thermal Protection.....	14
Charge Restart.....	10	Printed Circuit Board Layout Considerations	16
Programmable Timer.....	10	LFSCP Layout Considerations.....	16
Charge Status Indicator	10	Outline Dimensions	17
Automatic Reverse Isolation	10	Ordering Guide	17

REVISION HISTORY

11/05—Rev. 0 to Rev. A

Changes to Equation 7	13
Changes to Figure 26.....	15
Changes to Table 7.....	16
Changes to Ordering Guide	17
Updated Outline Dimensions	17

10/04—Initial Version: Revision 0

SPECIFICATIONS

$V_{IN} = 5.5\text{ V}$, $V_{BAT} = 4.2\text{ V}$, R_{ADJ} open, $T_A = -40^\circ\text{C}$ to $+85^\circ\text{C}$, typical values are at 25°C , unless otherwise noted.¹

Table 1.

Parameter	Conditions	Min	Typ	Max	Unit
POWER SUPPLY, IN					
Input Voltage		4.5		12	V
Current Draw	Fast charge/precharge/end-of-charge modes Timeout/shutdown/battery fault		6 1.4	9 1.8	mA mA
BATTERY VOLTAGE, BAT					
Voltage Accuracy, End-of-Charge ($V_{BAT, EOC}$)	$T_A = 0^\circ\text{C}$ to $+50^\circ\text{C}$ $V_{IN} = 4.5\text{ V}$ to 12 V $V_{IN} - V_{CS} = VRS/10$	4.158	4.2	4.242	V
Load Regulation, No Battery	$V_{IN} - V_{CS} = 0$ to VRS		-80		mV
Current Draw	Timeout mode, $V_{IN} = 4.5\text{ V}$ to 12 V			45	μA
Current Draw	Battery fault/shutdown mode, $V_{IN} = 4.5\text{ V}$ to 12 V		0.1	1	μA
Reverse Leakage Current	Power-down mode: $V_{IN} = \text{float}$, $V_{BAT} = 4.2\text{ V}$		0.1		μA
FAST CHARGE MODE					
Sense Voltage Setpoint (VRS)	$V_{IN} - V_{CS}$, $R_{ADJ} = \text{open}$ $V_{IN} = 4.5\text{ V}$ to 12 V $V_{BAT} = 3.6\text{ V}$	140	150	160	mV
Sense Voltage Setpoint (VRS)	$V_{IN} - V_{CS}$, $R_{ADJ} = 100\text{ k}\Omega$ $V_{IN} = 4.5\text{ V}$ to 12 V $V_{BAT} = 3.6\text{ V}$	40	50	60	mV
Current Regulation Adjustment	Per V of $(3\text{ V} - V_{ADJ})$		67		mV/V
PRECHARGE MODE					
Sense Voltage Setpoint (VRS)	$V_{IN} - V_{CS}$, $R_{ADJ} = \text{open}$ $V_{IN} = 4.5\text{ V}$ to 12 V $V_{BAT} = 2\text{ V}$	10	15	20	mV
Sense Voltage Setpoint (VRS)	$V_{IN} - V_{CS}$, $R_{ADJ} = 100\text{ k}\Omega$ $V_{IN} = 4.5\text{ V}$ to 12 V $V_{BAT} = 2\text{ V}$	5	10	15	mV
BAT Precharge Threshold	V_{BAT} rising	2.65		2.85	V
Hysteresis			70		mV
SHUTDOWN MODE					
ADJ Shutdown Threshold	V_{ADJ} falling, $V_{IN} = 4.5\text{ V}$	0.30		0.45	V
Hysteresis			40		mV
Pull-Up Current from ADJ	$V_{ADJ} = 0$		40		μA
POWER-DOWN MODE					
V_{IN} Power-Down Threshold	V_{IN} rising	3.6		4	V
Hysteresis			220		mV
V_{IN_Good} Comparator					
Threshold ($V_{IN} > V_{BAT}$)	V_{IN} rising	125	170	220	mV
Hysteresis			110		mV
EOC COMPARATOR					
Current Threshold	$V_{IN} - V_{CS}$ falling, $R_{ADJ} = \text{open}$, relative to VRS	7	10	13	%
Current Threshold	$V_{IN} - V_{CS}$ falling, $R_{ADJ} = 100\text{ k}\Omega$, relative to VRS	6	10	16	%
Hysteresis			12		mV
RESTART COMPARATOR					
BAT Restart Threshold	$V_{IN} > 4.5\text{ V}$, V_{BAT} falling, relative to $V_{BAT, EOC}$	-170			mV

ADP2291

Parameter	Conditions	Min	Typ	Max	Unit
BATTERY CHARGE TIMER					
Charge/Discharge TIMER Current		21.0	24.0	27.0	μA
Low Threshold			1.2		V
High Threshold			2.0		V
High-Low Threshold Delta ²		750		850	mV
OVERSHOOT PROTECTION					
BAT Threshold		4.7	5	5.3	V
Current Sink	<2 ms duration		1.5		A
CHG OUTPUT					
Output Voltage Low	Current = 20 mA			0.45	V
Output Leakage Current	V _{CHG} = 5 V		0.1	1	μA
BASE DRIVE CAPABILITY					
Maximum Base Drive Current		40			mA
THERMAL SHUTDOWN					
Shutdown Threshold	T _A rising		135		°C
Hysteresis			35		°C

¹ All limits at temperature extremes are guaranteed via correlation using standard statistical quality control (SQC). Typical values are at T_A = 25°C.

² Guaranteed by design; not tested in production.

ABSOLUTE MAXIMUM RATINGS

Table 2.

Parameter	Rating
IN, DRV, ¹ CS, CHG to GND	−0.3 V to +13.5 V
BAT, ADJ, TIMER to GND	−0.3 V to (V _{IN} + 0.3 V)
Operating Ambient Temperature	−40°C to +85°C
Operating Junction Temperature	−40°C to +125°C
θ_{JA} , 2-layer MSOP-8	220°C/W
θ_{JA} , 4-layer MSOP-8	158°C/W
θ_{JA} , 2-layer LFCSP-8	62°C/W
θ_{JA} , 4-layer LFCSP-8	48°C/W
Storage Temperature Range	−65°C to +150°C
Lead Temperature Soldering (10 sec)	300°C

¹Pulling current from the DRV pin by driving it below ground while VIN is applied can cause permanent damage to the device.

Stresses above those listed under Absolute Maximum Ratings may cause permanent damage to the device. This is a stress rating only and functional operation of the device at these or any other conditions above those indicated in the operational section of this specification is not implied. Exposure to absolute maximum rating conditions for extended periods may affect device reliability.

Absolute maximum ratings apply individually only, not in combination. Unless otherwise specified all other voltages referenced to GND.

ESD CAUTION

ESD (electrostatic discharge) sensitive device. Electrostatic charges as high as 4000 V readily accumulate on the human body and test equipment and can discharge without detection. Although this product features proprietary ESD protection circuitry, permanent damage may occur on devices subjected to high energy electrostatic discharges. Therefore, proper ESD precautions are recommended to avoid performance degradation or loss of functionality.



ADP2291

PIN CONFIGURATIONS AND FUNCTION DESCRIPTIONS

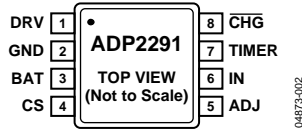

Figure 2. 8-Lead MSOP Pin Configuration

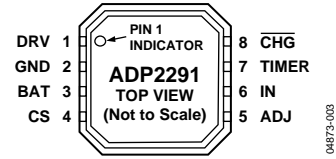

Figure 3. 8-Lead LFCSP Pin Configuration

Table 3. Pin Function Descriptions

Pin No.	Mnemonic	Description
1	DRV	Base Driver Output. Controls the base of an external PNP pass transistor.
2	GND	Ground.
3	BAT	Battery Voltage Sense Input.
4	CS	Current Sense Resistor Negative Input.
5	ADJ	Charging Current Adjust and Charger Shutdown Input.
6	IN	Power Input and Current Sense Resistor Positive Input.
7	TIMER	Timer Programming Input/Disable.
8	CHG	LED Charge Status Indicator. This is an open-collector output.

TYPICAL PERFORMANCE CHARACTERISTICS

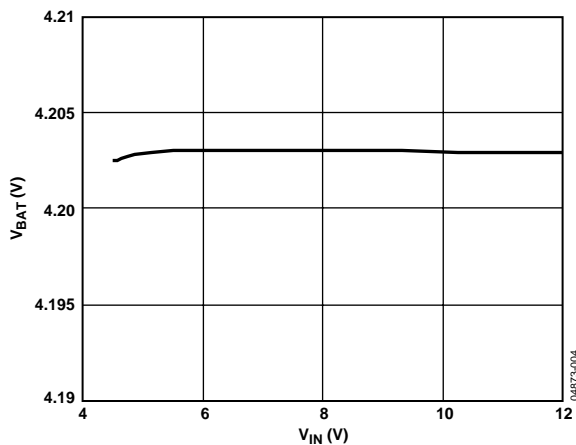

Figure 4. Battery Voltage vs. Input Voltage

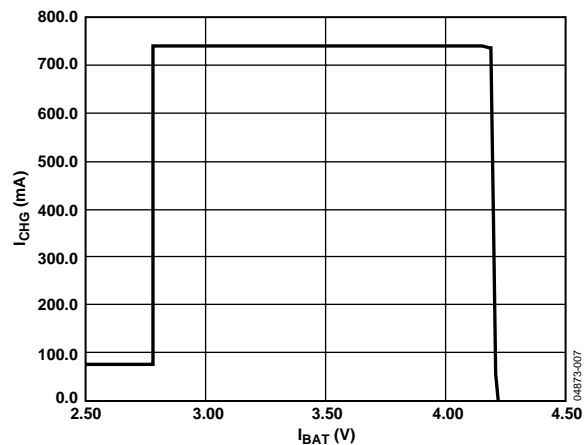

Figure 7. Charge Current vs. Battery Voltage
RS = 200 mΩ, V_{ADJ} = 3 V

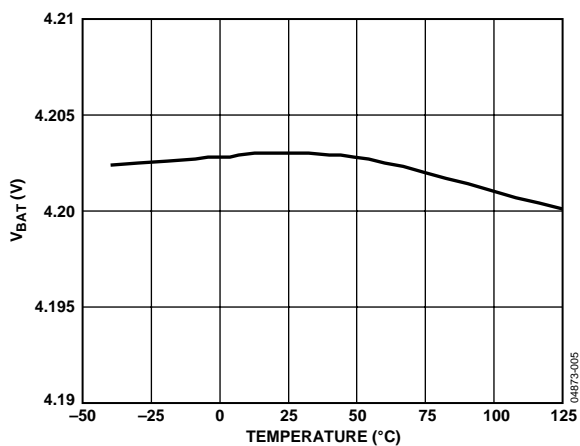

Figure 5. Battery Voltage vs. Temperature

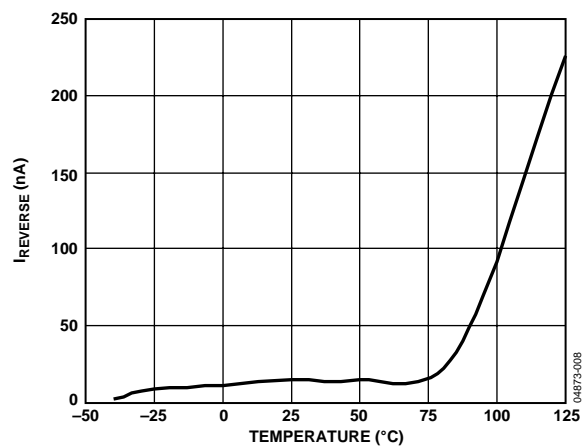

Figure 8. Battery Reverse Current vs. Temperature
V_{IN} = float, V_{BAT} = 4.2 V

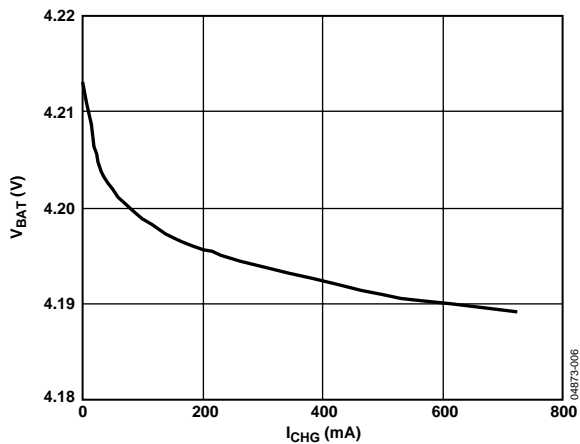

Figure 6. Battery Voltage vs. Charge Current
RS = 200 mΩ, V_{ADJ} = 3 V

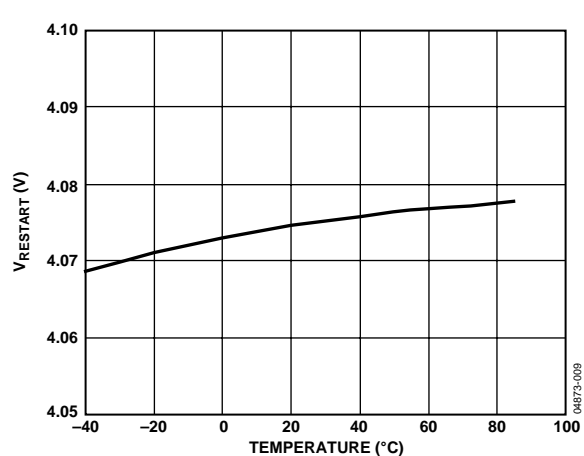

Figure 9. Restart Threshold

ADP2291

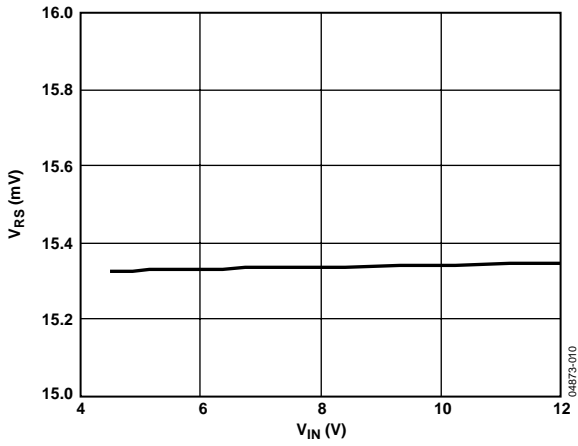

Figure 10. Precharge V_{RS} vs. Input Voltage

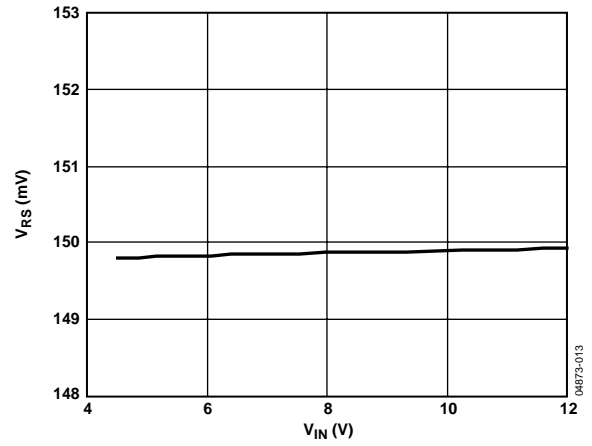

Figure 13. Fast Charge V_{RS} vs. Input Voltage

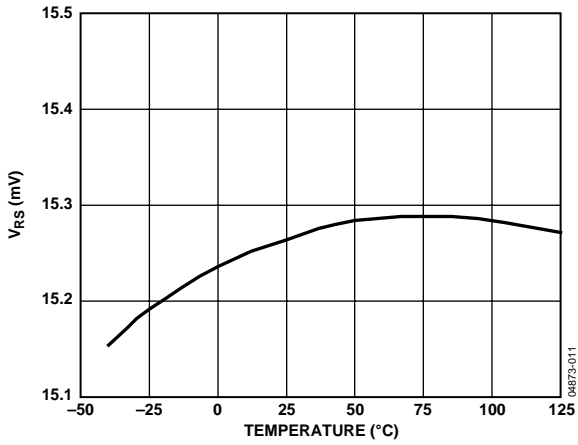

Figure 11. Precharge V_{RS} vs. Temperature

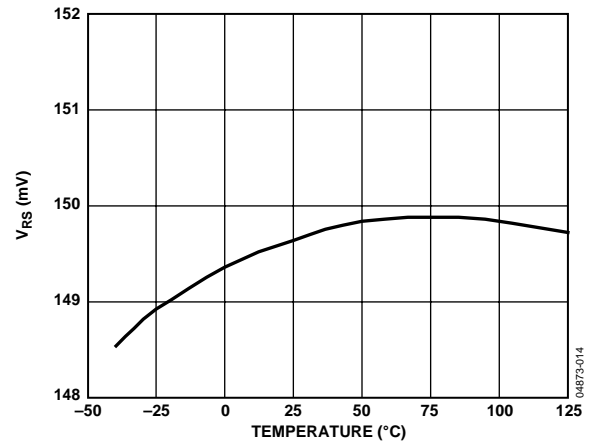

Figure 14. Fast Charge V_{RS} vs. Temperature

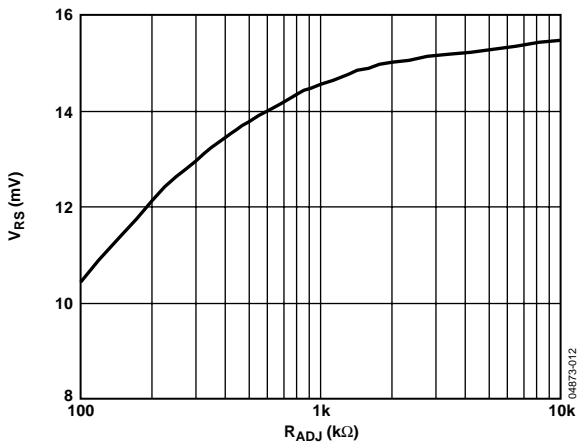

Figure 12. Precharge V_{RS} vs. R_{ADJ}

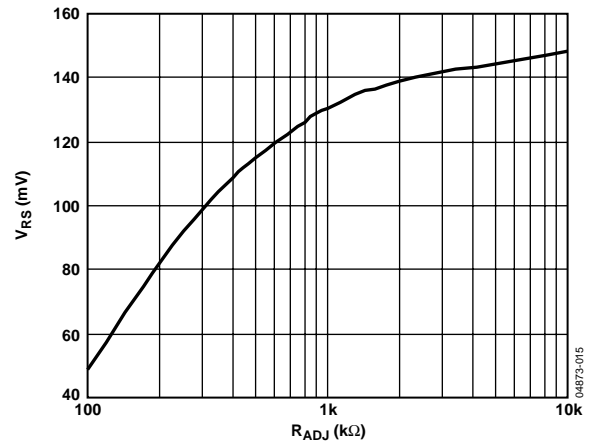

Figure 15. Fast Charge V_{RS} vs. R_{ADJ}

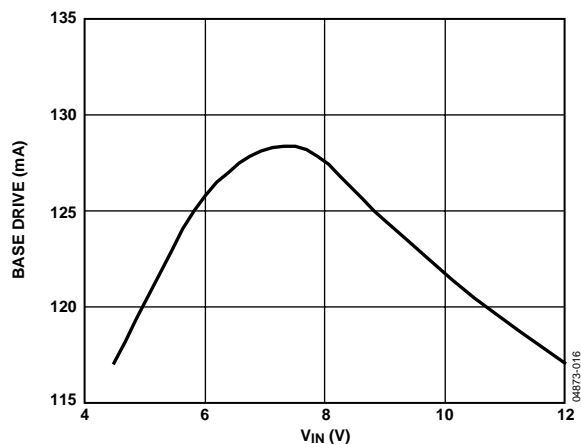

Figure 16. Base Drive vs. Input Voltage

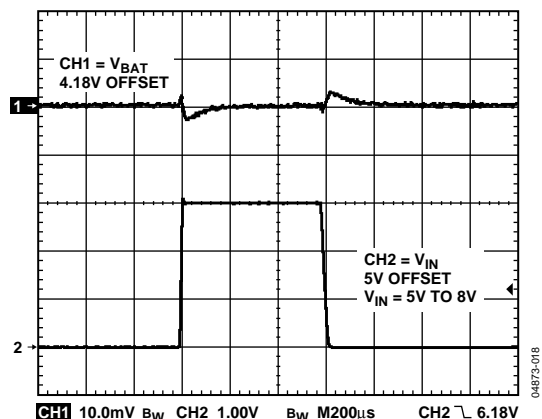

Figure 18. Line Transient Response
 $I_{BAT} = 350\text{ mA}$

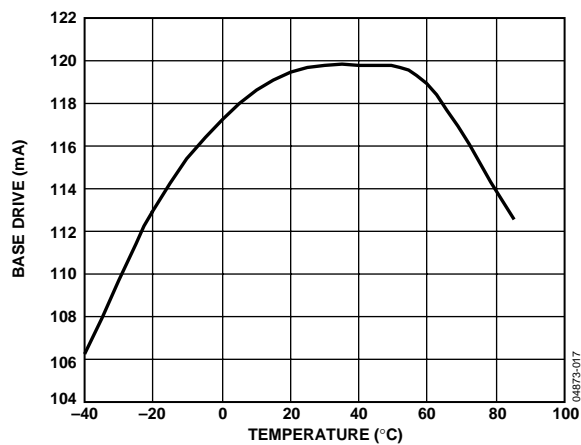

Figure 17. Base Drive vs. Temperature
 $V_{IN} = 5\text{ V}$

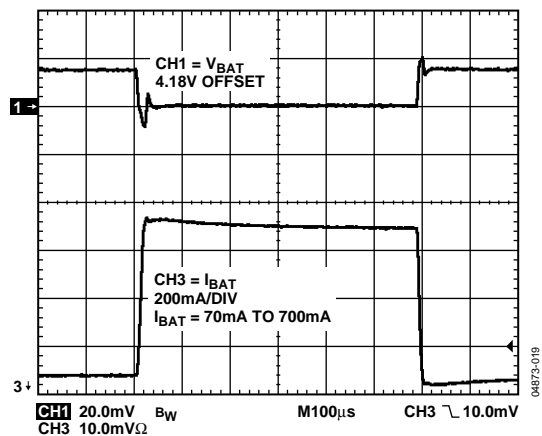

Figure 19. Load Transient Response
 $V_{IN} = 5\text{ V}$

THEORY OF OPERATION

The ADP2291 is intended to charge a single-cell, lithium battery from a supply voltage or wall adapter providing 4.5 V to 12 V. The charge controller adjusts the base current of an external PNP transistor to optimize current and voltage applied to the battery during charging. A low value resistor placed in series with the battery charging current provides current measurement for the ADP2291.

To ensure safety and long battery lifetime, the ADP2291 charges the battery using a simple step-by-step cycle, as shown in Figure 26. The normal charge cycle begins by measuring the battery voltage to determine charge level. If the battery is deeply discharged, then low current precharge is initiated. Once precharge is complete, normal fast charge at the maximum current (denoted as I_{MAX}) begins. This maximum current can be adjusted by varying the sense resistor value or by varying the voltage at the adjust pin. As the battery approaches full capacity, the charging current is reduced until the end-of-charge condition is reached. Batteries that are not deeply discharged skip the precharge mode and immediately begin fast charging. Each of these modes and associated fault conditions is discussed in detail.

PRECHARGE MODE

For deeply discharged cells, the ADP2291 charges at a reduced rate when the battery voltage $V_{BAT} < 2.8$ V. This reduced rate is $I_{MAX}/10$ when the ADJ pin voltage is 3 V and $I_{MAX}/5$ when the ADJ pin voltage is 1.5 V. For ADJ pin voltages in between 3 V and 1.5 V, the charge current can be interpolated. If the battery voltage does not increase past 2.8 V before the precharge timer elapses (typically 30 minutes), a battery fault is assumed and the ADP2291 shuts down and does not restart until the input voltage is cycled off and then back on. Note that in this mode, shutdown commands are ignored.

END-OF-CHARGE MODE

Once the voltage loop reduces the charge current to 1/10 of its nominal value, I_{MAX} (irrespective of the ADJ voltage), the ADP2291 detects the end-of-charge (EOC) state, and the charge status indicator becomes high impedance.

Low level charging continues until the timer terminates the charge (nominally 30 minutes).

SHUTDOWN MODE

When the ADJ input is pulled below 0.4 V, the ADP2291 is put into shutdown mode. When in this mode, the charger is disabled; the current drawn from the battery falls to less than 1 μ A; and the current drawn from IN falls to 0.7 mA.

When the charger is re-enabled, the charger returns to the start state but quickly sequences through the states until the proper charge mode is reached.

CHARGE RESTART

Once the charge is complete in the end-of-charge or timeout mode, the ADP2291 continually monitors the cell voltage and charge current. When the cell voltage falls by 100 mV or the charge current increases beyond the EOC hysteresis, the ADP2291 initiates another charge cycle to keep the cell fully charged. See Figure 26.

PROGRAMMABLE TIMER

The on-chip timer, controlled by an external capacitor $CTIMER$, determines the timeout intervals of the various charger modes. For example, a $CTIMER$ value of 0.1 μ F results in a precharge timeout interval of 30 minutes, a fast charge timeout of 3 hours, and an end-of-charge timeout of 30 minutes. The ratio between precharge and end-of-charge to fast charge timeout is always 1/6. All these time intervals are proportional to the $CTIMER$ capacitor value, allowing them to be adjusted over a wide range. Connecting the $TIMER$ pin to ground disables the timer.

CHARGE STATUS INDICATOR

The ADP2291 contains a charge status output, \overline{CHG} , that sinks current when the ADP2291 is charging the battery. This output can be used as a visual signal by connecting it to an LED, or it can be used to generate a logic-level charge status signal by connecting a resistor between \overline{CHG} and logic high.

AUTOMATIC REVERSE ISOLATION

When the voltage on the BAT pin is higher than the voltage on IN, the ADP2291 automatically connects the base of the pass device to BAT. This removes the necessity of having an external diode between the pass device and battery, further reducing the charger's footprint and component count.

OVERSHOOT PROTECTION

In the event of a battery disconnect during charging, a voltage overshoot condition on BAT could occur. The ADP2291 includes an overshoot protection circuit that activates when V_{BAT} rises to 5 V and sinks up to 1.5 A to protect the external components.

POWER SUPPLY CHECKS

To ensure proper operation, the ADP2291 checks the absolute voltage level of the input supply and the supply voltage relative to the battery. When the supply IN is below 3.8 V, the chip is internally powered down and does not respond to external control. In this power-down mode, the device draws less than 1 μ A from the battery. The V_{IN} good comparator halts operation if the supply voltage is less than 165 mV above the battery voltage, ensuring that charging occurs only if the supply voltage is sufficient.

THERMAL SHUTDOWN

If the ADP2291 junction temperature rises above 135°C, thermal shutdown occurs. Extreme junction temperatures can be the result of excessive current operation and/or high ambient temperatures.

A 35°C temperature hysteresis is included so that the ADP2291 does not return to operation during thermal shutdown until the on-chip temperature drops below 100°C.

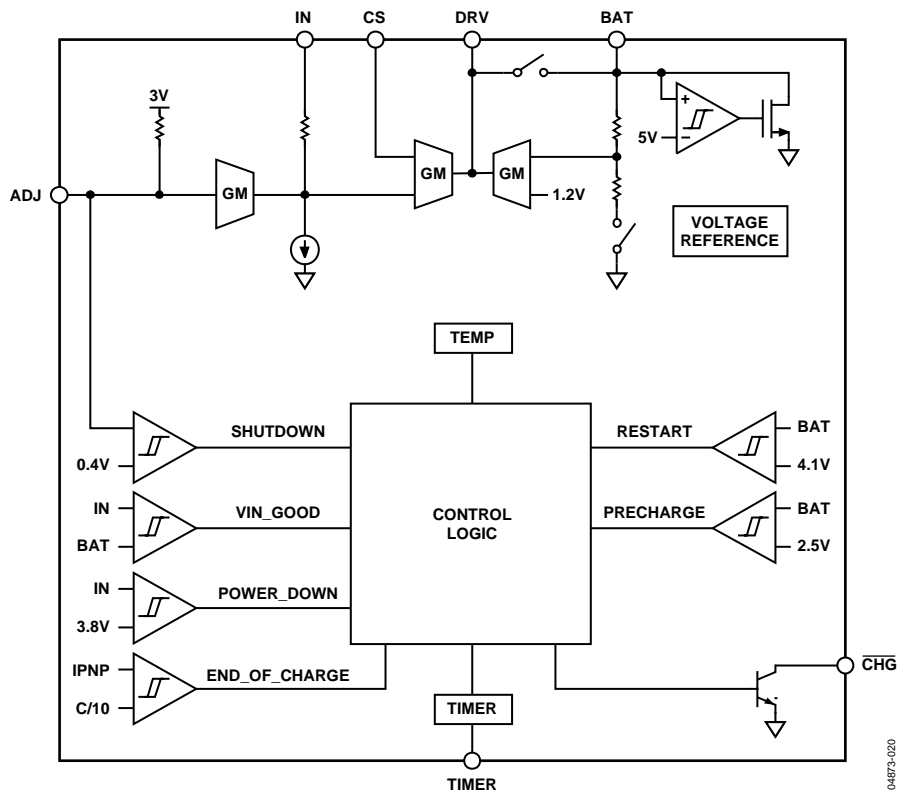

Figure 20. Functional Block Diagram

APPLICATION INFORMATION

SETTING THE MAXIMUM CHARGE CURRENT

The maximum charge current is set by choosing the proper current sense resistor, R_S , and the voltage on the ADJ input. The charger nominally regulates its output current at the point where the voltage across the current sense resistor $V_{IN} - V_{CS}$ (defined as V_{RS}) is 150 mV. This setpoint voltage can be adjusted by pulling down on the ADJ input, which is internally attached through a 100 k Ω pull-up resistor to 3 V. Each volt of pull-down from 3 V reduces V_{RS} by 67 mV during fast charge. A minimum of 50 mV is reached when a 100 k Ω resistor is attached between ADJ and ground. During slow charge, the voltage across the current sense resistor is 15 mV with no connection to ADJ, and it drops to 10 mV with a 100 k Ω resistor attached to ground. Therefore, the maximum charge rate I_{MAX} is calculated as

$$I_{MAX} = \frac{V_{RS}(\text{mV})}{R_S(\text{m}\Omega)} \quad (1)$$

where $50 \text{ mV} \leq V_{RS} \leq 150 \text{ mV}$.

After determining suitable values for V_{RS} and R_S , the value of V_{ADJ} and R_{ADJ} are calculated as

$$V_{ADJ} = \frac{V_{RS}(\text{mV}) + 50 \text{ mV}}{66.7 \text{ mV}} \text{ V} \quad (2)$$

$$R_{ADJ} = 100 \text{ k}\Omega \times \left(\frac{V_{ADJ}}{3 \text{ V} - V_{ADJ}} \right) \quad (3)$$

Examples of resistor combinations are shown in Table 4.

Table 4. Examples of R_S and R_{ADJ} Selection

I_{MAX}	$R_S \text{ m}\Omega$	$V_{RS} \text{ mV}$	$V_{ADJ} \text{ V}$	R_{ADJ}
1.5 A	100	150	3	Open
1 A	100	100	2.25	300 K
750 mA	100	75	1.87	167 K
500 mA	100	50	1.5	100 K
750 mA	200	150	3	Open
500 mA	200	100	2.25	300 K
375 mA	200	75	1.87	167 K
250 mA	200	50	1.5	100 K
500 mA	300	150	3	Open
333 mA	300	100	2.25	300 K
250 mA	300	75	1.87	167 K
167 mA	300	50	1.5	100 K

SETTING THE MAXIMUM CHARGE TIME

The maximum charge time is intended as a safety mechanism to prevent the charger from trickle charging the cell indefinitely. It does not terminate charging under normal charging conditions, but only when there is a failure to reach end-of-charge. A typical cell charges at a 1 C rate in about 1.5 hours, depending on the cell type, temperature, and manufacturer. Generally, a three-hour time limit is sufficient to prevent a normal charge cycle from being interrupted by the charge timer. It is recommended that the cell manufacturer be consulted for timing details.

The maximum charge time is set by selecting the value of the CTIMER capacitor. Calculate the timer capacitance using

$$CTIMER = t_{CHG}(\text{minutes}) \times \frac{1 \mu\text{F}}{1800 \text{ minutes}} \quad (4)$$

The precharge and end-of-charge periods are 1/6 the duration of the fast charge time limit. The charge timers are completely disabled by connecting the TIMER pin to ground. If the timers are disabled, the FAULT and TIMEOUT states are never reached, so the timers should only be disabled if charging is monitored and controlled externally.

EXTERNAL CAPACITORS

Use an input supply capacitor (CIN) with a value in the 1 μF to 10 μF range and place it close to the ADP2291. This should provide adequate input bypassing, but the selected capacitor should be checked in the actual application circuit. Check that the input voltage does not droop or overshoot excessively during the start-up transient.

Use a battery output capacitor (COUT) with a value of at least 10 μF . This capacitance provides compensation when no battery load is present. In addition, the battery and interconnections appear inductive at high frequencies and must be accounted for when the charger is operated with a battery load. Therefore, a small amount of output capacitance is necessary to compensate for the inductive nature of the battery and connections. Use a minimum output capacitance value of 1 μF for applications where the battery cannot be removed.

REVERSE INPUT PROTECTION

The Diode D1, shown in Figure 22 through Figure 25, is optional. It is required only if the input adapter voltage can be applied with a reverse polarity.

If the adapter voltage is high enough, a Schottky diode is recommended to minimize the voltage difference from the adapter to the charger input and the power dissipation. Choose a diode with a continuous current rating high enough to handle battery charging current at the maximum ambient temperature. Use a diode with a voltage rating greater than the maximum adapter voltage.

In cases where the voltage drop across the protection device must be kept low, a P MOSFET is recommended. Connect the MOSFET as shown in Figure 21.

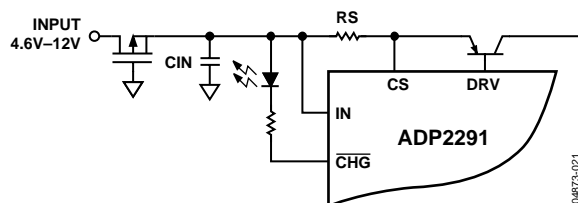

Figure 21. Reverse Input Protection

EXTERNAL PASS TRANSISTOR

Choose the external PNP pass transistor based on the given operating conditions and power handling capabilities. The pass device is determined by the base drive available, the input and output voltage, and the maximum charge current.

Select the pass transistor with a collector-emitter breakdown voltage that exceeds the maximum adapter voltage. A V_{CEO} rating of at least 15 V is recommended.

Providing a charge current of I_{MAX} with a minimum base drive of 40 mA requires a PNP beta of at least

$$\beta_{MIN} = \frac{I_{MAX}}{I_B} = \frac{I_{MAX}}{40 \text{ mA}} \quad (5)$$

Note that the beta of a transistor drops off with collector current. Therefore, make sure the beta at I_{MAX} meets the minimum requirement.

For cases where the adapter voltage is low (less than 5.5 V), calculate the saturation voltage by

$$V_{CE(SAT)} = V_{ADAPTER(MIN)} - V_{PROTECT} - V_{RS} - V_{BAT} \quad (6)$$

where $V_{PROTECT}$ is the forward drop of the reverse input protection.

The power handling capability of the PNP pass transistor is another important parameter. The maximum power dissipation of the pass transistor is estimated using

$$P_{DISS} (W) = I_{MAX} \times (V_{ADAPTER(MAX)} - V_{PROTECT} - V_{RS} - V_{BAT}) \quad (7)$$

where $V_{RS} = 50 \text{ mV}$ to 150 mV at $V_{ADJ} = 1.5 \text{ V}$ to 3.0 V , $V_{BAT} = 2.8 \text{ V}$, the lowest cell voltage where fast charge can occur.

Note that the adapter voltage can be either preregulated or unregulated. In the preregulated case, the difference between the maximum and minimum adapter voltage is small. In this case, use the maximum regulated adapter voltage to determine the maximum power dissipation. In the unregulated case, the adapter voltage can have a wide range specified. However, the maximum voltage specified is usually with no load applied. Therefore, the worst-case power dissipation calculation often leads to an over-specified pass device. In either case, it is best to determine the load characteristics of the adapter to optimize the charger design.

For example:

$$\begin{aligned} V_{ADAPTER(MIN)} &= 5.0 \text{ V} \\ V_{ADAPTER(MAX)} &= 6.0 \text{ V} \\ I_{MAX} &= 500 \text{ mA} \\ V_{PROTECT} &= 0.2 \text{ V at } 500 \text{ mA} \\ V_{ADJ} &= 3 \text{ V} \\ V_{RS} &= 150 \text{ mV} \end{aligned}$$

$$\beta_{MIN} = \frac{I_{MAX}}{I_B} = \frac{500 \text{ mA}}{40 \text{ mA}} = 12.5$$

$$\begin{aligned} V_{CE(SAT)} &= V_{ADAPTER(MIN)} - V_{PROTECT} - V_{RS} - V_{BAT} \\ &= 5.0 \text{ V} - 0.2 \text{ V} - 0.15 \text{ V} - 4.2 \text{ V} \\ &= 0.45 \text{ V} \end{aligned}$$

$$\begin{aligned} P_{DISS} (W) &= I_{MAX} \times (V_{ADAPTER(MAX)} - V_{PROTECT} - V_{RS} - V_{BAT}) \\ &= 0.50 \text{ A} \times (6.0 \text{ V} - 0.2 \text{ V} - 0.15 \text{ V} - 2.8 \text{ V}) \\ &= 1.4 \text{ W} \end{aligned}$$

A guide for selecting the PNP pass transistor is shown in Table 5.

Table 5. PNP Pass Transistor Selection Guide

Vendor	Part Number	Package	Max PD @ 25°C	Beta @ 1 A	VCE (SAT)
Fairchild	FSB6726	SuperSOT	0.5 W	150	0.5 V
	NZT45H8	SOT223	1.5 W	110	0.1 V
ON Semiconductor®	MTB35200	TSOP-6	0.625 W	200	0.175 V
	BCP53T1	SOT223	1.5 W	35	0.3 V
	MMJT9435	SOT223	1.6 W	200	0.18 V
Philips	BCP51	SOT223	1.3 W	50	0.5 V
ZETEX	ZXT10P20DE6	SOT23-6	1.1 W	270	0.17 V
	ZXT2M322	2 mm × 2 mm MLP	1.5 W	270	0.17 V
	FZT549	SOT223	2 W	130	0.25 V
	FMMT549	SOT23	0.5 W	130	0.25 V

ADP2291

TYPICAL APPLICATION CIRCUIT

A typical application circuit is shown in Figure 22. The circuit is capable of a 750 mA charge current for an input voltage of 4.5 V to 6 V. Higher input voltages can be used, but the increased power dissipation of the pass device must be taken into account.

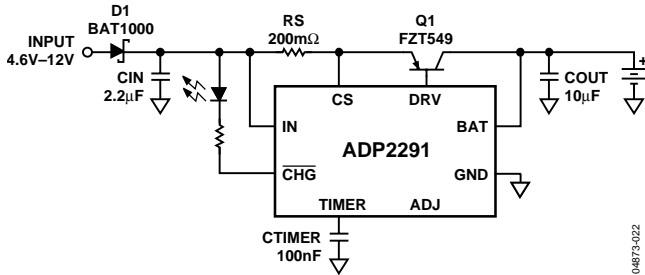

Figure 22. Typical Application Circuit

CHARGE TERMINATION

In some applications, the charger is required to terminate charging when the EOC threshold is reached. Automatic charger restart is not desired. Adding components R1, C1, and Q2 terminates charging when the CHG pin opens and prevents further charging until the adapter is removed and reasserted.

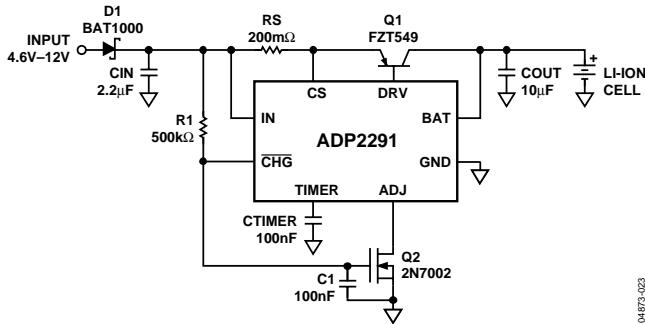

Figure 23. Self-Termination Circuit

SELECTABLE CHARGE CURRENT

In applications where the charge current needs to be selectable, use the circuit shown in Figure 24. This circuit allows a processor to determine if the charge current needs to be reduced due to an input source limitation or a different battery capacity option or simply to reduce the stress on the pass transistor. R2 and Q2 allow the charge current to be selected between high, which results in a charge current of 750 mA; and low, which results in a charge current of 250 mA.

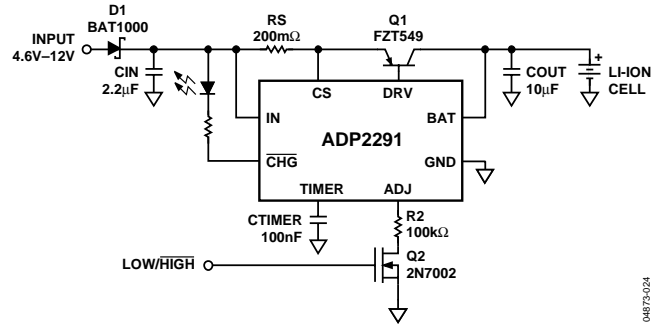

Figure 24. Selectable Charge Current Circuit

THERMAL PROTECTION

In applications where the overall size must be small or the input voltage range is wide, adding thermal regulation is suggested. This allows the charger to monitor the temperature of the pass device and decrease the charge current as the temperature increases. By adding an NTC thermistor to the ADJ pin, it is possible to accomplish this; however, care is still required to ensure that the power dissipation of the pass device is not exceeded.

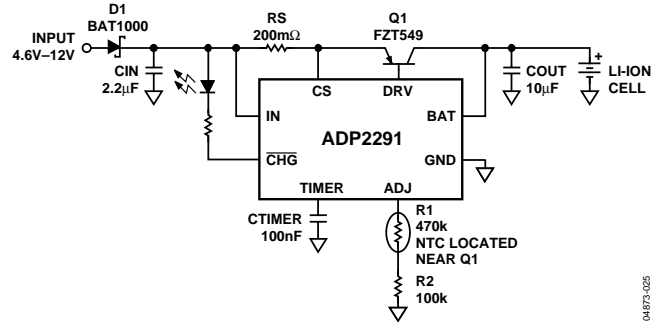
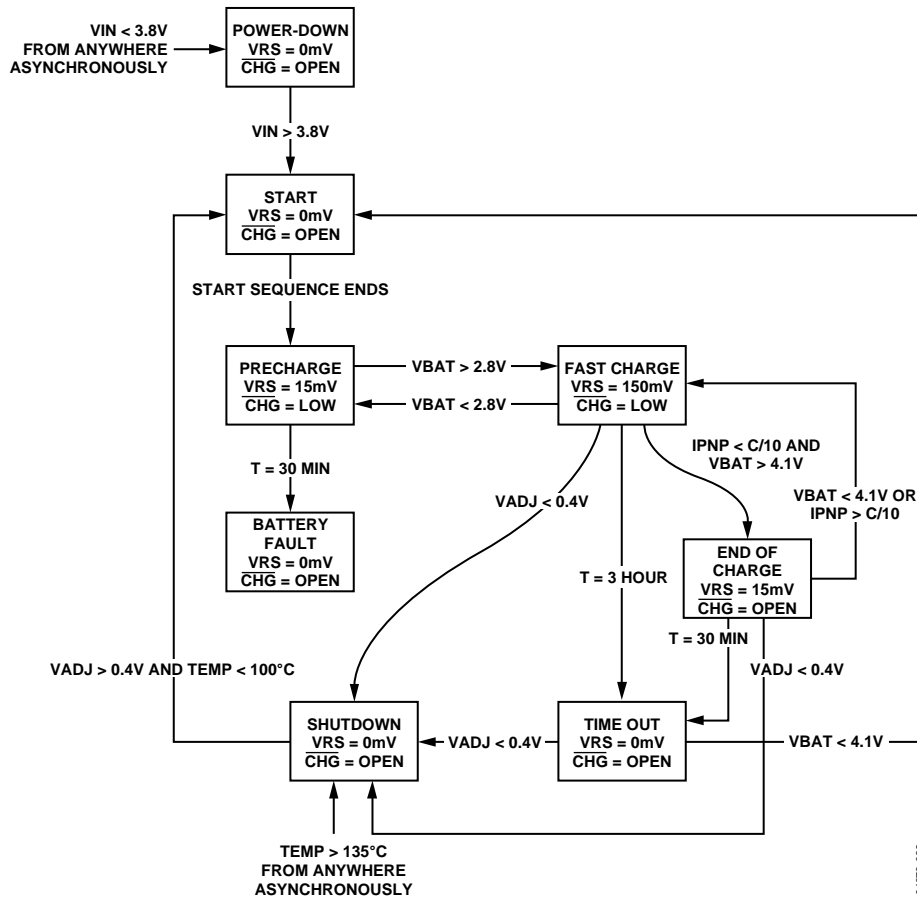

Figure 25. Thermal Regulation Circuit

Some suggested NTC thermistor suppliers are listed in Table 6.

Table 6. NTC Thermistor Manufacturers

Vendor	Part Number	Website
BetaTHERM	SMD2500KJ435J	www.betatherm.com
Murata	NCP18WM474J	www.murata.com
Panasonic	ERTJ0EV474J	www.panasonic.com
Vishay	2322 615 1.474	www.vishay.com



04873-02B

Figure 26. State Diagram for the ADP2291
CTIMER = 0.1 μF

PRINTED CIRCUIT BOARD LAYOUT CONSIDERATIONS

Use the following general guidelines when designing printed circuit boards:

- Keep the output capacitor as close to the BAT and GND pins as possible.
- Keep the input capacitor as close to the IN and GND pins as possible.
- PC board traces with larger cross-sectional areas remove more heat from the pass transistor. For optimum heat transfer, specify thick copper and use wide traces.
- Use additional copper layers or planes to reduce thermal resistance. When connecting to other layers, use multiple vias if possible.

LFCSP LAYOUT CONSIDERATIONS

The LFCSP package has an exposed die paddle on the bottom that efficiently conducts heat to the PCB. To achieve the optimum performance from the LFCSP package, give special consideration to the layout of the PCB. Use the following layout guidelines for the LFCSP package:

- The pad pattern is shown in Figure 27. Follow the pad dimension closely for reliable solder joints, while maintaining reasonable clearances to prevent solder bridging.
- The thermal pad of the LFCSP package provides a low thermal impedance path (approximately 20°C/W) to the PCB; therefore, a properly designed PCB effectively conducts the heat away from the package. This is achieved by adding thermal vias to the PCB that provide a thermal path to the inner or bottom layers.

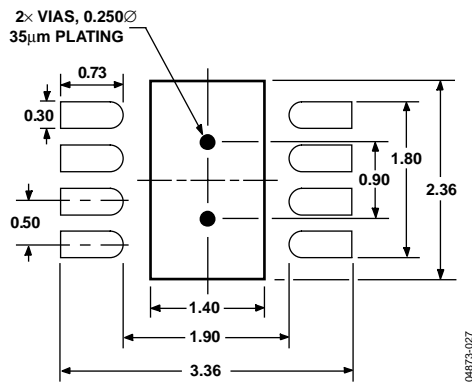

Figure 27. 3 mm × 3 mm LFCSP Pad Pattern
(Dimensions in millimeters)

Note that the via diameter is small to prevent the solder from flowing through the via and leaving voids in the thermal pad solder joint.

Note also that the thermal pad is attached to the die substrate; therefore, the thermal planes to which the vias attach the package must be electrically isolated or connected to GND.

- The solder mask opening should be about 120 microns (4.7 mils) larger than the pad size, resulting in a minimum of 60 microns (2.4 mils) clearance between the pad and the solder mask.
- The paste mask opening is typically designed to match the pad size used on the peripheral pads of the LFCSP package. This should provide a reliable solder joint as long as the stencil thickness is about 0.125 mm. The paste mask for the thermal pad needs to be designed for the maximum coverage to effectively remove the heat from the package. However, due to the presence of thermal vias and the size of the thermal pad, eliminating voids may not be possible.
- The recommended paste mask stencil thickness is 0.125 mm. Use a laser cut stainless steel stencil with trapezoidal walls.
- Use a no-clean, Type 3 solder paste for mounting the LFCSP package. A nitrogen purge during the reflow process is recommended.
- The package manufacturer recommends that the reflow temperature not exceed 220°C and the time above liquidus be less than 75 seconds. Make sure the preheat ramp is 3°C/second or lower. The actual temperature profile depends on the board's density and should be determined by the assembly house.

Table 7. Variables Description

Variable Name	Description
V_X	The voltage on Pin X.
V_{RS}	The regulation setpoint for the voltage across the sense resistor (RS).
$V_{BAT, EOC}$	The battery voltage at the point charging current is 1/10 the current setpoint.
I_{MAX}	The charge current corresponding to V_{RS} , including the effects of ADJ pin voltage.
C rate	The charge current (mA) expressed as a multiple of the nominal battery capacity (mAh). A 900 mAh capacity battery, charged at a 1/10 C rate, is equivalent to a 90 mA charge current.

OUTLINE DIMENSIONS

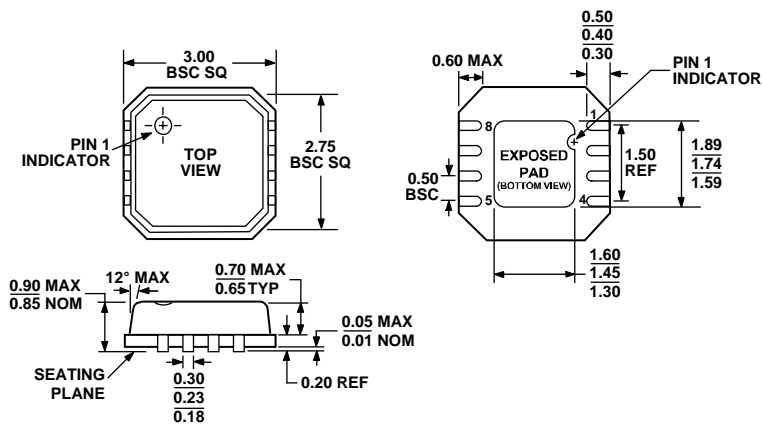
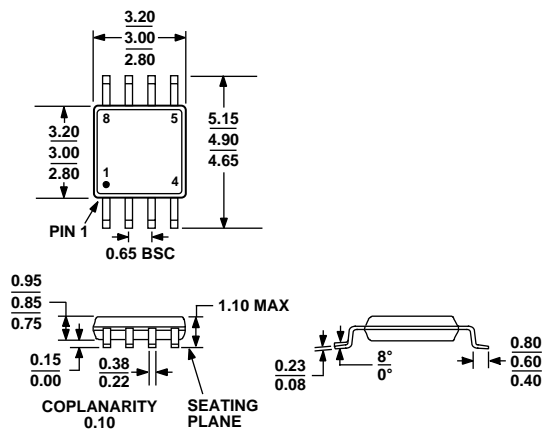

Figure 28. 8-Lead Lead Frame Chip Scale Package [LFCSP_VD]
 3 mm x 3 mm Body, Very Thin, Dual Lead
 (CP-8-2)
 Dimensions shown in millimeters



COMPLIANT TO JEDEC STANDARDS MO-187-AA

Figure 29. 8-Lead Mini Small Outline Package [MSOP]
 (RM-8)
 Dimensions shown in millimeters

ORDERING GUIDE

Model	Temperature Range	Package Description	Package Option	Branding
ADP2291ARMZ-R7 ¹	-40°C to +85°C	8-Lead MSOP	RM-8	P08
ADP2291ACPZ-R7 ¹	-40°C to +85°C	8-Lead LFCSP_VD	CP-8-2	P08
ADP2291-EVAL		Evaluation Board		

¹ Z = Pb-free part.

ADP2291

NOTES

NOTES

ADP2291

NOTES

X-ON Electronics

Largest Supplier of Electrical and Electronic Components

Click to view similar products for [Power Management IC Development Tools](#) category:

Click to view products by [Analog Devices](#) manufacturer:

Other Similar products are found below :

[EVAL-ADM1168LQEBZ](#) [EVB-EP5348UI](#) [MIC23451-AAAYFL EV](#) [MIC5281YMME EV](#) [DA9063-EVAL](#) [ADP122-3.3-EVALZ](#) [ADP130-0.8-EVALZ](#) [ADP130-1.2-EVALZ](#) [ADP130-1.5-EVALZ](#) [ADP130-1.8-EVALZ](#) [ADP1714-3.3-EVALZ](#) [ADP1716-2.5-EVALZ](#) [ADP1740-1.5-EVALZ](#) [ADP1752-1.5-EVALZ](#) [ADP1828LC-EVALZ](#) [ADP1870-0.3-EVALZ](#) [ADP1871-0.6-EVALZ](#) [ADP1873-0.6-EVALZ](#) [ADP1874-0.3-EVALZ](#) [ADP1882-1.0-EVALZ](#) [ADP199CB-EVALZ](#) [ADP2102-1.25-EVALZ](#) [ADP2102-1.875EVALZ](#) [ADP2102-1.8-EVALZ](#) [ADP2102-2-EVALZ](#) [ADP2102-3-EVALZ](#) [ADP2102-4-EVALZ](#) [ADP2106-1.8-EVALZ](#) [ADP2147CB-110EVALZ](#) [AS3606-DB](#) [BQ24010EVM](#) [BQ24075TEVM](#) [BQ24155EVM](#) [BQ24157EVM-697](#) [BQ24160EVM-742](#) [BQ24296MEVM-655](#) [BQ25010EVM](#) [BQ3055EVM](#) [NCV891330PD50GEVB](#) [ISLUSBI2CKIT1Z](#) [LM2744EVAL](#) [LM2854EVAL](#) [LM3658SD-AEV/NOPB](#) [LM3658SDEV/NOPB](#) [LM3691TL-1.8EV/NOPB](#) [LM4510SDEV/NOPB](#) [LM5033SD-EVAL](#) [LP38512TS-1.8EV](#) [EVAL-ADM1186-1MBZ](#) [EVAL-ADM1186-2MBZ](#)