

FEATURES

- Input voltage range: 2.3 V to 5.5 V
- Two 800 mA buck regulators
- Tiny, 16-ball, 2 mm × 2 mm WLCSP package
- Regulator accuracy: ±1.8%
- Factory programmable or external adjustable VOUTx
- 3 MHz buck operation with forced PWM and auto PWM/PSM modes
- BUCK1/BUCK2: output voltage range from 0.6 V to 3.8 V

APPLICATIONS

- Power for processors, ASICs, FPGAs, and RF chipsets
- Portable instrumentation and medical devices
- Space constrained devices

GENERAL DESCRIPTION

The ADP5133 combines two high performance buck regulators in a tiny, 16-ball, 2 mm × 2 mm WLCSP to meet demanding performance and board space requirements.

The high switching frequency of the buck regulators enables tiny multilayer external components and minimizes the board space. When the MODE pin is set high, the buck regulators operate in forced PWM mode. When the MODE pin is set low and the buck regulators operate in PWM mode, the load current is above a predefined threshold. When the load current falls below a predefined threshold, the regulators operate in power save mode (PSM), improving the light load efficiency.

The two bucks operate out of phase to reduce the input capacitor requirement and noise.

The regulators in the ADP5133 are activated through dedicated enable pins. The output voltages can be externally set through a resistor feedback network.

Table 1. Related Devices

| Model | Channels | Maximum Current | Package |
|---------|---|-----------------|-----------------------------------|
| ADP5023 | 2 Bucks, 1 LDO | 800 mA, 300 mA | LFCSP (CP-24-10) |
| ADP5024 | 2 Bucks, 1 LDO | 1.2 A, 300 mA | LFCSP (CP-24-10) |
| ADP5034 | 2 Bucks, 2 LDOs | 1.2 A, 300 mA | LFCSP (CP-24-10), TSSOP (RE-28-1) |
| ADP5037 | 2 Bucks, 2 LDOs | 800 mA, 300 mA | LFCSP (CP-24-10) |
| ADP5033 | 2 Bucks, 2 LDOs with 2 ENx pins | 800 mA, 300 mA | WLCSP (CB-16-8) |
| ADP5040 | 1 Buck, 2 LDOs | 1.2 A, 300 mA | LFCSP (CP-20-10) |
| ADP5041 | 1 Buck, 2 LDOs with supervisory, watchdog, manual reset | 1.2 A, 300 mA | LFCSP (CP-20-10) |
| ADP5133 | 2 Bucks with 2 ENx pins | 800 mA | WLCSP (CB-16-8) |
| ADP5134 | 2 Bucks, 2 LDOs with precision enable and power-good output | 1.2 A, 300 mA | LFCSP (CP-24-7) |

TYPICAL APPLICATION CIRCUIT

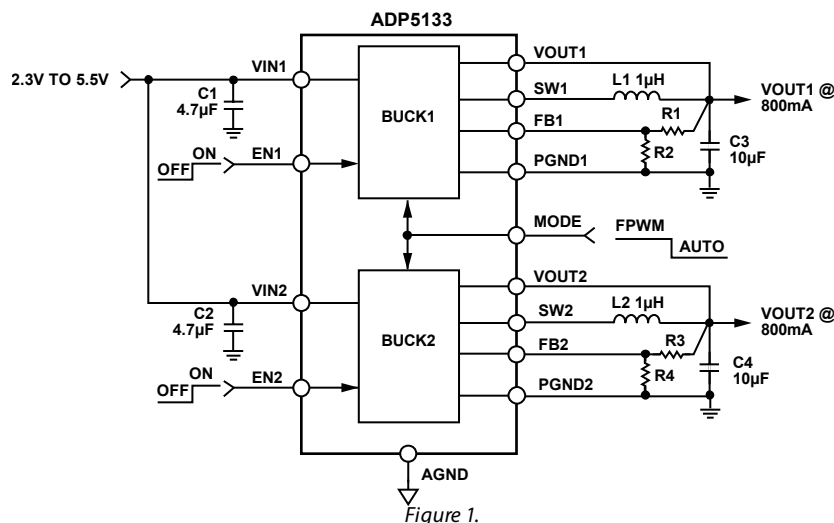

TABLE OF CONTENTS

| | | | |
|--|---|---|----|
| Features..... | 1 | Theory of Operation..... | 12 |
| Applications..... | 1 | Power Management Unit..... | 12 |
| General Description..... | 1 | BUCK1 and BUCK2..... | 13 |
| Typical Application Circuit..... | 1 | Applications Information..... | 15 |
| Revision History..... | 2 | Buck External Component Selection..... | 15 |
| Specifications..... | 3 | Power Dissipation and Thermal Considerations..... | 17 |
| General Specifications..... | 3 | Buck Regulator Power Dissipation..... | 17 |
| BUCK1 and BUCK2 Specifications..... | 4 | Junction Temperature..... | 18 |
| Input and Output Capacitor, Recommended Specifications.. | 4 | PCB Layout Guidelines..... | 19 |
| Absolute Maximum Ratings..... | 5 | Typical Application Schematics..... | 20 |
| Thermal Resistance..... | 5 | Outline Dimensions..... | 21 |
| ESD Caution..... | 5 | Ordering Guide..... | 21 |
| Pin Configuration and Function Descriptions..... | 6 | | |
| Typical Performance Characteristics..... | 7 | | |

REVISION HISTORY

4/2017—Rev. 0 to Rev. A

| | |
|---|----|
| Changes to Features Section..... | 1 |
| Changes to Table 3..... | 4 |
| Added Figure 30; Renumbered Sequentially..... | 11 |

4/2014—Revision 0: Initial Version

SPECIFICATIONS

GENERAL SPECIFICATIONS

$V_{IN1} = V_{IN2} = 2.3 \text{ V to } 5.5 \text{ V}$, $T_J = -40^\circ\text{C to } +125^\circ\text{C}$ for minimum/maximum specifications, and $T_A = 25^\circ\text{C}$ for typical specifications, unless otherwise noted.

Table 2.

| Parameter | Symbol | Test Conditions/Comments | Min | Typ | Max | Unit |
|----------------------------|--------------------|---|------|------|-------|------------------|
| INPUT VOLTAGE RANGE | V_{IN1}, V_{IN2} | | 2.3 | | 5.5 | V |
| THERMAL SHUTDOWN | | | | | | |
| Threshold | TS_{SD} | T_J rising | | 150 | | $^\circ\text{C}$ |
| Hysteresis | TS_{SD-HYS} | | | 20 | | $^\circ\text{C}$ |
| START-UP TIME ¹ | | | | | | |
| BUCK1 | t_{START1} | | | 250 | | μs |
| BUCK2 | t_{START2} | | | 300 | | μs |
| EN1, EN2, MODE INPUTS | | | | | | |
| Input Logic High | V_{IH} | | 1.1 | | | V |
| Input Logic Low | V_{IL} | | | | 0.4 | V |
| Input Leakage Current | $V_{I-LEAKAGE}$ | | | 0.05 | 1 | μA |
| STANDBY CURRENT | | | | | | |
| All Channels Enabled | $I_{STBY-NOSW}$ | No load, no buck switching | | 87 | 130 | μA |
| All Channels Disabled | $I_{SHUTDOWN}$ | $T_J = -40^\circ\text{C to } +85^\circ\text{C}$ | | 0.3 | 1 | μA |
| VIN1 UNDERVOLTAGE LOCKOUT | | | | | | |
| UVLO Input Voltage Rising | $UVLO_{VIN1RISE}$ | | | | 2.275 | V |
| UVLO Input Voltage Falling | $UVLO_{VIN1FALL}$ | | 1.95 | | | V |

¹ Start-up time is defined as the time from $V_{INk} > UVLO_{VIN1RISE}$ to V_{OUTk} reaching 90% of their nominal levels.

BUCK1 AND BUCK2 SPECIFICATIONS

$V_{IN1} = V_{IN2} = 2.3 \text{ V to } 5.5 \text{ V}$; $T_J = -40^\circ\text{C to } +125^\circ\text{C}$ for minimum/maximum specifications, and $T_A = 25^\circ\text{C}$ for typical specifications, unless otherwise noted. All limits at temperature extremes are guaranteed via correlation using standard statistical quality control (SQC).

Table 3.

| Parameter | Symbol | Test Conditions/Comments | Min | Typ | Max | Unit |
|---------------------------------|---|---|-------|------|-------|---------------|
| INPUT CHARACTERISTICS | | | | | | |
| Input Voltage Range | V_{IN1}, V_{IN2} | PWM mode, $I_{LOAD1} = I_{LOAD2} = 0 \text{ mA to } 800 \text{ mA}$ | 2.3 | | 5.5 | V |
| OUTPUT CHARACTERISTICS | | | | | | |
| Output Voltage Limit | V_{OUT1}, V_{OUT2} | $V_{IN} < 4.1 \text{ V}$ PWM mode; $I_{LOAD1} = I_{LOAD2} = 0 \text{ mA}$ PWM mode $I_{LOAD} = 0 \text{ mA to } 800 \text{ mA}$, PWM mode | 0.62 | | | V |
| Output Voltage Accuracy | V_{OUT1}, V_{OUT2} | | 0.6 | | | V |
| Line Regulation | $\Delta V_{OUT1}/V_{OUT1}, \Delta V_{OUT2}/V_{OUT2}$ $(\Delta V_{OUT1}/V_{OUT1})/\Delta V_{IN1},$ $(\Delta V_{OUT2}/V_{OUT2})/\Delta V_{IN2}$ | | -1.8 | | +1.8 | % |
| Load Regulation | $(\Delta V_{OUT1}/V_{OUT1})/\Delta I_{OUT1},$ $(\Delta V_{OUT2}/V_{OUT2})/\Delta I_{OUT2}$ | | -0.05 | | | %/V |
| VOLTAGE FEEDBACK | V_{FB1}, V_{FB2} | | 0.491 | 0.5 | 0.509 | V |
| PSM CURRENT THRESHOLD | | | | | | |
| PSM to PWM Operation | I_{PSM} | | | 100 | | mA |
| OPERATING SUPPLY CURRENT | | | | | | |
| BUCK1 Only | I_{IN} | MODE = ground $I_{LOAD1} = 0 \text{ mA}$, device not switching, all other channels disabled | | 44 | | μA |
| BUCK2 Only | | $I_{LOAD2} = 0 \text{ mA}$, device not switching, all other channels disabled | | 75 | | μA |
| BUCK1 and BUCK2 | | $I_{LOAD1} = I_{LOAD2} = 0 \text{ mA}$, device not switching | | 87 | | μA |
| SWx CHARACTERISTICS | | | | | | |
| SWx On Resistance | R_{PFET} | PFET at $V_{IN1} = 5 \text{ V}$ | | 145 | 235 | m Ω |
| | | PFET at $V_{IN1} = 3.6 \text{ V}$ | | 180 | 295 | m Ω |
| | R_{NFET} | NFET at $V_{IN1} = 5 \text{ V}$ | | 110 | 190 | m Ω |
| | | NFET at $V_{IN1} = 3.6 \text{ V}$ | | 125 | 220 | m Ω |
| Current Limit | I_{LIMIT1}, I_{LIMIT2} | PFET switch peak current limit | 1100 | 1350 | | mA |
| ACTIVE PULL-DOWN | R_{PDWN-B} | $V_{IN1} = V_{IN2} = 3.6 \text{ V}$, channels disabled | | 75 | | Ω |
| OSCILLATOR FREQUENCY | f_{SW} | | 2.5 | 3.0 | 3.5 | MHz |

INPUT AND OUTPUT CAPACITOR, RECOMMENDED SPECIFICATIONS

$T_A = -40^\circ\text{C to } +125^\circ\text{C}$, unless otherwise specified.

Table 4.

| Parameter | Symbol | Min | Typ | Max | Unit |
|---|----------------------|-------|-----|-----|---------------|
| NOMINAL INPUT AND OUTPUT CAPACITOR RATINGS | | | | | |
| BUCK1, BUCK2 Input Capacitor Rating | C_{MIN1}, C_{MIN2} | 4.7 | | 40 | μF |
| BUCK1, BUCK2 Output Capacitor Rating | C_{MIN1}, C_{MIN2} | 10 | | 40 | μF |
| CAPACITOR ESR | C_{ESR} | 0.001 | | 1 | Ω |

ABSOLUTE MAXIMUM RATINGS

Table 5.

| Parameter | Rating |
|--|-----------------------------|
| VIN1, VIN2 to AGND | −0.3 V to +6 V |
| VIN2 to VIN1 | −0.3 V to +0.3 V |
| PGND1, PGND2 to AGND | −0.3 V to +0.3 V |
| VOUT1, VOUT2, FB1, FB2 EN1, EN2, MODE to AGND | −0.3 V to (VIN1 + 0.3 V) |
| SW1 to PGND1 | −0.3 V to (VIN1 + 0.3 V) |
| SW2 to PGND2 | −0.3 V to (VIN2 + 0.3 V) |
| Storage Temperature Range | −65°C to +150°C |
| Operating Junction Temperature Range | −40°C to +125°C |
| Soldering Conditions | JEDEC J-STD-020 |

Stresses at or above those listed under Absolute Maximum Ratings may cause permanent damage to the product. This is a stress rating only; functional operation of the product at these or any other conditions above those indicated in the operational section of this specification is not implied. Operation beyond the maximum operating conditions for extended periods may affect product reliability.

For detailed information on power dissipation, see the Power Dissipation and Thermal Considerations section.

THERMAL RESISTANCE

θ_{JA} and Ψ_{JB} are specified for the worst-case conditions, that is, a device soldered in a circuit board for surface-mount packages.

Table 6. Thermal Resistance

| Package Type | θ_{JA} | Ψ_{JB} | Unit |
|-----------------------------|---------------|-------------|------|
| 16-Ball, 0.5 mm Pitch WLCSP | 57 | 14 | °C/W |

ESD CAUTION



ESD (electrostatic discharge) sensitive device. Charged devices and circuit boards can discharge without detection. Although this product features patented or proprietary protection circuitry, damage may occur on devices subjected to high energy ESD. Therefore, proper ESD precautions should be taken to avoid performance degradation or loss of functionality.

PIN CONFIGURATION AND FUNCTION DESCRIPTIONS

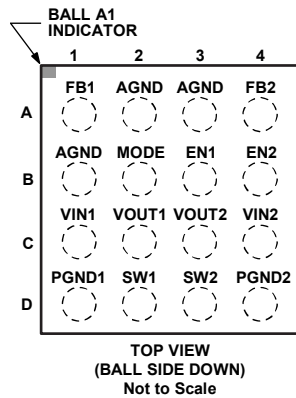

Figure 2. Pin Configuration

Table 7. Pin Function Descriptions

| Pin No. | Mnemonic | Description |
|---------|----------|---|
| A1 | FB1 | BUCK1 Feedback Input. For device models with an adjustable output voltage, connect this pin to the middle of the BUCK1 resistor divider. For device models with a fixed output voltage, leave this pin unconnected. |
| A2 | AGND | Analog Ground. |
| A3 | AGND | Analog Ground. |
| A4 | FB2 | BUCK2 Feedback Input. For device models with an adjustable output voltage, connect this pin to the middle of the BUCK2 resistor divider. For device models with a fixed output voltage, leave this pin unconnected. |
| B1 | AGND | Analog Ground. |
| B2 | MODE | BUCK1/BUCK2 Operating Mode. If MODE is set high, the buck regulators operate in forced PWM mode. If MODE is set low, the switching regulators operate in auto PWM/PSM mode. |
| B3 | EN1 | BUCK1 Enable. Active High. |
| B4 | EN2 | BUCK2 Enable. Active High. |
| C1 | VIN1 | BUCK1 Input Supply (2.3 V to 5.5 V) and UVLO Detection. Connect VIN1 to VIN2. |
| C2 | VOUT1 | BUCK1 Output Voltage Sensing Input. |
| C3 | VOUT2 | BUCK2 Output Voltage Sensing Input. |
| C4 | VIN2 | BUCK2 Input Supply (2.3 V to 5.5 V). Connect VIN2 to VIN1. |
| D1 | PGND1 | Dedicated Power Ground for BUCK1. |
| D2 | SW1 | BUCK1 Switching Node. |
| D3 | SW2 | BUCK2 Switching Node. |
| D4 | PGND2 | Dedicated Power Ground for BUCK2. |

TYPICAL PERFORMANCE CHARACTERISTICS

$V_{IN1} = V_{IN2} = 3.6\text{ V}$, $T_A = 25^\circ\text{C}$, unless otherwise noted.

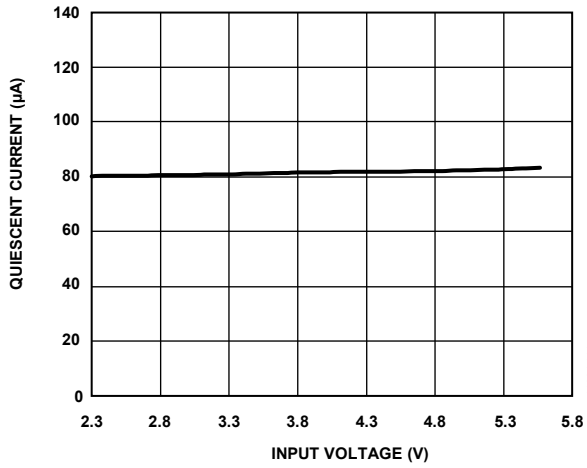

Figure 3. System Quiescent Current vs. Input Voltage, $V_{OUT1} = 1.8\text{ V}$, $V_{OUT2} = 1.8\text{ V}$, All Channels Enabled

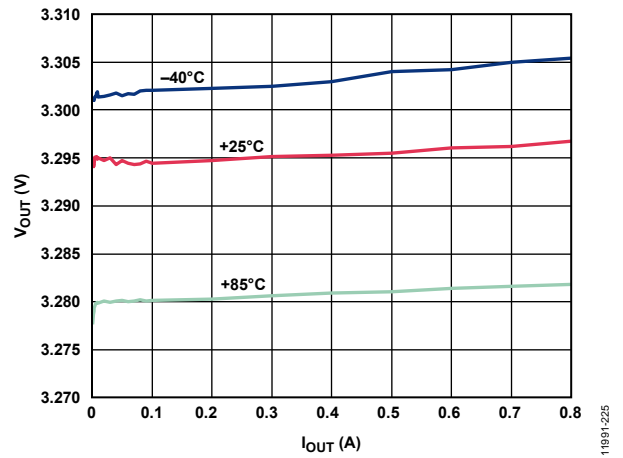

Figure 6. BUCK1 Load Regulation Across Temperature, $V_{IN} = 4.2\text{ V}$, $V_{OUT1} = 3.3\text{ V}$, PWM Mode

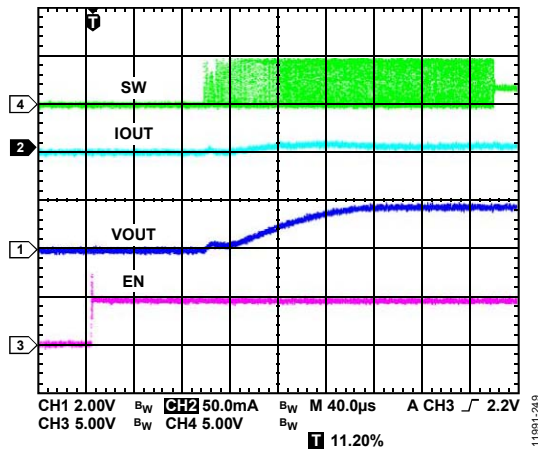

Figure 4. Buck1 Startup, $V_{OUT1} = 1.8\text{ V}$, $I_{OUT1} = 5\text{ mA}$

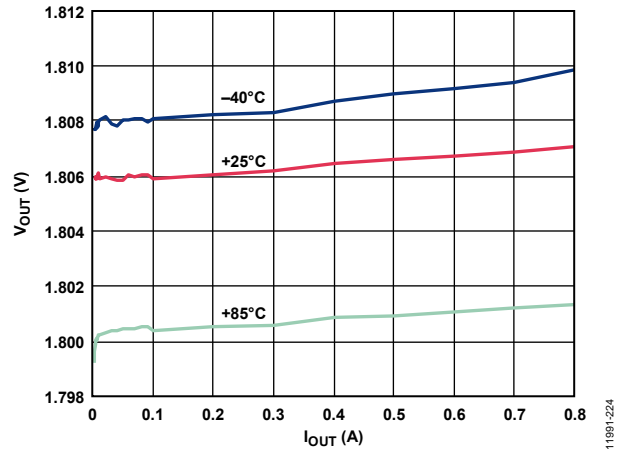

Figure 7. BUCK2 Load Regulation Across Temperature, $V_{IN} = 3.6\text{ V}$, $V_{OUT2} = 1.8\text{ V}$, PWM Mode

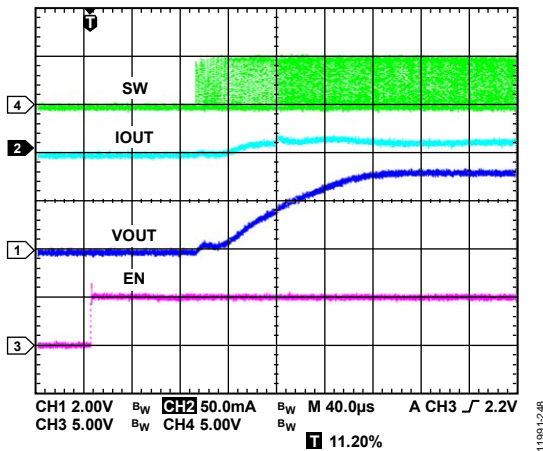

Figure 5. BUCK2 Startup, $V_{OUT2} = 3.3\text{ V}$, $I_{OUT2} = 10\text{ mA}$

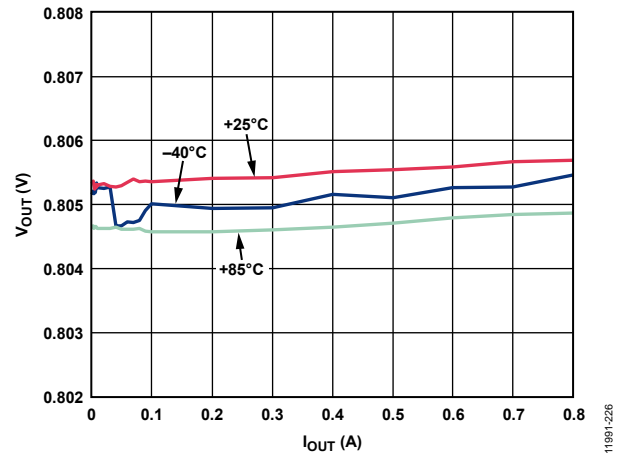

Figure 8. BUCK1 Load Regulation Across Temperature, $V_{IN} = 3.6\text{ V}$, $V_{OUT1} = 0.8\text{ V}$, PWM Mode

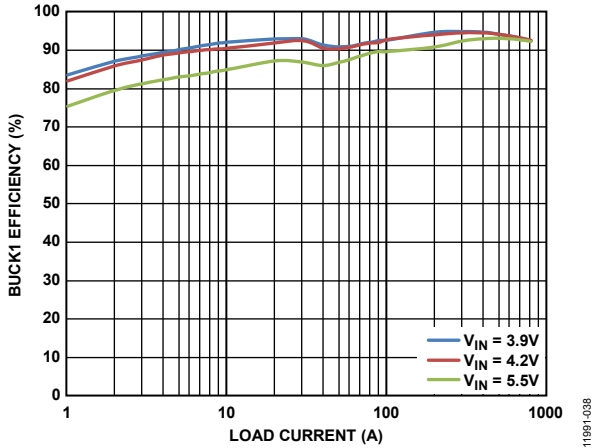

Figure 9. BUCK1 Efficiency vs. Load Current, Across Input Voltage, $V_{OUT1} = 3.3V$, Auto PWM/PSM Mode

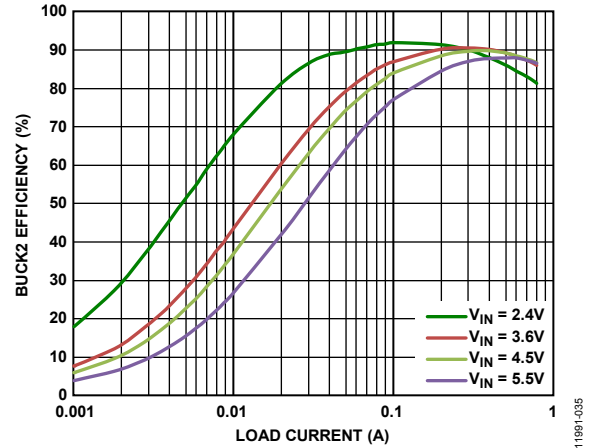

Figure 12. BUCK2 Efficiency vs. Load Current, Across Input Voltage, $V_{OUT2} = 1.8V$, PWM Mode

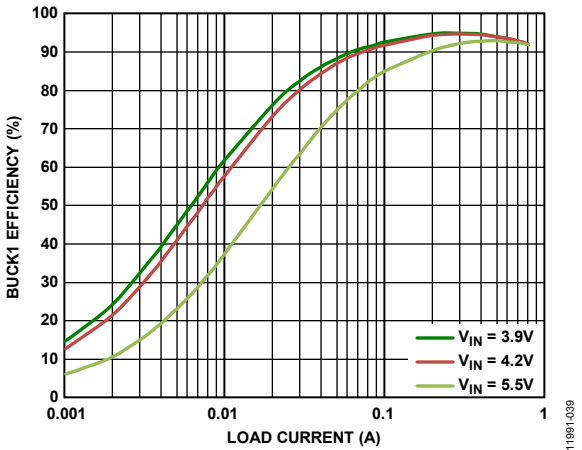

Figure 10. BUCK1 Efficiency vs. Load Current, Across Input Voltage, $V_{OUT1} = 3.3V$, PWM Mode

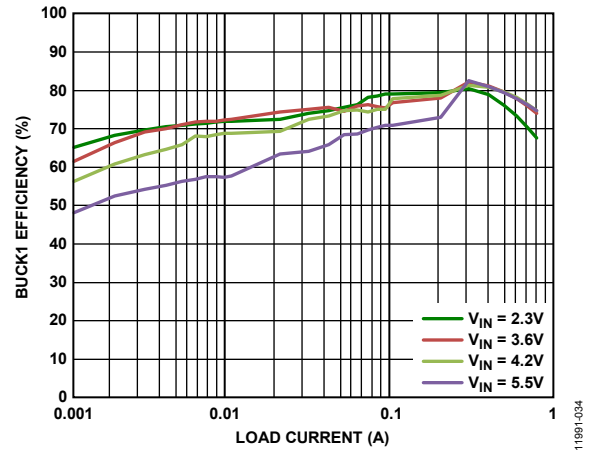

Figure 13. BUCK1 Efficiency vs. Load Current, Across Input Voltage, $V_{OUT1} = 0.8V$, Auto PWM/PSM Mode

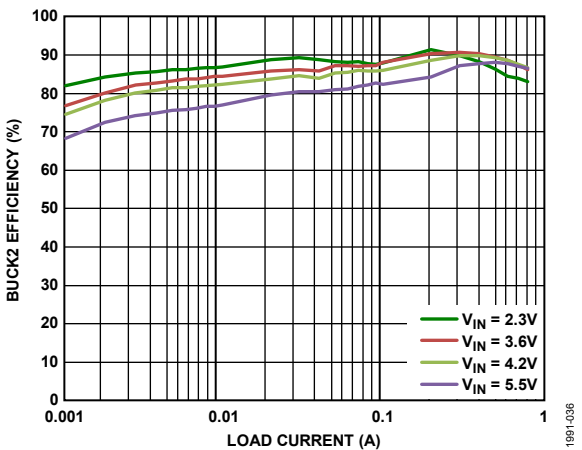

Figure 11. BUCK2 Efficiency vs. Load Current, Across Input Voltage, $V_{OUT2} = 1.8V$, Auto PWM/PSM Mode

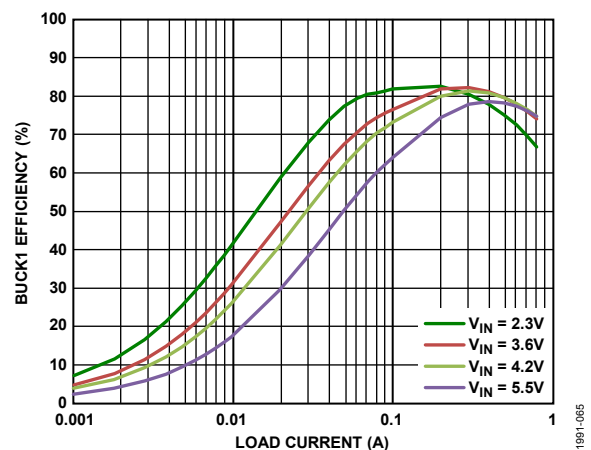

Figure 14. BUCK1 Efficiency vs. Load Current, Across Input Voltage, $V_{OUT1} = 0.8V$, PWM Mode

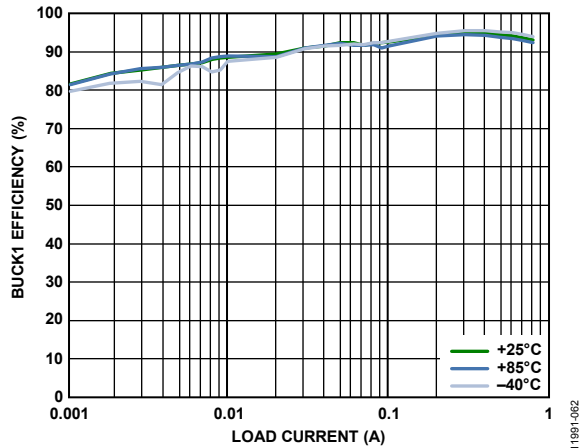

Figure 15. BUCK1 Efficiency vs. Load Current, Across Temperature, $V_{IN1} = 3.9V$, $V_{OUT1} = 3.3V$, Auto PWM/PSM Mode

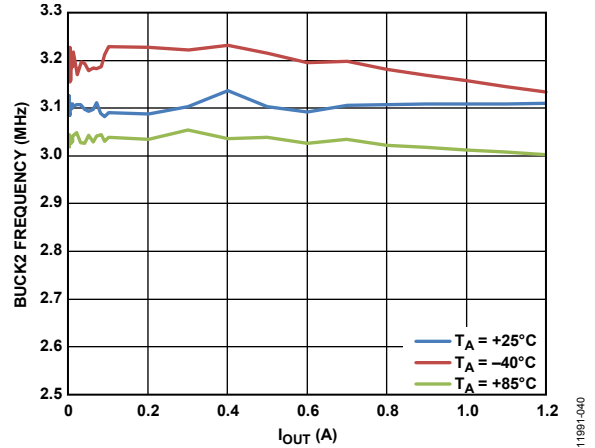

Figure 18. BUCK2 Switching Frequency vs. Output Current, Across Temperature, $V_{OUT2} = 1.8V$, PWM Mode

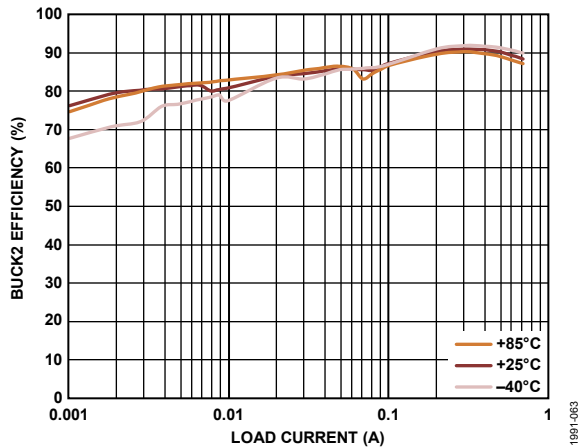

Figure 16. BUCK2 Efficiency vs. Load Current, Across Temperature, $V_{OUT2} = 1.8V$, Auto PWM/PSM Mode

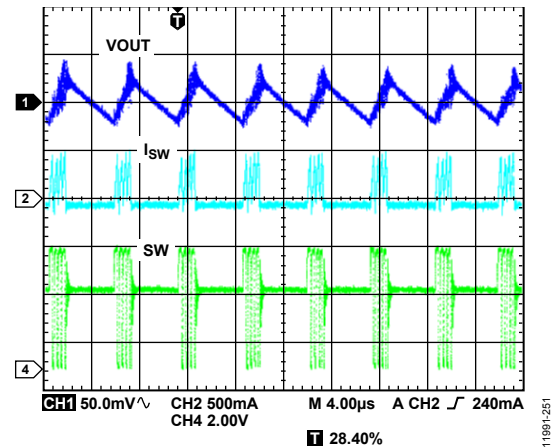

Figure 19. Typical Waveforms, $V_{OUT1} = 3.3V$, $I_{OUT1} = 30mA$, Auto PWM/PSM Mode

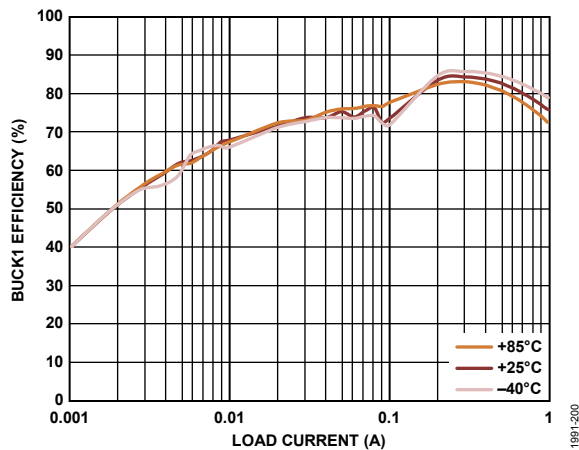

Figure 17. BUCK1 Efficiency vs. Load Current, Across Temperature, $V_{OUT1} = 0.8V$, Auto PWM/PSM Mode

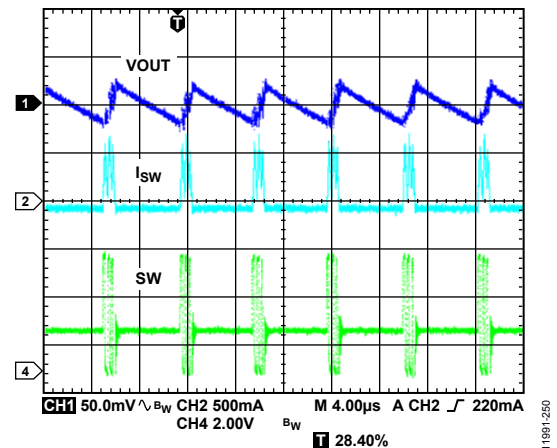

Figure 20. Typical Waveforms, $V_{OUT2} = 1.8V$, $I_{OUT2} = 30mA$, Auto PWM/PSM Mode

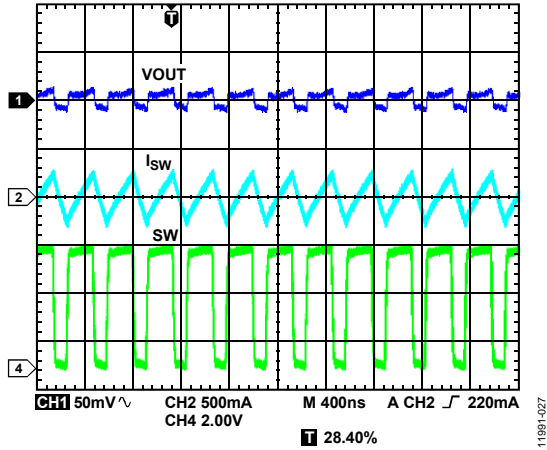

Figure 21. Typical Waveforms, $V_{OUT1} = 3.3\text{ V}$, $I_{OUT1} = 30\text{ mA}$, PWM Mode

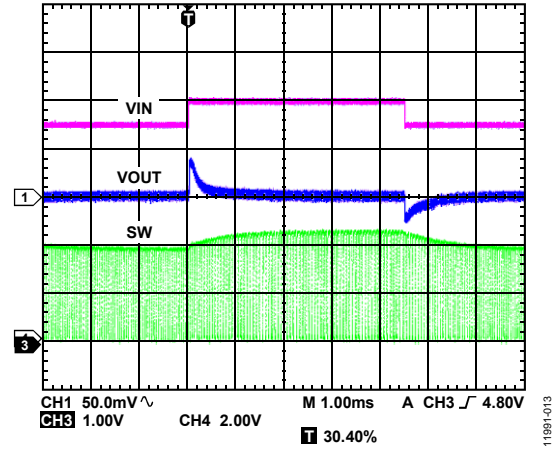

Figure 24. BUCK2 Response to Line Transient, $V_{IN} = 4.5\text{ V to } 5.0\text{ V}$, $V_{OUT2} = 1.8\text{ V}$, PWM Mode

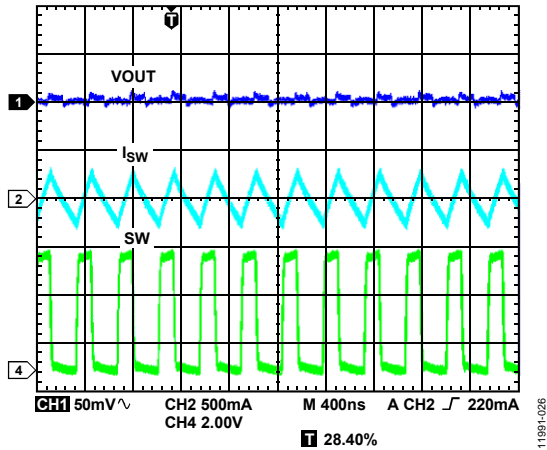

Figure 22. Typical Waveforms, $V_{OUT2} = 1.8\text{ V}$, $I_{OUT2} = 30\text{ mA}$, PWM Mode

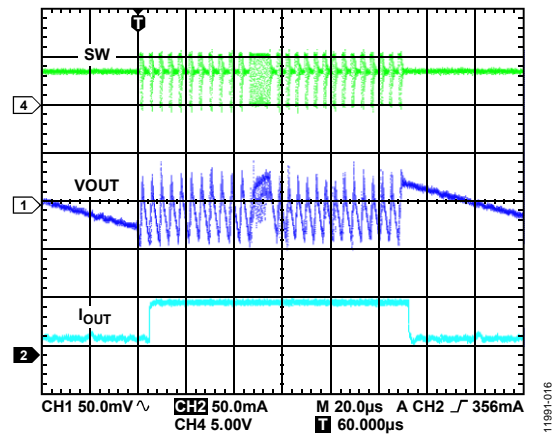

Figure 25. BUCK1 Response to Load Transient, I_{OUT1} from $1\text{ mA to } 50\text{ mA}$, $V_{OUT1} = 3.3\text{ V}$, Auto PWM/PSM Mode

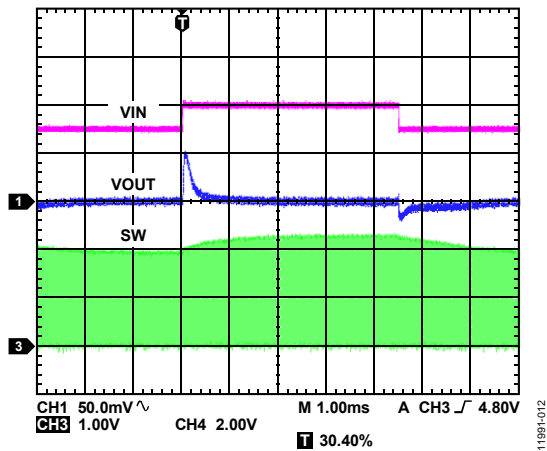

Figure 23. Buck1 Response to Line Transient, Input Voltage from $4.5\text{ V to } 5.0\text{ V}$, $V_{OUT1} = 3.3\text{ V}$, PWM Mode

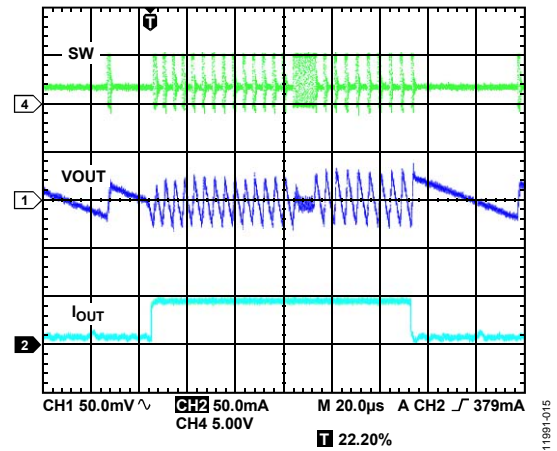

Figure 26. BUCK2 Response to Load Transient, I_{OUT2} from $1\text{ mA to } 50\text{ mA}$, $V_{OUT2} = 1.8\text{ V}$, Auto PWM/PSM Mode

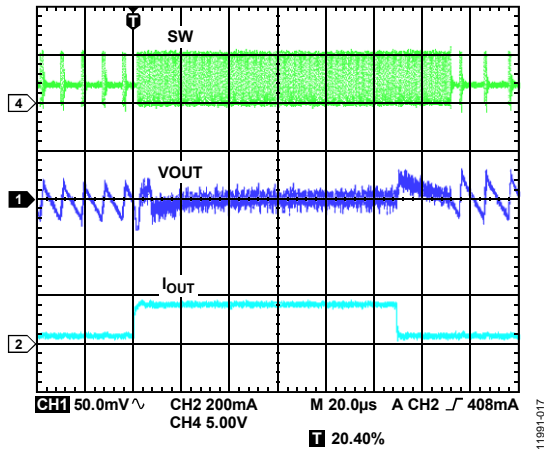

Figure 27. BUCK1 Response to Load Transient, I_{OUT1} from 20 mA to 180 mA, $V_{OUT1} = 3.3$ V, Auto PWM/PSM Mode

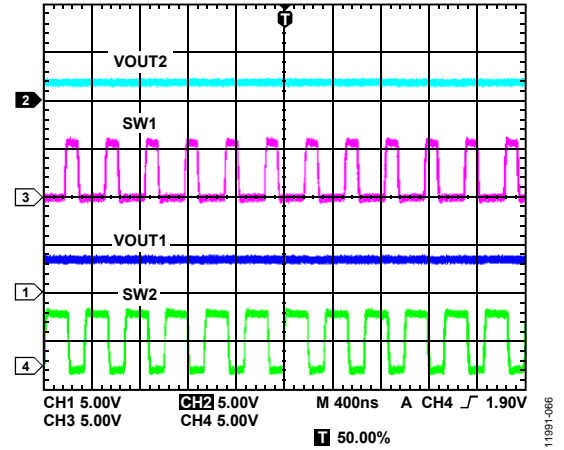

Figure 29. V_{OUTx} and SWx Waveforms for BUCK1 and BUCK2 in PWM Mode Showing Out-of-Phase Operation

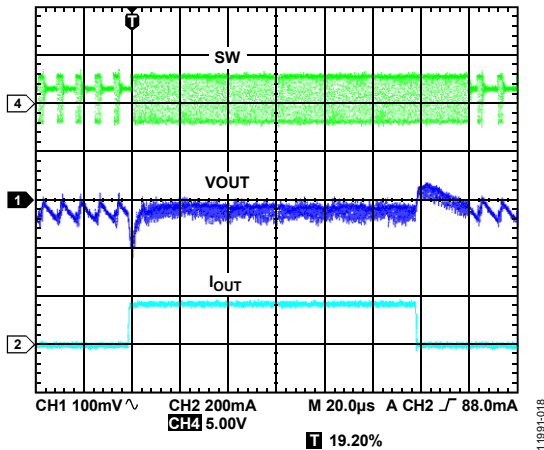

Figure 28. BUCK2 Response to Load Transient, I_{OUT2} from 20 mA to 180 mA, $V_{OUT2} = 1.8$ V, Auto PWM/PSM Mode

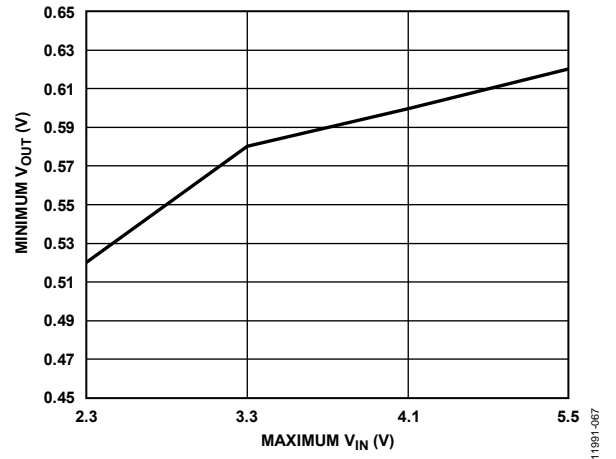

Figure 30. BUCK1 and BUCK2 Min V_{OUT} vs. Max V_{IN} Across a Temperature Range of -40°C to $+125^{\circ}\text{C}$

THEORY OF OPERATION

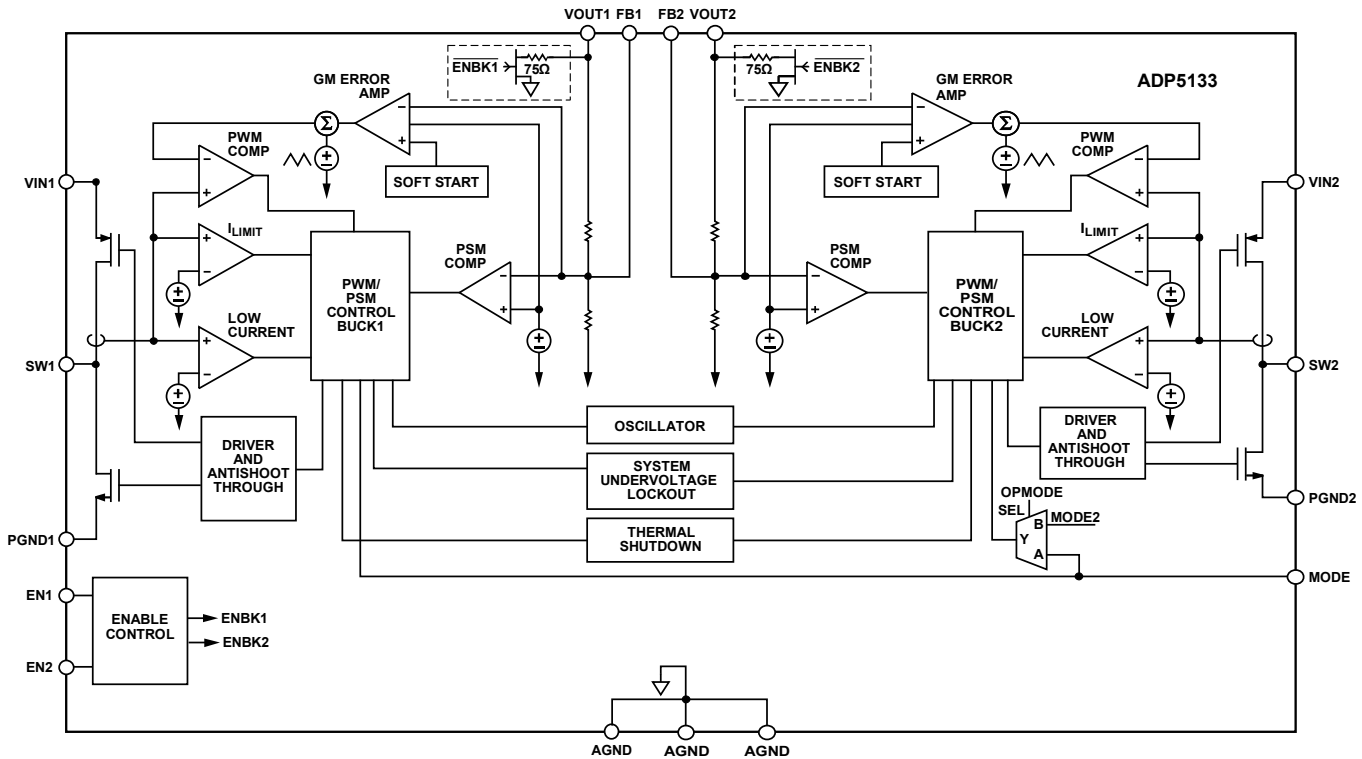

Figure 31. Functional Block Diagram

POWER MANAGEMENT UNIT

The ADP5133 is a micropower management unit (micro PMU) combining two step-down (buck) dc-to-dc converters. The high switching frequency and tiny 16-ball WLCSP package allow a small power management solution.

To combine these high performance regulators into the micro PMU, there is a system controller allowing them to operate together.

The buck regulators can operate in forced PWM mode if the MODE pin is at a logic high level. In forced PWM mode, the buck switching frequency is always constant and does not change with the load current. If the MODE pin is at logic low, the switching regulators operate in auto PWM/PSM mode. In this mode, the regulators operate at a fixed PWM frequency when the load current is above the power saving current threshold. When the load current falls below the power save current threshold, the regulators enter PSM where the switching occurs in bursts. The burst repetition is a function of the current load and the output capacitor value. This operating mode reduces the switching and quiescent current losses.

The auto PWM/PSM mode transition is controlled independently for each buck regulator. The two bucks operate synchronized to each other.

When a regulator is turned on, the output voltage ramp is controlled through a soft start circuit to avoid a large inrush current due to the charging of the output capacitors.

Thermal Protection

In the event that the junction temperature rises above 150°C, the thermal shutdown circuit turns off all the regulators. Extreme junction temperatures can be the result of high current operation, poor circuit board design, or high ambient temperature. A 20°C hysteresis is included so that when thermal shutdown occurs, the regulators do not return to operation until the on-chip temperature drops below 130°C. When coming out of thermal shutdown, all regulators restart with soft start control.

Undervoltage Lockout

To protect against battery discharge, undervoltage lockout (UVLO) circuitry is integrated in the system. If the input voltage on VIN1 drops below a typical 2.15 V UVLO threshold, all channels shut down. In the buck channels, both the power switch and the synchronous rectifier turn off. When the voltage on VIN1 rises above the UVLO threshold, the device is enabled again.

Alternatively, the user can request a new device model with a UVLO set at a higher level, suitable for 5 V supply applications. For these models, the device reaches the turn-off threshold when the input supply drops to 3.65 V typical. To order a device with options other than the default options listed in the Ordering Guide section, contact your local Analog Devices, Inc., sales or distribution representative.

In case of a thermal or UVLO event, the active pull-down resistors are enabled to discharge the output capacitors quickly. The pull-down resistors remain engaged until the thermal fault event is no longer present or the input supply voltage falls below the power on reset voltage (V_{POR}) voltage level. The typical value of V_{POR} is approximately 1 V.

Enable/Shutdown

The ADP5133 has two enable pins (EN1 and EN2). EN1 and EN2 are active high pins that enable BUCK1 and BUCK2, respectively.

Figure 33 shows the regulator activation timings for the ADP5133 when both enables are connected to VINx. Figure 33 also shows the active pull-down activation.

BUCK1 AND BUCK2

The two bucks use a fixed frequency and high speed current mode architecture. The bucks operate with an input voltage of 2.3 V to 5.5 V.

The buck regulator output voltage is resistor programmable from 0.8 V to 3.8 V, shown in Figure 32 for BUCK1. The ratio of R1 and R2 multiplied by the feedback voltage determines the voltage level at the output. If for example, R1 and R2 were chosen to have equal resistance values, the output voltage is set to 1.0 V. V_{FB1} is 0.5 V.

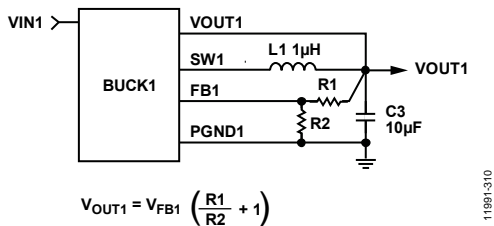

Figure 32. BUCK1 External Output Voltage Setting

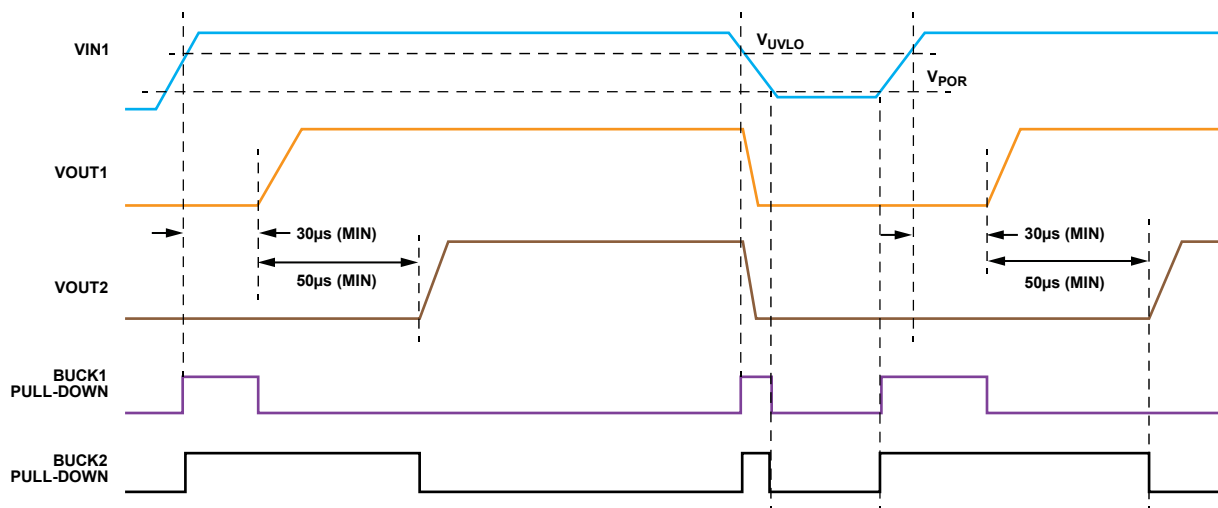

Figure 33. Regulators Sequencing on the ADP5133 (ENx = VINx)

Control Scheme

The bucks operate with a fixed frequency, current mode PWM control architecture at medium to high loads for high efficiency but shift to a PSM control scheme at light loads to lower the regulation power losses. When operating in fixed frequency PWM mode, the duty cycle of the integrated switches is adjusted and regulates the output voltage. When operating in PSM at light loads, the output voltage is controlled in a hysteretic manner, with higher output voltage ripple. During part of this time, the converter can stop switching and enters an idle mode, which improves conversion efficiency.

PWM Mode

In PWM mode, the bucks operate at a fixed frequency of 3 MHz set by an internal oscillator. At the start of each oscillator cycle, the PFET switch is turned on, which sends a positive voltage across the inductor. Current in the inductor increases until the current sense signal crosses the peak inductor current threshold that turns off the PFET switch and turns on the NFET synchronous rectifier. This sends a negative voltage across the inductor, causing the inductor current to decrease. The synchronous rectifier stays on for the rest of the cycle. The buck regulates the output voltage by adjusting the peak inductor current threshold.

Auto PSM/PWM Operation

The bucks smoothly transition to PSM operation when the load current decreases below the PSM current threshold. When either of the bucks enters PSM, an offset is induced in the PWM regulation level, which makes the output voltage rise. When the output voltage reaches a level approximately 1.5% above the PWM regulation level, PWM operation is turned off. At this point, both power switches are off, and the buck enters an idle mode. The output capacitor discharges until the output voltage falls to the PWM regulation voltage, at which point the device drives the inductor to make the output voltage rise again to the upper threshold. This process repeats while the load current is below the PSM current threshold.

The ADP5133 has a dedicated MODE pin controlling the PSM and PWM operation. A high logic level applied to the MODE pin forces both bucks to operate in PWM mode. A logic level low sets the bucks to operate in auto PSM/PWM.

PSM Current Threshold

The PSM current threshold is set to 100 mA. The bucks employ a scheme that enables this current to remain accurately controlled, independent of input and output voltage levels. This scheme also ensures that there is very little hysteresis between the PSM current threshold for entry to and exit from the PSM. The PSM current threshold is optimized for excellent efficiency over all load currents.

Oscillator/Phasing of Inductor Switching

The ADP5133 ensures that both bucks operate at the same switching frequency when both bucks are in PWM mode.

Additionally, the ADP5133 ensures that when both bucks are in PWM mode, they operate out of phase, whereby the BUCK2 PFET starts conducting exactly half a clock period after the BUCK1 PFET starts conducting.

Short-Circuit Protection

The bucks include frequency foldback to prevent output current runaway on a hard short. When the voltage at the feedback pin falls below half the target output voltage, indicating the possibility

of a hard short at the output, the switching frequency is reduced to half the internal oscillator frequency. The reduction in the switching frequency allows more time for the inductor to discharge, preventing a runaway of output current.

Soft Start

The bucks have an internal soft start function that ramps the output voltage in a controlled manner upon startup, thereby limiting the inrush current. This prevents possible input voltage drops when a battery or a high impedance power source is connected to the input of the converter.

Current Limit

Each buck has protection circuitry to limit the amount of positive current flowing through the PFET switch and the amount of negative current flowing through the synchronous rectifier. The positive current limit on the power switch limits the amount of current that can flow from the input to the output. The negative current limit prevents the inductor current from reversing direction and flowing out of the load.

100% Duty Operation

With a dropping input voltage or with an increase in load current, the buck may reach a limit where, even with the PFET switch on 100% of the time, the output voltage drops below the desired output voltage. At this limit, the buck transitions to a mode where the PFET switch stays on 100% of the time. When the input conditions change again and the required duty cycle falls, the buck immediately restarts PWM regulation without allowing overshoot on the output voltage.

Active Pull-Downs

All regulators have active pull-down resistors discharging the respective output capacitors when the regulators are disabled by the ENx pins or by a faulty condition. The pull-down resistors are connected between VOUTx and AGND. Active pull-downs are disabled when the regulators are turned on. The typical value of the pull-down resistor is 75 Ω . Figure 33 shows the activation timings for the active pull-down during regulator activation and deactivation.

APPLICATIONS INFORMATION

BUCK EXTERNAL COMPONENT SELECTION

Trade-offs between performance parameters such as efficiency and transient response can be made by varying the choice of external components in the application circuit, as shown in Figure 1.

Feedback Resistors

For the adjustable model (see Figure 32), the total combined resistance for R1 and R2 is not to exceed 400 kΩ.

Inductor

The high switching frequency of the ADP5133 bucks allows for the selection of small chip inductors. For best performance, use inductor values between 0.7 μH and 3 μH. Suggested inductors are shown in Table 8.

The peak-to-peak inductor current ripple is calculated using the following equation:

$$I_{RIPPLE} = \frac{V_{OUT} \times (V_{INx} - V_{OUTx})}{V_{IN} \times f_{SW} \times L}$$

where:

f_{SW} is the switching frequency.

L is the inductor value.

The minimum dc current rating of the inductor must be greater than the inductor peak current. The inductor peak current is calculated using the following equation:

$$I_{PEAK} = I_{LOAD(MAX)} + \frac{I_{RIPPLE}}{2}$$

Inductor conduction losses are caused by the flow of current through the inductor, which has an associated internal dc resistance (DCR). Larger sized inductors have smaller DCR, which may decrease inductor conduction losses. Inductor core losses are related to the magnetic permeability of the core material. Because the bucks are high switching frequency dc-to-dc converters, shielded ferrite core material is recommended for its low core losses and low EMI.

Table 8. Suggested 1.0 μH Inductors

| Vendor | Model | Dimensions (mm) | I _{SAT} (mA) | DCR (mΩ) |
|-------------|------------------|------------------|-----------------------|----------|
| Murata | LQM2MPN1R0NG0B | 2.0 × 1.6 × 0.9 | 1400 | 85 |
| Murata | LQM18FN1R0M00B | 1.6 × 0.8 × 0.8 | 150 | 26 |
| Taiyo Yuden | BRC1608T1R0M | 1.6 × 0.8 × 0.8 | 520 | 180 |
| Coilcraft | EPL2014-102ML | 2.0 × 2.0 × 1.4 | 900 | 59 |
| TDK | GLFR1608T1R0M-LR | 1.6 × 0.8 × 0.8 | 230 | 80 |
| Coilcraft | 0603LS-102 | 1.8 × 1.69 × 1.1 | 400 | 81 |
| Toko | MDT2520-CN | 2.5 × 2.0 × 1.2 | 1350 | 85 |

Output Capacitor

Higher output capacitor values reduce the output voltage ripple and improve load transient response. When choosing this value, it is also important to account for the loss of capacitance due to output voltage dc bias.

Ceramic capacitors are manufactured with a variety of dielectrics, each with a different behavior over temperature and applied voltage. Capacitors must have a dielectric adequate to ensure the minimum capacitance over the necessary temperature range and dc bias conditions. X5R or X7R dielectrics with a voltage rating of 6.3 V or 10 V are recommended for best performance. Y5V and Z5U dielectrics are not recommended for use with any dc-to-dc converter because of their poor temperature and dc bias characteristics.

The worst-case capacitance accounting for capacitor variation over temperature, component tolerance, and voltage is calculated using the following equation:

$$C_{EFF} = C_{OUT} \times (1 - TEMPCO) \times (1 - TOL)$$

where:

C_{EFF} is the effective capacitance at the operating voltage.

C_{OUT} is the output capacitance.

$TEMPCO$ is the worst-case capacitor temperature coefficient.

TOL is the worst-case component tolerance.

In this example, the worst-case capacitor temperature coefficient (TEMPCO) over -40°C to +85°C is assumed to be 15% for an X5R dielectric. The tolerance of the capacitor (TOL) is assumed to be 10%, and C_{OUT} is 9.2 μF at 1.8 V, as shown in Figure 34.

Substituting these values in the equation yields

$$C_{EFF} = 9.2 \mu\text{F} \times (1 - 0.15) \times (1 - 0.1) \approx 7.0 \mu\text{F}$$

To guarantee the performance of the bucks, it is imperative that the effects of dc bias, temperature, and tolerances on the behavior of the capacitors be evaluated for each application.

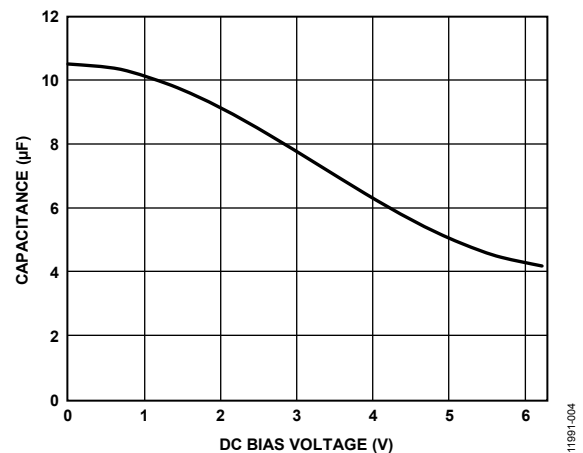

Figure 34. Typical Capacitor Performance

The peak-to-peak output voltage ripple for the selected output capacitor and inductor values is calculated using the following equation:

$$V_{RIPPLE} = \frac{I_{RIPPLE}}{8 \times f_{SW} \times C_{OUT}} \approx \frac{V_{IN}}{(2\pi \times f_{SW})^2 \times L \times C_{OUT}}$$

Capacitors with lower equivalent series resistance (ESR) are preferred to guarantee low output voltage ripple, as shown in the following equation:

$$ESR_{COUT} \leq \frac{V_{RIPPLE}}{I_{RIPPLE}}$$

The effective capacitance needed for stability, which includes temperature and dc bias effects, is a minimum of 10 μ F and a maximum of 40 μ F. A list of suggested output capacitors are shown in Table 9.

The buck regulators require 10 μ F output capacitors to guarantee stability and response to rapid load variations and to transition into and out of the PWM/PSM modes. In certain applications, where one or both buck regulators power a processor, the operating state is known because it is controlled by software. In this condition, the processor can drive the MODE pin according to the operating state; consequently, it is possible to reduce the output capacitor from 10 μ F to 4.7 μ F because the regulator does not expect a large load variation when working in PSM mode (see Figure 33.).

Table 9. Suggested 10 μ F Capacitors

| Vendor | Type | Model | Case Size | Voltage Rating (V) |
|-----------|------|---------------|-----------|--------------------|
| Murata | X5R | GRM188R60J106 | 0603 | 6.3 |
| TDK | X5R | C1608JB0J106K | 0603 | 6.3 |
| Panasonic | X5R | ECJ1VB0J106M | 0603 | 6.3 |

Input Capacitor

Higher value input capacitors help to reduce the input voltage ripple and improve transient response. Maximum input capacitor current is calculated using the following equation:

$$I_{CIN} \geq I_{LOAD(MAX)} \sqrt{\frac{V_{OUTx}(V_{INx} - V_{OUTx})}{V_{INx}}}$$

To minimize supply noise, place the input capacitor as close to the VINx pin of the buck as possible. As with the output capacitor, a low ESR capacitor is recommended.

The effective capacitance needed for stability, which includes temperature and dc bias effects, is a minimum of 4.7 μ F and a maximum of 40 μ F. A list of suggested input capacitors are shown in Table 10.

Table 10. Suggested 4.7 μ F Capacitors

| Vendor | Type | Model | Case Size | Voltage Rating (V) |
|-------------|------|--------------------|-----------|--------------------|
| Murata | X5R | GRM188R60J475ME19D | 0402 | 6.3 |
| Taiyo Yuden | X5R | JMK107BJ475 | 0402 | 6.3 |
| Panasonic | X5R | ECJ-0EB0J475M | 0402 | 6.3 |

POWER DISSIPATION AND THERMAL CONSIDERATIONS

The ADP5133 is a highly efficient micropower management unit (micro PMU), and, in most cases, the power dissipated in the device is not a concern. However, if the device operates at high ambient temperatures and maximum loading conditions, the junction temperature can reach the maximum allowable operating limit (125°C).

When the temperature exceeds 150°C, the ADP5133 turns off all the regulators, allowing the device to cool down. When the die temperature falls below 130°C, the ADP5133 resumes normal operation.

This section provides guidelines to calculate the power dissipated in the device and ensure that the ADP5133 operates below the maximum allowable junction temperature.

The efficiency for each regulator on the ADP5133 is given by

$$\eta = \frac{P_{OUT}}{P_{IN}} \times 100\% \quad (1)$$

where:

η is the efficiency.

P_{OUT} is the output power.

P_{IN} is the input power.

Power loss is given by

$$P_{LOSS} = P_{IN} - P_{OUT} \quad (2a)$$

or

$$P_{LOSS} = P_{OUT} (1 - \eta) / \eta \quad (2b)$$

Power dissipation can be calculated in several ways. The most intuitive and practical is to measure the power dissipated at the input and all the outputs. Perform the measurements at the worst-case conditions (voltages, currents, and temperature). The difference between input and output power is dissipated in the device and the inductor. Use Equation 4 to derive the power lost in the inductor and, from this, use Equation 3 to calculate the power dissipation in the ADP5133 buck converter.

A second method to estimate the power dissipation uses the efficiency curves provided for the buck regulator. When the buck efficiency is known, use Equation 2b to derive the total power lost in the buck regulator and inductor, use Equation 4 to derive the power lost in the inductor, and then calculate the power dissipation in the buck converter using Equation 3. Add the power dissipated in both bucks to find the total dissipated power.

Note that the buck efficiency curves are typical values and may not be provided for all possible combinations of V_{IN} , V_{OUT} , and I_{LOAD} . To account for these variations, it is necessary to include a safety margin when calculating the power dissipated in the buck.

A third way to estimate the power dissipation is analytical and involves modeling the losses in the buck circuit provided by Equation 8 to Equation 11.

BUCK REGULATOR POWER DISSIPATION

The power loss of the buck regulator is approximated by

$$P_{LOSS} = P_{DBUCK} + P_L \quad (3)$$

where:

P_{DBUCK} is the power dissipation on one of the ADP5133 buck regulators.

P_L is the inductor power losses.

The inductor losses are external to the device, and they do not have any effect on the die temperature.

The inductor losses are estimated (without core losses) by

$$P_L \approx I_{OUT1(RMS)}^2 \times DCR_L \quad (4)$$

where:

DCR_L is the inductor series resistance.

$I_{OUT1(RMS)}$ is the rms load current of the buck regulator.

$$I_{OUT1(RMS)} = I_{OUT1} \times \sqrt{1 + \frac{r}{12}} \quad (5)$$

where r is the normalized inductor ripple current

$$r = V_{OUT1} \times (1 - D) / (I_{OUT1} \times L \times f_{SW}) \quad (6)$$

where:

L is the inductance.

f_{SW} is the switching frequency.

D is the duty cycle.

$$D = V_{OUT1} / V_{IN1} \quad (7)$$

The ADP5133 buck regulator power dissipation, P_{DBUCK} , includes the power switch conductive losses, the switch losses, and the transition losses of each channel. There are other sources of loss, but these are generally less significant at high output load currents, where the thermal limit of the application is. Equation 8 captures the calculation that must be made to estimate the power dissipation in the buck regulator.

$$P_{DBUCK} = P_{COND} + P_{SW} + P_{TRAN} \quad (8)$$

The power switch conductive losses are due to the output current, I_{OUT1} , flowing through the P-MOSFET and the N-MOSFET power switches that have internal resistance, RDS_{ON-P} and RDS_{ON-N} . The amount of conductive power loss is found by

$$P_{COND} = [RDS_{ON-P} \times D + RDS_{ON-N} \times (1 - D)] \times I_{OUT1(RMS)}^2 \quad (9)$$

where RDS_{ON-P} is approximately 0.2 Ω , and RDS_{ON-N} is approximately 0.16 Ω at a 25°C junction temperature and $V_{IN1} = V_{IN2} = 3.6$ V. At $V_{IN1} = V_{IN2} = 2.3$ V, these values change to 0.31 Ω and 0.21 Ω , respectively, and at $V_{IN1} = V_{IN2} = 5.5$ V, the values are 0.16 Ω and 0.14 Ω , respectively.

Switching losses are associated with the current drawn by the driver to turn on and turn off the power devices at the switching frequency. The amount of switching power loss is given by

$$P_{SW} = (C_{GATE-P} + C_{GATE-N}) \times V_{INI}^2 \times f_{SW} \quad (10)$$

where:

C_{GATE-P} is the P-MOSFET gate capacitance.

C_{GATE-N} is the N-MOSFET gate capacitance.

For the [ADP5133](#), the total of ($C_{GATE-P} + C_{GATE-N}$) is approximately 150 pF.

The transition losses occur because the P-channel power MOSFET cannot be turned on or off instantaneously, and the SW node takes some time to slew from near ground to near V_{OUT1} (and from V_{OUT1} to ground). The amount of transition loss is calculated by

$$P_{TRAN} = V_{INI} \times I_{OUT1} \times (t_{RISE} + t_{FALL}) \times f_{SW} \quad (11)$$

where t_{RISE} and t_{FALL} are the rise time and the fall time of the switching node, SW. For the [ADP5133](#), the rise and fall times of SW are in the order of 5 ns.

If the preceding equations and parameters are used for estimating the converter efficiency, take note that the equations do not describe all of the converter losses, and the parameter values given are typical numbers. The converter performance also depends on the choice of passive components and board layout; therefore, a sufficient safety margin should be included in the estimate.

Power dissipation due to the ground current is small, and it can be ignored.

The total power dissipation in the [ADP5133](#) simplifies to

$$P_D = P_{D\text{BUCK}1} + P_{D\text{BUCK}2} \quad (12)$$

JUNCTION TEMPERATURE

In cases where the board temperature T_A is known, the thermal resistance parameter, θ_{JA} , can be used to estimate the junction temperature rise. T_J is calculated from T_A and P_D using the formula

$$T_J = T_A + (P_D \times \theta_{JA}) \quad (13)$$

The typical θ_{JA} value for the 16-ball, 0.5 mm pitch WLCSP is 57°C/W (see Table 6). A very important factor to consider is that θ_{JA} is based on a 4-layer 4 in × 3 in, 2.5 oz copper, as per JEDEC standard, and real applications may use different sizes and layers. It is important to maximize the copper used to remove the heat from the device. Copper exposed to air dissipates heat better than copper used in the inner layers.

If the case temperature can be measured, the junction temperature is calculated by

$$T_J = T_C + (P_D \times \Psi_{JB}) \quad (14)$$

where T_C is the case temperature and Ψ_{JB} is the junction-to-board thermal resistance provided in Table 6.

When designing an application for a particular ambient temperature range, calculate the expected [ADP5133](#) power dissipation (P_D) due to the losses of all channels by using the Equation 8 to Equation 13. From this power calculation, the junction temperature, T_J , can be estimated using Equation 14.

The reliable operation of the converter can be achieved only if the estimated die junction temperature of the [ADP5133](#) (Equation 14) is less than 125°C. Reliability and mean time between failures (MTBF) is highly affected by increasing the junction temperature. Additional information about product reliability can be found in the [ADI Reliability Handbook](#), which can be found at www.analog.com/reliability_handbook

PCB LAYOUT GUIDELINES

Poor layout can affect [ADP5133](#) performance, causing electromagnetic interference (EMI) and electromagnetic compatibility (EMC) problems, ground bounce, and voltage losses. Poor layout can also affect regulation and stability. A good layout is implemented using the following guidelines:

- Place the inductor, input capacitor, and output capacitor close to the IC using short tracks. These components carry high switching frequencies, and large tracks act as antennas.
- Route the output voltage path away from the inductor and SW node to minimize noise and magnetic interference.
- Maximize the size of ground metal on the component side to help with thermal dissipation.
- Use a ground plane with several vias connecting to the component side ground to further reduce noise interference on sensitive circuit nodes.
- Connect VIN1 and VIN2 together close to the IC using short tracks.

TYPICAL APPLICATION SCHEMATICS

Figure 35 and Figure 36 show how the mode of operation of the ADP5133 can be controlled by a processor. The MODE pin can be driven by one of the GPIO pins of the processor.

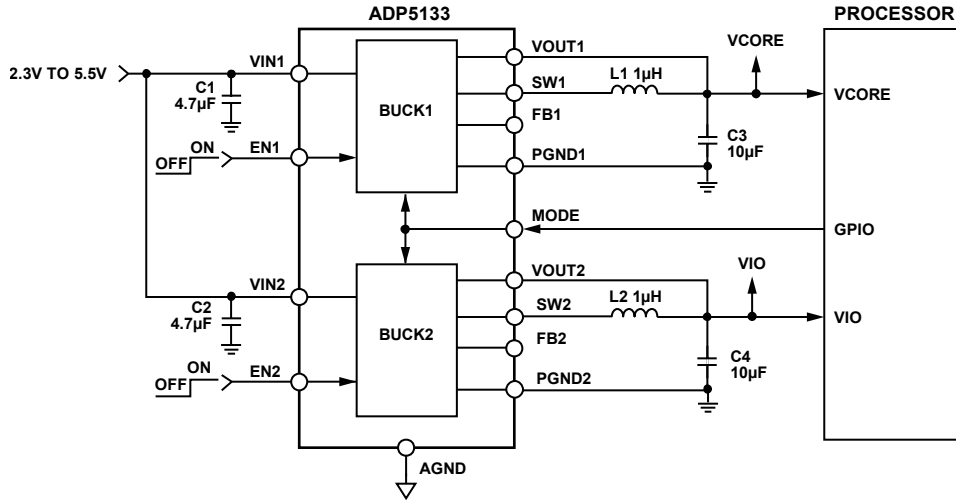

Figure 35. Typical Application, ADP5133 Fixed Output Voltages

11991-340

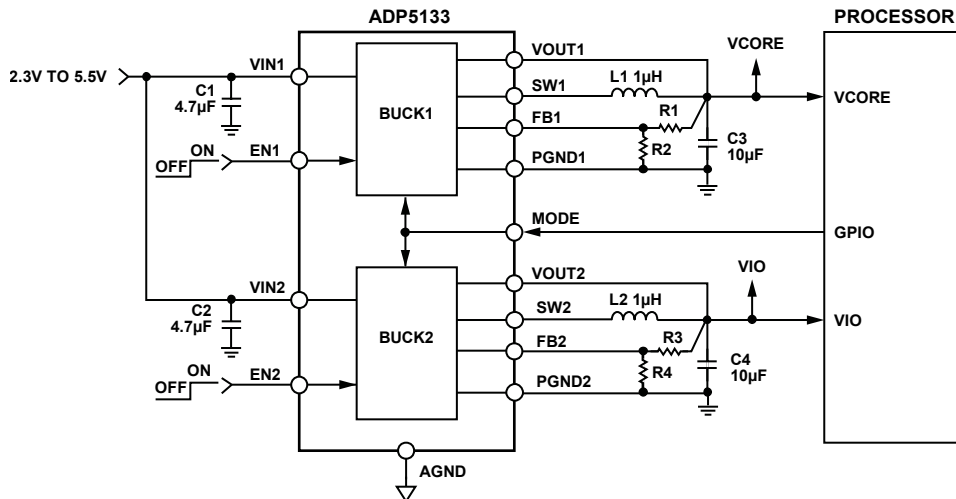

Figure 36. Typical Application, ADP5133 Adjustable Output Voltages

11991-350

OUTLINE DIMENSIONS

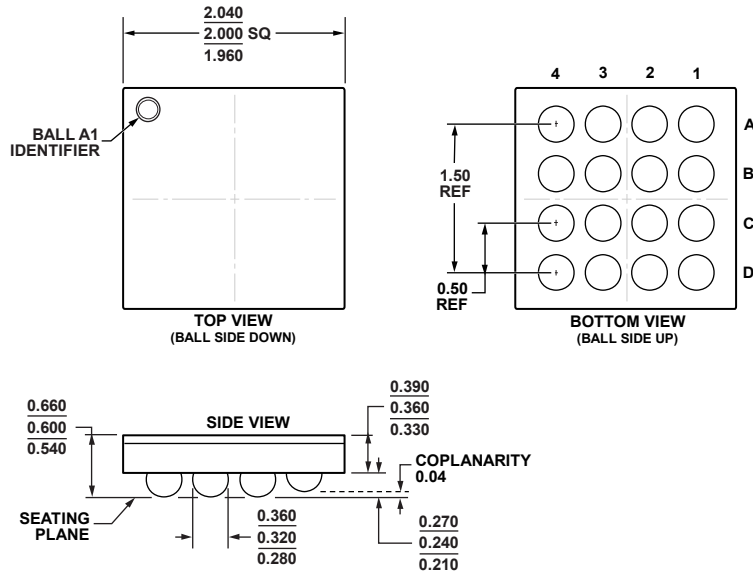

Figure 37. 16-Ball Wafer Level Chip Scale Package [WLCSP]
 Back-Coating Included
 (CB-16-8)
 Dimensions shown in millimeters

10-19-2012-B

ORDERING GUIDE

| Model ¹ | Temperature Range | Output Voltage ² (V) | UVLO ³ | Active Pull-Down ⁴ | PackageDescription | PackageOption |
|--------------------|-------------------|---------------------------------|-------------------|-------------------------------|--------------------|---------------|
| ADP5133ACBZ-R7 | -40°C to +125°C | Adjustable | LOW | Enabled on all channels | 16-Ball WLCSP | CB-16-8 |
| ADP5133CB-EVALZ | | | | | Evaluation board | |

¹ Z = RoHS Compliant Part.

² For additional options, contact a local sales or distribution representative. Additional options available include the following:
 BUCK1 and BUCK2: 3.3 V, 3.0 V, 2.8 V, 2.5 V, 2.3 V, 2.0 V, 1.8 V, 1.6 V, 1.5 V, 1.4 V, 1.3 V, 1.2 V, 1.1 V, 1.0 V, 0.9 V, or adjustable.

³ UVLO : LOW or HIGH.

⁴ BUCK1 and BUCK2: Active pull-down resistor is programmable to be either enabled or disabled.

NOTES

NOTES

NOTES

X-ON Electronics

Largest Supplier of Electrical and Electronic Components

Click to view similar products for [Switching Voltage Regulators](#) category:

Click to view products by [Analog Devices](#) manufacturer:

Other Similar products are found below :

[FAN53610AUC33X](#) [FAN53611AUC123X](#) [FAN48610BUC33X](#) [FAN48610BUC45X](#) [FAN48617UC50X](#) [R3](#) [430464BB](#) [KE177614](#)
[FAN53611AUC12X](#) [MAX809TTR](#) [NCV891234MW50R2G](#) [NCP81103MNTXG](#) [NCP81203PMNTXG](#) [NCP81208MNTXG](#)
[NCP81109GMNTXG](#) [SCY1751FCCT1G](#) [NCP81109JMNTXG](#) [AP3409ADNTR-G1](#) [NCP81241MNTXG](#) [LTM8064IY](#) [LT8315EFE#TRPBF](#)
[LTM4664EY#PBF](#) [LTM4668AIY#PBF](#) [NCV1077CSTBT3G](#) [XCL207A123CR-G](#) [MPM54304GMN-0002](#) [MPM54304GMN-0004](#)
[MPM54304GMN-0003](#) [AP62300Z6-7](#) [MP8757GL-P](#) [MIC23356YFT-TR](#) [LD8116CGL](#) [HG2269M/TR](#) [OB2269](#) [XD3526](#) [U6215A](#) [U6215B](#)
[U6620S](#) [LTC3412IFE](#) [LT1425IS](#) [MAX25203BATJA/VY+](#) [MAX77874CEWM+](#) [XC9236D08CER-G](#) [MP3416GJ-P](#) [BD9S201NUX-CE2](#)
[MP5461GC-Z](#) [MPQ4415AGQB-Z](#) [MPQ4590GS-Z](#) [MAX38640BENT18+T](#) [MAX77511AEWB+](#)