



### FEATURES

**Output P1dB:** 31 dBm typical at 20 GHz to 34 GHz

**P<sub>SAT</sub>:** 32 dBm typical at 20 GHz to 34 GHz

**Gain:** 17 dB typical at 20 GHz to 34 GHz

**Output IP3:** 41 dBm typical at 20 GHz to 34 GHz

**Supply voltage:** 5 V at 1200 mA maximum

**50 Ω matched input/output**

**Die size:** 3.75 mm × 3.47 mm × 0.1 mm

### APPLICATIONS

Military and space

Test instrumentation

### FUNCTIONAL BLOCK DIAGRAM

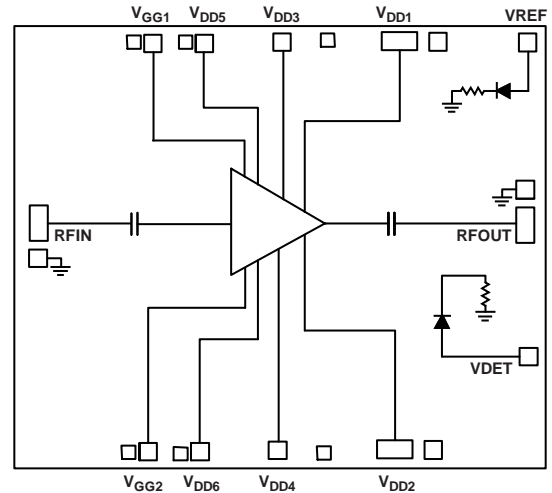

Figure 1.

### GENERAL DESCRIPTION

The ADPA7005CHIP is a gallium arsenide (GaAs), pseudomorphic high electron mobility transistor (pHEMT), monolithic microwave integrated circuit (MMIC), distributed power amplifier that operates from 20 GHz to 44 GHz. The amplifier provides 17 dB of small signal gain, 31 dBm output power for 1 dB compression (P1dB), and a typical output third-

order intercept (IP3) of 41 dBm. The ADPA7005CHIP requires 1200 mA from a 5 V supply on the supply voltage (V<sub>DD</sub>) and features inputs and outputs that are internally matched to 50 Ω, facilitating integration into multichip modules (MCMs). All data is taken with the chip connected via two 0.025 mm wire bonds that are at least 0.31 mm long.

## TABLE OF CONTENTS

Features .....	1	Applications Information .....	15
Applications .....	1	Mounting and Bonding Techniques for Millimeterwave GaAs MMICs .....	15
Functional Block Diagram .....	1	Biasing ADPA7005CHIP with the HMC980LP4E .....	17
General Description .....	1	Application Circuit Setup .....	17
Revision History .....	2	Limiting $V_{GATE}$ for ADPA7005CHIP VGGx AMR (Absolute Maximum Rating) Requirement .....	17
Specifications .....	3	HMC980LP4E Bias Sequence .....	19
20 GHz to 34 GHz Frequency Range .....	3	Constant Drain Current Biasing vs. Constant Gate Voltage Biasing .....	19
34 GHz to 44 GHz Frequency Range .....	3	Typical Application Circuit .....	21
Absolute Maximum Ratings .....	4	Assembly Diagram .....	22
ESD Caution .....	4	Outline Dimensions .....	23
Pin Configuration and Function Descriptions .....	5	Ordering Guide .....	23
Interface Schematics .....	6		
Typical Performance Characteristic .....	7		
Constant $I_{DD}$ Operation .....	13		
Theory of Operation .....	14		

## REVISION HISTORY

2/2019—Revision 0: Initial Version

**SPECIFICATIONS****20 GHz TO 34 GHz FREQUENCY RANGE**

$T_A = 25^\circ\text{C}$ ,  $V_{DD} = 5\text{ V}$ , and quiescent supply current ( $I_{DQ}$ ) = 1200 mA for nominal operation, unless otherwise noted.

**Table 1.**

Parameter	Symbol	Min	Typ	Max	Unit	Test Conditions/Comments
FREQUENCY RANGE		20		34	GHz	
GAIN		15	17		dB	
Gain Flatness			$\pm 0.5$		dB	
Gain Variation Over Temperature			0.012		dB/ $^\circ\text{C}$	
NOISE FIGURE			7		dB	
RETURN LOSS						
Input			18		dB	
Output			20		dB	
OUTPUT						
Output Power for 1 dB Compression	P1dB	28	31		dBm	Measurement taken at output power ( $P_{OUT}$ ) per tone = 14 dBm
Saturated Output Power	$P_{SAT}$		32		dBm	
Output Third-Order Intercept	IP3		41		dBm	
SUPPLY						
Current	$I_{DQ}$		1200		mA	Adjust the gate bias voltage ( $V_{GG1}$ ) between $-1.5\text{ V}$ up to $0\text{ V}$ to achieve the desired $I_{DQ}$
Voltage	$V_{DD}$	4	5		V	

**34 GHz TO 44 GHz FREQUENCY RANGE**

$T_A = 25^\circ\text{C}$ ,  $V_{DD} = 5\text{ V}$ , and  $I_{DQ} = 1200\text{ mA}$  for nominal operation, unless otherwise noted.

**Table 2.**

Parameter	Symbol	Min	Typ	Max	Unit	Test Conditions/Comments
FREQUENCY RANGE		34		44	GHz	
GAIN		11.5	14.5		dB	
Gain Flatness			$\pm 0.7$		dB	
Gain Variation Over Temperature			0.024		dB/ $^\circ\text{C}$	
NOISE FIGURE			6		dB	
RETURN LOSS						
Input			15		dB	
Output			17		dB	
OUTPUT						
Output Power for 1 dB Compression	P1dB	27	30		dBm	Measurement taken at $P_{OUT}$ per tone = 14 dBm
Saturated Output Power	$P_{SAT}$		31		dBm	
Output Third-Order Intercept	IP3		40.5		dBm	
SUPPLY						
Current	$I_{DQ}$		1200		mA	Adjust $V_{GG1}$ between $-1.5\text{ V}$ up to $0\text{ V}$ to achieve the desired $I_{DQ}$
Voltage	$V_{DD}$	4	5		V	

## ABSOLUTE MAXIMUM RATINGS

Table 3.

Parameter	Rating
Drain Bias Voltage ( $V_{DDX}$ )	6.0 V
$V_{GG1}$	-1.5 to 0 V
Radio Frequency Input Power (RFIN)	27 dBm
Continuous Power Dissipation ( $P_{DISS}$ ), T = 85°C (Derate 149.2 mW/°C Above 85°C)	13.4 W
Storage Temperature Range	-65°C to +150°C
Operating Temperature Range	-55°C to +85°C
Electrostatic Discharge (ESD) Sensitivity Human Body Model (HBM)	Class 1B (passed 500 V)

Stresses at or above those listed under Absolute Maximum Ratings may cause permanent damage to the product. This is a stress rating only; functional operation of the product at these or any other conditions above those indicated in the operational section of this specification is not implied. Operation beyond the maximum operating conditions for extended periods may affect product reliability.

## THERMAL RESISTANCE

Thermal performance is directly linked to system design and operating environment. Careful attention to the printed circuit board (PCB) thermal design is required.  $\theta_{JC}$  is the channel to case thermal resistance, channel to bottom of die using die attach epoxy.

Table 4. Thermal Resistance

Package Type	$\theta_{JC}$	Unit
C-12-3	6.7	°C/W

Table 5. Reliability Information

Parameter	Temperature (°C)
Junction Temperature to Maintain 1,000,000 Hour Mean Time to Failure (MTTF)	175
Nominal Junction Temperature (T = 85°C, $V_{DD} = 5$ V, $I_{DQ} = 600$ mA)	125.2

## ESD CAUTION



**ESD (electrostatic discharge) sensitive device.** Charged devices and circuit boards can discharge without detection. Although this product features patented or proprietary protection circuitry, damage may occur on devices subjected to high energy ESD. Therefore, proper ESD precautions should be taken to avoid performance degradation or loss of functionality.

## PIN CONFIGURATION AND FUNCTION DESCRIPTIONS

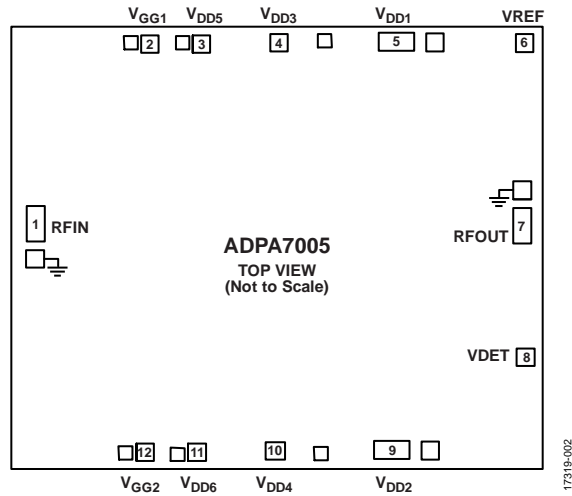

Figure 2. Pin Configuration

Table 6. Pin Function Descriptions

Pin No.	Mnemonic	Description
1	RFIN	RF Signal Input. This pad is ac-coupled and matched to 50 Ω.
2, 12	V <sub>GG1</sub> , V <sub>GG2</sub>	Amplifier Gate Control. External bypass capacitors of 4.7 μF, 0.01 μF, and 100 pF are required. ESD protection diodes are included and turn on below –1.5 V.
3, 4, 5, 9, 10, 11	V <sub>DD5</sub> , V <sub>DD3</sub> , V <sub>DD1</sub> , V <sub>DD2</sub> , V <sub>DD4</sub> , V <sub>DD6</sub>	Drain Bias for the amplifier. External bypass capacitors of 4.7 μF, 0.01 μF, and 100 pF are required.
6	VREF	Reference Diode. Use this pin in combination with VDET. The voltage provides temperature compensation to the VDET RF output power measurements.
7	RFOUT	RF Signal Output. This pad is ac-coupled and matched to 50 Ω.
8	VDET	Detector Diode Used for Measuring the RF Output Power. Detection via this pin requires the application of a dc bias voltage through an external series resistor. Used in combination with VREF, the difference voltage, VREF – VDET, is a temperature compensated dc voltage proportional to the RF output power.
Die Bottom	GND	Ground. The pads and die bottom must be connected to RF and dc ground.

INTERFACE SCHEMATICS



Figure 3. GND Interface Schematic

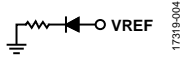

Figure 4. VREF Interface Schematic

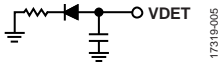

Figure 5. VDET Interface Schematic

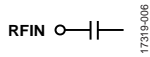

Figure 6. RFIN Interface Schematic

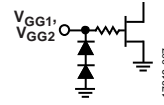

Figure 7. VGG1, VGG2 Interface Schematic

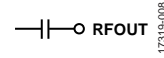

Figure 8. RFOUT Interface Schematic

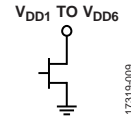

Figure 9. VDD1 to VDD6 Interface Schematic

### TYPICAL PERFORMANCE CHARACTERISTIC

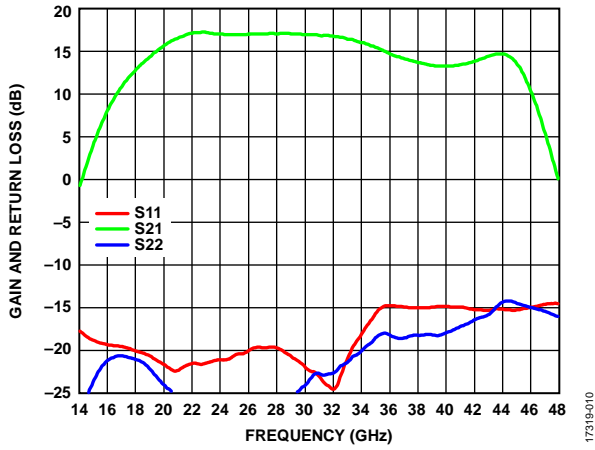

Figure 10. Gain and Return Loss vs. Frequency,  $V_{DD} = 5\text{ V}$ ,  $I_{DQ} = 1200\text{ mA}$

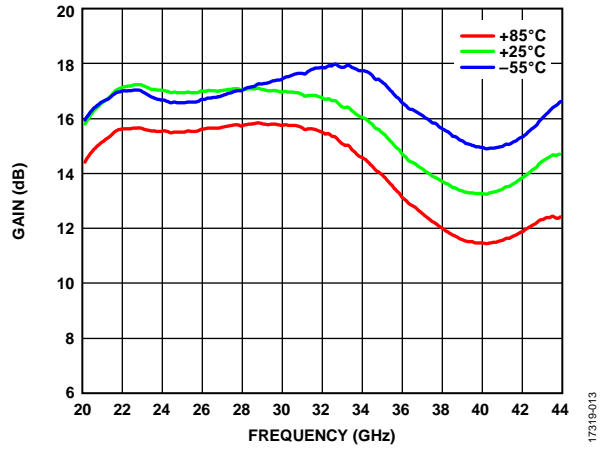

Figure 13. Gain vs. Frequency for Various Temperatures,  $V_{DD} = 5\text{ V}$ ,  $I_{DQ} = 1200\text{ mA}$

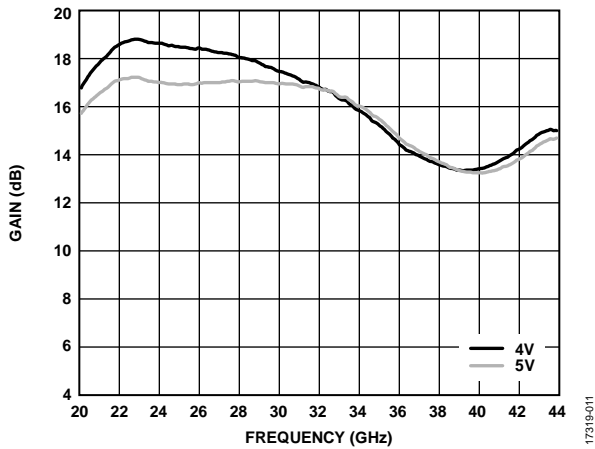

Figure 11. Gain vs. Frequency for Various  $V_{DD}$ ,  $I_{DQ} = 1200\text{ mA}$

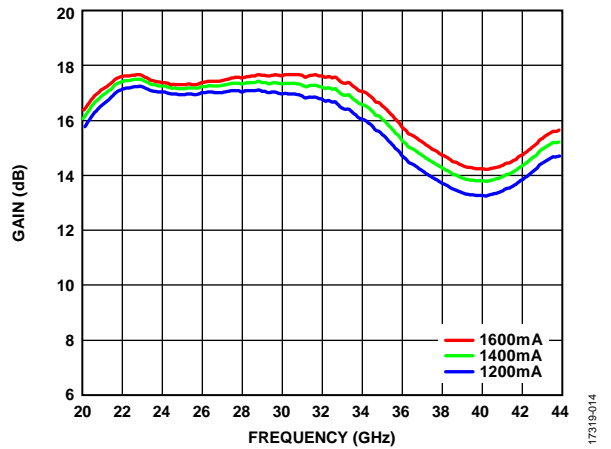

Figure 14. Gain vs. Frequency for Various  $I_{DQ}$ ,  $V_{DD} = 5\text{ V}$

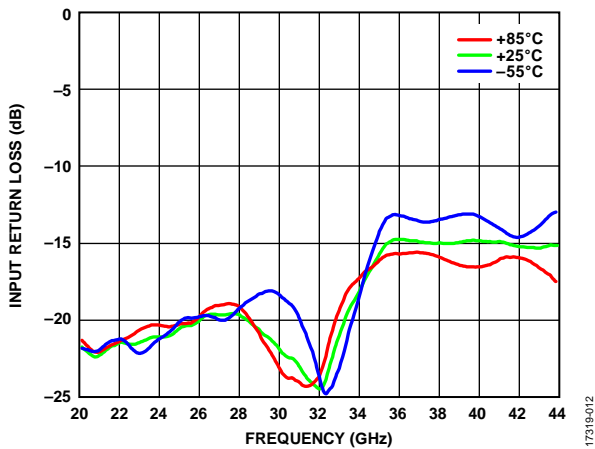

Figure 12. Input Return Loss vs. Frequency for Various Temperatures,  $V_{DD} = 5\text{ V}$ ,  $I_{DQ} = 1200\text{ mA}$

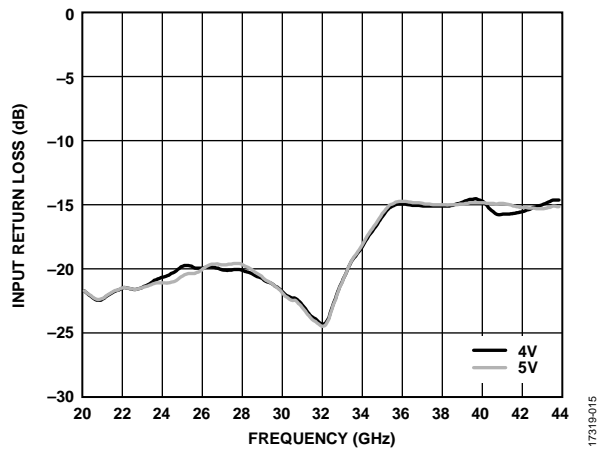

Figure 15. Input Return Loss vs. Frequency for Various  $V_{DD}$ ,  $I_{DQ} = 1200\text{ mA}$

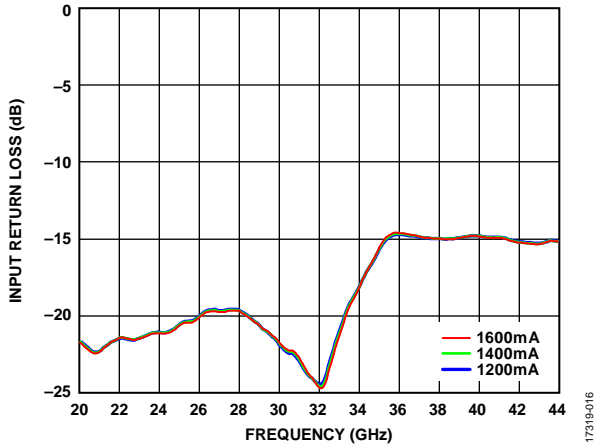

Figure 16. Input Return Loss vs. Frequency for Various  $I_{DQ}$ ,  $V_{DD} = 5 V$

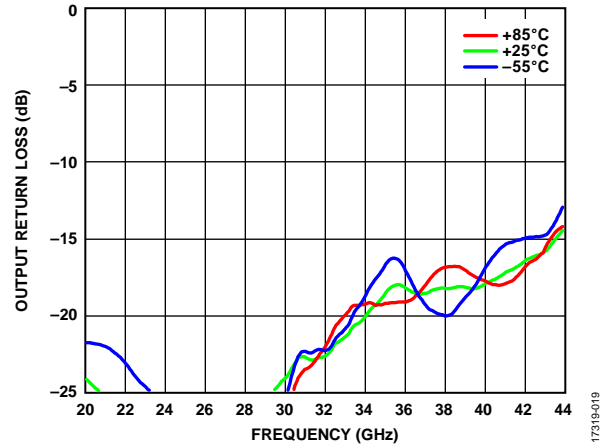

Figure 19. Output Return Loss vs. Frequency for Various Temperature,  $V_{DD} = 5 V$ ,  $I_{DQ} = 1200 mA$

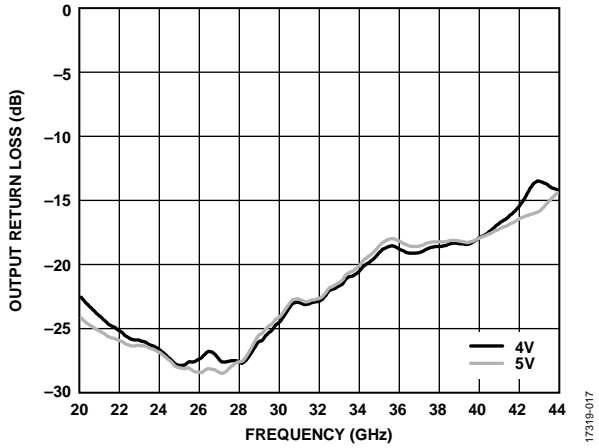

Figure 17. Output Return Loss vs Frequency for Various  $V_{DD}$ ,  $I_{DQ} = 1200 mA$

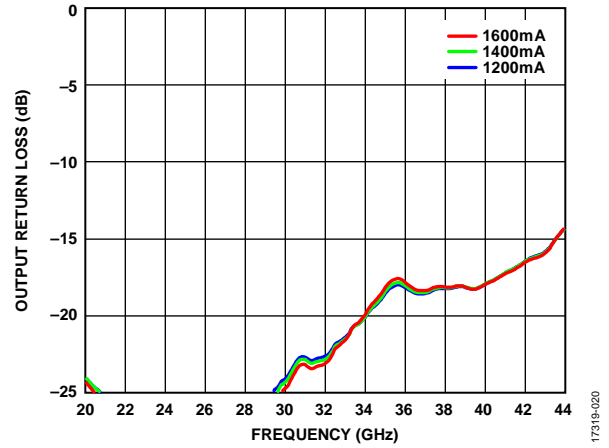

Figure 20. Output Return Loss vs. Frequency for Various  $I_{DQ}$ ,  $V_{DD} = 5 V$

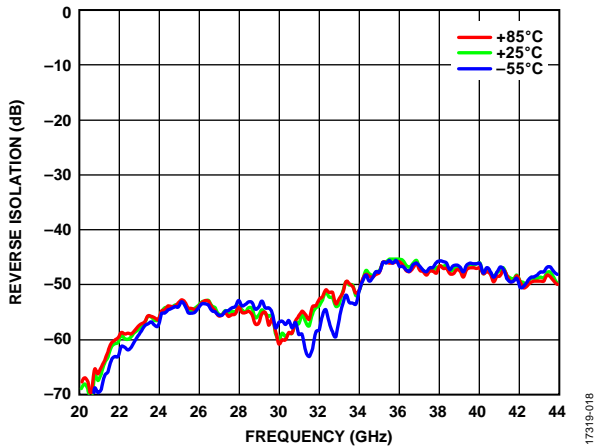

Figure 18. Reverse Isolation vs. Frequency for Various Temperatures,  $V_{DD} = 5 V$ ,  $I_{DQ} = 1200 mA$

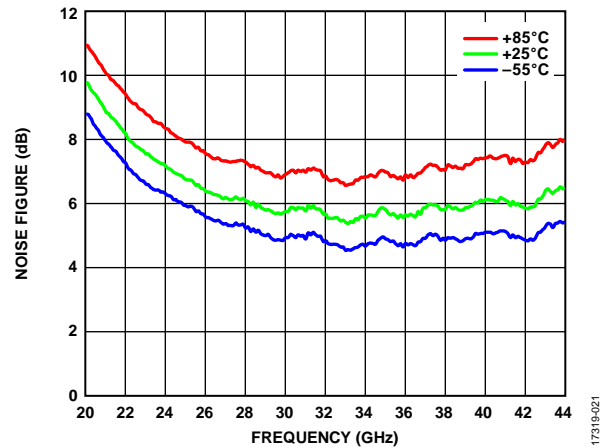

Figure 21. Noise Figure vs. Frequency for Various Temperatures,  $V_{DD} = 5 V$ ,  $I_{DQ} = 1200 mA$



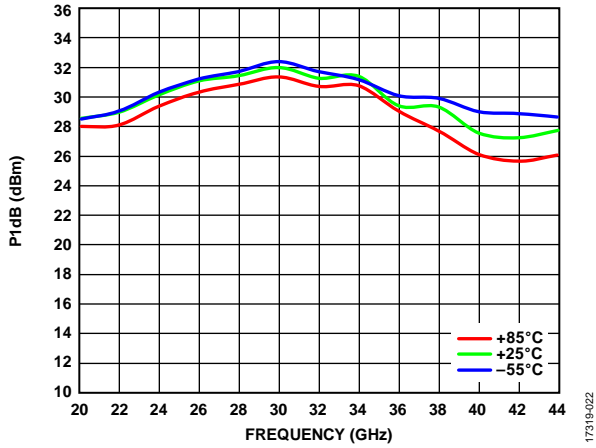

Figure 22. Output P1dB vs. Frequency for Various Temperatures,  $V_{DD} = 5V$ ,  $I_{DQ} = 1200mA$

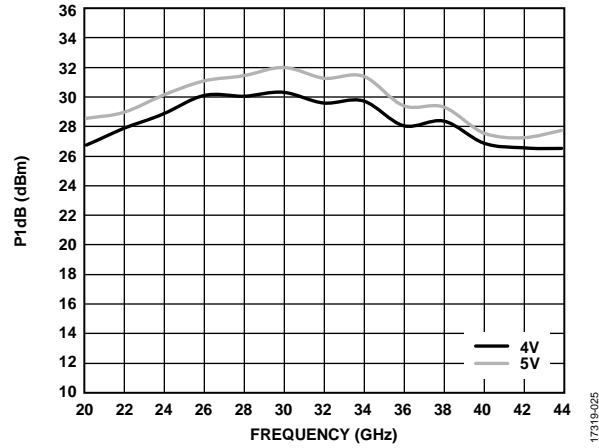

Figure 25. P1dB vs. Frequency for Various  $V_{DD}$ ,  $I_{DQ} = 1200mA$

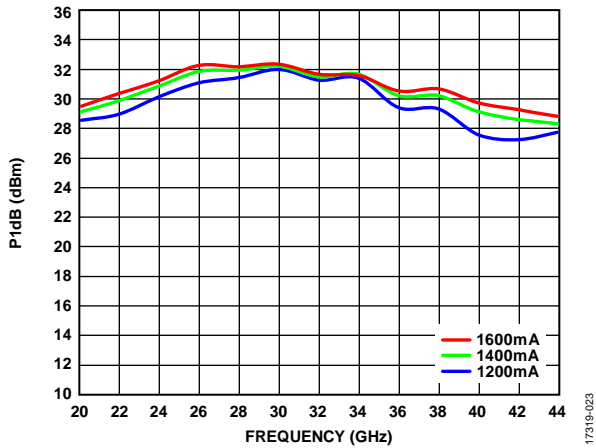

Figure 23. P1dB vs. Frequency for Various  $I_{DQ}$ ,  $V_{DD} = 5V$

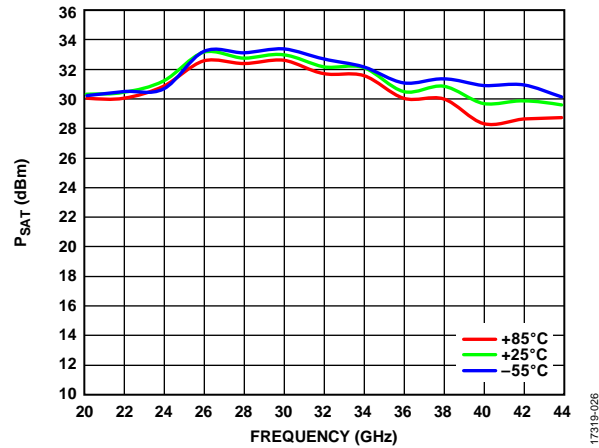

Figure 26.  $P_{SAT}$  vs. Frequency for Various Temperatures,  $V_{DD} = 5V$ ,  $I_{DQ} = 1200mA$

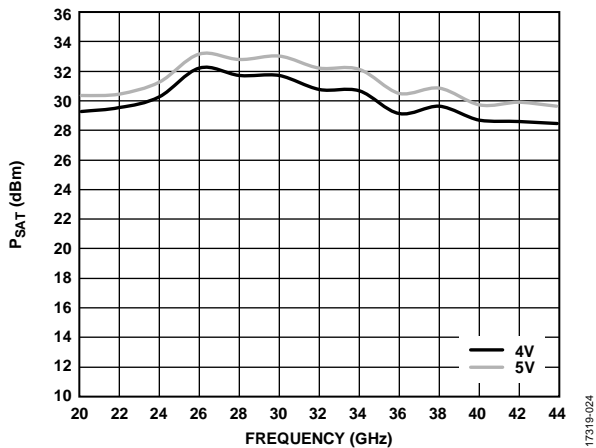

Figure 24.  $P_{SAT}$  vs. Frequency for Various  $V_{DD}$ ,  $I_{DQ} = 1200mA$

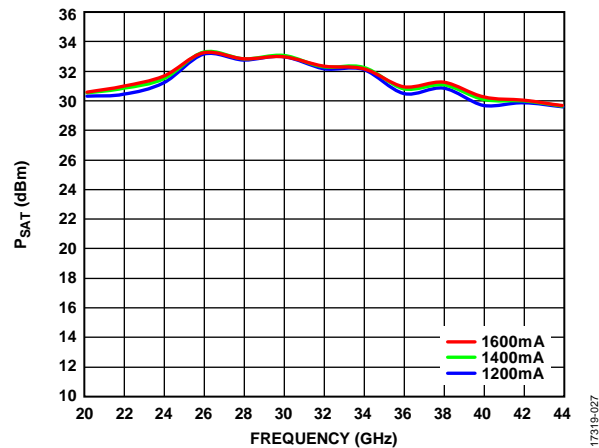

Figure 27.  $P_{SAT}$  vs. Frequency for Various  $I_{DQ}$ ,  $V_{DD} = 5V$

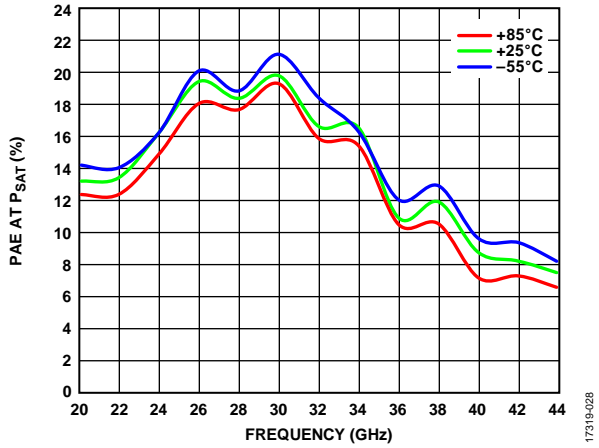

Figure 28. Power Added Efficiency (PAE) at  $P_{SAT}$  vs. Frequency for Various Temperatures,  $V_{DD} = 5\text{ V}$ ,  $I_{DQ} = 1200\text{ mA}$ , PAE Measured at  $P_{SAT}$

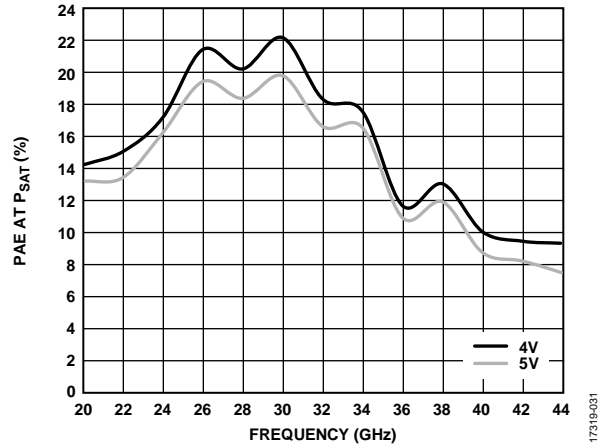

Figure 31. PAE at  $P_{SAT}$  vs. Frequency for Various  $V_{DD}$ ,  $I_{DQ} = 1200\text{ mA}$ , PAE Measured at  $P_{SAT}$

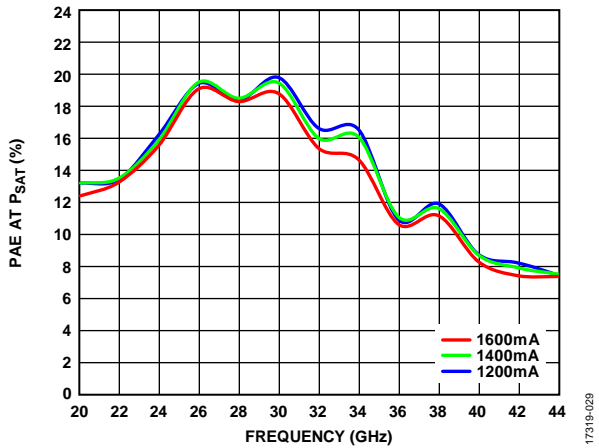

Figure 29. PAE at  $P_{SAT}$  vs. Frequency for Various  $I_{DQ}$ ,  $V_{DD} = 5\text{ V}$ ,  $I_{DQ} = 1200\text{ mA}$ , PAE Measured at  $P_{SAT}$

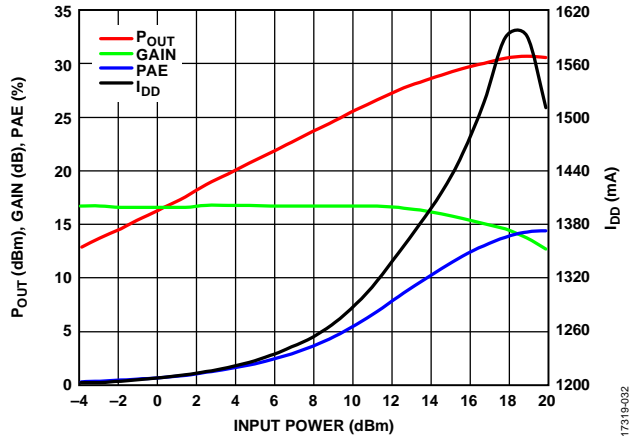

Figure 32.  $P_{OUT}$ , Gain, PAE, and  $I_{DD}$  vs. Input Power, 22 GHz,  $V_{DD} = 5\text{ V}$ ,  $I_{DD} = 1200\text{ mA}$

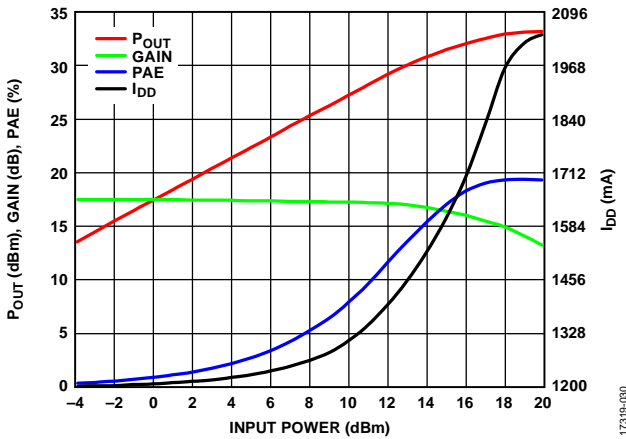

Figure 30.  $P_{OUT}$ , Gain, PAE, and Power PAE, Drain Current with RF Applied ( $I_{DD}$ ) vs. Input Power, 26 GHz,  $V_{DD} = 5\text{ V}$ ,  $I_{DD} = 1200\text{ mA}$

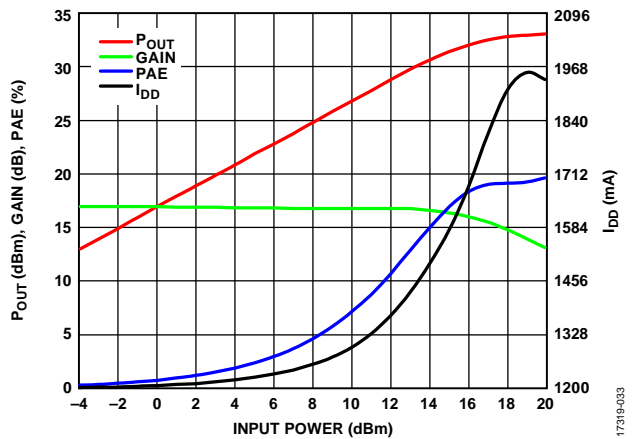

Figure 33.  $P_{OUT}$ , Gain, PAE, and  $I_{DD}$  vs. Input Power, 30 GHz,  $V_{DD} = 5\text{ V}$ ,  $I_{DD} = 1200\text{ mA}$

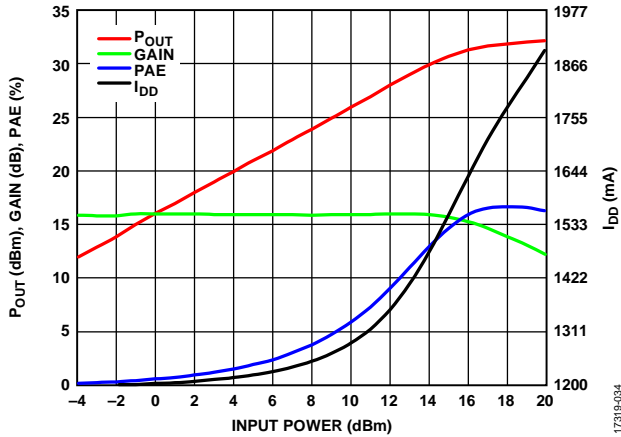

Figure 34.  $P_{OUT}$ , Gain, PAE, and  $I_{DD}$  vs. Input Power, 34 GHz,  $V_{DD} = 5\text{ V}$ ,  $I_{DD} = 1200\text{ mA}$

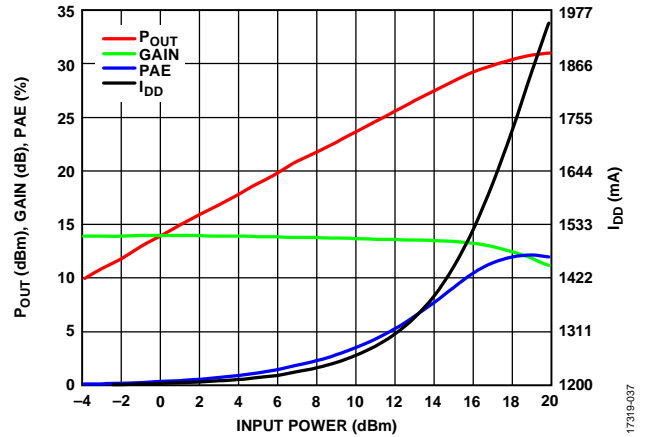

Figure 37.  $P_{OUT}$ , Gain, PAE, and  $I_{DD}$  vs. Input Power, 38 GHz,  $V_{DD} = 5\text{ V}$ ,  $I_{DD} = 1200\text{ mA}$

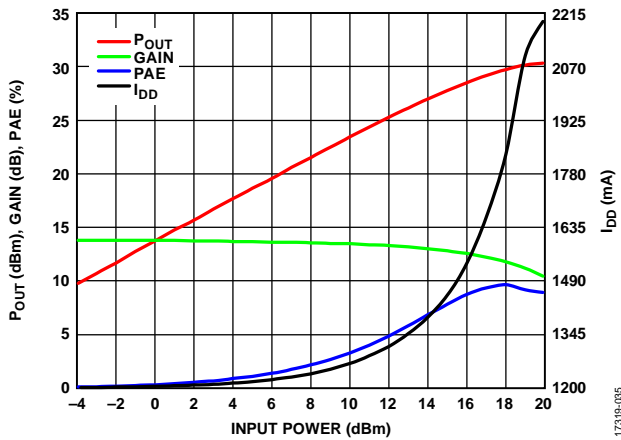

Figure 35.  $P_{OUT}$ , Gain, PAE, and  $I_{DD}$  vs. Input Power, 42 GHz,  $V_{DD} = 5\text{ V}$ ,  $I_{DD} = 1200\text{ mA}$

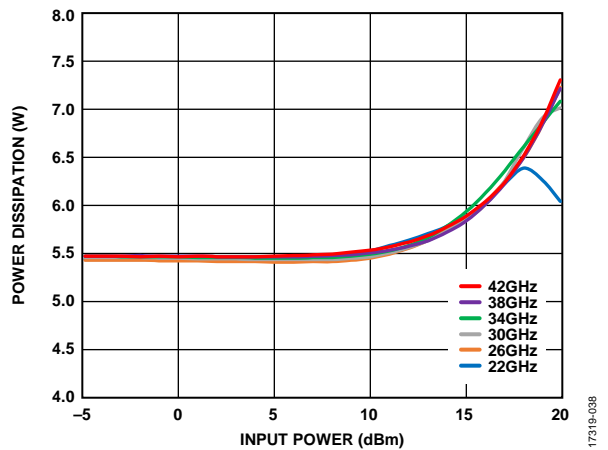

Figure 38. Power Dissipation vs. Input Power at  $T = 85^\circ\text{C}$ ,  $V_{DD} = 5\text{ V}$ ,  $I_{DD} = 1200\text{ mA}$

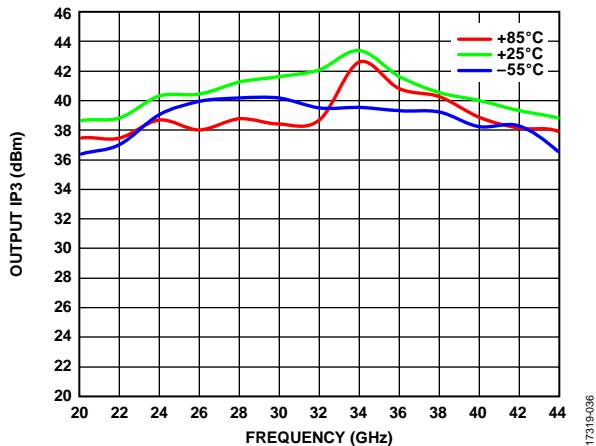

Figure 36. Output  $IP_3$  vs. Frequency for Various Temperatures,  $P_{OUT}$  per Tone = 14 dBm,  $V_{DD} = 5\text{ V}$ ,  $I_{DQ} = 1200\text{ mA}$

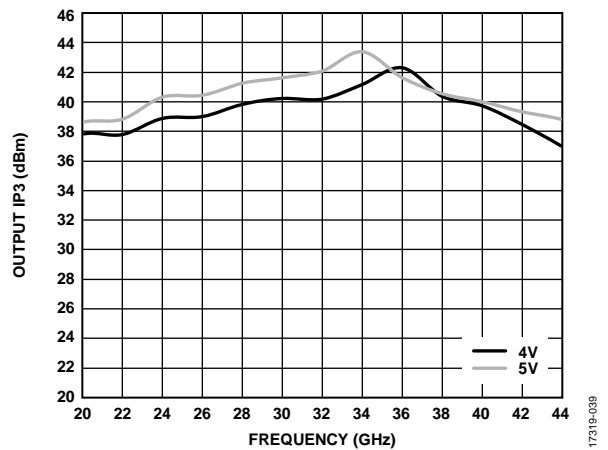

Figure 39. Output  $IP_3$  vs. Frequency for Various  $V_{DD}$ ,  $P_{OUT}$  per Tone = 14 dBm,  $V_{DD} = 5\text{ V}$ ,  $I_{DQ} = 1200\text{ mA}$

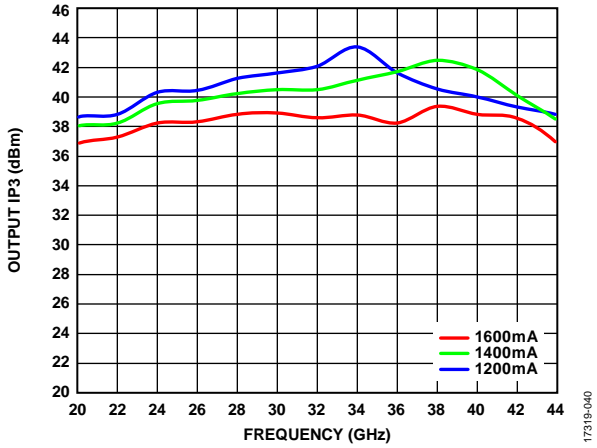

Figure 40. Output IP3 vs Frequency for Various  $I_{DQ}$ ,  $P_{OUT}$  per Tone = 14 dBm,  $V_{DD} = 5 V$

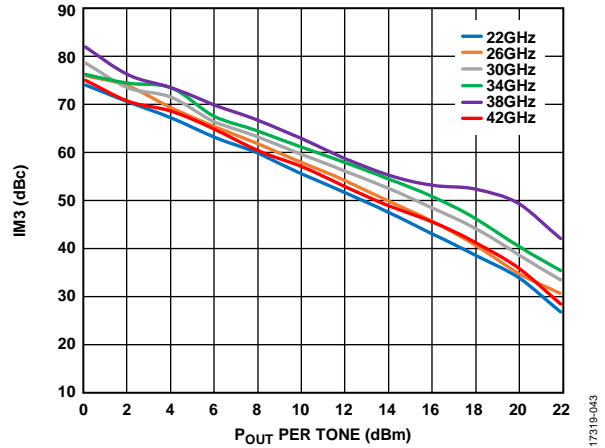

Figure 43. Third-Order Intermodulation (IM3) Distortion Relative to Carrier vs.  $P_{OUT}$  per Tone,  $V_{DD} = 4 V$ ,  $I_{DQ} = 1200 mA$

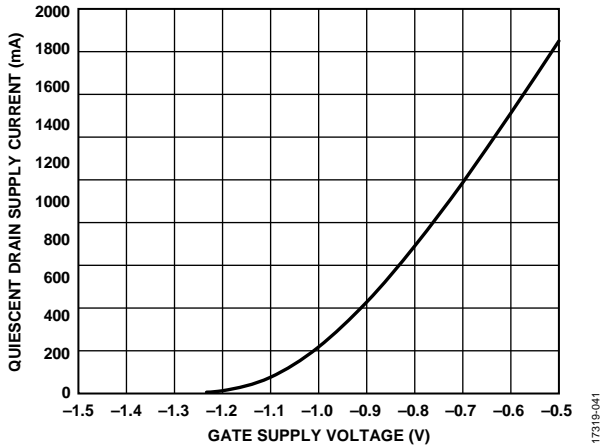

Figure 41. Quiescent Drain Supply Current vs. Gate Supply Voltage

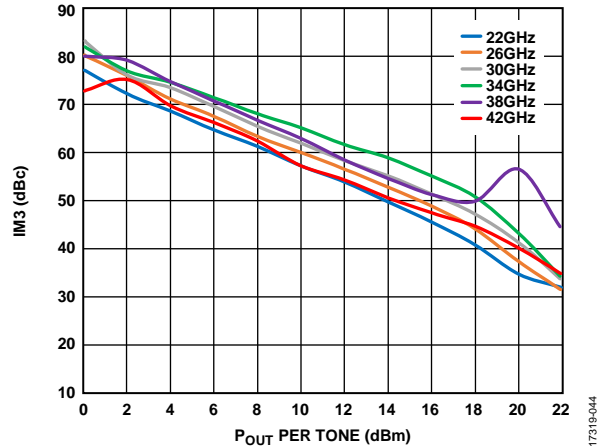

Figure 44. IM3 Distortion Relative to Carrier vs.  $P_{OUT}$  per Tone,  $V_{DD} = 5 V$ ,  $I_{DQ} = 1200 mA$

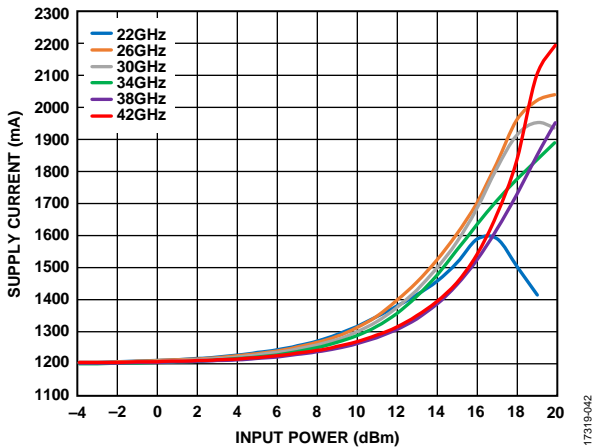

Figure 42. Supply Current  $I_{DD}$  vs. Input Power at Various Frequencies,  $V_{DD} = 5 V$ ,  $I_{DQ} = 1200 mA$

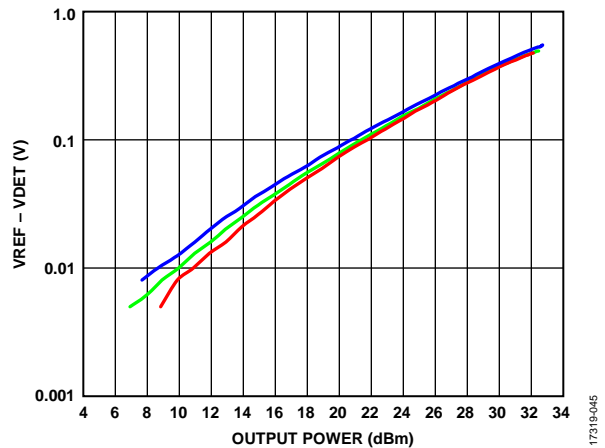

Figure 45.  $V_{REF} - V_{DET}$  vs. Output Power for Various Temperatures at 32 GHz

**CONSTANT  $I_{DD}$  OPERATION**

Biased with HMC980LP4E active bias controller (see Figure 55),  $T_A = 25^\circ\text{C}$ ,  $V_{DD} = 5\text{ V}$ , and  $I_{DD} = 1600\text{ mA}$  for nominal operation, unless otherwise noted.

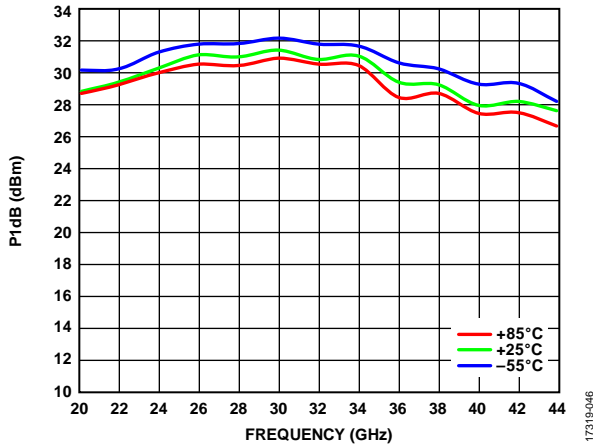

Figure 46.  $P_{1dB}$  vs. Frequency for Various Temperatures,  $V_{DD} = 5\text{ V}$ , Data Measured with Constant  $I_{DD}$

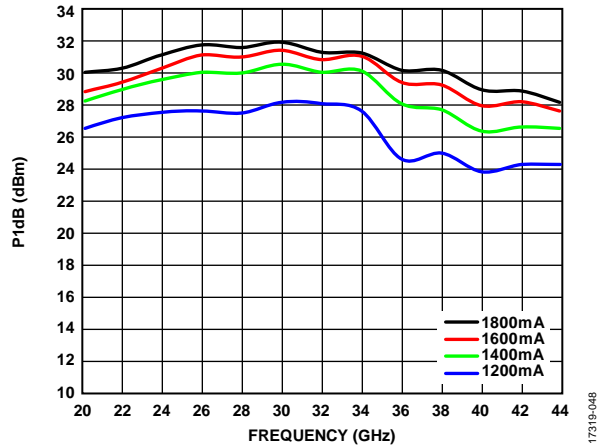

Figure 48.  $P_{1dB}$  vs. Frequency for Various Drain Currents,  $V_{DD} = 5\text{ V}$ , Data Measured with Constant  $I_{DD}$

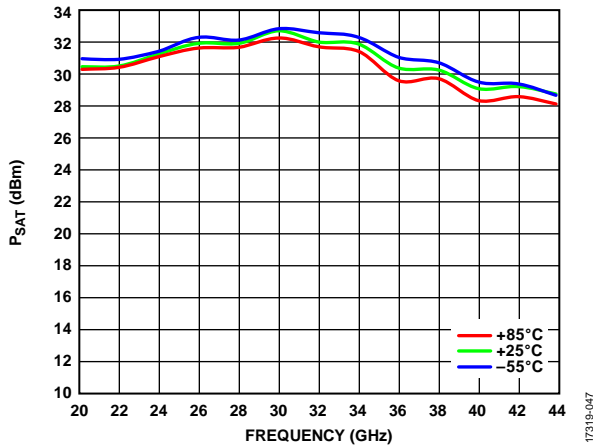

Figure 47.  $P_{SAT}$  vs. Frequency for Various Temperatures,  $V_{DD} = 5\text{ V}$ , Data Measured with Constant  $I_{DD}$

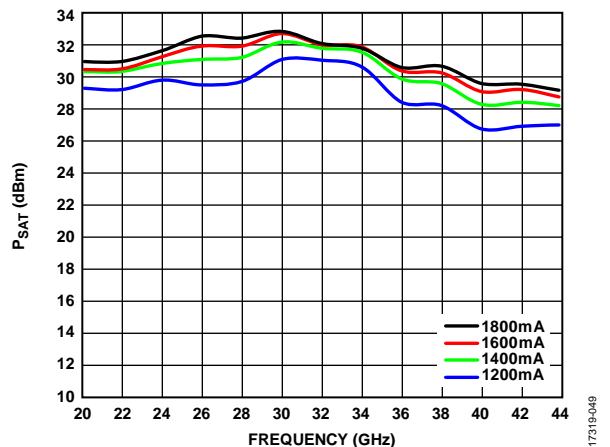

Figure 49.  $P_{SAT}$  vs. Frequency for Various Drain Currents,  $V_{DD} = 5\text{ V}$ , Data Measured with Constant  $I_{DD}$

## THEORY OF OPERATION

The architecture of the ADPA7005CHIP, a medium power amplifier, is shown in Figure 50. The ADPA7005CHIP uses two cascaded, three stage amplifiers operating in quadrature between six 90° hybrids.

The input signal is divided evenly into two, and then each signal is divided into two again. Each of these new paths are amplified through three independent gain stages. The amplified signals are then combined at the output. This balanced amplifier approach forms an amplifier with a combined gain of 15 dB and a  $P_{SAT}$  value of 32 dBm.

A portion of the RF output signal is directionally coupled to a diode for detection of the RF output power. When the diode is

dc biased, the diode rectifies the RF power and makes the RF power available for measurement as a dc voltage at VDET. To allow temperature compensation of VDET, an identical and symmetrically located circuit, minus the coupled RF power, is available via VREF. Taking the difference of VREF – VDET provides a temperature compensated signal that is proportional to the RF output (see Figure 50).

The 90° hybrids ensure that the input and output return losses are greater than 15 dB. See the application circuits shown in Figure 63 and Figure 64 for further details on biasing the various blocks.

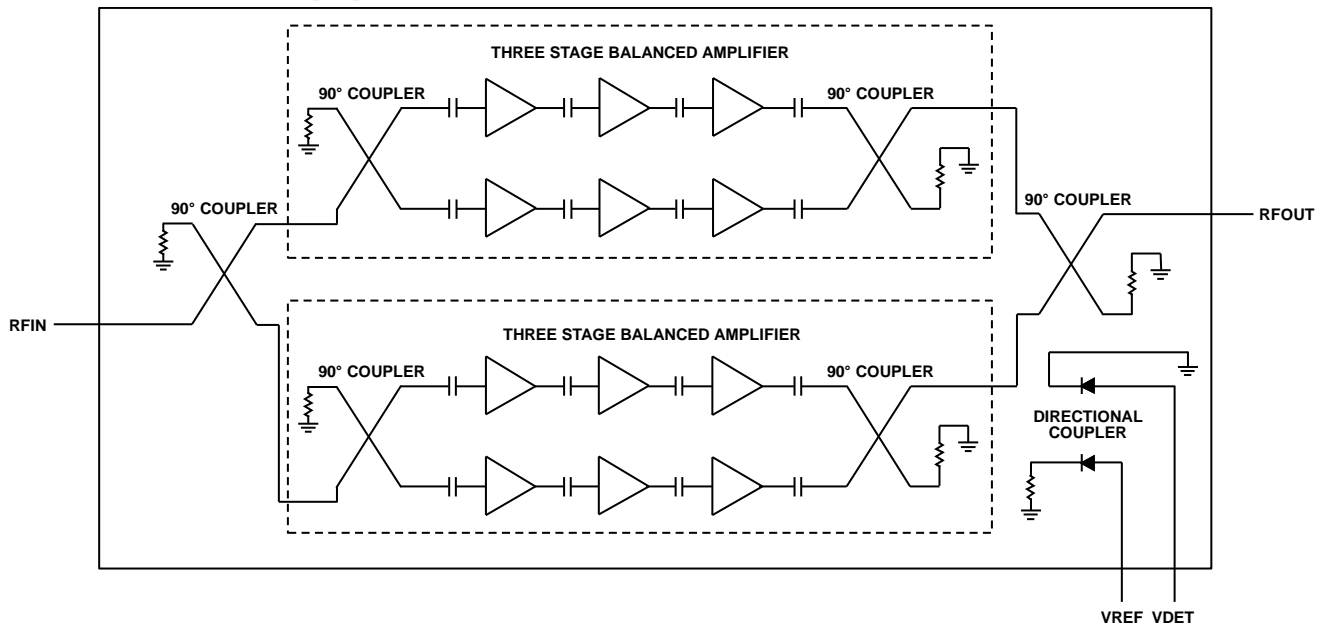

Figure 50. ADPA7005CHIP Architecture

17319-050

## APPLICATIONS INFORMATION

The ADPA7005CHIP is a GaAs, pHEMT, MMIC power amplifier. Capacitive bypassing is required for all  $V_{GGx}$  and  $V_{DDx}$  pins (see Figure 51).  $V_{GG1}$  is the gate bias pad for the top cascaded amplifiers.  $V_{GG2}$  is the gate bias pad for the bottom cascaded amplifiers.  $V_{DD1}$ ,  $V_{DD3}$ , and  $V_{DD5}$  are drain bias pads for the top cascaded amplifiers.  $V_{DD2}$ ,  $V_{DD4}$ , and  $V_{DD6}$  are drain bias pads for the bottom cascaded amplifiers.

All measurements for this device were taken using the typical application circuit (see Figure 63) and were configured as shown in the assembly diagram (Figure 64).

The following is the recommended bias sequence during power-up:

1. Connect GND to RF and dc ground.
2. Set all gate bias voltages,  $V_{GG1}$  and  $V_{GG2}$ , to  $-2$  V.
3. Set all drain bias voltages,  $V_{DDxx}$ , to  $5$  V.
4. Increase the gate bias voltage to achieve the quiescent supply current and set  $I_{DQ} = 1200$  mA.
5. Apply the RF signal.

The following is the recommended bias sequence during power-down:

1. Turn off the RF signal.
2. Decrease the gate bias voltages,  $V_{GG1}$  and  $V_{GG2}$ , to  $-2$  V to achieve an  $I_{DQ} = 0$  mA (approximately).
3. Decrease all drain bias voltages to  $0$  V.
4. Increase the  $V_{GG1}$  and  $V_{GG2}$  gate bias voltage to  $0$  V.

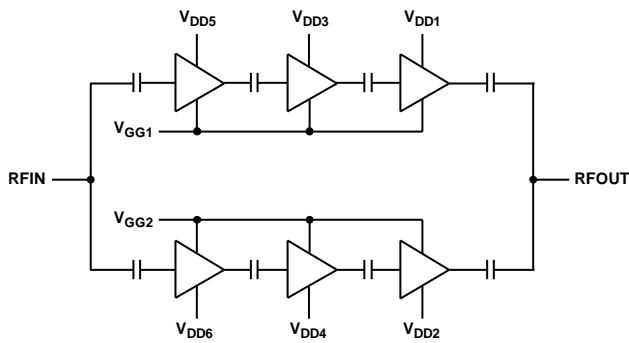

Figure 51. Simplified Block Diagram

Simplified bias pad connections to the dedicated gain stages and dependence and independence among pads are shown in Figure 51.

Table 7. Power Selection Table<sup>1,2</sup>

$I_{DQ}$ (mA)	Gain (dB)	P1dB (dBm)	OIP3 (dBm)	$P_{DISS}$ (W)	$V_{GG}$ (V)
1200	17	32.0	42	6	-0.59
1400	17.4	32.3	40.2	7	-0.53
1600	17.7	32.5	38.4	8	-0.46

<sup>1</sup> Data taken at the following nominal bias conditions:  $V_{DD} = 5$  V,  $T = 25^{\circ}\text{C}$ .

<sup>2</sup> Adjust  $V_{GG1}$  and  $V_{GG2}$  from  $-2$  V to  $0$  V to achieve the desired drain current.

The  $V_{DD} = 5$  V and  $I_{DD} = 1200$  mA bias conditions are recommended to optimize overall performance. Unless otherwise noted, the data shown was taken using the recommended bias conditions. Operation of the ADPA7005CHIP at different bias conditions may provide performance that differs from what is shown in Figure 63 and Figure 64. Biasing the ADPA7005CHIP for higher drain current typically results in higher P1dB, output IP3, and gain at the expense of increased power consumption (see Table 7).

## MOUNTING AND BONDING TECHNIQUES FOR MILLIMETERWAVE GaAs MMICs

Attach the die directly to the ground plane with conductive epoxy (see the Handling Precautions section, the Mounting section, and the Wire Bonding section).

Microstrip,  $50\ \Omega$  transmission lines on  $0.127$  mm thick alumina thin film substrates are recommended for bringing the RF to and from the chip. Raise the die  $0.075$  mm to ensure that the surface of the die is coplanar with the surface of the substrate.

Place the microstrip substrates as close to the die as possible to minimize ribbon bond length. Typical die to substrate spacing is  $0.076$  mm to  $0.152$  mm. To ensure wideband matching, a  $15$  fF capacitive stub is recommended on the PCB before the ribbon bond.

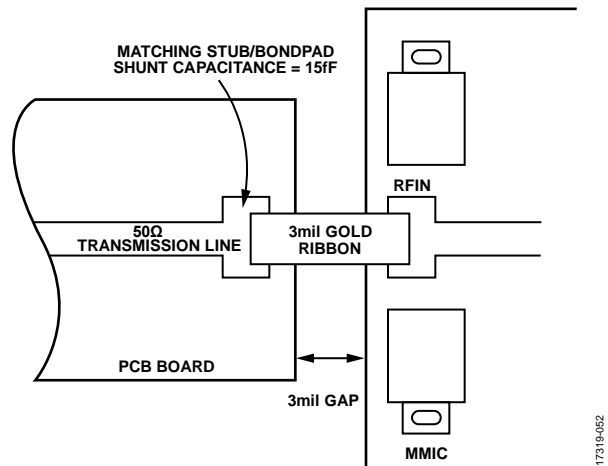

Figure 52. High Frequency Input Wideband Matching





## BIASING ADPA7005CHIP WITH THE HMC980LP4E

The **HMC980LP4E** is an active bias controller that is designed to meet the bias requirements for enhancement mode and depletion mode amplifiers such as the ADPA7005CHIP. The controller provides constant drain current biasing over temperature and part to part variation, and properly sequences gate and drain voltages to ensure the safe operation of the amplifier. The **HMC980LP4E** also offers self protection in the event of a short circuit, as well as an internal charge pump that generates the negative voltage needed on the gate of the ADPA7005CHIP, and the option to use an external negative voltage source. **HMC980LP4E** is also available in die form as the HMC980-DIE.

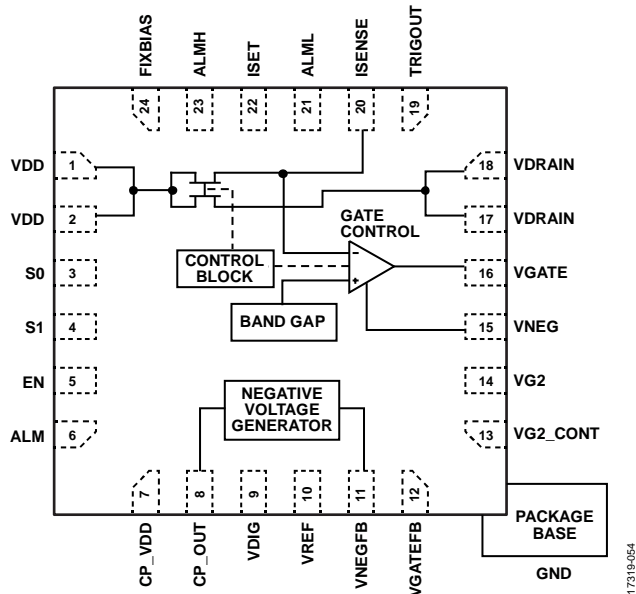

Figure 54. Functional Diagram of **HMC980LP4E**

### APPLICATION CIRCUIT SETUP

Figure 55 displays the schematic of an application circuit using the **HMC980LP4E** to control the ADPA7005CHIP. When using an external negative supply for VNEG, refer to the schematic in Figure 56.

In the application circuit shown in Figure 55, the ADPA7005CHIP drain voltage and drain current are set by the following equations:

$$V_{DRAIN} (5 V) = V_{DD} (6.12 V) - I_{DRAIN} (1600 mA) \times 0.7 \Omega \quad (1)$$

$$I_{DRAIN} (1600 mA) = 150 \Omega A \div R10 (93.1 \Omega) \quad (2)$$

where  $I_{DRAIN}$  is constant drain current.

### LIMITING $V_{GATE}$ FOR ADPA7005CHIP $V_{GGx}$ ABSOLUTE MAXIMUM RATING REQUIREMENT

When using the **HMC980LP4E** to control the ADPA7005CHIP, the minimum voltages for VNEG and VGATE must be  $-1.5 V$  to keep these voltages within the absolute maximum rating limits for the  $V_{GGx}$  pads of the ADPA7005CHIP. To set the minimum voltages, set R15 and R16 to the values shown in Figure 55 and Figure 56. Please refer to the [AN-1363](#) for more information and calculations for R15 and R16.



### HMC980LP4E BIAS SEQUENCE

The dc supply sequencing in the Power-Up Sequence section and the Power-Down Sequence section is required to prevent damage to the HMC980LP4E when using it to control the ADPA7005CHIP.

#### Power-Up Sequence

The power-up sequence is as follows:

1. VDIG = 3.3 V
2. S0 = 3.3 V
3. VDD = 5.68 V
4. VNEG = -1.5 V (unnecessary if using internally generated voltage)
5. EN = 3.3 V (transition from 0 V to 3.3 V turns on VGATE and VDRAIN)

#### Power-Down Sequence

The power-down sequence is as follows:

1. EN = 0 V (transition from 3.3 V to 0 V turns off VDRAIN and VGATE)
2. VNEG = 0 V (unnecessary if using internally generated voltage)
3. VDD = 0 V
4. S0 = 0 V
5. VDIG = 0 V

After the HMC980LP4E bias control circuit is set up, toggle the bias to the ADPA7005CHIP on or off by applying 3.3 V or 0 V, respectively, to the EN pad. At EN = 3.3 V, VGATE drops to -1.5 V and VDRAIN turns on at 5 V. VGATE then rises until  $I_{DRAIN} = 800$  mA, and the closed control loop regulates  $I_{DRAIN}$  at 1600 mA. When EN = 0 V, VGATE is set to -1.5 V, and VDRAIN is set to 0 V (see Figure 57 and Figure 58).

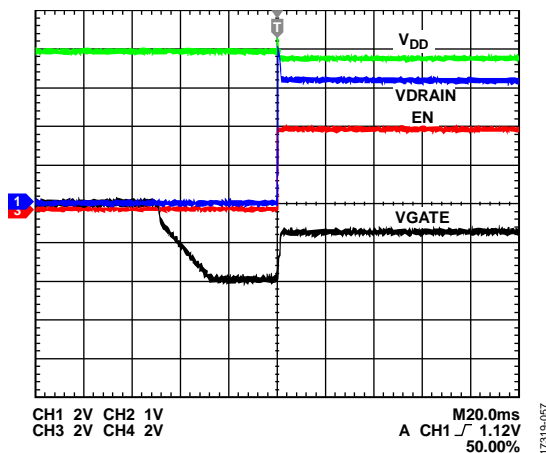

Figure 57. Turn On HMC980LP4E Outputs to ADPA7005CHIP

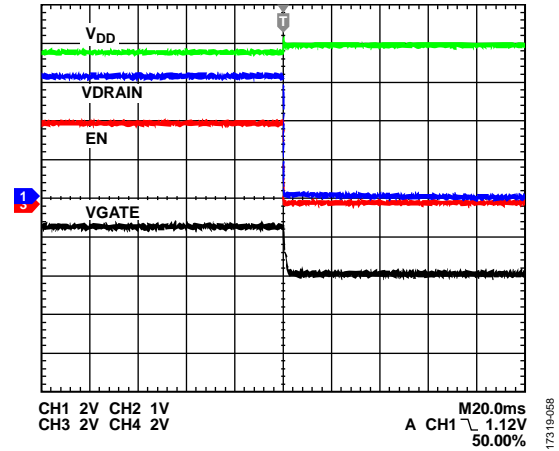

Figure 58. Turn Off HMC980LP4E Outputs to ADPA7005CHIP

### CONSTANT DRAIN CURRENT BIASING vs. CONSTANT GATE VOLTAGE BIASING

The HMC980LP4E uses a closed-loop feedback to continuously adjust VGATE to maintain a constant gate current bias over dc supply variation, temperature, and part to part variation. In addition, constant drain current bias is the optimum method for reducing time in calibration procedures and for maintaining consistent performance over time. By comparing with a constant gate voltage bias where the current is driven to increase when RF power is applied, a slightly lower output P1dB is seen with a constant drain current bias. This output P1dB is displayed in Figure 62, where the RF performance is slightly lower than constant gate voltage bias operation due to a lower drain current at the high input powers as the device reaches 1 dB compression.

The output P1dB performance for constant drain current bias can be increased towards constant gate voltage bias performance by increasing the set current towards the  $I_{DD}$  it would reach under RF drive in the constant gate voltage bias condition, as shown in Figure 62. The limit of increasing  $I_{DQ}$  under the constant current operation is set by the thermal limitations that can be found in the absolute maximum ratings table (see Table 3) from the amplifier data sheet with the maximum power dissipation specification. As the  $I_{DD}$  increase continues, the actual output P1dB does not continue to increase indefinitely, and the power dissipation increases. Therefore, take the exchange between the power dissipation and output P1dB performance into consideration when using constant drain current biasing.

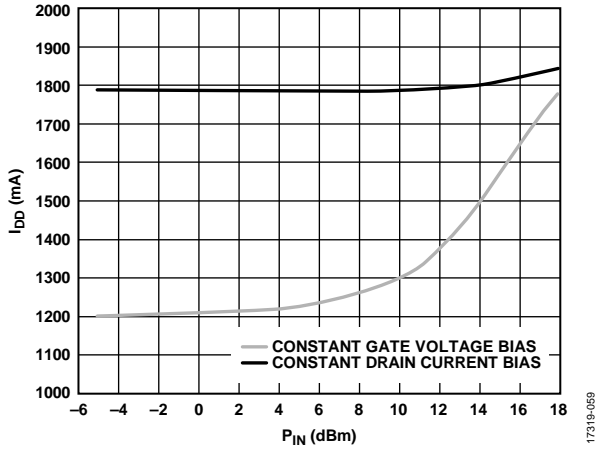

Figure 59.  $I_{DD}$  vs. RF Input Power ( $P_{IN}$ ),  $V_{DD} = 5\text{ V}$ , Frequency = 32 GHz for Constant Drain Current Bias and Constant Gate Voltage Bias

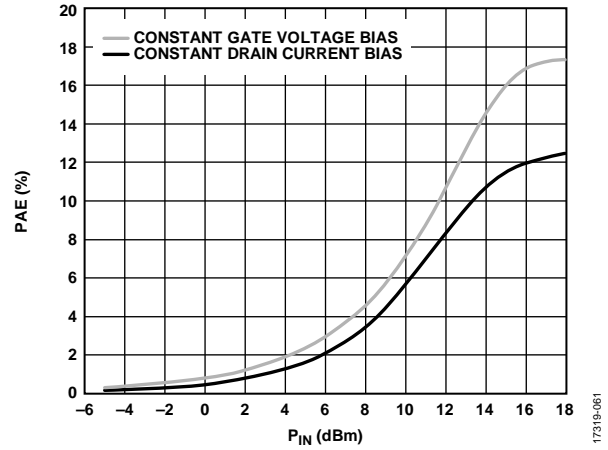

Figure 61. PAE vs.  $P_{IN}$ ,  $V_{DD} = 5\text{ V}$ , Frequency = 32 GHz, Constant Drain Current Bias and Constant Gate Voltage Bias

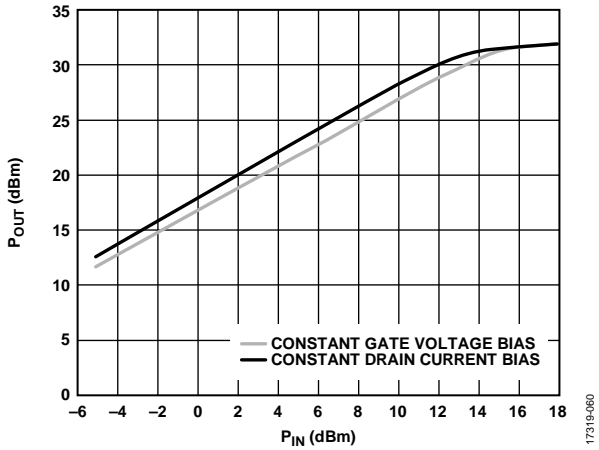

Figure 60.  $P_{OUT}$  vs.  $P_{IN}$ ,  $V_{DD} = 5\text{ V}$ , Frequency = 32 GHz, Constant Drain Current Bias and Constant Gate Voltage Bias

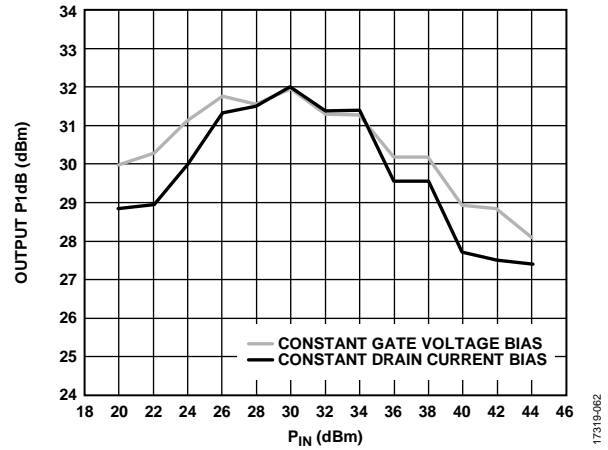

Figure 62. Output P1dB vs.  $P_{IN}$ ,  $V_{DD} = 5\text{ V}$ , Frequency = 32 GHz, Constant Drain Current Bias and Constant Gate Voltage Bias

TYPICAL APPLICATION CIRCUIT

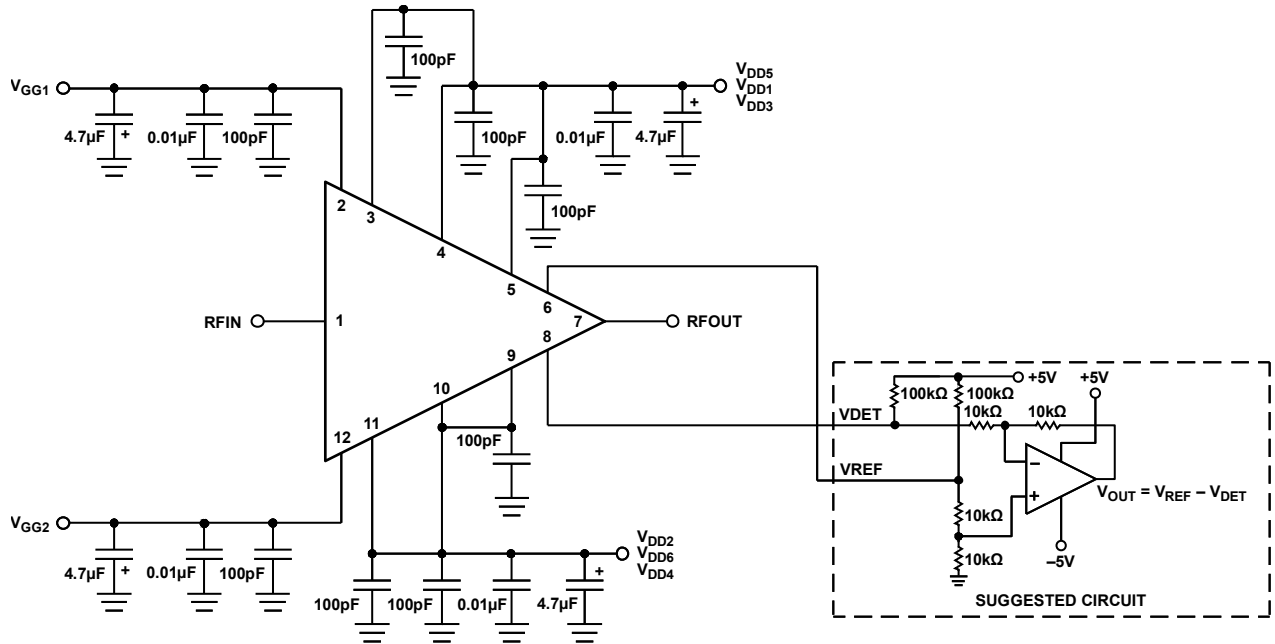

Figure 63. Typical Application Circuit Using the [HMC980LP4E](#) with the ADPA7005CHIP

17319-063

ASSEMBLY DIAGRAM

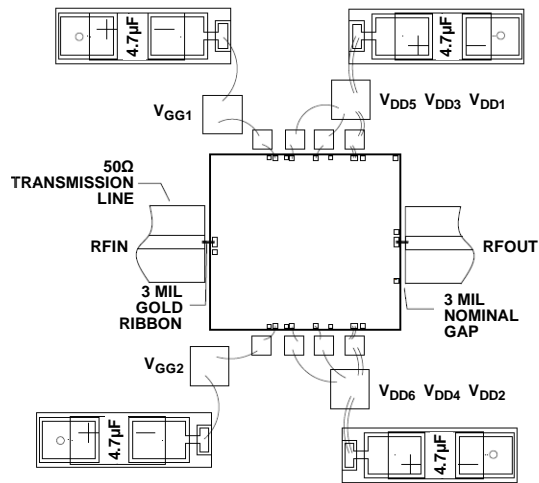
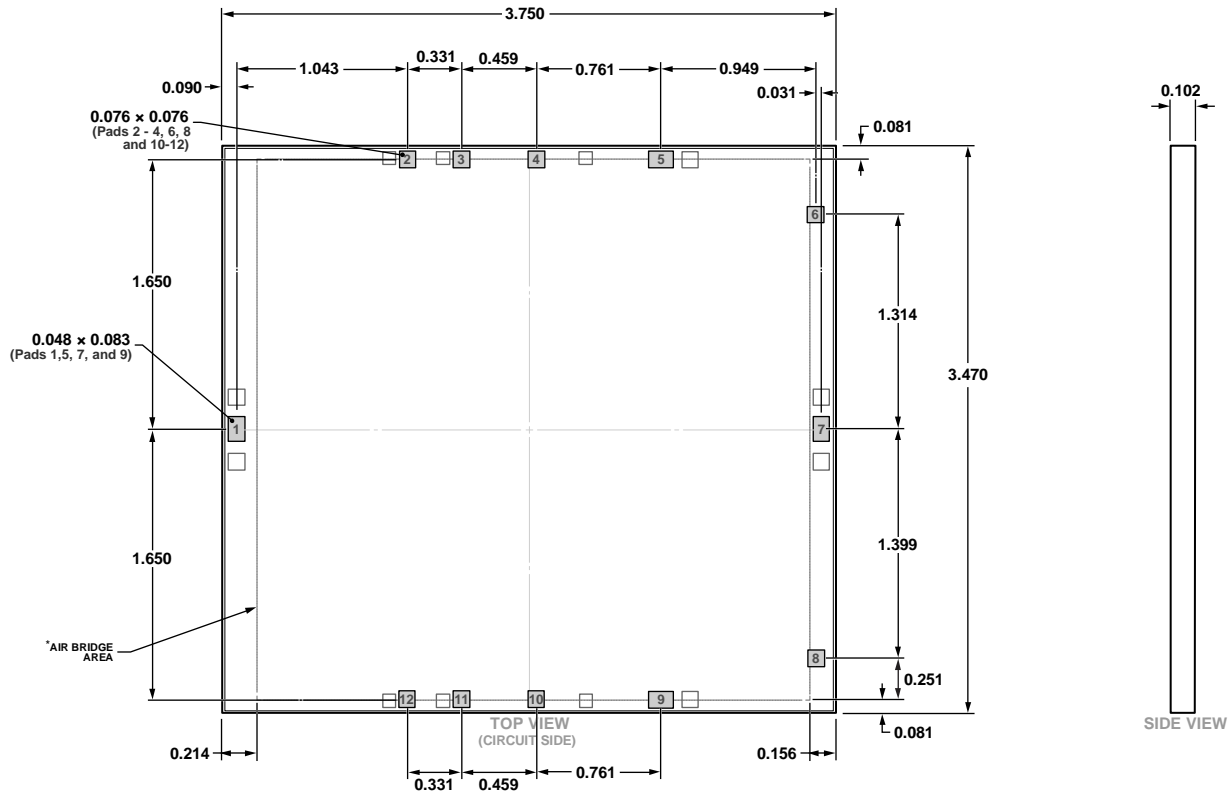

Figure 64. Assembly Diagram

17319-064

OUTLINE DIMENSIONS



\*This die utilizes fragile air bridges. Any pickup tools used must not contact this area.

Figure 65. 12-Pad Bare Die [CHIP]  
(C-12-3)  
Dimensions shown in millimeters

02-06-2019-B

ORDERING GUIDE

Model	Temperature Range	Package Description	Package Option
ADPA7005CHIP	-55°C to +85°C	12-Pad Bare Die [CHIP]	C-12-3
ADPA7005C-KIT	-55°C to +85°C	12-Pad Bare Die [CHIP]	C-12-3

## X-ON Electronics

Largest Supplier of Electrical and Electronic Components

*Click to view similar products for [RF Amplifier](#) category:*

*Click to view products by [Analog Devices](#) manufacturer:*

Other Similar products are found below :

[A82-1](#) [BGA622H6820XTSA1](#) [BGA 728L7 E6327](#) [BGB719N7ESDE6327XTMA1](#) [HMC397-SX](#) [HMC405](#) [HMC561-SX](#) [HMC8120-SX](#)  
[HMC8121-SX](#) [HMC-ALH382-SX](#) [HMC-ALH476-SX](#) [SE2433T-R](#) [SMA3101-TL-E](#) [SMA39](#) [A66-1](#) [A66-3](#) [A67-1](#) [A81-2](#) [LX5535LQ](#)  
[LX5540LL](#) [MAAM02350](#) [HMC3653LP3BETR](#) [HMC549MS8GETR](#) [HMC-ALH435-SX](#) [SMA101](#) [SMA32](#) [SMA411](#) [SMA531](#)  
[SST12LP19E-QX6E](#) [WPM0510A](#) [HMC5929LS6TR](#) [HMC5879LS7TR](#) [HMC1087F10](#) [HMC1086](#) [HMC1016](#) [SMA1212](#) [MAX2689EWS+T](#)  
[MAAMSS0041TR](#) [MAAM37000-A1G](#) [LTC6430AIUF-15#PBF](#) [SMA70-2](#) [SMA4011](#) [A231](#) [HMC-AUH232](#) [LX5511LQ](#) [LX5511LQ-TR](#)  
[HMC7441-SX](#) [HMC-ALH310](#) [XD1001-BD-000V](#) [A4011](#)