

## FEATURES

**Output P1dB:** 29 dBm typical at 34 GHz to 44 GHz

**P<sub>SAT</sub>:** 31.5 dBm typical at 26 GHz to 34 GHz

**Gain:** 20.5 dB typical at 34 GHz to 44 GHz

**Output IP3:** up to 42.5 dBm typical

**Supply voltage:** 5 V at 1400 mA

**50 Ω matched input/output**

**18-terminal, 7 mm × 7 mm LCC\_HS package**

**Integrated power detector**

## APPLICATIONS

**Military and space**

**Test instrumentation**

**Communications**

## GENERAL DESCRIPTION

The ADPA7007 is a gallium arsenide (GaAs), pseudomorphic high electron mobility transfer (pHEMT), monolithic microwave integrated circuit (MMIC), 31.5 dBm saturated output power (>1 W) power amplifier, with an integrated temperature compensated, on-chip power detector that operates between 20 GHz and 44 GHz. The ADPA7007 provides 20.5 dB of small signal gain and approximately 32 dBm of saturated output power at 32 GHz from a 5 V supply (see Figure 26). The ADPA7007 has an output IP3 of 42.5 dBm and is ideal for linear

## FUNCTIONAL BLOCK DIAGRAM

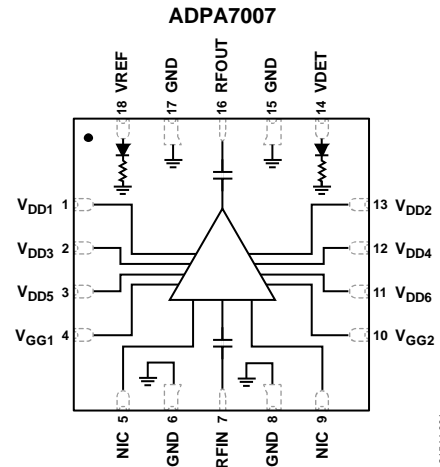

Figure 1.

applications such as electronic countermeasure and instrumentation applications requiring >30 dBm of efficient saturated output power. The RF input/outputs are internally matched and dc blocked for ease of integration into higher level assemblies. The ADPA7007 is packaged in a **7 mm × 7 mm, 18-terminal ceramic leadless chip carrier with heat sink (LCC\_HS)** that exhibits low thermal resistance and is compatible with surface-mount manufacturing techniques.

## TABLE OF CONTENTS

Features .....	1	Typical Performance Characteristics .....	8
Applications .....	1	Constant I <sub>DD</sub> Operation .....	15
Functional Block Diagram .....	1	Theory of Operation .....	16
General Description .....	1	Applications Information .....	17
Revision History .....	2	Biasing ADPA7007 with the HMC980LP4E .....	18
Specifications .....	3	Application Circuit Setup .....	18
20 GHz to 26 GHz Frequency Range .....	3	Limiting VGATE and VNEG for ADPA7007 V <sub>GGx</sub> Absolute Maximum Rating Requirement .....	18
26 GHz to 34 GHz Frequency Range .....	3	HMC980LP4E Bias Sequence.....	21
34 GHz to 44 GHz Frequency Range .....	4	Constant Drain Current Biasing vs. Constant Gate Voltage Biasing.....	21
Absolute Maximum Ratings .....	5	Outline Dimensions.....	23
Thermal Resistance .....	5	Ordering Guide .....	23
Electrostatic Discharge (ESD) Ratings .....	5		
ESD Caution.....	5		
Pin Configuration and Function Descriptions .....	6		
Interface Schematics .....	7		

## REVISION HISTORY

7/2020—Revision 0: Initial Version

**SPECIFICATIONS****20 GHz TO 26 GHz FREQUENCY RANGE**

$T_A = 25^\circ\text{C}$ , drain bias voltage ( $V_{DD}$ ) = 5 V, and quiescent drain current ( $I_{DQ}$ ) = 1400 mA for nominal operation, unless otherwise noted. 50  $\Omega$  matched input/output.

Table 1.

Parameter	Symbol	Min	Typ	Max	Unit	Test Conditions/Comments
FREQUENCY RANGE		20		26	GHz	
GAIN		18	20		dB	
Gain Flatness			$\pm 1$		dB	
Gain Variation over Temperature			0.021		dB/ $^\circ\text{C}$	
NOISE FIGURE			6		dB	
RETURN LOSS						
Input			12		dB	
Output			12		dB	
OUTPUT						
Output Power for 1 dB Compression	P1dB	26.5	29		dBm	Measurement taken at output power ( $P_{OUT}$ ) per tone = 16 dBm
Saturated Output Power	$P_{SAT}$		30		dBm	
Output Third-Order Intercept	IP3		39		dBm	
POWER ADDED EFFICIENCY	PAE		11		%	Measured at $P_{SAT}$
SUPPLY						Adjust $V_{GGX}$ from $-1.5$ V up to 0 V to achieve the desired $I_{DQ}$ , $V_{GGX} = -0.685$ V typical to achieve $I_{DQ} = 1400$ mA
Quiescent Drain Current	$I_{DQ}$		1400		mA	
Drain Bias Voltage	$V_{DD}$	4	5		V	

**26 GHz TO 34 GHz FREQUENCY RANGE**

$T_A = 25^\circ\text{C}$ ,  $V_{DD} = 5$  V, and  $I_{DQ} = 1400$  mA for nominal operation, unless otherwise noted. 50  $\Omega$  matched input/output.

Table 2.

Parameter	Symbol	Min	Typ	Max	Unit	Test Conditions/Comments
FREQUENCY RANGE		26		34	GHz	
GAIN		19.5	21.5		dB	
Gain Flatness			$\pm 0.5$		dB	
Gain Variation over Temperature			0.021		dB/ $^\circ\text{C}$	
NOISE FIGURE			5.5		dB	
RETURN LOSS						
Input			13		dB	
Output			13		dB	
OUTPUT						
Output Power for 1 dB Compression	P1dB	28	30		dBm	Measurement taken at $P_{OUT}$ per tone = 16 dBm
Saturated Output Power	$P_{SAT}$		31.5		dBm	
Output Third-Order Intercept	IP3		42.5		dBm	
POWER ADDED EFFICIENCY	PAE		14		%	Measured at $P_{SAT}$
SUPPLY						Adjust $V_{GGX}$ from $-1.5$ V up to 0 V to achieve the desired $I_{DQ}$ , $V_{GGX} = -0.685$ V typical to achieve $I_{DQ} = 1400$ mA
Current	$I_{DQ}$		1400		mA	
Voltage	$V_{DD}$	4	5		V	

**34 GHz TO 44 GHz FREQUENCY RANGE**

$T_A = 25^\circ\text{C}$ ,  $V_{DD} = 5\text{ V}$ , and  $I_{DQ} = 1400\text{ mA}$  for nominal operation, unless otherwise noted.  $50\ \Omega$  matched input/output.

Table 3.

Parameter	Symbol	Min	Typ	Max	Unit	Test Conditions/Comments
FREQUENCY RANGE		34		44	GHz	
GAIN		18.5	20.5		dB	
Gain Flatness			$\pm 1$		dB	
Gain Variation over Temperature			0.04		dB/ $^\circ\text{C}$	
NOISE FIGURE		6			dB	
RETURN LOSS						
Input			15		dB	
Output			18		dB	
OUTPUT						
Output Power for 1 dB Compression	P1dB	28.5	29		dBm	
Saturated Output Power	$P_{SAT}$		31		dBm	
Output Third-Order Intercept	IP3		41		dBm	Measurement taken at $P_{OUT}$ per tone = 16 dBm
POWER ADDED EFFICIENCY	PAE		13		%	Measured at $P_{SAT}$
SUPPLY						Adjust $V_{GGx}$ from $-1.5\text{ V}$ up to $0\text{ V}$ to achieve the desired $I_{DQ}$ , $V_{GGx} = -0.685\text{ V}$ typical to achieve $I_{DQ} = 1400\text{ mA}$
Current	$I_{DQ}$		1400		mA	
Voltage	$V_{DD}$	4	5		V	

## ABSOLUTE MAXIMUM RATINGS

Table 4.

Parameter	Rating
Drain Bias Voltage ( $V_{DDx}$ )	6.0 V
Gate Bias Voltage ( $V_{GGx}$ )	-1.6 V to 0 V
Radio Frequency Input Power (RFIN)	27 dBm
Continuous Power Dissipation ( $P_{DISS}$ ), T = 85°C (Derate 137 mW/°C Above 85°C)	12.33 W
Storage Temperature Range	-55°C to +150°C
Operating Temperature Range	-40°C to +85°C
Junction Temperature to Maintain 1,000,000 Hour Mean Time to Failure (MTTF)	175°C
Nominal Junction Temperature (T = 85°C, $V_{DD} = 5$ V, $I_{DQ} = 1400$ mA)	136.1°C
Peak Reflow Temperature <sup>1</sup>	260°C
Moisture Sensitivity Level	MSL3

<sup>1</sup> See the Ordering Guide for additional information.

Stresses at or above those listed under Absolute Maximum Ratings may cause permanent damage to the product. This is a stress rating only; functional operation of the product at these or any other conditions above those indicated in the operational section of this specification is not implied. Operation beyond the maximum operating conditions for extended periods may affect product reliability.

## THERMAL RESISTANCE

Thermal performance is directly linked to system design and operating environment. Careful attention to the printed circuit board (PCB) thermal design is required.

$\theta_{JC}$  is the channel to case thermal resistance, channel to bottom of die using die attach epoxy.

Table 5. Thermal Resistance

Package Type	$\theta_{JC}$	Unit
EH-18-1 <sup>1</sup>	7.3	°C/W

<sup>1</sup>  $\theta_{JC}$  is determined by simulation under the following conditions: the heat transfer is due solely to thermal conduction from the channel, through the ground pad, to the PCB. The ground pad is held constant at the operating temperature of 85°C.

## ELECTROSTATIC DISCHARGE (ESD) RATINGS

The following ESD information is provided for handling of ESD sensitive devices in an ESD protected area only.

Human body model (HBM) per ANSI/ESDA/JEDEC JS-001.

### ESD Ratings for ADPA7007

Table 6. ADPA7007, 18-Terminal LCC\_HS

ESD Model	Withstand Threshold (V)	Class
HBM	250	1A

## ESD CAUTION



**ESD (electrostatic discharge) sensitive device.** Charged devices and circuit boards can discharge without detection. Although this product features patented or proprietary protection circuitry, damage may occur on devices subjected to high energy ESD. Therefore, proper ESD precautions should be taken to avoid performance degradation or loss of functionality.

## PIN CONFIGURATION AND FUNCTION DESCRIPTIONS

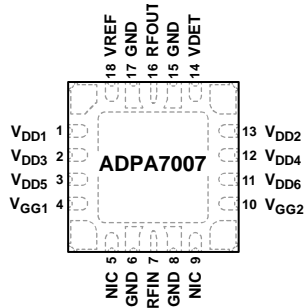

- NOTES
1. NIC = NO INTERNAL CONNECTION. NOTE THAT DATA SHOWN HEREIN WAS MEASURED WITH THESE PINS EXTERNALLY CONNECTED TO RF AND DC GROUND.
  2. EXPOSED PAD. THE EXPOSED PAD MUST BE CONNECTED TO RF AND DC GROUND.

21544-002

Figure 2. Pin Configuration

Table 7. Pin Function Descriptions

Pin No.	Mnemonic	Description
1, 2, 3, 11, 12, 13	VDD1, VDD3, VDD5, VDD6, VDD4, VDD2	Drain Bias for the Amplifier.
4, 10	VGG1, VGG2	Amplifier Gate Control. ESD protection diodes are included and turn on below $-1.5$ V.
5, 9	NIC	Not Internally Connected. Note that data shown herein was measured with these pins externally connected to RF and dc ground.
6, 8, 15, 17	GND	Ground Pins. Connect the GND pins and the exposed pad to RF and dc ground.
7	RFIN	RF Signal Input. This pin is ac-coupled and internally matched to $50 \Omega$ .
14	VDET	Detector Diode Used for Measuring the RF Output Power. Detection via VDET requires the application of a dc bias voltage through an external series resistor. Used in combination with VREF, the difference voltage, $VREF - VDET$ , is a temperature compensated dc voltage proportional to the RF output power.
16	RFOUT	RF Signal Output. RFOUT is ac-coupled and internally matched to $50 \Omega$ .
18	VREF	Reference Diode Used for Temperature Compensation of VDET RF Output Power Measurements. Detection via VREF requires the application of a dc bias voltage through an external series resistor. Used in combination with VDET, this voltage provides temperature compensation to VDET RF output power measurements.
	EPAD	Exposed Pad. The exposed pad must be connected to RF and dc ground.

INTERFACE SCHEMATICS



Figure 3. GND Interface Schematic

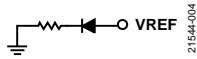

Figure 4. VREF Interface Schematic

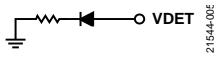

Figure 5. VDET Interface Schematic

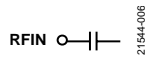

Figure 6. RFIN Interface Schematic

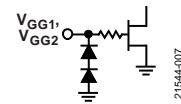

Figure 7.  $V_{GG1}$ ,  $V_{GG2}$  Interface Schematic

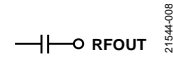

Figure 8. RFOUT Interface Schematic

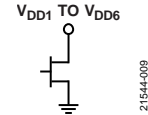

Figure 9.  $V_{DD1}$  to  $V_{DD6}$  Interface Schematic

TYPICAL PERFORMANCE CHARACTERISTICS

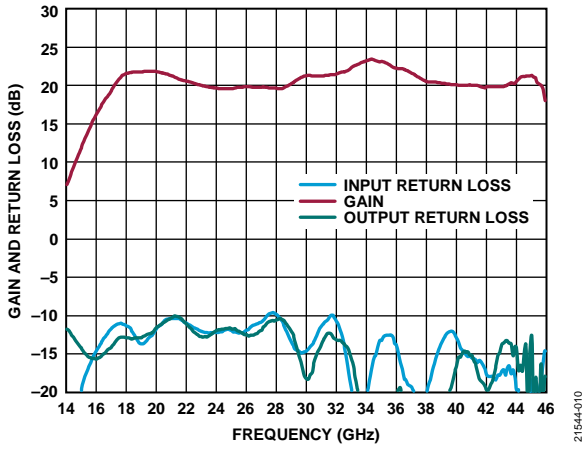

Figure 10. Gain and Return Loss vs. Frequency,  $V_{DD} = 5\text{ V}$ ,  $I_{DQ} = 1400\text{ mA}$

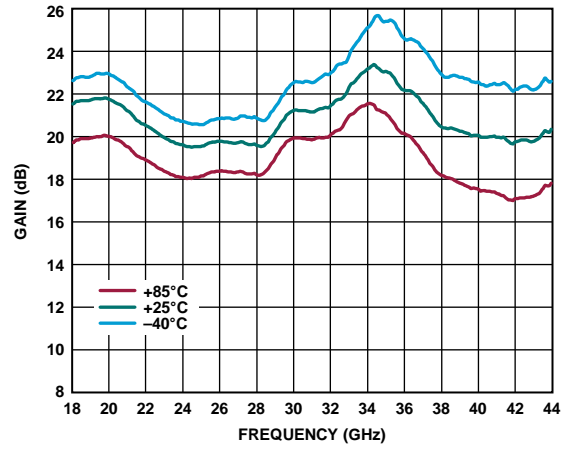

Figure 13. Gain vs. Frequency for Various Temperatures,  $V_{DD} = 5\text{ V}$ ,  $I_{DQ} = 1400\text{ mA}$

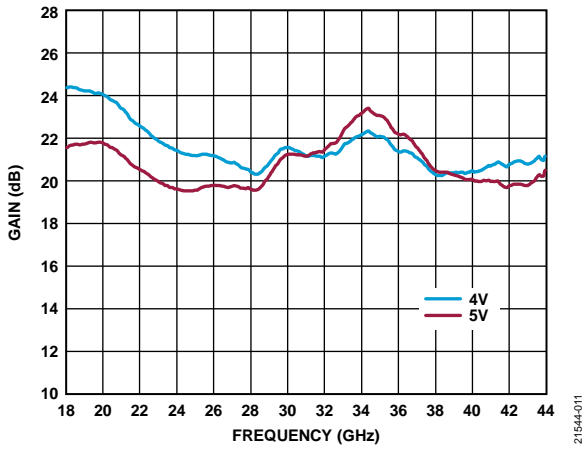

Figure 11. Gain vs. Frequency for Various  $V_{DD}$ ,  $I_{DQ} = 1400\text{ mA}$

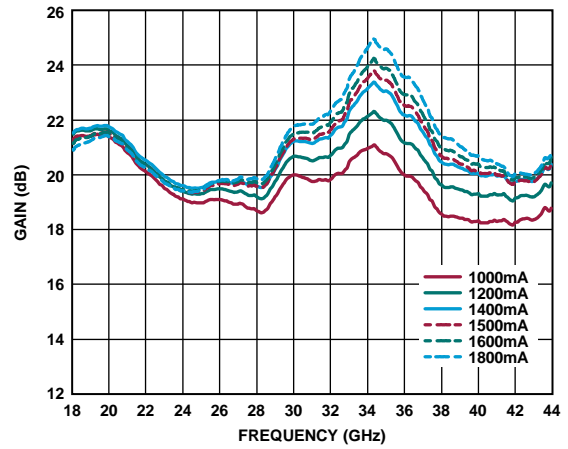

Figure 14. Gain vs. Frequency for Various  $I_{DQ}$ ,  $V_{DD} = 5\text{ V}$

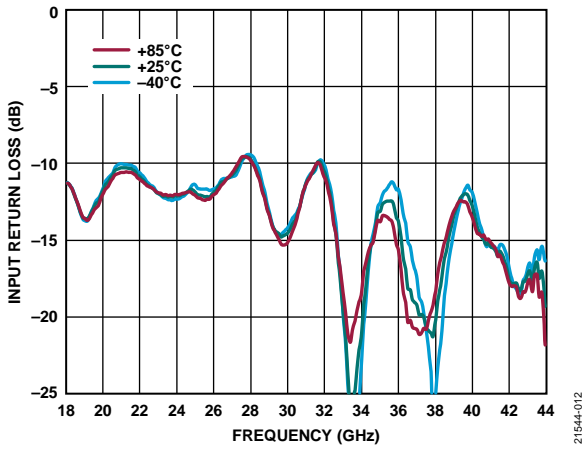

Figure 12. Input Return Loss vs. Frequency for Various Temperatures,  $V_{DD} = 5\text{ V}$ ,  $I_{DQ} = 1400\text{ mA}$

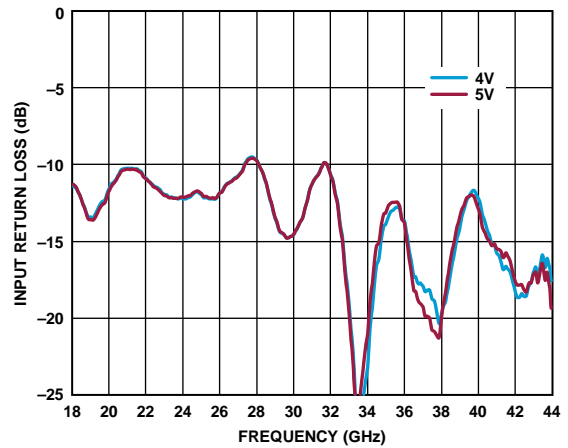

Figure 15. Input Return Loss vs. Frequency for Various  $V_{DD}$ ,  $I_{DQ} = 1400\text{ mA}$



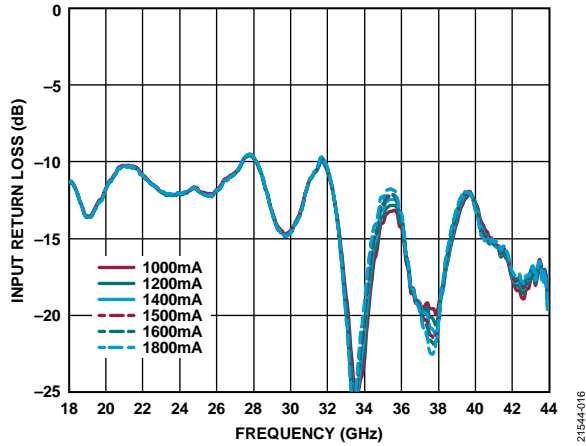

Figure 16. Input Return Loss vs. Frequency for Various  $I_{DQ}$ ,  $V_{DD} = 5 V$

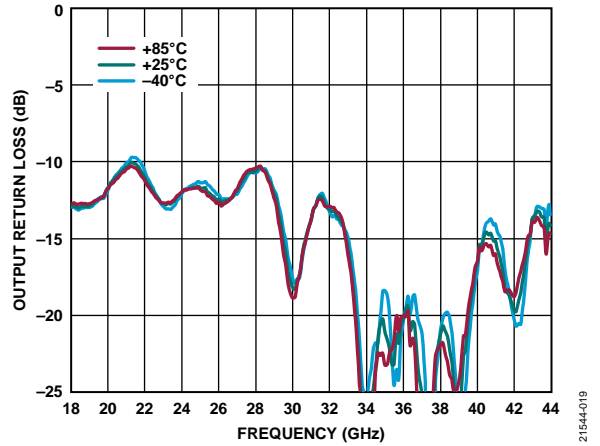

Figure 19. Output Return Loss vs. Frequency for Various Temperature,  $V_{DD} = 5 V$ ,  $I_{DQ} = 1400 mA$

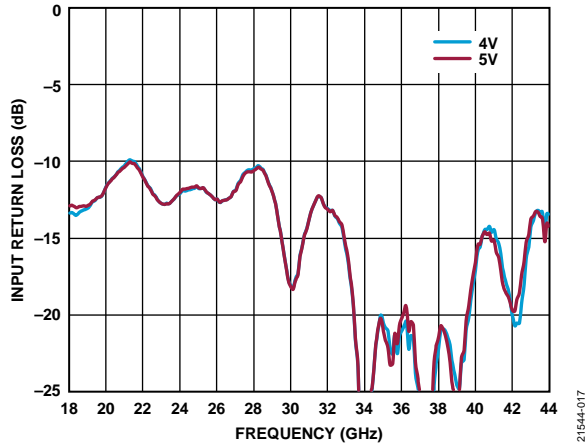

Figure 17. Input Return Loss vs Frequency for Various  $V_{DD}$ ,  $I_{DQ} = 1400 mA$

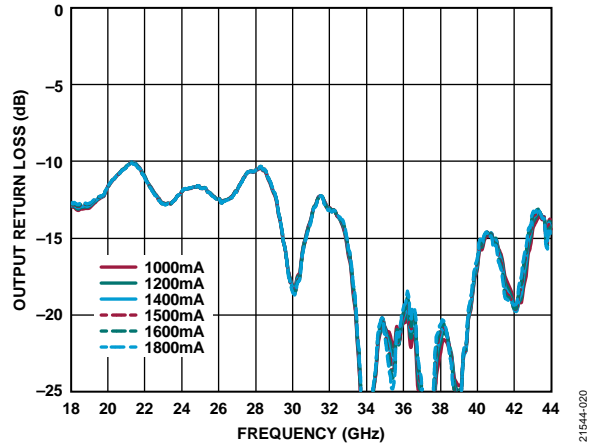

Figure 20. Output Return Loss vs. Frequency for Various  $I_{DQ}$ ,  $V_{DD} = 5 V$

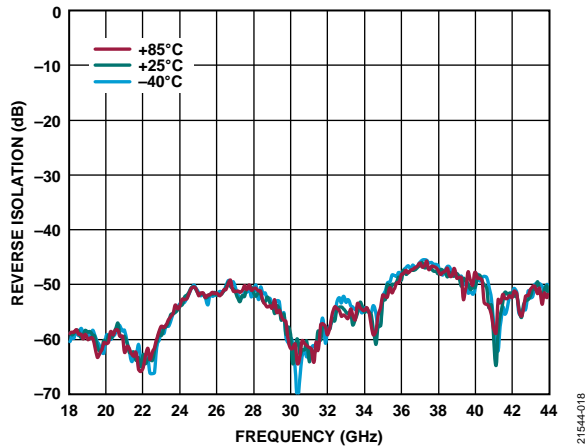

Figure 18. Reverse Isolation vs. Frequency for Various Temperatures,  $V_{DD} = 5 V$ ,  $I_{DQ} = 1400 mA$

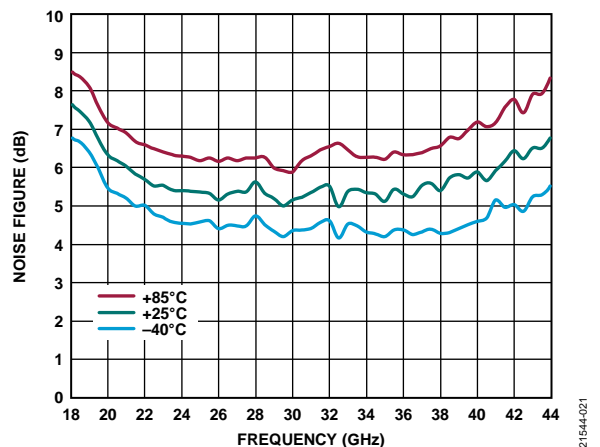

Figure 21. Noise Figure vs. Frequency for Various Temperatures,  $V_{DD} = 5 V$ ,  $I_{DQ} = 1400 mA$

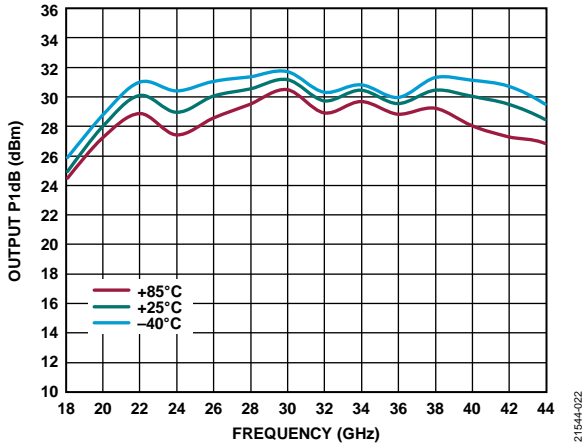

Figure 22. Output P1dB vs. Frequency for Various Temperatures,  $V_{DD} = 5V, I_{DQ} = 1400\text{ mA}$

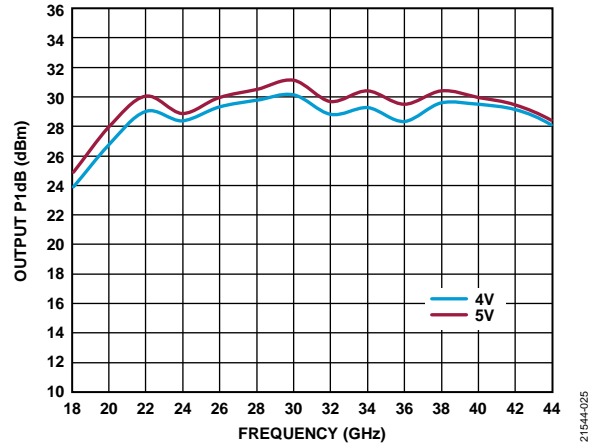

Figure 25. Output P1dB vs. Frequency for Various  $V_{DD}$ ,  $I_{DQ} = 1400\text{ mA}$

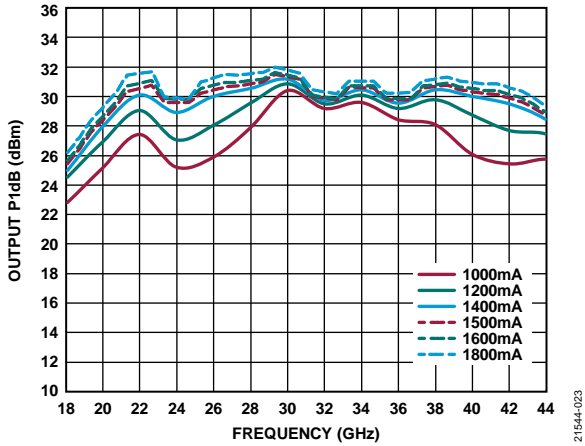

Figure 23. Output P1dB vs. Frequency for Various  $I_{DQ}$ ,  $V_{DD} = 5V$

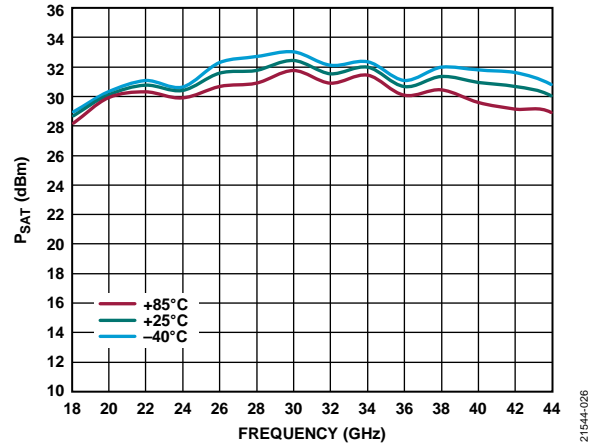

Figure 26.  $P_{SAT}$  vs. Frequency for Various Temperatures,  $V_{DD} = 5V, I_{DQ} = 1400\text{ mA}$

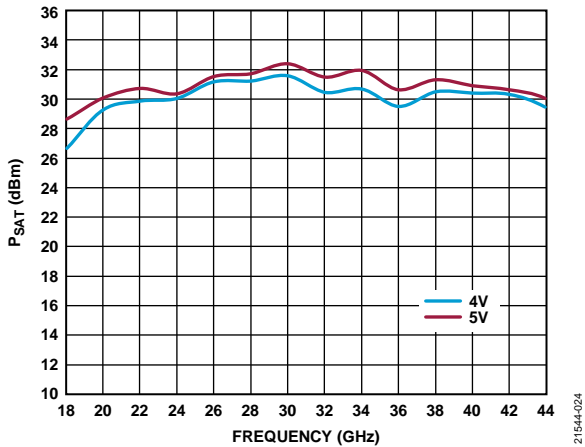

Figure 24.  $P_{SAT}$  vs. Frequency for Various  $V_{DD}$ ,  $I_{DQ} = 1400\text{ mA}$

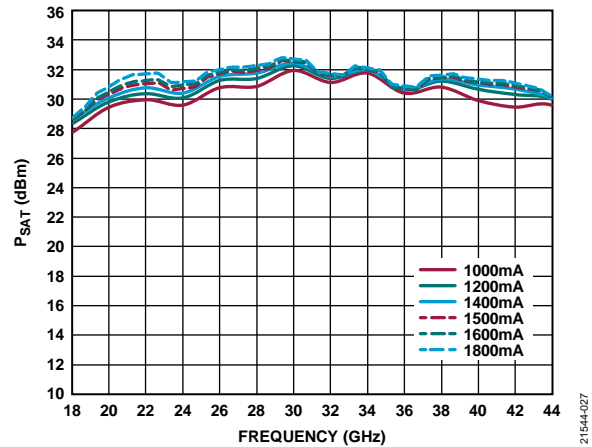

Figure 27.  $P_{SAT}$  vs. Frequency for Various  $I_{DQ}$ ,  $V_{DD} = 5V$

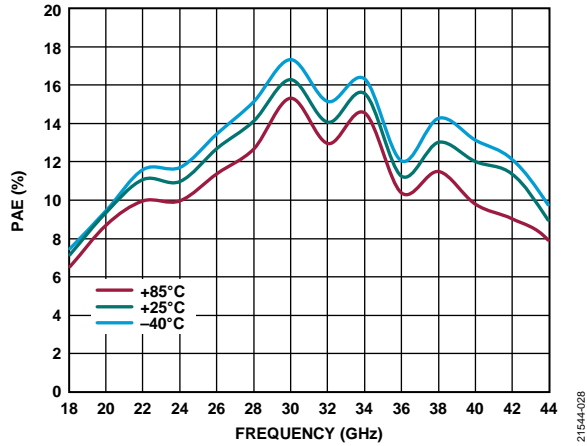

Figure 28. Power Added Efficiency (PAE) vs. Frequency for Various Temperatures,  $V_{DD} = 5V$ ,  $I_{DQ} = 1400\text{ mA}$ , PAE Measured at  $P_{SAT}$

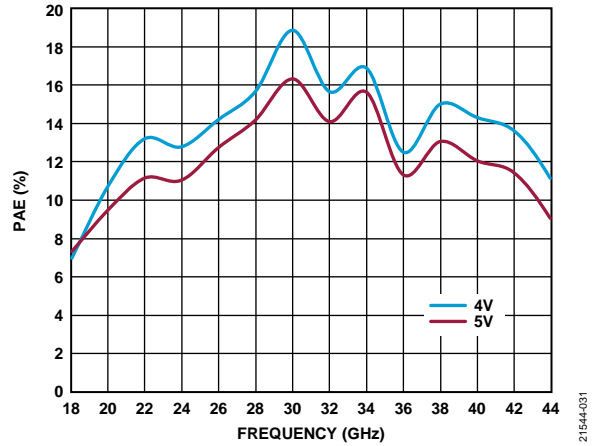

Figure 31. PAE vs. Frequency for Various  $V_{DD}$ ,  $I_{DQ} = 1400\text{ mA}$ , PAE Measured at  $P_{SAT}$

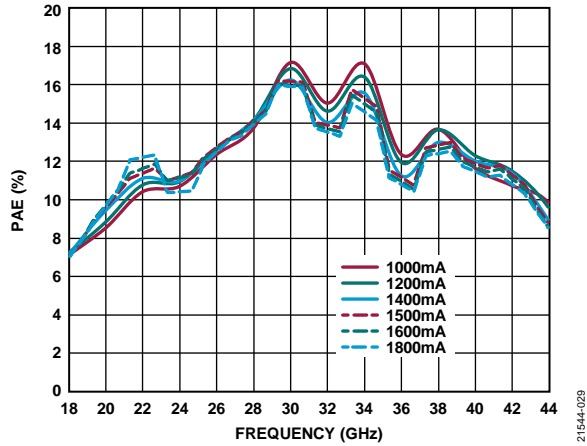

Figure 29. PAE vs. Frequency for Various  $I_{DQ}$ ,  $V_{DD} = 5V$ ,  $I_{DQ} = 1400\text{ mA}$ , PAE Measured at  $P_{SAT}$

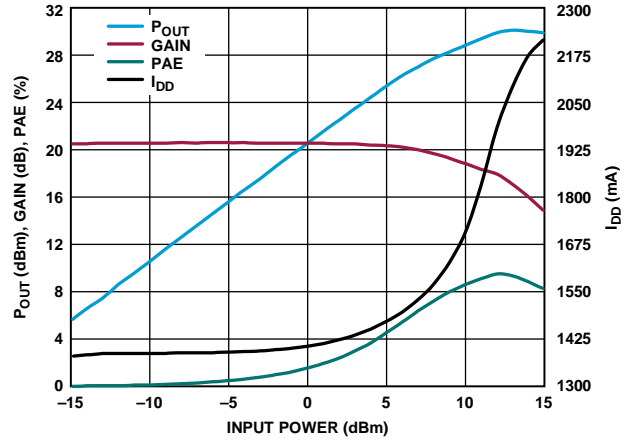

Figure 32.  $P_{OUT}$ , Gain, PAE, and  $I_{DD}$  vs. Input Power, 20 GHz,  $V_{DD} = 5V$ ,  $I_{DD} = 1400\text{ mA}$

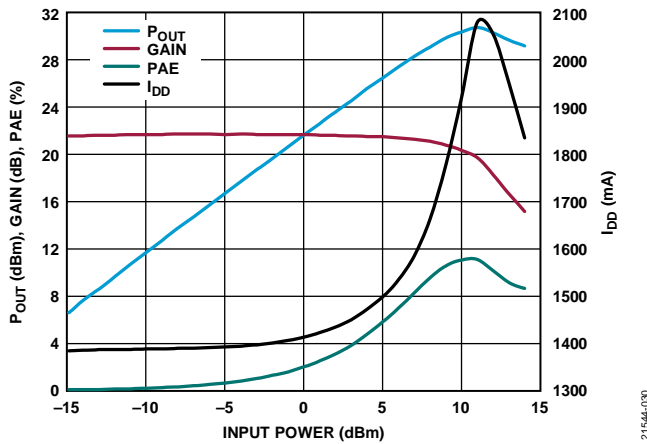

Figure 30.  $P_{OUT}$ , Gain, PAE, and Drain Current with RF Applied ( $I_{DD}$ ) vs. Input Power, 22 GHz,  $V_{DD} = 5V$ ,  $I_{DD} = 1400\text{ mA}$

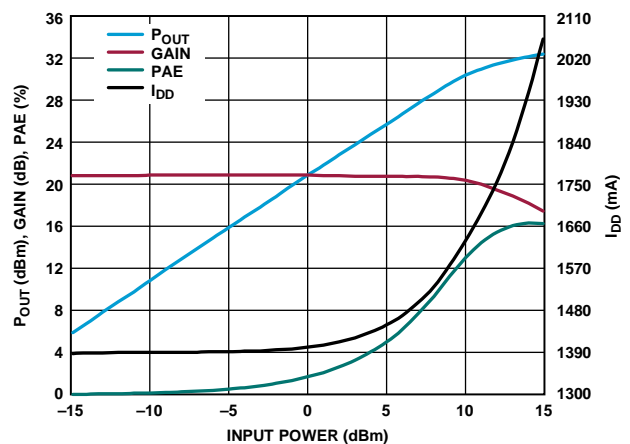

Figure 33.  $P_{OUT}$ , Gain, PAE, and  $I_{DD}$  vs. Input Power, 30 GHz,  $V_{DD} = 5V$ ,  $I_{DD} = 1400\text{ mA}$

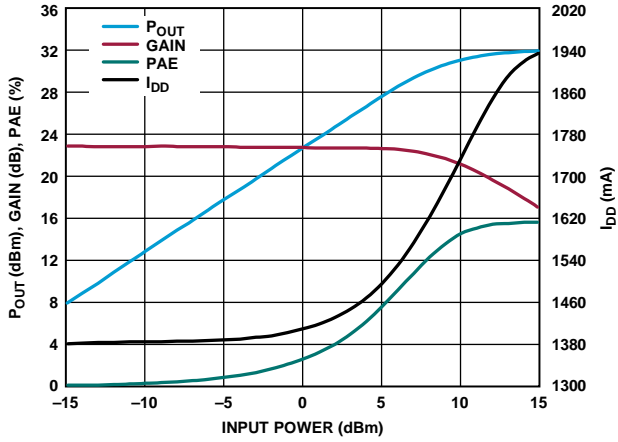

Figure 34.  $P_{OUT}$ , Gain, PAE, and  $I_{DD}$  vs. Input Power, 34 GHz,  $V_{DD} = 5\text{ V}$ ,  $I_{DD} = 1400\text{ mA}$

21544-034

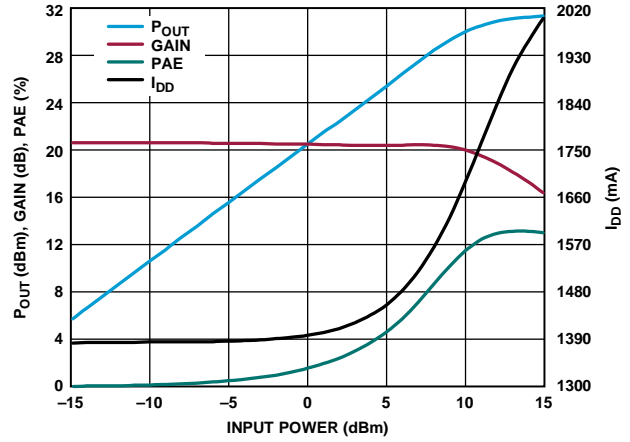

Figure 37.  $P_{OUT}$ , Gain, PAE, and  $I_{DD}$  vs. Input Power, 38 GHz,  $V_{DD} = 5\text{ V}$ ,  $I_{DD} = 1400\text{ mA}$

21544-037

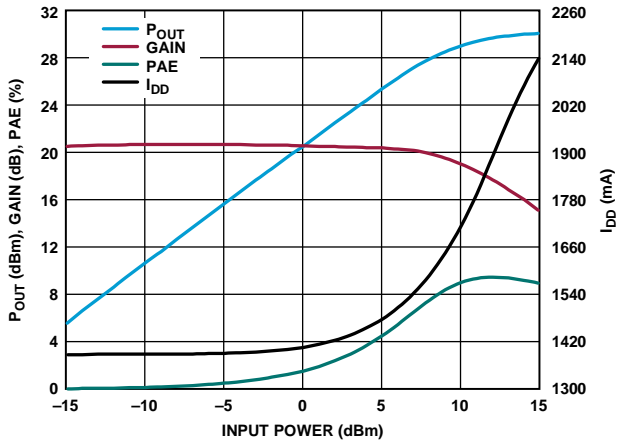

Figure 35.  $P_{OUT}$ , Gain, PAE, and  $I_{DD}$  vs. Input Power, 44 GHz,  $V_{DD} = 5\text{ V}$ ,  $I_{DD} = 1400\text{ mA}$

21544-035

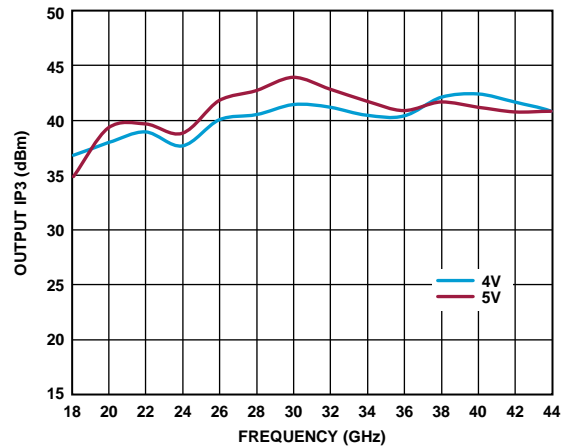

Figure 38. Output IP3 vs. Frequency for Various  $V_{DD}$ ,  $P_{OUT}$  per Tone = 16 dBm,  $I_{DQ} = 1400\text{ mA}$

21544-038

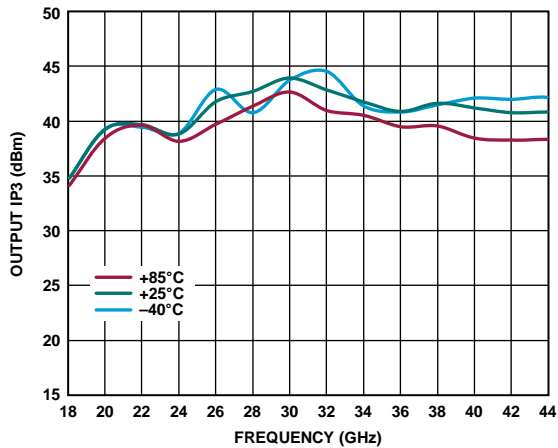

Figure 36. Output IP3 vs. Frequency for Various Temperatures,  $P_{OUT}$  per Tone = 16 dBm,  $V_{DD} = 5\text{ V}$ ,  $I_{DQ} = 1400\text{ mA}$

21544-036

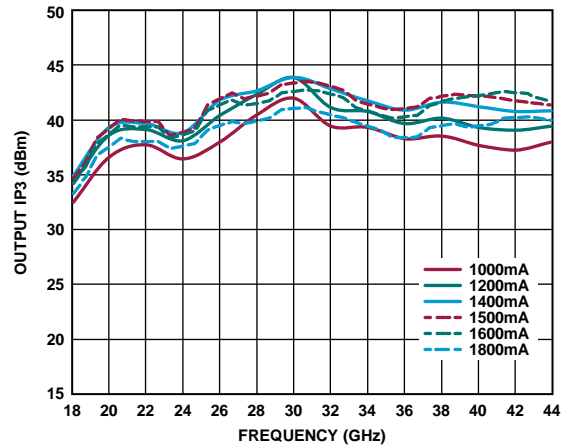

Figure 39. Output IP3 vs. Frequency for Various  $I_{DQ}$ ,  $P_{OUT}$  per Tone = 16 dBm,  $V_{DD} = 5\text{ V}$

21544-039

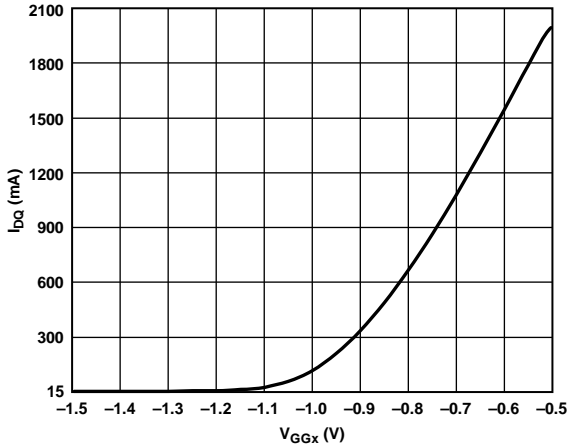

Figure 40.  $I_{DQ}$  vs.  $V_{GGx}$

21544-040

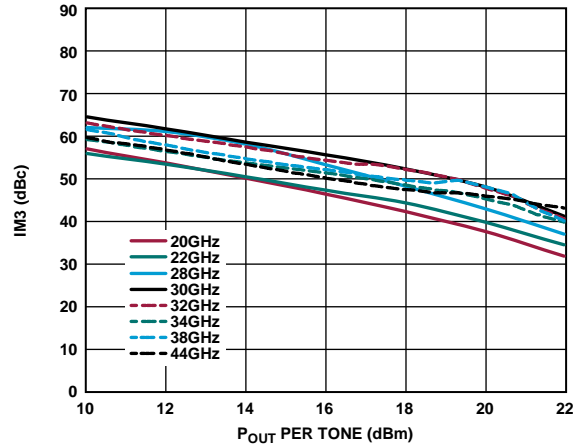

Figure 43. IM3 vs.  $P_{OUT}$  per Tone,  $V_{DD} = 5\text{ V}$ ,  $I_{DQ} = 1400\text{ mA}$

21544-043

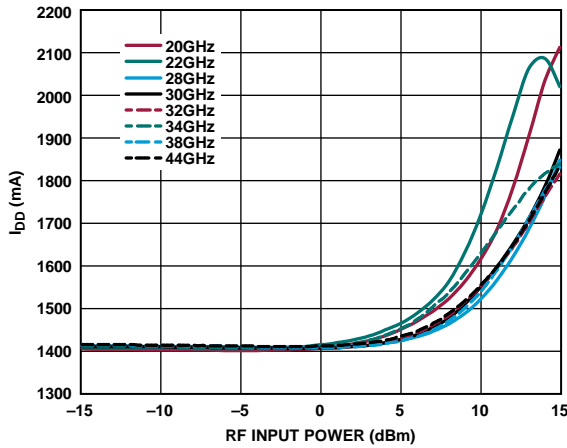

Figure 41.  $I_{DD}$  vs. RF Input Power at Various Frequencies,  $V_{DD} = 5\text{ V}$ ,  $I_{DQ} = 1400\text{ mA}$

21544-041

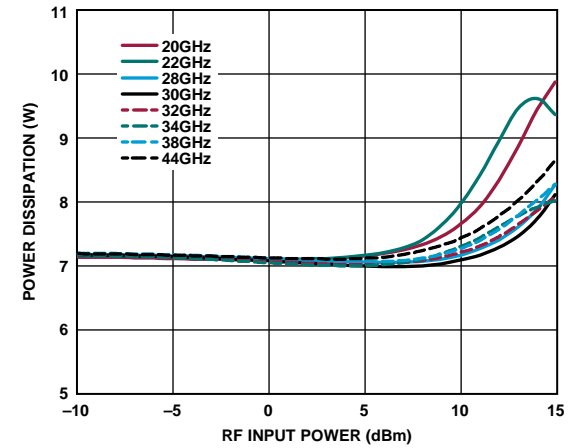

Figure 44. Power Dissipation vs. RF Input Power at  $T_A = 85^\circ\text{C}$ ,  $V_{DD} = 5\text{ V}$ ,  $I_{DQ} = 1400\text{ mA}$

21544-044

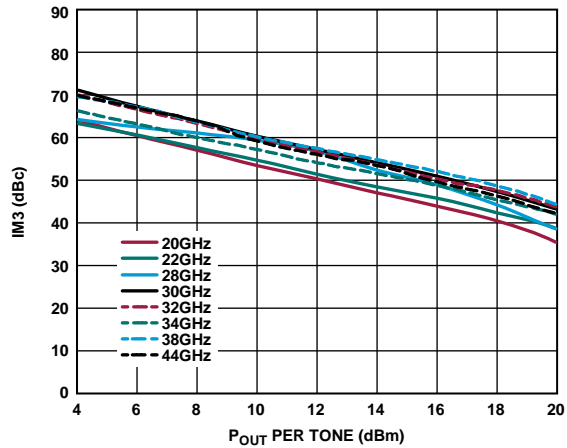

Figure 42. Third-Order Intermodulation Distortion (IM3) vs.  $P_{OUT}$  per Tone,  $V_{DD} = 4\text{ V}$ ,  $I_{DQ} = 1400\text{ mA}$

21544-042

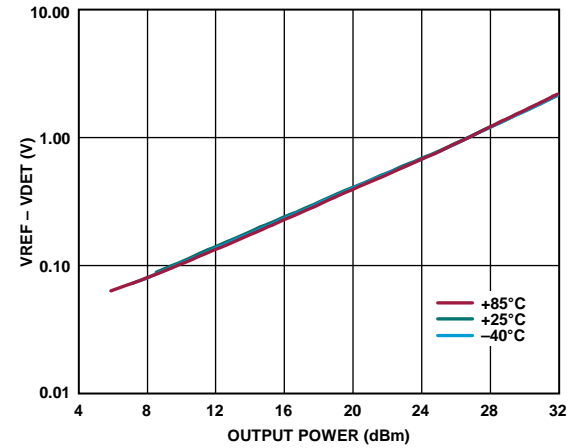

Figure 45.  $V_{REF} - V_{DET}$  vs. Output Power for Various Temperatures at 30 GHz

21544-045

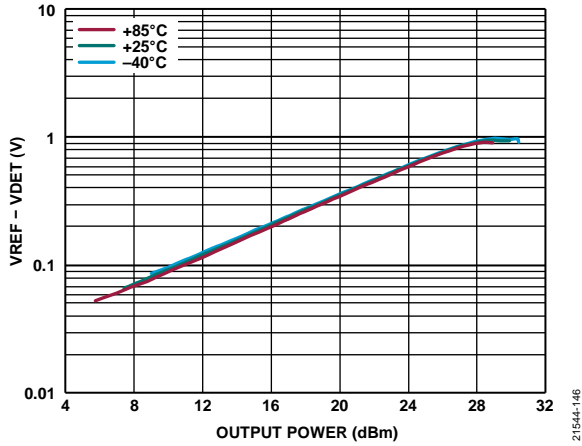

Figure 46. VREF – VDET vs. Output Power for Various Temperatures at 20 GHz

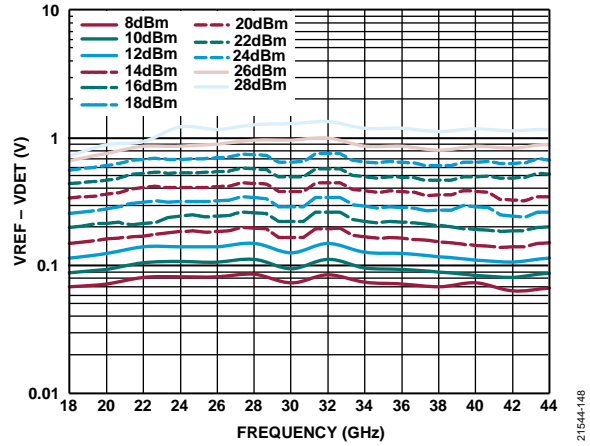

Figure 48. VREF – VDET vs. Frequency for Various P<sub>OUT</sub> Levels

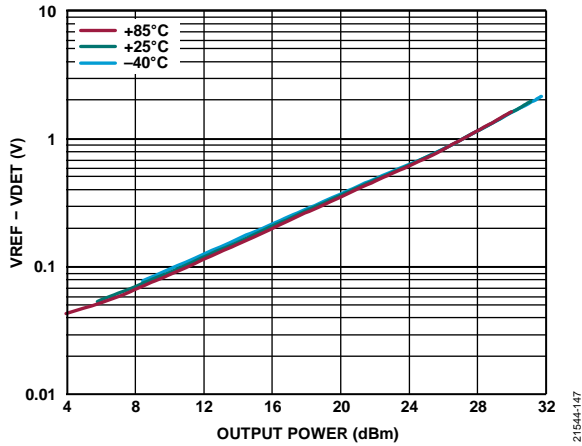

Figure 47. VREF – VDET vs. Output Power for Various Temperatures at 40 GHz

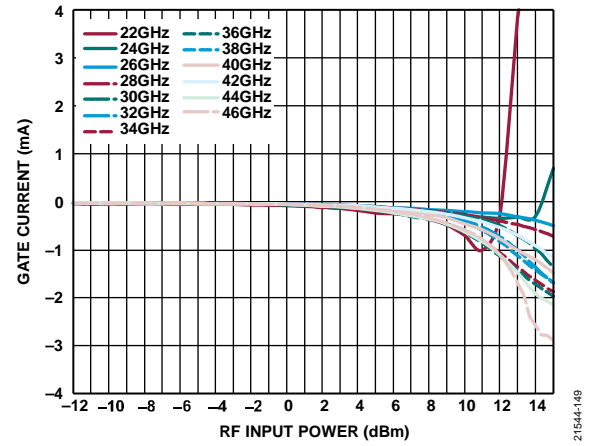

Figure 49. Gate Current ( $I_{GG}$ ) vs. RF Input Power at Various Frequencies,  $V_{DD} = 5V$ ,  $I_{DQ} = 1400mA$

**CONSTANT I<sub>DD</sub> OPERATION**

Biased with HMC980LP4E active bias controller (see Figure 56), T<sub>A</sub> = 25°C, V<sub>DD</sub> = 5 V, and I<sub>DD</sub> = 1800 mA for nominal operation, unless otherwise noted. Data measured with constant I<sub>DD</sub>.

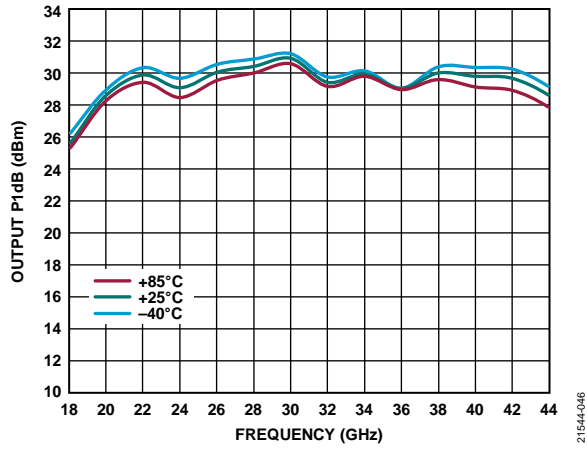

Figure 50. Output P1dB vs. Frequency for Various Temperatures

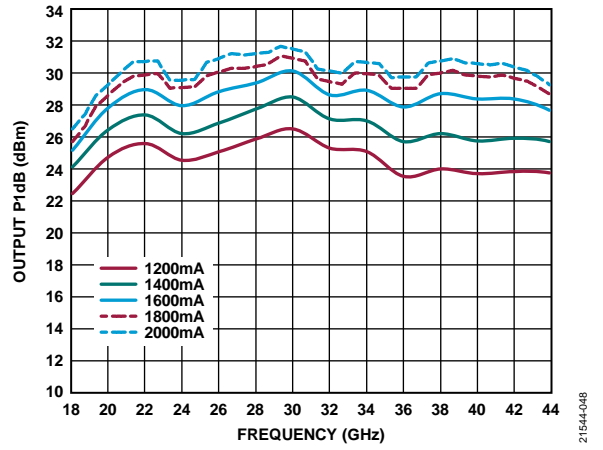

Figure 52. Output P1dB vs. Frequency for Various Drain Currents

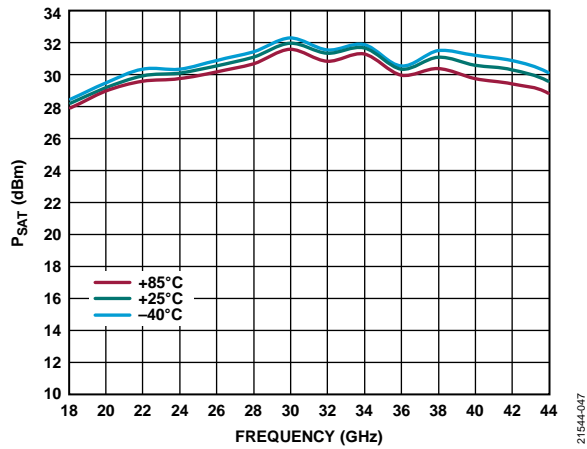

Figure 51. P<sub>SAT</sub> vs. Frequency for Various Temperatures

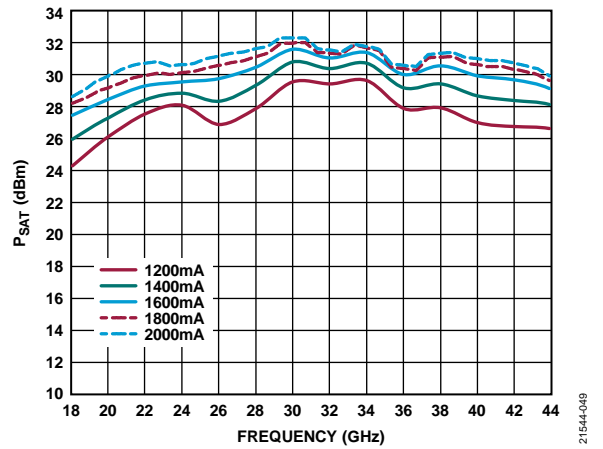

Figure 53. P<sub>SAT</sub> vs. Frequency for Various Drain Currents

## THEORY OF OPERATION

The simplified architecture of the ADPA7007 power amplifier is shown in Figure 54. The ADPA7007 is a cascaded, three-stage amplifier with a combined gain of 21.5 dB and a  $P_{SAT}$  value of 31.5 dBm.

The drain current is controlled by the voltage on the  $V_{GG1}$  and  $V_{GG2}$  pins. These pins must be connected together and driven by a negative voltage in the  $-1.5\text{ V}$  to  $0\text{ V}$  range (typical gate bias voltage for a quiescent drain current bias of 1400 mA is  $-0.685\text{ V}$ ). Simplified bias pin connections to the dedicated gain stages are shown in Figure 54.

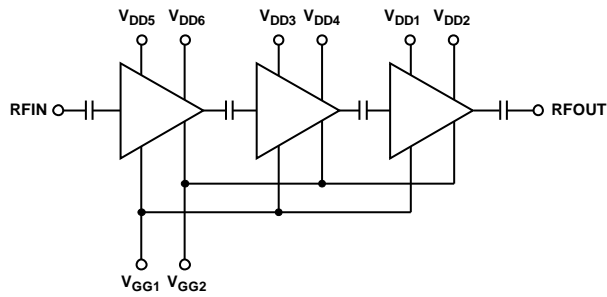

Figure 54. Simplified Architecture of ADPA7007

A portion of the RF output signal is directionally coupled to a diode for detection of the RF output power. When the diode is dc biased, the diode rectifies the RF power and makes the RF power available for measurement as a dc voltage at  $V_{DET}$ . To allow temperature compensation of  $V_{DET}$ , an identical and symmetrically located circuit (minus the coupled RF power) is available via  $V_{REF}$ . The difference of  $V_{REF} - V_{DET}$  provides a temperature compensated signal that is proportional to the RF output.

To obtain optimal performance from the ADPA7007 and avoid damaging the device, follow the recommended biasing sequences described in the Applications Information section.



## APPLICATIONS INFORMATION

Figure 55 shows the basic connections for operating the ADPA7007. All measurements for this device were taken using the typical application circuit shown in Figure 55.

Capacitive bypassing is required for all  $V_{GGx}$  and  $V_{DDx}$  pins.  $V_{GG1}$  and  $V_{GG2}$  are the gate bias pins, and  $V_{DD1}$  to  $V_{DD6}$  are the drain bias pins for the cascaded amplifier.

The power supply and gate voltage decoupling capacitors shown in Figure 55 represent the configuration that was used to characterize and qualify the device. There may be scopes to reduce the number of capacitors, but scopes vary from system to system. It is recommended to first remove or combine the largest capacitors that are farthest from the device. The following is the recommended bias sequence during power-up:

1. Connect the power supply ground to circuit ground (GND).
2. Set the gate bias voltages,  $V_{GG1}$  and  $V_{GG2}$ , to  $-1.5$  V.
3. Set all drain bias voltages ( $V_{DDx}$ ) to 5 V.
4. Increase the gate bias voltage to achieve the quiescent supply current and set  $I_{DQ} = 1400$  mA.
5. Apply the RF signal.

The following is the recommended bias sequence during power-down:

1. Turn off the RF signal.
2. Decrease the gate bias voltages,  $V_{GG1}$  and  $V_{GG2}$ , to  $-1.5$  V to achieve an  $I_{DQ} = 0$  mA (approximately).
3. Decrease all drain bias voltages to 0 V.
4. Increase the  $V_{GGx}$  gate bias voltage to 0 V.

The  $V_{DD} = 5$  V and  $I_{DQ} = 1400$  mA bias conditions are recommended to optimize overall performance when the gate voltage is being held at a fixed value (note that with the gate voltage held at a fixed value, the drain current,  $I_{DD}$ , increases as the RF input power level is increased, as shown in Figure 41). Unless otherwise noted, the data shown was taken using the recommended bias conditions. Operation of the ADPA7007 at different bias conditions can result in different performance. Biasing the ADPA7007 for higher quiescent drain current typically results in higher gain and output P1dB at the expense of increased power dissipation (see Table 8).

Table 8. Power Selection<sup>1,2</sup>

$I_{DQ}$ (mA)	Gain (dB)	Output P1dB (dBm)	Output IP3 (dBm)	$P_{DISS}$ (W)	$V_{GGx}$ (V)
1200	15.80	31.89	42.90	6	-0.73
1400	16.20	31.93	41.30	7	-0.68
1600	16.50	31.95	39.55	8	-0.63

<sup>1</sup> Data taken at the following nominal bias conditions:  $V_{DD} = 5$  V,  $T_A = 25^\circ\text{C}$ , frequency = 32 GHz.  
<sup>2</sup> Adjust  $V_{GG1}$  and  $V_{GG2}$  from  $-1.5$  V to 0 V to achieve the desired quiescent drain current,  $I_{DQ}$ .

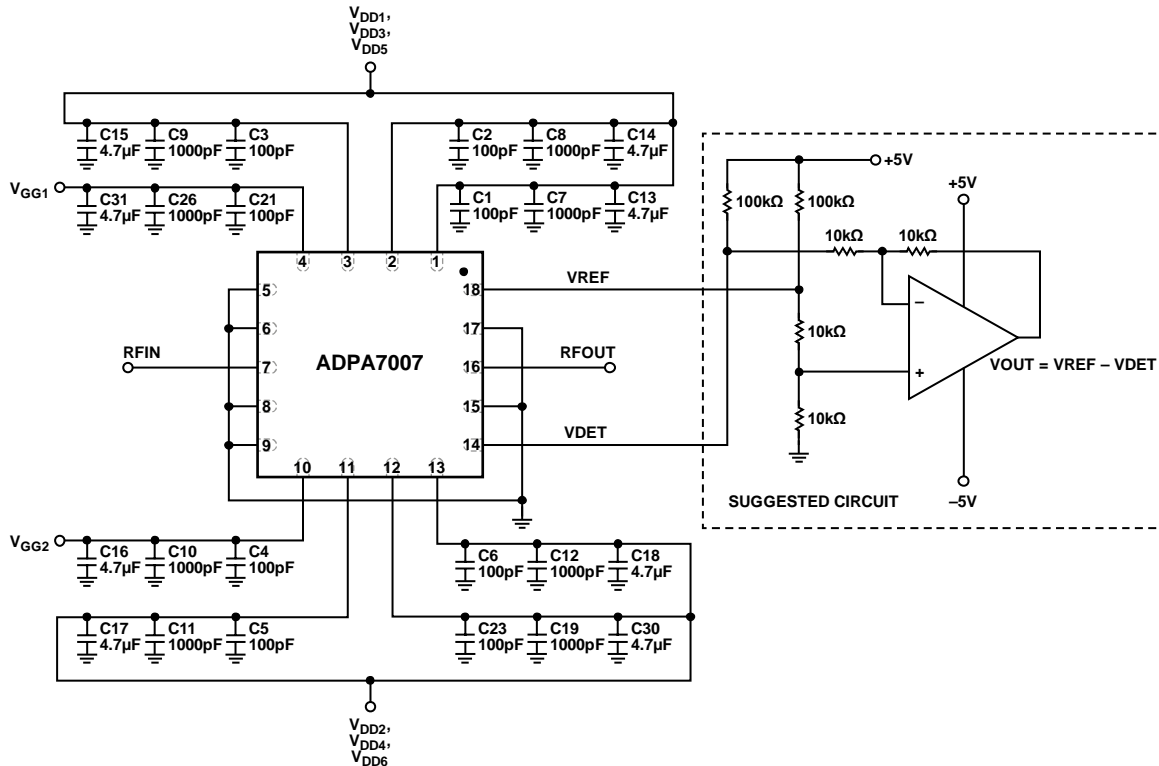

Figure 55. Typical Application Circuit

## BIASING ADPA7007 WITH THE HMC980LP4E

The HMC980LP4E is an active bias controller that measures and regulates drain current by automatically adjusting the gate voltage. The HMC980LP4E can control the biasing of RF amplifiers with drain voltages up to 16.5 V and currents up to 1.6 A. The controller provides constant drain current biasing over temperature and device to device variation, and properly sequences gate and drain voltages to ensure the safe operation of the amplifier.

The HMC980LP4E offers self protection in the event of a short circuit, as well as an internal charge pump that generates the negative voltage required on the gate of the ADPA7007. The HMC980LP4E also provides the option to use an external negative voltage source. The HMC980LP4E is also available in die form as the HMC980.

### APPLICATION CIRCUIT SETUP

Figure 56 shows a schematic of an application circuit using the two HMC980LP4E devices to control the ADPA7007. When using an external negative supply for VNEG, refer to the schematic in Figure 57.

Although the ADPA7007 is specified with a quiescent drain current of 1400 mA, the operational drain current,  $I_{DRAIN}$ , required to achieve the maximum output power from the ADPA7007 must be set closer to 1800 mA. The  $I_{DRAIN}$  current increases to approximately 1800 mA when the RF input power is 15 dBm, the approximate input compression point (see Figure 41). As a result, a target  $I_{DRAIN}$  of 1800 mA is chosen.

Two HMC980LP4E devices are needed to support current levels at 1800 mA because a single HMC980LP4E device can support a maximum current of 1600 mA. In the application circuit shown in Figure 56 and Figure 57, the ADPA7007 drain voltage and drain current are set by the following equations:

$$V_{DRAIN} = V_{DD} - I_{DRAIN} \times 0.85 \Omega \quad (1)$$

where:

$V_{DRAIN} = 5$  V, the drain voltage from Pin 17 and Pin 18 of the HMC980LP4E.

$V_{DD} = 5.765$  V, the supply voltage to the HMC980LP4E.

$I_{DRAIN} = 1800$  mA, the constant drain current from Pin 17 and Pin 18 on the HMC980LP4E.

$$R_{10} = \frac{150 \Omega}{I_{DRAIN}} \quad (2)$$

where:

$I_{DRAIN} = 900$  mA (for each HMC980LP4E, per the dual bias setup in Figure 56).

$R_{10} = 166.66 \Omega$ .

### LIMITING VGATE AND VNEG FOR ADPA7007 $V_{GGX}$ ABSOLUTE MAXIMUM RATING REQUIREMENT

When using the HMC980LP4E to control the ADPA7007, set the minimum voltages for the VNEG and VGATE pins of the HMC980LP4E to  $-1.5$  V to keep these voltages within the absolute maximum rating limits for the  $V_{GGX}$  pins of the ADPA7007. To set the minimum voltages, use the R15 and R16 resistors shown in Figure 56 and Figure 57. Refer to the [AN-1363 Application Note, Meeting Biasing Requirements of Externally Biased RF/Microwave Amplifiers with Active Bias Controllers](#), for more information and calculations for R15 and R16.

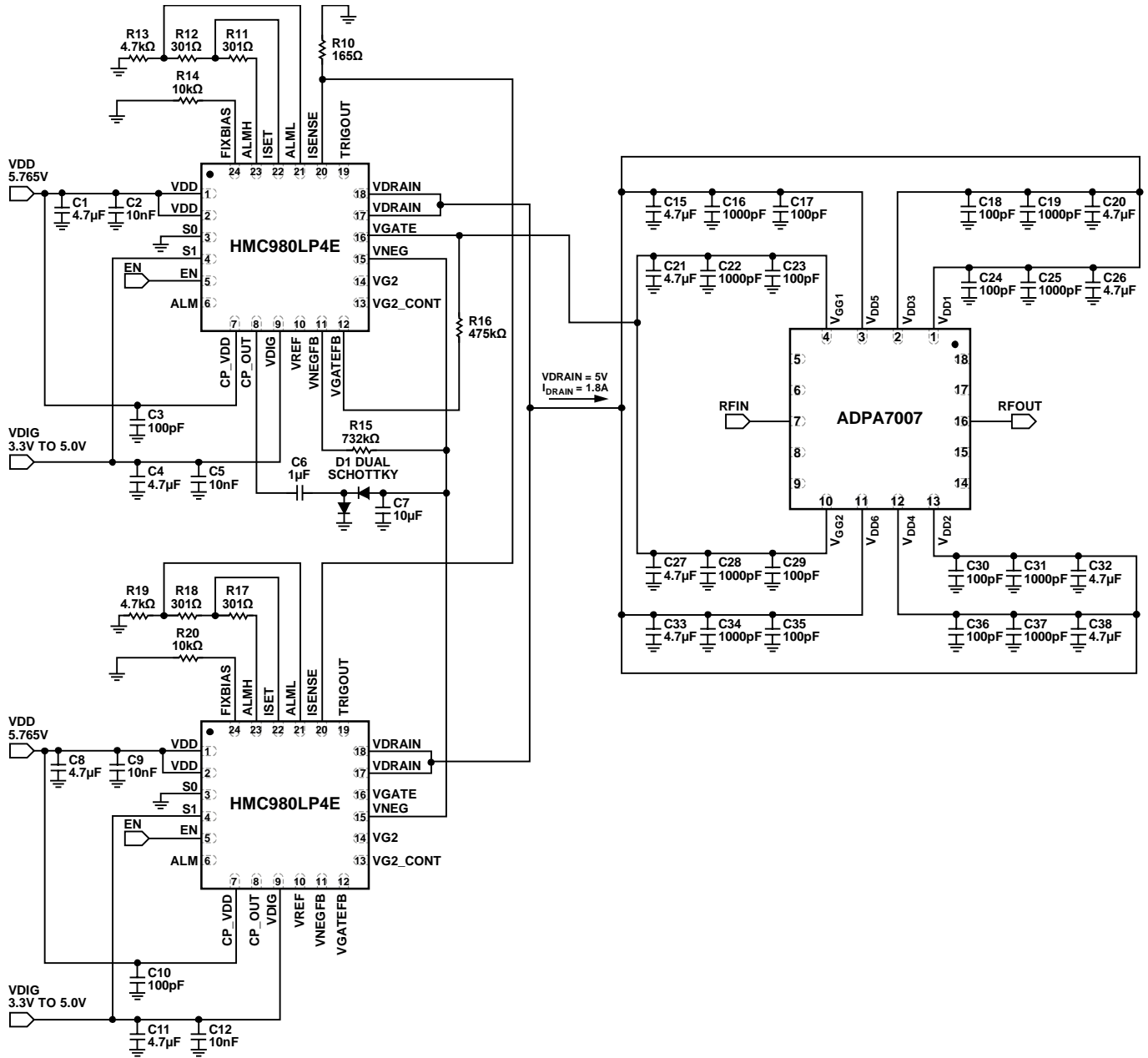

Figure 56. Application Circuit Using Dual HMC980LP4E with ADPA7007

21544-052

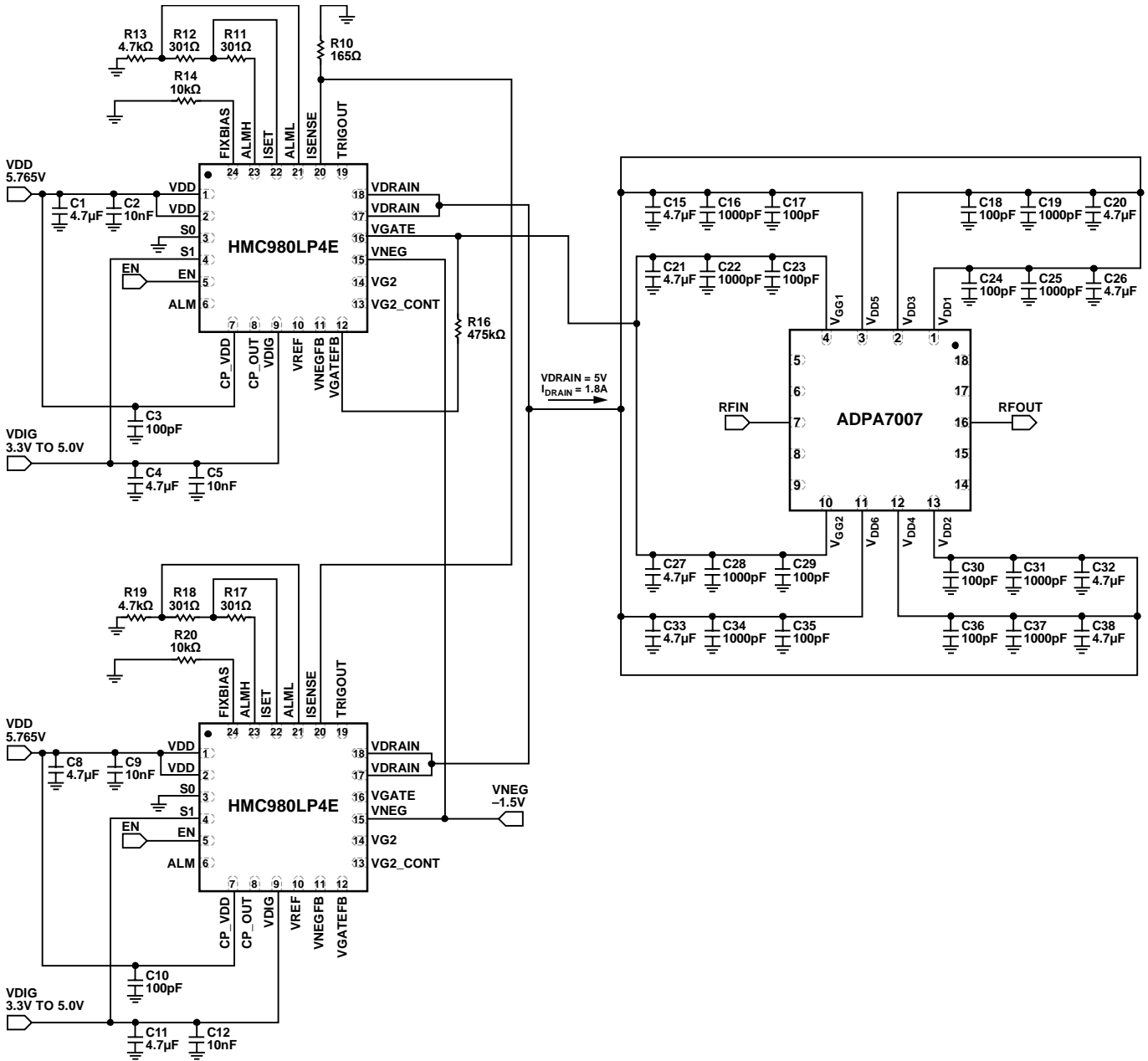

Figure 57. Application Circuit Using Dual HMC980LP4E with ADPA7007 and External Negative Voltage Source

21544-053

### HMC980LP4E BIAS SEQUENCE

The dc supply sequencing in the Power-Up Sequence section and the Power-Down Sequence section is required to prevent damage to the HMC980LP4E when using it to control the ADPA7007.

#### Power-Up Sequence

The power-up sequence is as follows:

1. Set VDIG (Pin 9) of both HMC980LP4E devices to 3.3 V.
2. Set the VDD pins of both HMC980LP4E devices to 5.765 V.
3. Set VNEG (Pin 15) of both HMC980LP4E devices to -1.5 V. This step is not needed if using an internally generated voltage.
4. Set EN (Pin 5) of both HMC980LP4E devices to 3.3 V (transitioning from 0 V to 3.3 V turns on VGATE and VDRAIN).

#### Power-Down Sequence

The power-down sequence is as follows:

1. Set EN (Pin 5 of both HMC980LP4E devices) to 0 V (transitioning from 3.3 V to 0 V turns off VDRAIN and VGATE).
2. Set VNEG (Pin 15 of both HMC980LP4E devices) to 0 V. This step is not needed if using an internally generated voltage.
3. Set the VDD pins of both HMC980LP4E devices to 0 V.
4. Set VDIG (Pin 9 of both HMC980LP4E devices) to 0 V.

When the HMC980LP4E bias control circuit is set up, toggle the bias to the ADPA7007 on or off by applying 3.3 V or 0 V, respectively, to the EN pin of the HMC980LP4E. At EN = 3.3 V, the VGATE pin of the HMC980LP4E drops to -1.5 V and the VDRAIN pin of the HMC980LP4E turns on at 5 V. VGATE then rises until  $I_{DRAIN} = 1800$  mA, and the closed control loop regulates  $I_{DRAIN}$  at 1800 mA. When EN = 0 V, VGATE is set to -1.5 V, and VDRAIN is set to 0 V (see Figure 58 and Figure 59).

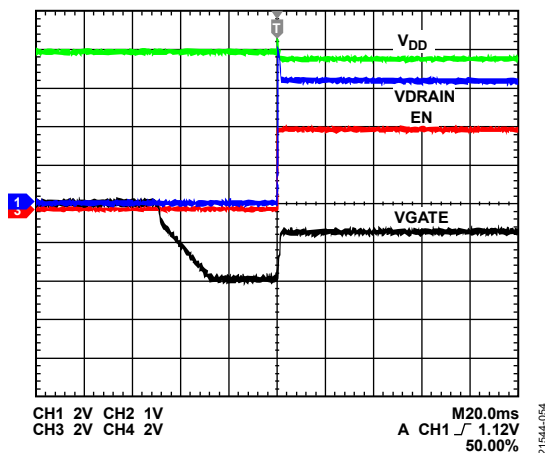

Figure 58. Turn On HMC980LP4E Outputs to ADPA7007

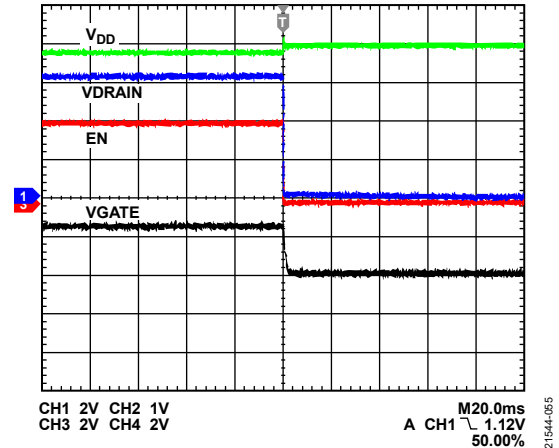

Figure 59. Turn Off HMC980LP4E Outputs to ADPA7007

### CONSTANT DRAIN CURRENT BIASING vs. CONSTANT GATE VOLTAGE BIASING

The HMC980LP4E uses a feedback loop to continuously adjust VGATE to maintain a constant drain current over dc supply variation, temperature, RF input/output level, and device to device variation. Constant drain current bias is the preferred method for reducing time in calibration procedures and for maintaining consistent performance over time.

In comparison to a constant gate voltage bias, where the current increases when RF power is applied, a constant drain current has a slightly lower output P1dB. This output P1dB is shown in Figure 63, where the RF performance is slightly lower than constant gate bias voltage operation due to a lower drain current at high input power (see Figure 60) as the HMC980LP4E reaches 1 dB compression.

The output P1dB performance for constant drain current bias can be increased toward constant gate voltage bias performance by increasing the set current toward the  $I_{DD}$  value it reaches under RF drive in the constant gate voltage bias condition (see Figure 63).

The limit of increasing drain current under the constant current operation is set by the thermal limitations found in Table 4 with the maximum power dissipation specification. As the  $I_{DD}$  increase continues, the actual output P1dB does not continue to increase indefinitely but the power dissipation increases linearly. Therefore, take the trade-off between the power dissipation and output P1dB performance into consideration when using constant drain current biasing.

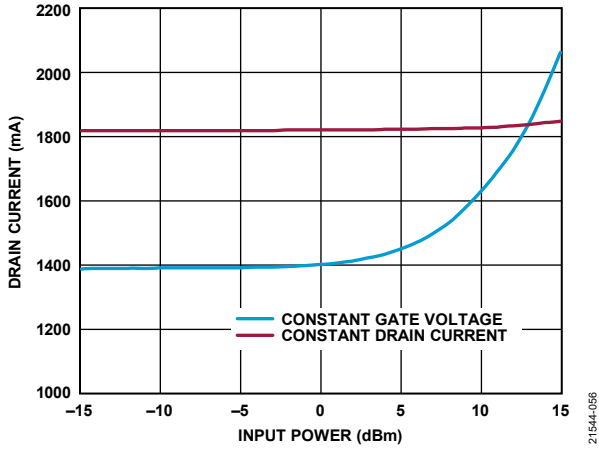

Figure 60. Drain Current vs. Input Power,  $V_{DD} = 5\text{ V}$ , Frequency = 32 GHz, Constant Drain Current Bias ( $I_{DRAIN}$  Setpoint = 1800 mA) and Constant Gate Voltage Bias ( $V_{GGX} \approx -0.68\text{ V}$ )

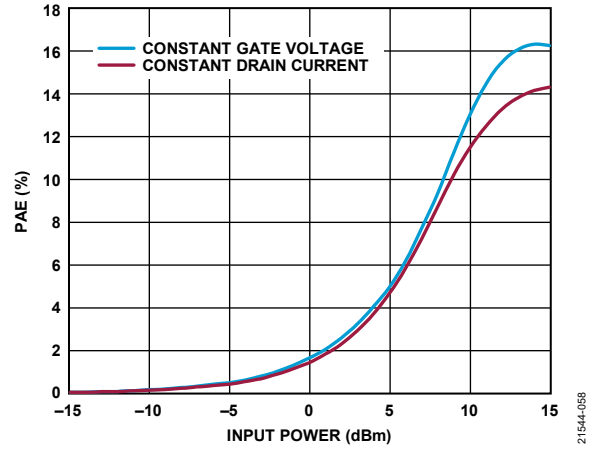

Figure 62. PAE vs. Input Power,  $V_{DD} = 5\text{ V}$ , Frequency = 32 GHz, Constant Drain Current Bias ( $I_{DRAIN}$  Setpoint = 1800 mA) and Constant Gate Voltage Bias ( $V_{GGX} \approx -0.68\text{ V}$ )

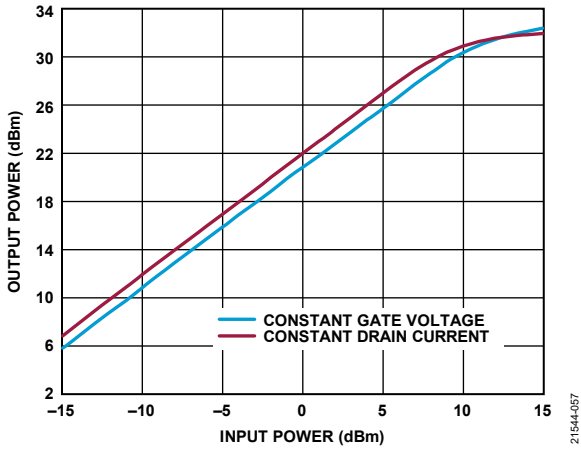

Figure 61. Output Power vs. Input Power,  $V_{DD} = 5\text{ V}$ , Frequency = 32 GHz, Constant Drain Current Bias ( $I_{DRAIN}$  Setpoint = 1800 mA) and Constant Gate Voltage Bias ( $V_{GGX} \approx -0.68\text{ V}$ )

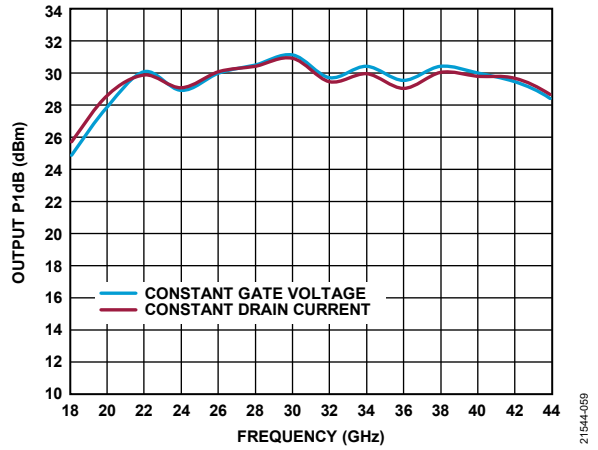

Figure 63. Output P1dB vs. Frequency,  $V_{DD} = 5\text{ V}$ , Constant Drain Current Bias ( $I_{DRAIN}$  Setpoint = 1800 mA) and Constant Gate Voltage Bias ( $V_{GGX} \approx -0.68\text{ V}$ )

# OUTLINE DIMENSIONS

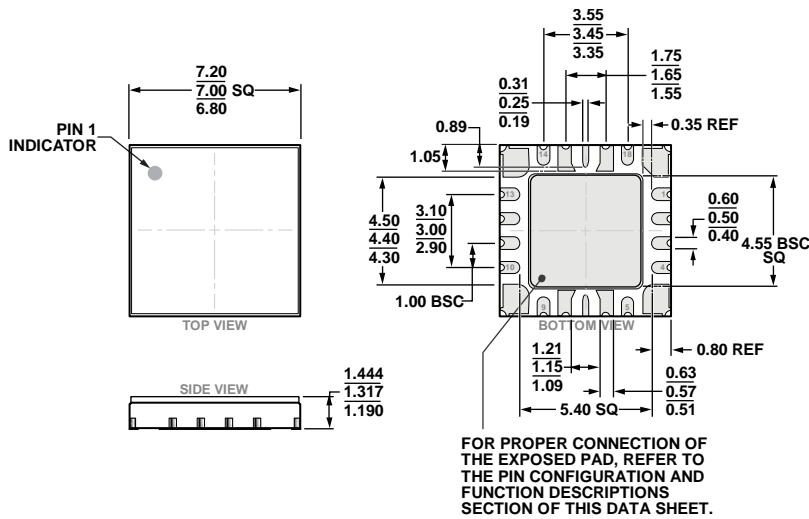

Figure 64. 18-Terminal Ceramic Leadless Chip Carrier with Heat Sink [LCC\_HS] (EH-18-1)  
Dimensions shown in millimeters

## ORDERING GUIDE

Model <sup>1</sup>	Temperature Range	MSL Rating <sup>2</sup>	Package Description	Package Option
ADPA7007AEHZ	-40°C to +85°C	MSL3	18-Terminal Ceramic Leadless Chip Carrier with Heat Sink [LCC_HS]	EH-18-1
ADPA7007AEHZ-R7	-40°C to +85°C	MSL3	18-Terminal Ceramic Leadless Chip Carrier with Heat Sink [LCC_HS]	EH-18-1
ADPA7007-EVALZ				

<sup>1</sup> Z = RoHS Compliant Part.

<sup>2</sup> See the Absolute Maximum Ratings section for additional information.

## X-ON Electronics

Largest Supplier of Electrical and Electronic Components

*Click to view similar products for [RF Amplifier](#) category:*

*Click to view products by [Analog Devices](#) manufacturer:*

Other Similar products are found below :

[A82-1](#) [BGA622H6820XTSA1](#) [BGA 728L7 E6327](#) [BGB719N7ESDE6327XTMA1](#) [HMC397-SX](#) [HMC405](#) [HMC561-SX](#) [HMC8120-SX](#)  
[HMC8121-SX](#) [HMC-ALH382-SX](#) [HMC-ALH476-SX](#) [SE2433T-R](#) [SMA3101-TL-E](#) [SMA39](#) [A66-1](#) [A66-3](#) [A67-1](#) [A81-2](#) [LX5535LQ](#)  
[LX5540LL](#) [MAAM02350](#) [HMC3653LP3BETR](#) [HMC549MS8GETR](#) [HMC-ALH435-SX](#) [SMA101](#) [SMA32](#) [SMA411](#) [SMA531](#)  
[SST12LP19E-QX6E](#) [WPM0510A](#) [HMC5929LS6TR](#) [HMC5879LS7TR](#) [HMC1087F10](#) [HMC1086](#) [HMC1016](#) [SMA1212](#) [MAX2689EWS+T](#)  
[MAAMSS0041TR](#) [MAAM37000-A1G](#) [LTC6430AIUF-15#PBF](#) [SMA70-2](#) [SMA4011](#) [A231](#) [HMC-AUH232](#) [LX5511LQ](#) [LX5511LQ-TR](#)  
[HMC7441-SX](#) [HMC-ALH310](#) [XD1001-BD-000V](#) [A4011](#)