

### FEATURES

- Ultracompact SC70 and SOT-23-3 packages
- Temperature coefficient: 40 ppm/°C (maximum)
- 2× the temperature coefficient improvement over the LM4040
- Pin compatible with the LM4040/LM4050
- Initial accuracy: ±0.2%
- Low output voltage noise: 18 μV p-p @ 2.5 V output
- No external capacitor required
- Operating current range: 50 μA to 15 mA
- Industrial temperature range: -40°C to +85°C

### APPLICATIONS

- Portable, battery-powered equipment
- Automotive
- Power supplies
- Data acquisition systems
- Instrumentation and process control
- Energy measurement

Table 1. Selection Guide

Part	Voltage (V)	Initial Accuracy (%)	Temperature Coefficient (ppm/°C)
ADR525A	2.5	±0.4	70
ADR525B	2.5	±0.2	40
ADR530A	3.0	±0.4	70
ADR530B	3.0	±0.2	40
ADR550A	5.0	±0.4	70
ADR550B	5.0	±0.2	40

### PIN CONFIGURATION

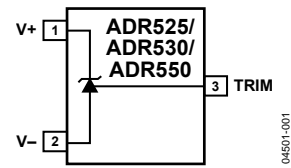

Figure 1. 3-Lead SC70 (KS) and 3-Lead SOT-23-3 (RT)

### GENERAL DESCRIPTION

Designed for space-critical applications, the ADR525/ADR530/ADR550 are high precision shunt voltage references, housed in ultrasmall SC70 and SOT-23-3 packages. These references feature low temperature drift of 40 ppm/°C, an initial accuracy of better than ±0.2%, and ultralow output noise of 18 μV p-p.

Available in output voltages of 2.5 V, 3.0 V, and 5.0 V, the advanced design of the ADR525/ADR530/ADR550 eliminates the need for compensation by an external capacitor, yet the references are stable with any capacitive load. The minimum operating current increases from a mere 50 μA to a maximum of 15 mA. This low operating current and ease of use make these references ideally suited for handheld, battery-powered applications.

A trim terminal is available on the ADR525/ADR530/ADR550 to allow adjustment of the output voltage over a ±0.5% range, without affecting the temperature coefficient of the device. This feature provides users with the flexibility to trim out small system errors.

For better initial accuracy and wider temperature range, see the [ADR5040/ADR5041/ADR5043/ADR5044/ADR5045](#) family at [www.analog.com](http://www.analog.com).

#### Rev. F

Information furnished by Analog Devices is believed to be accurate and reliable. However, no responsibility is assumed by Analog Devices for its use, nor for any infringements of patents or other rights of third parties that may result from its use. Specifications subject to change without notice. No license is granted by implication or otherwise under any patent or patent rights of Analog Devices. Trademarks and registered trademarks are the property of their respective owners.

## TABLE OF CONTENTS

Features .....	1	Thermal Resistance .....	5
Applications .....	1	ESD Caution .....	5
Pin Configuration .....	1	Parameter Definitions .....	6
General Description .....	1	Temperature Coefficient .....	6
Revision History .....	2	Thermal Hysteresis .....	6
Specifications .....	3	Typical Performance Characteristics .....	7
ADR525 Electrical Characteristics .....	3	Theory of Operation .....	9
ADR530 Electrical Characteristics .....	3	Applications .....	9
ADR550 Electrical Characteristics .....	4	Outline Dimensions .....	11
Absolute Maximum Ratings .....	5	Ordering Guide .....	12

## REVISION HISTORY

### 8/10—Rev. E to Rev. F

Deleted ADR520 and ADR540 .....	Universal
Changes to Table 1, Figure 1, and General Description Section .....	1
Deleted ADR520 Electrical Characteristics Section .....	3
Deleted Table 2; Renumbered Sequentially .....	3
Deleted ADR540 Electrical Characteristics Section and Table 5 .....	4
Changes to Figure 2 and Figure 7 .....	7
Deleted Figure 3; Renumbered Sequentially .....	8
Changes to Figure 9 and Figure 10 .....	8
Deleted Figure 8, Figure 9, and Figure 12 .....	9
Changes to Figure 20 .....	10

### 6/08—Rev. D to Rev. E

Changes to Table 3 .....	3
Changes to Table 4 and Table 5 .....	4
Changes to Table 6 .....	5
Changes to Figure 4 .....	8
Changes to Applications Section .....	11

### 12/07—Rev. C to Rev. D

Changes to Figure 3 and Figure 5 .....	8
Changes to Figure 15, Figure 16, and Figure 17 Captions .....	10
Changes to Figure 23 .....	12
Updated Outline Dimensions .....	13

### 8/07—Rev. B to Rev. C

Changes to Figure 21 .....	11
Updated Outline Dimensions .....	13
Changes to Ordering Guide .....	14

### 1/06—Rev. A to Rev. B

Updated Formatting .....	Universal
Changes to Features Section .....	1
Changes to General Description Section .....	1
Updated Outline Dimensions .....	13
Changes to Ordering Guide .....	14

### 12/03—Data Sheet Changed from Rev. 0 to Rev. A

Updated Outline Dimensions .....	13
Change to Ordering Guide .....	14

### 11/03—Revision 0: Initial Version

## SPECIFICATIONS

### ADR525 ELECTRICAL CHARACTERISTICS

$I_{IN} = 50 \mu\text{A}$  to 15 mA,  $T_A = 25^\circ\text{C}$ , unless otherwise noted.

Table 2.

Parameter	Symbol	Conditions	Min	Typ	Max	Unit
Output Voltage	$V_{OUT}$					
Grade A			2.490	2.500	2.510	V
Grade B			2.495	2.500	2.505	V
Initial Accuracy	$V_{OERR}$					
Grade A		$\pm 0.4\%$	-10		+10	mV
Grade B		$\pm 0.2\%$	-5		+5	mV
Temperature Coefficient <sup>1</sup>	$TCV_O$	$-40^\circ\text{C} < T_A < +85^\circ\text{C}$				
Grade A				25	70	ppm/ $^\circ\text{C}$
Grade B				15	40	ppm/ $^\circ\text{C}$
Output Voltage Change vs. $I_{IN}$	$\Delta V_R$	$I_{IN} = 0.1 \text{ mA to } 15 \text{ mA}$ $-40^\circ\text{C} < T_A < +85^\circ\text{C}$			1	mV
		$I_{IN} = 1 \text{ mA to } 15 \text{ mA}, -40^\circ\text{C} < T_A < +85^\circ\text{C}$			4	mV
					2	mV
Dynamic Output Impedance	$(\Delta V_R / \Delta I_R)$	$I_{IN} = 0.1 \text{ mA to } 15 \text{ mA}$			0.2	$\Omega$
Minimum Operating Current	$I_{IN}$	$-40^\circ\text{C} < T_A < +85^\circ\text{C}$	50			$\mu\text{A}$
Voltage Noise	$e_{N \text{ p-p}}$	0.1 Hz to 10 Hz		18		$\mu\text{V p-p}$
Turn-On Settling Time	$t_R$			2		$\mu\text{s}$
Output Voltage Hysteresis	$\Delta V_{OUT\_HYS}$	$I_{IN} = 1 \text{ mA}$		40		ppm

<sup>1</sup> Guaranteed by design, but not production tested.

### ADR530 ELECTRICAL CHARACTERISTICS

$I_{IN} = 50 \mu\text{A}$  to 15 mA,  $T_A = 25^\circ\text{C}$ , unless otherwise noted.

Table 3.

Parameter	Symbol	Conditions	Min	Typ	Max	Unit
Output Voltage	$V_{OUT}$					
Grade A			2.988	3.000	3.012	V
Grade B			2.994	3.000	3.006	V
Initial Accuracy	$V_{OERR}$					
Grade A		$\pm 0.4\%$	-12		+12	mV
Grade B		$\pm 0.2\%$	-6		+6	mV
Temperature Coefficient <sup>1</sup>	$TCV_O$	$-40^\circ\text{C} < T_A < +85^\circ\text{C}$				
Grade A				25	70	ppm/ $^\circ\text{C}$
Grade B				15	40	ppm/ $^\circ\text{C}$
Output Voltage Change vs. $I_{IN}$	$\Delta V_R$	$I_{IN} = 0.1 \text{ mA to } 15 \text{ mA}$ $-40^\circ\text{C} < T_A < +85^\circ\text{C}$			1	mV
		$I_{IN} = 1 \text{ mA to } 15 \text{ mA}, -40^\circ\text{C} < T_A < +85^\circ\text{C}$			4	mV
					2	mV
Dynamic Output Impedance	$(\Delta V_R / \Delta I_R)$	$I_{IN} = 0.1 \text{ mA to } 15 \text{ mA}$			0.2	$\Omega$
Minimum Operating Current	$I_{IN}$	$-40^\circ\text{C} < T_A < +85^\circ\text{C}$	50			$\mu\text{A}$
Voltage Noise	$e_{N \text{ p-p}}$	0.1 Hz to 10 Hz		22		$\mu\text{V p-p}$
Turn-On Settling Time	$t_R$			2		$\mu\text{s}$
Output Voltage Hysteresis	$\Delta V_{OUT\_HYS}$	$I_{IN} = 1 \text{ mA}$		40		ppm

<sup>1</sup> Guaranteed by design, but not production tested.

# ADR525/ADR530/ADR550

## ADR550 ELECTRICAL CHARACTERISTICS

$I_{IN} = 50 \mu\text{A}$  to 15 mA,  $T_A = 25^\circ\text{C}$ , unless otherwise noted.

Table 4.

Parameter	Symbol	Conditions	Min	Typ	Max	Unit
Output Voltage	$V_{OUT}$					
Grade A			4.980	5.000	5.020	V
Grade B			4.990	5.000	5.010	V
Initial Accuracy	$V_{OERR}$					
Grade A		$\pm 0.4\%$	-20		+20	mV
Grade B		$\pm 0.2\%$	-10		+10	mV
Temperature Coefficient <sup>1</sup>	$TCV_O$	$-40^\circ\text{C} < T_A < +85^\circ\text{C}$				
Grade A				25	70	ppm/ $^\circ\text{C}$
Grade B				15	40	ppm/ $^\circ\text{C}$
Output Voltage Change vs. $I_{IN}$	$\Delta V_R$	$I_{IN} = 0.1 \text{ mA to } 15 \text{ mA}$ $-40^\circ\text{C} < T_A < +85^\circ\text{C}$			1	mV
		$I_{IN} = 1 \text{ mA to } 15 \text{ mA}, -40^\circ\text{C} < T_A < +85^\circ\text{C}$			5	mV
					2	mV
Dynamic Output Impedance	$(\Delta V_R / \Delta I_R)$	$I_{IN} = 0.1 \text{ mA to } 15 \text{ mA}$			0.2	$\Omega$
Minimum Operating Current	$I_{IN}$	$-40^\circ\text{C} < T_A < +85^\circ\text{C}$	50			$\mu\text{A}$
Voltage Noise	$e_{N \text{ p-p}}$	0.1 Hz to 10 Hz		38		$\mu\text{V p-p}$
Turn-On Settling Time	$t_R$			2		$\mu\text{s}$
Output Voltage Hysteresis	$\Delta V_{OUT\_HYS}$	$I_{IN} = 1 \text{ mA}$		40		ppm

<sup>1</sup> Guaranteed by design, but not production tested.

## ABSOLUTE MAXIMUM RATINGS

Ratings apply at 25°C, unless otherwise noted.

Table 5.

Parameter	Rating
Reverse Current	25 mA
Forward Current	20 mA
Storage Temperature Range	−65°C to +150°C
Industrial Temperature Range	−40°C to +85°C
Junction Temperature Range	−65°C to +150°C
Lead Temperature (Soldering, 60 sec)	300°C

Stresses above those listed under Absolute Maximum Ratings may cause permanent damage to the device. This is a stress rating only; functional operation of the device at these or any other conditions above those indicated in the operational section of this specification is not implied. Exposure to absolute maximum rating conditions for extended periods may affect device reliability.

## THERMAL RESISTANCE

Table 6.

Package Type	$\theta_{JA}^1$	$\theta_{JC}$	Unit
3-Lead SC70 (KS)	580.5	177.4	°C/W
3-Lead SOT-23-3 (RT)	270	102	°C/W

<sup>1</sup>  $\theta_{JA}$  is specified for worst-case conditions, such as for devices soldered on circuit boards for surface-mount packages.

## ESD CAUTION



**ESD (electrostatic discharge) sensitive device.** Charged devices and circuit boards can discharge without detection. Although this product features patented or proprietary protection circuitry, damage may occur on devices subjected to high energy ESD. Therefore, proper ESD precautions should be taken to avoid performance degradation or loss of functionality.

## PARAMETER DEFINITIONS

### TEMPERATURE COEFFICIENT

Temperature coefficient is defined as the change in output voltage with respect to operating temperature changes and is normalized by the output voltage at 25°C. This parameter is expressed in ppm/°C and is determined by the following equation:

$$TCV_o \left[ \frac{\text{ppm}}{^\circ\text{C}} \right] = \frac{V_{OUT}(T_2) - V_{OUT}(T_1)}{V_{OUT}(25^\circ\text{C}) \times (T_2 - T_1)} \times 10^6 \quad (1)$$

where:

$V_{OUT}(T_2)$  =  $V_{OUT}$  at Temperature 2.

$V_{OUT}(T_1)$  =  $V_{OUT}$  at Temperature 1.

$V_{OUT}(25^\circ\text{C})$  =  $V_{OUT}$  at 25°C.

### THERMAL HYSTERESIS

Thermal hysteresis is defined as the change in output voltage after the device is cycled through temperatures ranging from +25°C to -40°C, then to +85°C, and back to +25°C. The following equation expresses a typical value from a sample of parts put through such a cycle:

$$V_{OUT\_HYS} = V_{OUT}(25^\circ\text{C}) - V_{OUT\_END}$$
$$V_{OUT\_HYS}[\text{ppm}] = \frac{V_{OUT}(25^\circ\text{C}) - V_{OUT\_END}}{V_{OUT}(25^\circ\text{C})} \times 10^6 \quad (2)$$

where:

$V_{OUT}(25^\circ\text{C})$  =  $V_{OUT}$  at 25°C.

$V_{OUT\_END}$  =  $V_{OUT}$  at 25°C after a temperature cycle from +25°C to -40°C, then to +85°C, and back to +25°C.

## TYPICAL PERFORMANCE CHARACTERISTICS

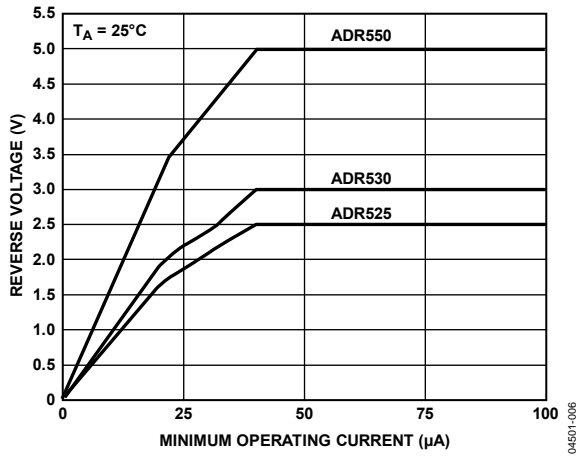

Figure 2. Reverse Characteristics and Minimum Operating Current

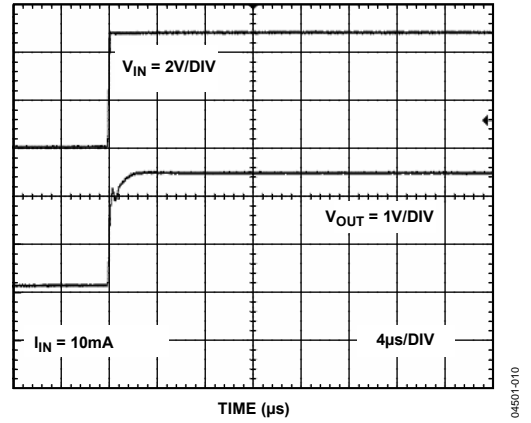

Figure 5. ADR525 Turn-On Response

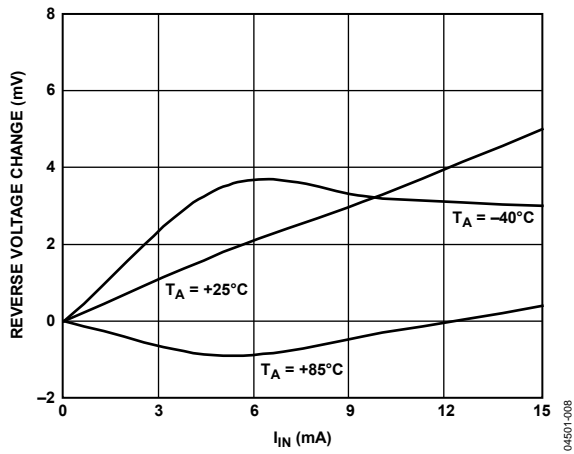

Figure 3. ADR525 Reverse Voltage vs. Operating Current

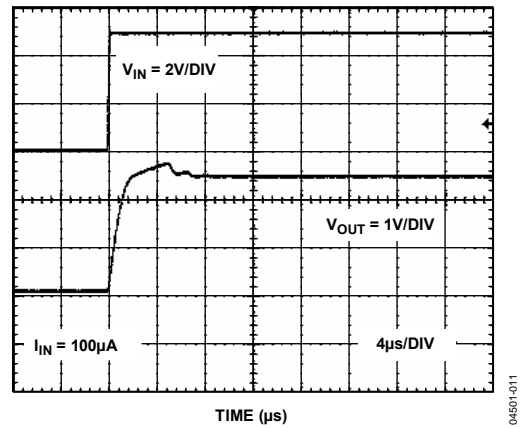

Figure 6. ADR525 Turn-On Response

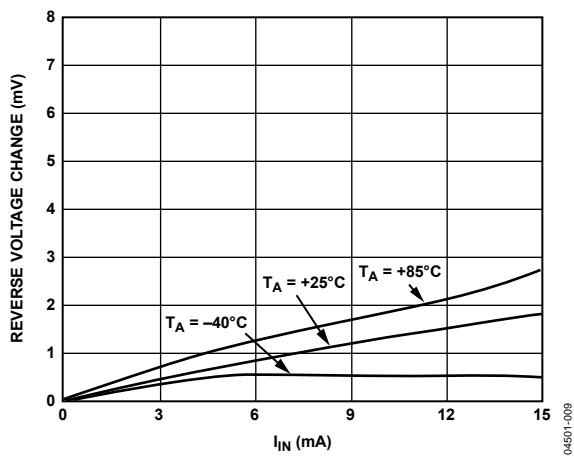

Figure 4. ADR550 Reverse Voltage vs. Operating Current

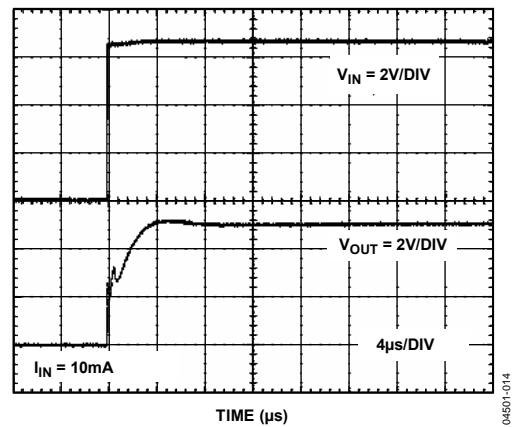

Figure 7. ADR550 Turn-On Response

# ADR525/ADR530/ADR550

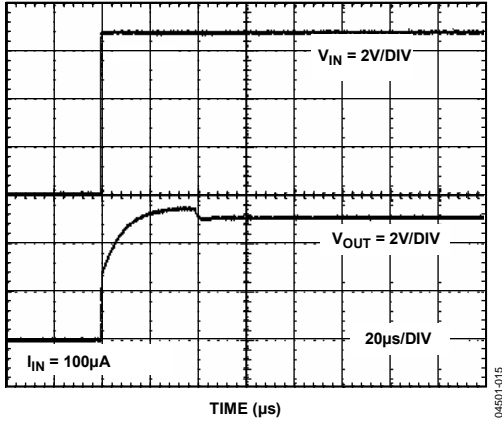

Figure 8. ADR550 Turn-On Response

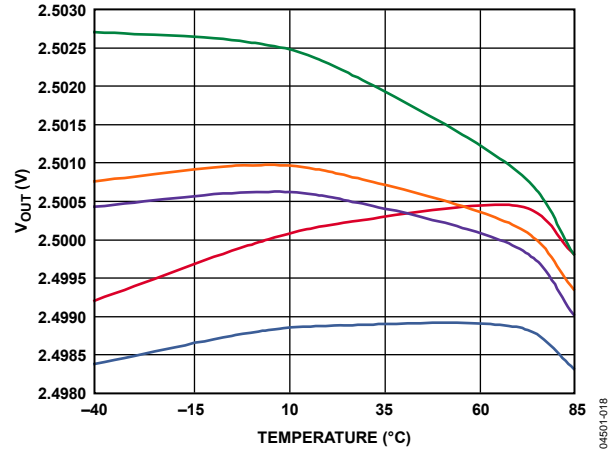

Figure 11. Data for Five Parts of ADR525  $V_{OUT}$  over Temperature

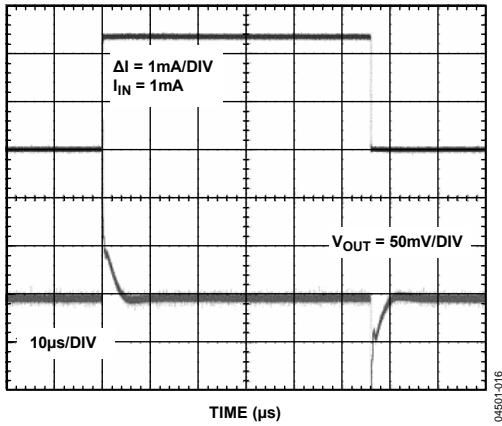

Figure 9. ADR525 Load Transient Response

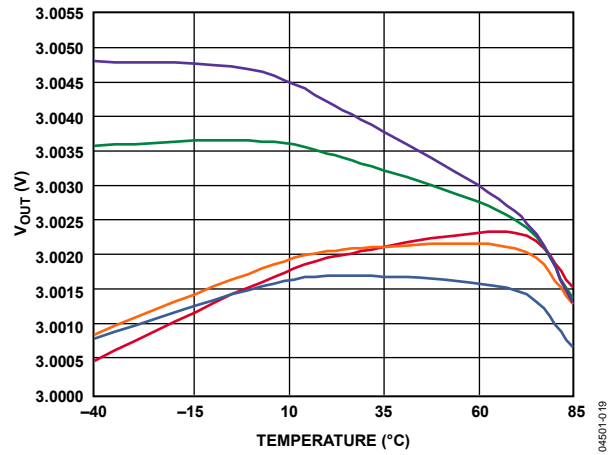

Figure 12. Data for Five Parts of ADR530  $V_{OUT}$  over Temperature

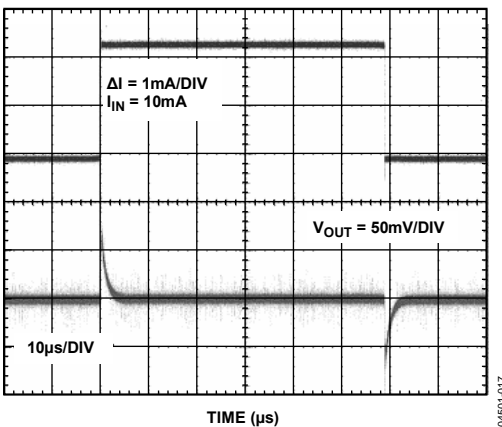

Figure 10. ADR550 Load Transient Response

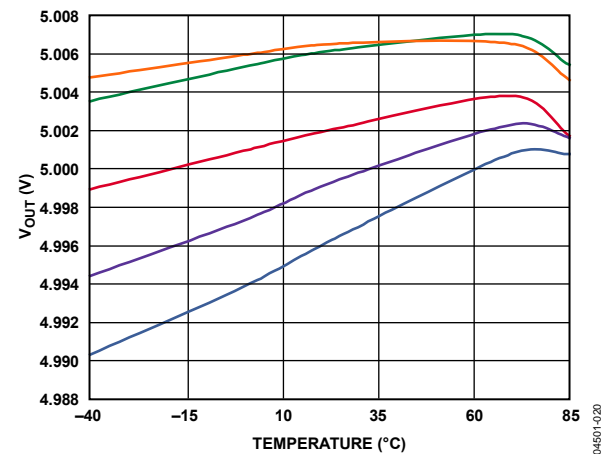

Figure 13. Data for Five Parts of ADR550  $V_{OUT}$  over Temperature



## THEORY OF OPERATION

The ADR525/ADR530/ADR550 use the band gap concept to produce a stable, low temperature coefficient voltage reference suitable for high accuracy data acquisition components and systems. The devices use the physical nature of a silicon transistor base-emitter voltage ( $V_{BE}$ ) in the forward-biased operating region. All such transistors have approximately a  $-2 \text{ mV}/^\circ\text{C}$  temperature coefficient (TC), making them unsuitable for direct use as low temperature coefficient references. Extrapolation of the temperature characteristics of any one of these devices to absolute zero (with the collector current proportional to the absolute temperature), however, reveals that its  $V_{BE}$  approaches approximately the silicon band gap voltage. Thus, if a voltage develops with an opposing temperature coefficient to sum the  $V_{BE}$ , a zero temperature coefficient reference results. The ADR525/ADR530/ADR550 circuit shown in Figure 14 provides such a compensating voltage ( $V_1$ ) by driving two transistors at different current densities and amplifying the resultant  $V_{BE}$  difference ( $\Delta V_{BE}$ , which has a positive temperature coefficient). The sum of  $V_{BE}$  and  $V_1$  provides a stable voltage reference over temperature.

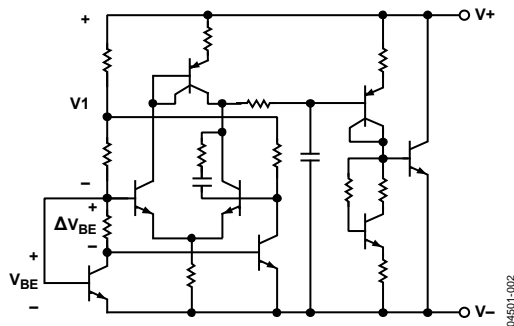

Figure 14. Circuit Schematic

## APPLICATIONS

The ADR525/ADR530/ADR550 are a series of precision shunt voltage references. They are designed to operate without an external capacitor between the positive and negative terminals. If a bypass capacitor is used to filter the supply, the references remain stable.

All shunt voltage references require an external bias resistor ( $R_{BIAS}$ ) between the supply voltage and the reference (see Figure 15).  $R_{BIAS}$  sets the current that flows through the load ( $I_L$ ) and the reference ( $I_{IN}$ ). Because the load and the supply voltage can vary,  $R_{BIAS}$  needs to be chosen based on the following considerations:

- $R_{BIAS}$  must be small enough to supply the minimum  $I_{IN}$  current to the ADR525/ADR530/ADR550, even when the supply voltage is at its minimum value and the load current is at its maximum value.
- $R_{BIAS}$  must be large enough so that  $I_{IN}$  does not exceed 15 mA when the supply voltage is at its maximum value and the load current is at its minimum value.

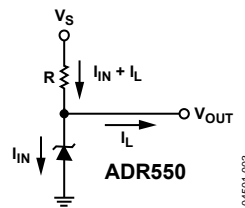

Figure 15. Shunt Reference

Given these conditions,  $R_{BIAS}$  is determined by the supply voltage ( $V_S$ ), the load and operating currents ( $I_L$  and  $I_{IN}$ ) of the ADR525/ADR530/ADR550, and the output voltage ( $V_{OUT}$ ) of the ADR525/ADR530/ADR550.

$$R_{BIAS} = \frac{V_S - V_{OUT}}{I_L + I_{IN}} \quad (3)$$

## Precision Negative Voltage Reference

The ADR525/ADR530/ADR550 are suitable for applications where a precise negative voltage is desired. Figure 16 shows the ADR525 configured to provide a negative output.

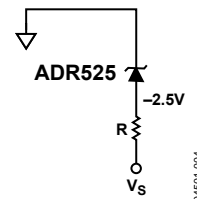

Figure 16. Negative Precision Reference Configuration

## Output Voltage Trim

The trim terminal of the ADR525/ADR530/ADR550 can be used to adjust the output voltage over a range of  $\pm 0.5\%$ . This allows systems designers to trim small system errors by setting the reference to a voltage other than the preset output voltage. An external mechanical or electrical potentiometer can be used for this adjustment. Figure 17 illustrates how the output voltage can be trimmed using the AD5273, an Analog Devices, Inc., 10 k $\Omega$  potentiometer.

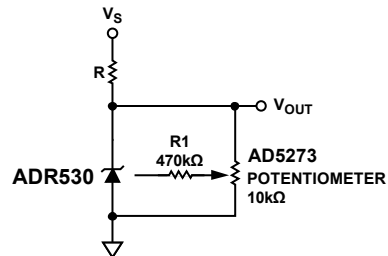

Figure 17. Output Voltage Trim

# ADR525/ADR530/ADR550

## Stacking the ADR525/ADR530/ADR550 for User-Definable Outputs

Multiple ADR525/ADR530/ADR550 parts can be stacked to allow the user to obtain a desired higher voltage. Figure 18 shows three ADR550s configured to give 15 V. The bias resistor,  $R_{BIAS}$ , is chosen using Equation 3; note that the same bias current flows through all the shunt references in series. Figure 19 shows three ADR550s stacked to give  $-15$  V.  $R_{BIAS}$  is calculated in the same manner as for Figure 18. Parts of different voltages can also be added together. For example, an ADR525 and an ADR550 can be added together to give an output of  $+7.5$  V or  $-7.5$  V, as desired. Note, however, that the initial accuracy error is now the sum of the errors of all the stacked parts, as are the temperature coefficients and output voltage change vs. input current.

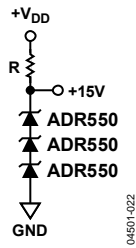

Figure 18. +15 V Output with Stacked ADR550s

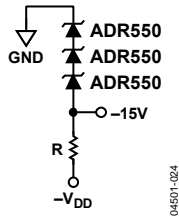

Figure 19.  $-15$  V Output with Stacked ADR550s

## Adjustable Precision Voltage Source

The ADR525/ADR530/ADR550, combined with a precision low input bias op amp, such as the AD8610, can be used to output a precise adjustable voltage. Figure 20 illustrates the implementation of this application using the ADR525/ADR530/ADR550. The output of the op amp,  $V_{OUT}$ , is determined by the gain of the circuit, which is completely dependent on the resistors,  $R_1$  and  $R_2$ .

$$V_{OUT} = V_{REF} (1 + R_2/R_1)$$

An additional capacitor,  $C_1$ , in parallel with  $R_2$ , can be added to filter out high frequency noise. The value of  $C_1$  is dependent on the value of  $R_2$ .

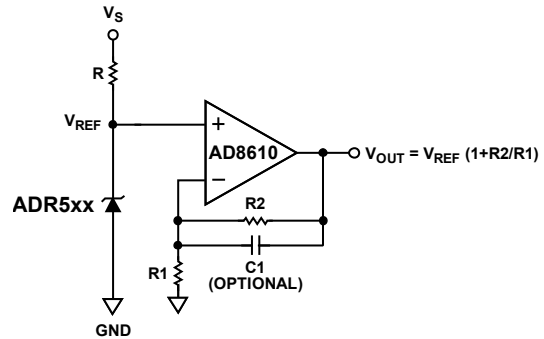
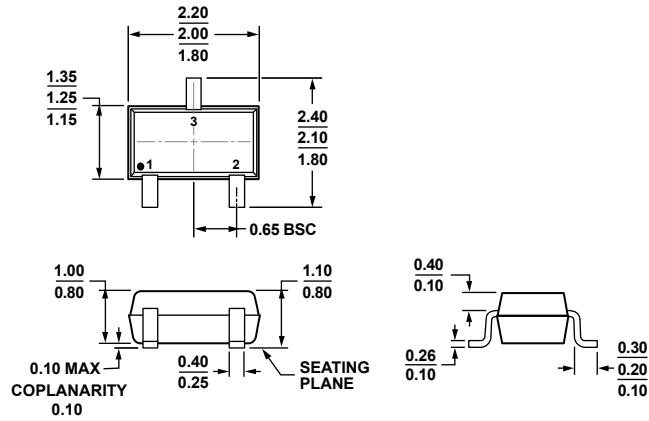

Figure 20. Adjustable Voltage Source

# OUTLINE DIMENSIONS



ALL DIMENSIONS COMPLIANT WITH EIAJ SC70

Figure 21. 3-Lead Thin Shrink Small Outline Transistor Package [SC70] (KS-3)

Dimensions shown in millimeters

072809-A

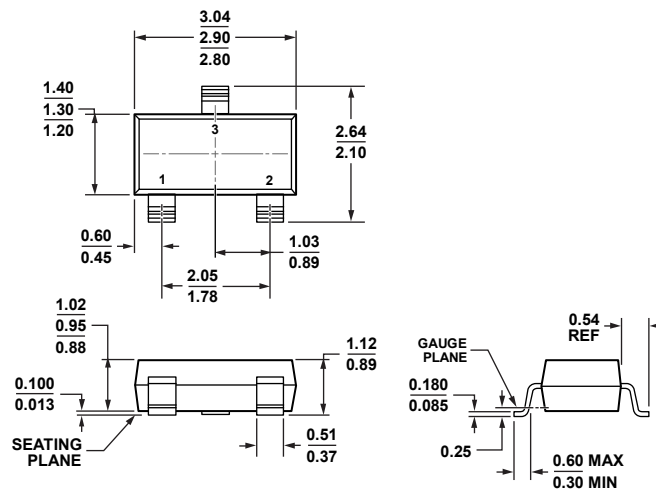

COMPLIANT TO JEDEC STANDARDS TO-236-AB

Figure 22. 3-Lead Small Outline Transistor Package [SOT-23-3] (RT-3)

Dimensions shown in millimeters

011909-C

# ADR525/ADR530/ADR550

## ORDERING GUIDE

Model <sup>1</sup>	Output Voltage (V)	Initial Accuracy (mV)	Tempco Industrial (ppm/°C)	Package Description	Package Option	Branding	Ordering Qty	Temperature Range
ADR525ART-REEL7	2.5	10	70	3-Lead SOT-23-3	RT-3	RRA	3,000	-40°C to +85°C
ADR525ARTZ-R2	2.5	10	70	3-Lead SOT-23-3	RT-3	R1W	250	-40°C to +85°C
ADR525ARTZ-REEL7	2.5	10	70	3-Lead SOT-23-3	RT-3	R1W	3,000	-40°C to +85°C
ADR525BKSZ-REEL7	2.5	5	40	3-Lead SC70	KS-3	R1N	3,000	-40°C to +85°C
ADR525BRTZ-REEL7	2.5	5	40	3-Lead SOT-23-3	RT-3	R1N	3,000	-40°C to +85°C
ADR530ARTZ-REEL7	3.0	12	70	3-Lead SOT-23-3	RT-3	R1X	3,000	-40°C to +85°C
ADR530BKSZ-REEL7	3.0	6	40	3-Lead SC70	KS-3	R1Y	3,000	-40°C to +85°C
ADR530BRTZ-REEL7	3.0	6	40	3-Lead SOT-23-3	RT-3	R1Y	3,000	-40°C to +85°C
ADR550ARTZ-REEL7	5.0	20	70	3-Lead SOT-23-3	RT-3	R1Q	3,000	-40°C to +85°C
ADR550BRTZ-REEL7	5.0	10	40	3-Lead SOT-23-3	RT-3	R1P	3,000	-40°C to +85°C

<sup>1</sup> Z = RoHS Compliant Part.

## X-ON Electronics

Largest Supplier of Electrical and Electronic Components

*Click to view similar products for [Voltage References](#) category:*

*Click to view products by [Analog Devices](#) manufacturer:*

Other Similar products are found below :

[REF01J/883](#) [5962-8686103XC](#) [NCV431BVDMR2G](#) [LT6654AMPS6-2.048#TRMPBF](#) [SCV431AIDMR2G](#) [SC431ILPRAG](#) [AP432AQG-7](#)  
[TL431-A](#) [MCP1502T-18E/CHY](#) [MCP1502T-40E/CHY](#) [TL431ACZ](#) [KA431SLMF2TF](#) [KA431SMF2TF](#) [KA431SMFTF](#) [LM4041C12ILPR](#)  
[LM4120AIM5-2.5/NOPB](#) [LM431SCCMFX](#) [REF5040MDREP](#) [REF3012AIDBZR](#) [LM285BXXM-1.2/NOPB](#) [LM385BM-2.5/NOPB](#)  
[LM4040AIM3-10.0](#) [LM4040BIM3-4.1](#) [LM4040CIM3-10.0](#) [LM4040CIM3X-2.0/NOPB](#) [LM4041BSD-122GT3](#) [LM4041QDIM3-ADJ/NO](#)  
[LM4050QAEM3X4.1/NOPB](#) [LM4051BIM3-ADJ/NOPB](#) [LM4051CIM3X-1.2/NOPB](#) [LM4128CMF-1.8/NOPB](#) [LM4132DMF-1.8/NOPB](#)  
[LM4132EMF-1.8/NOPB](#) [LM4132EMF-2.0/NOPB](#) [LM4140CCMX-1.2/NOPB](#) [LM385BD-2.5R2G](#) [LM385M-2.5/NOPB](#) [LM4030AMF-](#)  
[4.096/NOPB](#) [LM4040D30ILPR](#) [LM4051CIM3X-ADJ/NOPB](#) [AP432YG-13](#) [AS431ANTR-G1](#) [AS431BZTR-E1](#) [AN431AN-ATRG1](#)  
[AP431IBNTR-G1](#) [AS431ARTR-G1](#) [AS431BNTR-G1](#) [TL431AIZ](#) [AZ431AN-ATRG1](#) [AZ431AZ-ATRE1](#)