

FEATURES

- RF 1 × 1 transceiver with integrated 12-bit DACs and ADCs**
- Band: 70 MHz to 6.0 GHz**
- Supports time division duplex (TDD) and frequency division duplex (FDD) operation**
- Tunable channel bandwidth (BW): <200 kHz to 56 MHz**
- 3-band receiver: 3 differential or 6 single-ended inputs**
- Superior receiver sensitivity with a noise figure of <2.5 dB**
- Rx gain control**
 - Real-time monitor and control signals for manual gain
 - Independent automatic gain control
- 2-band differential output transmitter**
- Highly linear broadband transmitter**
 - Tx EVM: ≤−40 dB
 - Tx noise: ≤−157 dBm/Hz noise floor
 - Tx monitor: ≥66 dB dynamic range with 1 dB accuracy
- Integrated fractional-N synthesizers**
 - 2.4 Hz maximum local oscillator (LO) step size
- Multichip synchronization**
- CMOS/LVDS digital interface**

APPLICATIONS

- Point to point communication systems
- Femtocell/picocell/microcell base stations
- General-purpose radio systems

GENERAL DESCRIPTION

The **AD9364** is a high performance, highly integrated radio frequency (RF) Agile Transceiver™ designed for use in 3G and 4G base station applications. Its programmability and wideband capability make it ideal for a broad range of transceiver applications.

The device combines an RF front end with a flexible mixed-signal baseband section and integrated frequency synthesizers, simplifying design-in by providing a configurable digital interface to a processor. The **AD9364** operates in the 70 MHz to 6.0 GHz range, covering most licensed and unlicensed bands. Channel bandwidths from less than 200 kHz to 56 MHz are supported.

The direct conversion receiver has state-of-the-art noise figure and linearity. The receive (Rx) subsystem includes independent automatic gain control (AGC), dc offset correction, quadrature correction, and digital filtering, thereby eliminating the need for these functions in the digital baseband. The **AD9364** also has flexible manual gain modes that can be externally controlled. Two high dynamic range ADCs digitize the received I and Q signals and pass them through configurable decimation filters

FUNCTIONAL BLOCK DIAGRAM



- NOTES
1. SPI, CTRL, P0 [D11:D0]/TX [D5:D0], P1 [D11:D0]/RX [D5:D0], AND RADIO SWITCHING CONTAIN MULTIPLE PINS.

Figure 1.

1184E-001

and 128-tap FIR filters to produce a 12-bit output signal at the appropriate sample rate.

The transmitter uses a direct conversion architecture that achieves high modulation accuracy with ultralow noise. This transmitter design produces a Tx EVM of ≤−40 dB, allowing significant system margin for the external power amplifier (PA) selection. The on-board transmit (Tx) power monitor can be used as a power detector, enabling highly accurate Tx power measurements.

The fully integrated phase-locked loops (PLLs) provide low power fractional-N frequency synthesis for all Rx and Tx channels. All VCO and loop filter components are integrated.

The core of the **AD9364** can be powered directly from a 1.3 V regulator. The IC is controlled via a standard 4-wire serial port and four real-time input control pins. Comprehensive power-down modes are included to minimize power consumption during normal use. The **AD9364** is packaged in a 10 mm × 10 mm, 144-ball chip scale package ball grid array (CSP_BGA).

Rev. C

[Document Feedback](#)

Information furnished by Analog Devices is believed to be accurate and reliable. However, no responsibility is assumed by Analog Devices for its use, nor for any infringements of patents or other rights of third parties that may result from its use. Specifications subject to change without notice. No license is granted by implication or otherwise under any patent or patent rights of Analog Devices. Trademarks and registered trademarks are the property of their respective owners.

TABLE OF CONTENTS

| | | | |
|--|----|--|----|
| Features | 1 | 5.5 GHz Frequency Band | 24 |
| Applications..... | 1 | Theory of Operation | 28 |
| Functional Block Diagram | 1 | General..... | 28 |
| General Description | 1 | Receiver..... | 28 |
| Revision History | 2 | Transmitter..... | 28 |
| Specifications..... | 3 | Clock Input Options | 28 |
| Current Consumption—VDD_Interface | 7 | Synthesizers | 29 |
| Current Consumption—VDDD1P3_DIG and VDDAx (Combination of All 1.3 V Supplies) | 8 | Digital Data Interface..... | 29 |
| Absolute Maximum Ratings | 10 | Enable State Machine | 29 |
| Reflow Profile..... | 10 | SPI Interface | 30 |
| Thermal Resistance | 10 | Control Pins | 30 |
| ESD Caution..... | 10 | GPO Pins (GPO_3 to GPO_0) | 30 |
| Pin Configuration and Function Descriptions..... | 11 | Auxiliary Converters..... | 30 |
| Typical Performance Characteristics | 15 | Powering the AD9364..... | 30 |
| 800 MHz Frequency Band..... | 15 | Packaging and Ordering Information | 31 |
| 2.4 GHz Frequency Band | 20 | Outline Dimensions..... | 31 |
| | | Ordering Guide | 31 |

REVISION HISTORY

7/14—Rev. B to Rev. C

| | |
|---|----|
| Changed CMOS VDD_INTERFACE from 1.2 V (min)/2.5 V (max) to 1.14 V (min)/2.625 V (max); and Changed LVDS VDD_INTERFACE from 1.8 V (min)/2.5 V (max) to 1.71 V (min)/2.625 V (max); Table 1..... | 7 |
| Added Powering the AD9364 Section | 30 |

2/14—Revision B: Initial Version

SPECIFICATIONS

Electrical characteristics at VDD_GPO = 3.3 V, VDD_INTERFACE = 1.8 V, and all other VDDx pins = 1.3 V, T_A = 25°C, unless otherwise noted.

Table 1.

| Parameter ¹ | Symbol | Min | Typ | Max | Unit | Test Conditions/Comments |
|--|--------|-----|------|------|---------|--|
| RECEIVER, GENERAL | | | | | | |
| Center Frequency | | 70 | | 6000 | MHz | |
| Gain | | | | | | |
| Minimum | | | 0 | | dB | |
| Maximum | | | 74.5 | | dB | At 800 MHz |
| | | | 73.0 | | dB | At 2300 MHz, RXA |
| | | | 72.0 | | dB | At 2300 MHz, RXB, RXC |
| | | | 65.5 | | dB | At 5500 MHz, RXA |
| Gain Step | | | 1 | | dB | |
| Received Signal Strength Indicator | RSSI | | | | | |
| Range | | | 100 | | dB | |
| Accuracy | | | ±2 | | dB | |
| RECEIVER, 800 MHz | | | | | | |
| Noise Figure | NF | | 2 | | dB | Maximum Rx gain |
| Third-Order Input Intermodulation Intercept Point | IIP3 | | -18 | | dBm | Maximum Rx gain |
| Second-Order Input Intermodulation Intercept Point | IIP2 | | 40 | | dBm | Maximum Rx gain |
| Local Oscillator (LO) Leakage Quadrature | | | -122 | | dBm | At Rx front-end input |
| Gain Error | | | 0.2 | | % | |
| Phase Error | | | 0.2 | | Degrees | |
| Modulation Accuracy (EVM) | | | -42 | | dB | 19.2 MHz reference clock |
| Input S ₁₁ | | | -10 | | dB | |
| RECEIVER, 2.4 GHz | | | | | | |
| Noise Figure | NF | | 3 | | dB | Maximum Rx gain |
| Third-Order Input Intermodulation Intercept Point | IIP3 | | -14 | | dBm | Maximum Rx gain |
| Second-Order Input Intermodulation Intercept Point | IIP2 | | 45 | | dBm | Maximum Rx gain |
| Local Oscillator (LO) Leakage Quadrature | | | -110 | | dBm | At Rx front-end input |
| Gain Error | | | 0.2 | | % | |
| Phase Error | | | 0.2 | | Degrees | |
| Modulation Accuracy (EVM) | | | -42 | | dB | 40 MHz reference clock |
| Input S ₁₁ | | | -10 | | dB | |
| RECEIVER, 5.5 GHz | | | | | | |
| Noise Figure | NF | | 3.8 | | dB | Maximum Rx gain |
| Third-Order Input Intermodulation Intercept Point | IIP3 | | -17 | | dBm | Maximum Rx gain |
| Second-Order Input Intermodulation Intercept Point | IIP2 | | 42 | | dBm | Maximum Rx gain |
| Local Oscillator (LO) Leakage Quadrature | | | -95 | | dBm | At Rx front-end input |
| Gain Error | | | 0.2 | | % | |
| Phase Error | | | 0.2 | | Degrees | |
| Modulation Accuracy (EVM) | | | -37 | | dB | 40 MHz reference clock (doubled internally for RF synthesizer) |
| Input S ₁₁ | | | -10 | | dB | |
| TRANSMITTER—GENERAL | | | | | | |
| Center Frequency | | 70 | | 6000 | MHz | |
| Power Control Range | | | 90 | | dB | |
| Power Control Resolution | | | 0.25 | | dB | |

| Parameter ¹ | Symbol | Min | Typ | Max | Unit | Test Conditions/Comments |
|--|--------|-----|-------------------|-----|----------------|---|
| TRANSMITTER, 800 MHz | | | | | | |
| Output S_{22} | | | -10 | | dB | |
| Maximum Output Power | | | 8 | | dBm | 1 MHz tone into 50 Ω load |
| Modulation Accuracy (EVM) | | | -40 | | dB | 19.2 MHz reference clock |
| Third-Order Output Intermodulation Intercept Point | OIP3 | | 23 | | dBm | |
| Carrier Leakage | | | -50 | | dBc | 0 dB attenuation |
| | | | -32 | | dBc | 40 dB attenuation |
| Noise Floor | | | -157 | | dBm/Hz | 90 MHz offset |
| TRANSMITTER, 2.4 GHz | | | | | | |
| Output S_{22} | | | -10 | | dB | |
| Maximum Output Power | | | 7.5 | | dBm | 1 MHz tone into 50 Ω load |
| Modulation Accuracy (EVM) | | | -40 | | dB | 40 MHz reference clock |
| Third-Order Output Intermodulation Intercept Point | OIP3 | | 19 | | dBm | |
| Carrier Leakage | | | -50 | | dBc | 0 dB attenuation |
| | | | -32 | | dBc | 40 dB attenuation |
| Noise Floor | | | -156 | | dBm/Hz | 90 MHz offset |
| TRANSMITTER, 5.5 GHz | | | | | | |
| Output S_{22} | | | -10 | | dB | |
| Maximum Output Power | | | 6.5 | | dBm | 7 MHz tone into 50 Ω load |
| Modulation Accuracy (EVM) | | | -36 | | dB | 40 MHz reference clock (doubled internally for RF synthesizer) |
| Third-Order Output Intermodulation Intercept Point | OIP3 | | 17 | | dBm | |
| Carrier Leakage | | | -50 | | dBc | 0 dB attenuation |
| | | | -30 | | dBc | 40 dB attenuation |
| Noise Floor | | | -151.5 | | dBm/Hz | 90 MHz offset |
| TX MONITOR INPUT (TX_MON) | | | | | | |
| Maximum Input Level | | | 4 | | dBm | |
| Dynamic Range | | | 66 | | dB | |
| Accuracy | | | 1 | | dB | |
| LO SYNTHESIZER | | | | | | |
| LO Frequency Step | | | 2.4 | | Hz | 2.4 GHz, 40 MHz reference clock |
| Integrated Phase Noise | | | | | $^{\circ}$ rms | |
| 800 MHz | | | 0.13 | | | 100 Hz to 100 MHz, 30.72 MHz reference clock (doubled internally for RF synthesizer) |
| 2.4 GHz | | | 0.37 | | | 100 Hz to 100 MHz, 40 MHz reference clock |
| 5.5 GHz | | | 0.59 | | | 100 Hz to 100 MHz, 40 MHz reference clock (doubled internally for RF synthesizer) |
| REFERENCE CLOCK (REF_CLK) | | | | | | |
| Input | | | | | | REF_CLK is either the input to the XTALP/XTALN pins or a line directly to the XTALN pin |
| Frequency Range | | 19 | | 50 | MHz | Crystal input |
| | | 10 | | 80 | MHz | External oscillator |
| Signal Level | | | 1.3 | | V p-p | AC-coupled external oscillator |
| AUXILIARY CONVERTERS | | | | | | |
| ADC | | | | | | |
| Resolution | | | 12 | | Bits | |
| Input Voltage | | | | | | |
| Minimum | | | 0.05 | | V | |
| Maximum | | | VDDA1P3_BB - 0.05 | | V | |
| DAC | | | | | | |
| Resolution | | | 10 | | Bits | |

| Parameter ¹ | Symbol | Min | Typ | Max | Unit | Test Conditions/Comments |
|--|------------------|---------------------|---------------|-----------------------|------|--|
| Output Voltage | | | 0.5 | | V | |
| Minimum | | | VDD_GPO – 0.3 | | V | |
| Maximum | | | | | V | |
| Output Current | | | 10 | | mA | |
| DIGITAL SPECIFICATIONS (CMOS) | | | | | | |
| Logic Inputs | | | | | | |
| Input Voltage | | | | | | |
| High | | VDD_INTERFACE × 0.8 | | VDD_INTERFACE | V | |
| Low | | 0 | | VDD_INTERFACE × 0.2 | V | |
| Input Current | | | | | | |
| High | | –10 | | +10 | μA | |
| Low | | –10 | | +10 | μA | |
| Logic Outputs | | | | | | |
| Output Voltage | | | | | | |
| High | | VDD_INTERFACE × 0.8 | | | V | |
| Low | | | | VDD_INTERFACE × 0.2 | V | |
| DIGITAL SPECIFICATIONS (LVDS) | | | | | | |
| Logic Inputs | | | | | | |
| Input Voltage Range | | 825 | | 1575 | mV | Each differential input in the pair |
| Input Differential Voltage Threshold | | –100 | | +100 | mV | |
| Receiver Differential Input Impedance | | | 100 | | Ω | |
| Logic Outputs | | | | | | |
| Output Voltage | | | | | | |
| High | | | | 1375 | mV | |
| Low | | 1025 | | | mV | |
| Output Differential Voltage | | 150 | | | mV | Programmable in 75 mV steps |
| Output Offset Voltage | | | 1200 | | mV | |
| GENERAL-PURPOSE OUTPUTS | | | | | | |
| Output Voltage | | | | | | |
| High | | VDD_GPO × 0.8 | | | V | |
| Low | | | | VDD_GPO × 0.2 | V | |
| Output Current | | | 10 | | mA | |
| SPI TIMING | | | | | | |
| VDD_INTERFACE = 1.8 V | | | | | | |
| SPI_CLK | | | | | | |
| Period | t _{CP} | 20 | | | ns | |
| Pulse Width | t _{MP} | 9 | | | ns | |
| SPI_ENB Setup to First SPI_CLK Rising Edge | t _{SC} | 1 | | | ns | |
| Last SPI_CLK Falling Edge to SPI_ENB Hold | t _{HC} | 0 | | | ns | |
| SPI_DI | | | | | | |
| Data Input Setup to SPI_CLK | t _S | 2 | | | ns | |
| Data Input Hold to SPI_CLK | t _H | 1 | | | ns | |
| SPI_CLK Rising Edge to Output Data Delay | | | | | | |
| 4-Wire Mode | t _{CO} | 3 | | 8 | ns | |
| 3-Wire Mode | t _{CO} | 3 | | 8 | ns | |
| Bus Turnaround Time, Read | t _{HZM} | t _H | | t _{CO (max)} | ns | After baseband processor (BBP) drives the last address bit |
| Bus Turnaround Time, Read | t _{HZS} | 0 | | t _{CO (max)} | ns | After the AD9364 drives the last data bit |

| Parameter ¹ | Symbol | Min | Typ | Max | Unit | Test Conditions/Comments |
|--|----------------------|------------------------|-----|------------------------|------|---------------------------|
| DIGITAL DATA TIMING (CMOS), VDD_INTERFACE = 1.8 V | | | | | | |
| DATA_CLK Clock Period | t _{CP} | 16.276 | | | ns | 61.44 MHz |
| DATA_CLK and FB_CLK Pulse Width | t _{MP} | 45% of t _{CP} | | 55% of t _{CP} | ns | |
| Tx Data | | | | | | TX_FRAME, P0_D, and P1_D |
| Setup to FB_CLK | t _{STX} | 1 | | | ns | |
| Hold to FB_CLK | t _{HTX} | 0 | | | ns | |
| DATA_CLK to Data Bus Output Delay | t _{DDR} | 0 | | 1.5 | ns | |
| DATA_CLK to RX_FRAME Delay | t _{DDV} | 0 | | 1.0 | ns | |
| Pulse Width | | | | | | |
| ENABLE | t _{ENPW} | t _{CP} | | | ns | |
| TXNRX | t _{TXNRXPW} | t _{CP} | | | ns | FDD independent ENSM mode |
| TXNRX Setup to ENABLE | t _{TXNRXSU} | 0 | | | ns | TDD ENSM mode |
| Bus Turnaround Time | | | | | | |
| Before Rx | t _{RPRE} | 2 × t _{CP} | | | ns | TDD mode |
| After Rx | t _{RPST} | 2 × t _{CP} | | | ns | TDD mode |
| Capacitive Load | | | 3 | | pF | |
| Capacitive Input | | | 3 | | pF | |
| DIGITAL DATA TIMING (CMOS), VDD_INTERFACE = 2.5 V | | | | | | |
| DATA_CLK Clock Period | t _{CP} | 16.276 | | | ns | 61.44 MHz |
| DATA_CLK and FB_CLK Pulse Width | t _{MP} | 45% of t _{CP} | | 55% of t _{CP} | ns | |
| Tx Data | | | | | | TX_FRAME, P0_D, and P1_D |
| Setup to FB_CLK | t _{STX} | 1 | | | ns | |
| Hold to FB_CLK | t _{HTX} | 0 | | | ns | |
| DATA_CLK to Data Bus Output Delay | t _{DDR} | 0 | | 1.2 | ns | |
| DATA_CLK to RX_FRAME Delay | t _{DDV} | 0 | | 1.0 | ns | |
| Pulse Width | | | | | | |
| ENABLE | t _{ENPW} | t _{CP} | | | ns | |
| TXNRX | t _{TXNRXPW} | t _{CP} | | | ns | FDD independent ENSM mode |
| TXNRX Setup to ENABLE | t _{TXNRXSU} | 0 | | | ns | TDD ENSM mode |
| Bus Turnaround Time | | | | | | |
| Before Rx | t _{RPRE} | 2 × t _{CP} | | | ns | TDD mode |
| After Rx | t _{RPST} | 2 × t _{CP} | | | ns | TDD mode |
| Capacitive Load | | | 3 | | pF | |
| Capacitive Input | | | 3 | | pF | |
| DIGITAL DATA TIMING (LVDS) | | | | | | |
| DATA_CLK Clock Period | t _{CP} | 4.069 | | | ns | 245.76 MHz |
| DATA_CLK and FB_CLK Pulse Width | t _{MP} | 45% of t _{CP} | | 55% of t _{CP} | ns | |
| Tx Data | | | | | | TX_FRAME and TX_D |
| Setup to FB_CLK | t _{STX} | 1 | | | ns | |
| Hold to FB_CLK | t _{HTX} | 0 | | | ns | |
| DATA_CLK to Data Bus Output Delay | t _{DDR} | 0.25 | | 1.25 | ns | |
| DATA_CLK to RX_FRAME Delay | t _{DDV} | 0.25 | | 1.25 | ns | |
| Pulse Width | | | | | | |
| ENABLE | t _{ENPW} | t _{CP} | | | ns | |
| TXNRX | t _{TXNRXPW} | t _{CP} | | | ns | FDD independent ENSM mode |
| TXNRX Setup to ENABLE | t _{TXNRXSU} | 0 | | | ns | TDD ENSM mode |

| Parameter ¹ | Symbol | Min | Typ | Max | Unit | Test Conditions/Comments |
|--------------------------------|------------|-------------------|-----|-------|---------|--|
| Bus Turnaround Time | | | | | | |
| Before Rx | t_{RPRE} | $2 \times t_{CP}$ | | | ns | |
| After Rx | t_{RPST} | $2 \times t_{CP}$ | | | ns | |
| Capacitive Load | | | 3 | | pF | |
| Capacitive Input | | | 3 | | pF | |
| SUPPLY CHARACTERISTICS | | | | | | |
| 1.3 V Main Supply Voltage | | 1.267 | 1.3 | 1.33 | V | |
| VDD_INTERFACE Supply | | | | | | |
| Nominal Settings | | | | | | |
| CMOS | | 1.14 | | 2.625 | V | |
| LVDS | | 1.71 | | 2.625 | V | |
| VDD_INTERFACE Tolerance | | -5 | | +5 | % | Tolerance is applicable to any voltage setting |
| VDD_GPO Supply Nominal Setting | | 1.3 | | 3.3 | V | When unused, must be set to 1.3 V |
| VDD_GPO Tolerance | | -5 | | +5 | % | Tolerance is applicable to any voltage setting |
| Current Consumption | | | | | | |
| VDDx, Sleep Mode | | | 180 | | μ A | Sum of all input currents |
| VDD_GPO | | | 50 | | μ A | No load |

¹ When referencing a single function of a multifunction pin in the parameters, only the portion of the pin name that is relevant to the specification is listed. For full pin names of multifunction pins, refer to the Pin Configuration and Function Descriptions section.

CURRENT CONSUMPTION—VDD_INTERFACE

Table 2. VDD_INTERFACE = 1.2 V

| Parameter | Min | Typ | Max | Unit | Test Conditions/Comments |
|-----------------------------------|-----|-----|-----|---------|--------------------------------|
| SLEEP MODE | | 45 | | μ A | Power applied, device disabled |
| RX AND TX, DOUBLE DATA RATE (DDR) | | | | | |
| LTE 10 MHz | | | | | |
| Single Port | | 2.9 | | mA | 30.72 MHz data clock, CMOS |
| Dual Port | | 2.7 | | mA | 15.36 MHz data clock, CMOS |
| LTE 20 MHz | | | | | |
| Dual Port | | 5.2 | | mA | 30.72 MHz data clock, CMOS |

Table 3. VDD_INTERFACE = 1.8 V

| Parameter | Min | Typ | Max | Unit | Test Conditions/Comments |
|----------------|-----|-----|-----|---------|--------------------------------|
| SLEEP MODE | | 84 | | μ A | Power applied, device disabled |
| RX AND TX, DDR | | | | | |
| LTE 10 MHz | | | | | |
| Single Port | | 4.5 | | mA | 30.72 MHz data clock, CMOS |
| Dual Port | | 4.1 | | mA | 15.36 MHz data clock, CMOS |
| LTE 20 MHz | | | | | |
| Dual Port | | 8.0 | | mA | 30.72 MHz data clock, CMOS |

Table 4. VDD_INTERFACE = 2.5 V

| Parameter | Min | Typ | Max | Unit | Test Conditions/Comments |
|----------------|-----|------|-----|---------|--------------------------------|
| SLEEP MODE | | 150 | | μ A | Power applied, device disabled |
| RX AND TX, DDR | | | | | |
| LTE 10 MHz | | | | | |
| Single Port | | 6.5 | | mA | 30.72 MHz data clock, CMOS |
| Dual Port | | 6.0 | | mA | 15.36 MHz data clock, CMOS |
| LTE 20 MHz | | | | | |
| Dual Port | | 11.5 | | mA | 30.72 MHz data clock, CMOS |

CURRENT CONSUMPTION—VDDD1P3_DIG AND VDDAx (COMBINATION OF ALL 1.3 V SUPPLIES)

Table 5. 800 MHz, TDD Mode

| Parameter | Min | Typ | Max | Unit | Test Conditions/Comments |
|------------------|-----|-----|-----|------|--------------------------|
| RX | | | | | |
| 5 MHz Bandwidth | | 180 | | mA | Continuous Rx |
| 10 MHz Bandwidth | | 210 | | mA | Continuous Rx |
| 20 MHz Bandwidth | | 260 | | mA | Continuous Rx |
| TX | | | | | |
| 5 MHz Bandwidth | | | | | |
| 7 dBm | | 340 | | mA | Continuous Tx |
| -27 dBm | | 190 | | mA | Continuous Tx |
| 10 MHz Bandwidth | | | | | |
| 7 dBm | | 360 | | mA | Continuous Tx |
| -27 dBm | | 220 | | mA | Continuous Tx |
| 20 MHz Bandwidth | | | | | |
| 7 dBm | | 400 | | mA | Continuous Tx |
| -27 dBm | | 250 | | mA | Continuous Tx |

Table 6. TDD Mode, 2.4 GHz

| Parameter | Min | Typ | Max | Unit | Test Conditions/Comments |
|------------------|-----|-----|-----|------|--------------------------|
| RX | | | | | |
| 5 MHz Bandwidth | | 175 | | mA | Continuous Rx |
| 10 MHz Bandwidth | | 200 | | mA | Continuous Rx |
| 20 MHz Bandwidth | | 240 | | mA | Continuous Rx |
| TX | | | | | |
| 5 MHz Bandwidth | | | | | |
| 7 dBm | | 350 | | mA | Continuous Tx |
| -27 dBm | | 160 | | mA | Continuous Tx |
| 10 MHz Bandwidth | | | | | |
| 7 dBm | | 380 | | mA | Continuous Tx |
| -27 dBm | | 220 | | mA | Continuous Tx |
| 20 MHz Bandwidth | | | | | |
| 7 dBm | | 410 | | mA | Continuous Tx |
| -27 dBm | | 260 | | mA | Continuous Tx |

Table 7. TDD Mode, 5.5 GHz

| Parameter | Min | Typ | Max | Unit | Test Conditions/Comments |
|------------------|-----|-----|-----|------|--------------------------|
| RX | | | | | |
| 5 MHz Bandwidth | | 175 | | mA | Continuous Rx |
| 40 MHz Bandwidth | | 275 | | mA | Continuous Rx |
| TX | | | | | |
| 5 MHz Bandwidth | | | | | |
| 7 dBm | | 400 | | mA | Continuous Tx |
| -27 dBm | | 240 | | mA | Continuous Tx |
| 40 MHz Bandwidth | | | | | |
| 7 dBm | | 490 | | mA | Continuous Tx |
| -27 dBm | | 385 | | mA | Continuous Tx |

Table 8. FDD Mode, 800 MHz

| Parameter | Min | Typ | Max | Unit | Test Conditions/Comments |
|------------------|-----|-----|-----|------|--------------------------|
| RX AND TX | | | | | |
| 5 MHz Bandwidth | | | | | |
| 7 dBm | | 490 | | mA | |
| -27 dBm | | 345 | | mA | |
| 10 MHz Bandwidth | | | | | |
| 7 dBm | | 540 | | mA | |
| -27 dBm | | 395 | | mA | |
| 20 MHz Bandwidth | | | | | |
| 7 dBm | | 615 | | mA | |
| -27 dBm | | 470 | | mA | |

Table 9. FDD Mode, 2.4 GHz

| Parameter | Min | Typ | Max | Unit | Test Conditions/Comments |
|------------------|-----|-----|-----|------|--------------------------|
| RX AND TX | | | | | |
| 5 MHz Bandwidth | | | | | |
| 7 dBm | | 500 | | mA | |
| -27 dBm | | 350 | | mA | |
| 10 MHz Bandwidth | | | | | |
| 7 dBm | | 540 | | mA | |
| -27 dBm | | 390 | | mA | |
| 20 MHz Bandwidth | | | | | |
| 7 dBm | | 620 | | mA | |
| -27 dBm | | 475 | | mA | |

Table 10. FDD Mode, 5.5 GHz

| Parameter | Min | Typ | Max | Unit | Test Conditions/Comments |
|-----------------|-----|-----|-----|------|--------------------------|
| RX AND TX | | | | | |
| 5 MHz Bandwidth | | | | | |
| 7 dBm | | 550 | | mA | |
| -27 dBm | | 385 | | mA | |

ABSOLUTE MAXIMUM RATINGS

Table 11.

| Parameter | Rating |
|---|---------------------------------|
| VDDx to VSSx | −0.3 V to +1.4 V |
| VDD_INTERFACE to VSSx | −0.3 V to +3.0 V |
| VDD_GPO to VSSx | −0.3 V to +3.9 V |
| Logic Inputs and Outputs to VSSx | −0.3 V to VDD_INTERFACE + 0.3 V |
| Input Current to Any Pin Except Supplies | ±10 mA |
| RF Inputs (Peak Power) | 2.5 dBm |
| Tx Monitor Input Power (Peak Power) | 9 dBm |
| Package Power Dissipation | $(T_{JMAX} - T_A)/\theta_{JA}$ |
| Maximum Junction Temperature (T_{JMAX}) | 110°C |
| Operating Temperature Range | −40°C to +85°C |
| Storage Temperature Range | −65°C to +150°C |

Stresses at or above those listed under Absolute Maximum Ratings may cause permanent damage to the product. This is a stress rating only; functional operation of the product at these or any other conditions above those indicated in the operational section of this specification is not implied. Operation beyond the maximum operating conditions for extended periods may affect product reliability.

REFLOW PROFILE

The AD9364 reflow profile is in accordance with the JEDEC JESD20 criteria for Pb-free devices. The maximum reflow temperature is 260°C.

THERMAL RESISTANCE

θ_{JA} is specified for the worst-case conditions, that is, a device soldered in a circuit board for surface-mount packages.

Table 12. Thermal Resistance

| Package Type | Airflow Velocity (m/sec) | $\theta_{JA}^{1,2}$ | $\theta_{JC}^{1,3}$ | $\theta_{JB}^{1,4}$ | $\Psi_{JT}^{1,2}$ | Unit |
|------------------|--------------------------|---------------------|---------------------|---------------------|-------------------|------|
| 144-Ball CSP_BGA | 0 | 32.3 | 9.6 | 20.2 | 0.27 | °C/W |
| | 1.0 | 29.6 | | | 0.43 | °C/W |
| | 2.5 | 27.8 | | | 0.57 | °C/W |

¹ Per JEDEC JESD51-7, plus JEDEC JESD51-5 2S2P test board.

² Per JEDEC JESD51-2 (still air) or JEDEC JESD51-6 (moving air).

³ Per MIL-STD 883, Method 1012.1.

⁴ Per JEDEC JESD51-8 (still air).

ESD CAUTION**ESD (electrostatic discharge) sensitive device.**

Charged devices and circuit boards can discharge without detection. Although this product features patented or proprietary protection circuitry, damage may occur on devices subjected to high energy ESD. Therefore, proper ESD precautions should be taken to avoid performance degradation or loss of functionality.

PIN CONFIGURATION AND FUNCTION DESCRIPTIONS

| | 1 | 2 | 3 | 4 | 5 | 6 | 7 | 8 | 9 | 10 | 11 | 12 |
|---|--------------|--------------------|----------------------|-------------|-----------|-----------|----------------|----------------|---------------|--------------------|----------------|---------------|
| A | VSSA | VSSA | NC | VSSA | VSSA | VSSA | VDDA1P3_RX_TX | VDDA1P3_RX_TX | VDDA1P3_RX_TX | VDDA1P3_RX_TX | VDDA1P1_TX_VCO | TX_EXT_LO_IN |
| B | VSSA | VSSA | AUXDAC1 | GPO_3 | GPO_2 | GPO_1 | GPO_0 | VDD_GPO | VDDA1P3_TX_LO | VDDA1P3_TX_VCO_LDO | TX_VCO_LDO_OUT | VSSA |
| C | VSSA | VSSA | AUXDAC2 | TEST/ENABLE | CTRL_IN0 | CTRL_IN1 | VSSA | VSSA | VSSA | VSSA | VSSA | VSSA |
| D | VSSA | VDDA1P3_RX_RF | VDDA1P3_RX_TX | CTRL_OUT0 | CTRL_IN3 | CTRL_IN2 | P0_D9/TX_D4_P | P0_D7/TX_D3_P | P0_D5/TX_D2_P | P0_D3/TX_D1_P | P0_D1/TX_D0_P | VSSD |
| E | VSSA | VDDA1P3_RX_LO | VDDA1P3_TX_LO_BUFFER | CTRL_OUT1 | CTRL_OUT2 | CTRL_OUT3 | P0_D11/TX_D5_P | P0_D8/TX_D4_N | P0_D6/TX_D3_N | P0_D4/TX_D2_N | P0_D2/TX_D1_N | P0_D0/TX_D0_N |
| F | VSSA | VDDA1P3_RX_VCO_LDO | VSSA | CTRL_OUT6 | CTRL_OUT5 | CTRL_OUT4 | VSSD | P0_D10/TX_D5_N | VSSD | FB_CLK_P | VSSD | VDDD1P3_DIG |
| G | RX_EXT_LO_IN | RX_VCO_LDO_OUT | VDDA1P1_RX_VCO | CTRL_OUT7 | EN_AGC | ENABLE | RX_FRAME_N | RX_FRAME_P | TX_FRAME_P | FB_CLK_N | DATA_CLK_P | VSSD |
| H | RXB_P | VSSA | VSSA | TXNRX | SYNC_IN | VSSA | VSSD | P1_D11/RX_D5_P | TX_FRAME_N | VSSD | DATA_CLK_N | VDD_INTERFACE |
| J | RXB_N | VSSA | VDDA1P3_RX_SYNTH | SPI_DI | SPI_CLK | CLK_OUT | P1_D10/RX_D5_N | P1_D9/RX_D4_P | P1_D7/RX_D3_P | P1_D5/RX_D2_P | P1_D3/RX_D1_P | P1_D1/RX_D0_P |
| K | RXC_P | VSSA | VDDA1P3_TX_SYNTH | VDDA1P3_BB | RESETB | SPI_ENB | P1_D8/RX_D4_N | P1_D6/RX_D3_N | P1_D4/RX_D2_N | P1_D2/RX_D1_N | P1_D0/RX_D0_N | VSSD |
| L | RXC_N | VSSA | VSSA | RBIAS | AUXADC | SPI_DO | VSSA | VSSA | VSSA | VSSA | VSSA | VSSA |
| M | RXA_P | RXA_N | NC | VSSA | TX_MON | VSSA | TXA_P | TXA_N | TXB_P | TXB_N | XTALP | XTALN |

■ ANALOG I/O ■ DC POWER
■ DIGITAL I/O ■ GROUND
 NO CONNECT

Figure 2. Pin Configuration, Top View

11846-002

Table 13. Pin Function Descriptions

| Pin No. | Type ¹ | Mnemonic | Description |
|---|-------------------|--------------------|---|
| A1, A2, A4 to A6, B1, B2, B12, C1, C2, C7 to C12, D1, E1, F1, F3, H2, H3, H6, J2, K2, L2, L3, L7 to L12, M4, M6 | I | VSSA | Analog Ground. Tie these pins directly to the VSSD digital ground on the printed circuit board (one ground plane). |
| A3, M3 | NC | NC | No Connect. Do not connect to these pins. |
| A7 to A10, D3 | I | VDDA1P3_RX_TX | 1.3 V Supply Input. |
| A11 | I | VDDA1P1_TX_VCO | Transmit VCO Supply Input. Connect to B11. |
| A12 | I | TX_EXT_LO_IN | External Transmit Local Oscillator (LO) Input. When this pin is unused, tie it to ground. |
| B3 | O | AUXDAC1 | Auxiliary DAC 1 Output. |
| B4 to B7 | O | GPO_3 to GPO_0 | 3.3 V Capable General-Purpose Outputs. |
| B8 | I | VDD_GPO | 2.5 V to 3.3 V Supply for the Auxiliary DAC and General-Purpose Output Pins. When the VDD_GPO supply is not used, this supply must be set to 1.3 V. |
| B9 | I | VDDA1P3_TX_LO | Transmit LO 1.3 V Supply Input. |
| B10 | I | VDDA1P3_TX_VCO_LDO | Transmit VCO LDO 1.3 V Supply Input. Connect to B9. |
| B11 | O | TX_VCO_LDO_OUT | Transmit VCO LDO Output. Connect B11 to A11 and a 1 μF bypass capacitor in series with a 1 Ω resistor to ground. |
| C3 | O | AUXDAC2 | Auxiliary DAC 2 Output. |
| C4 | I | TEST/ENABLE | Test Input. Ground this pin for normal operation. |

| Pin No. | Type ¹ | Mnemonic | Description |
|---|-------------------|--|--|
| C5, C6, D6, D5 | I | CTRL_IN0 to CTRL_IN3 | Control Inputs. Use C5, C6, D5, and D6 for manual Rx gain and Tx attenuation control. |
| D2 | I | VDDA1P3_RX_RF | Receiver 1.3 V Supply Input. Connect to D3. |
| D4, E4 to E6, F4 to F6, G4 | O | CTRL_OUT0, CTRL_OUT1 to CTRL_OUT3, CTRL_OUT6 to CTRL_OUT4, CTRL_OUT7 | Control Outputs. These pins are multipurpose outputs that have programmable functionality. |
| D7 | I/O | P0_D9/TX_D4_P | Digital Data Port P0/Transmit Differential Input Bus. This is a dual function pin. As P0_D9, it functions as part of the 12-bit, bidirectional, parallel CMOS level Data Port 0. Alternatively, this pin (TX_D4_P) can function as part of the LVDS 6-bit Tx differential input bus with internal LVDS termination. |
| D8 | I/O | P0_D7/TX_D3_P | Digital Data Port P0/Transmit Differential Input Bus. This is a dual function pin. As P0_D7, it functions as part of the 12-bit bidirectional parallel CMOS level Data Port 0. Alternatively, this pin (TX_D3_P) can function as part of the LVDS 6-bit Tx differential input bus with internal LVDS termination. |
| D9 | I/O | P0_D5/TX_D2_P | Digital Data Port P0/Transmit Differential Input Bus. This is a dual function pin. As P0_D5, it functions as part of the 12-bit, bidirectional, parallel CMOS level Data Port 0. Alternatively, this pin (TX_D2_P) can function as part of the LVDS 6-bit Tx differential input bus with internal LVDS termination. |
| D10 | I/O | P0_D3/TX_D1_P | Digital Data Port P0/Transmit Differential Input Bus. This is a dual function pin. As P0_D3, it functions as part of the 12-bit, bidirectional, parallel CMOS level Data Port 0. Alternatively, this pin (TX_D1_P) can function as part of the LVDS 6-bit Tx differential input bus with internal LVDS termination. |
| D11 | I/O | P0_D1/TX_D0_P | Digital Data Port P0/Transmit Differential Input Bus. This is a dual function pin. As P0_D1, it functions as part of the 12-bit bidirectional parallel CMOS level Data Port 0. Alternatively, this pin (TX_D0_P) can function as part of the LVDS 6-bit Tx differential input bus with internal LVDS termination. |
| D12, F7, F9, F11, G12, H7, H10, K12 | I | VSSD | Digital Ground. Tie these pins directly to the VSSA analog ground on the printed circuit board (one ground plane). |
| E2 | I | VDDA1P3_RX_LO | Receive LO 1.3 V Supply Input. |
| E3 | I | VDDA1P3_TX_LO_BUFFER | 1.3 V Supply Input. |
| E7 | I/O | P0_D11/TX_D5_P | Digital Data Port P0/Transmit Differential Input Bus. This is a dual function pin. As P0_D11, it functions as part of the 12-bit, bidirectional, parallel CMOS level Data Port 0. Alternatively, this pin (TX_D5_P) can function as part of the LVDS 6-bit Tx differential input bus with internal LVDS termination. |
| E8 | I/O | P0_D8/TX_D4_N | Digital Data Port P0/Transmit Differential Input Bus. This is a dual function pin. As P0_D8, it functions as part of the 12-bit, bidirectional, parallel CMOS level Data Port 0. Alternatively, this pin (TX_D4_N) can function as part of the LVDS 6-bit Tx differential input bus with internal LVDS termination. |
| E9 | I/O | P0_D6/TX_D3_N | Digital Data Port P0/Transmit Differential Input Bus. This is a dual function pin. As P0_D6, it functions as part of the 12-bit, bidirectional, parallel CMOS level Data Port 0. Alternatively, this pin (TX_D3_N) can function as part of the LVDS 6-bit Tx differential input bus with internal LVDS termination. |
| E10 | I/O | P0_D4/TX_D2_N | Digital Data Port P0/Transmit Differential Input Bus. This is a dual function pin. As P0_D4, it functions as part of the 12-bit, bidirectional, parallel CMOS level Data Port 0. Alternatively, this pin (TX_D2_N) can function as part of the LVDS 6-bit Tx differential input bus with internal LVDS termination. |
| E11 | I/O | P0_D2/TX_D1_N | Digital Data Port P0/Transmit Differential Input Bus. This is a dual function pin. As P0_D2, it functions as part of the 12-bit, bidirectional, parallel CMOS level Data Port 0. Alternatively, this pin (TX_D1_N) can function as part of the LVDS 6-bit Tx differential input bus with internal LVDS termination. |
| E12 | I/O | P0_D0/TX_D0_N | Digital Data Port P0/Transmit Differential Input Bus. This is a dual function pin. As P0_D0, it functions as part of the 12-bit, bidirectional, parallel CMOS level Data Port 0. Alternatively, this pin (TX_D0_N) can function as part of the LVDS 6-bit Tx differential input bus with internal LVDS termination. |
| F2 | I | VDDA1P3_RX_VCO_LDO | Receive VCO LDO 1.3 V Supply Input. Connect F2 to E2. |

| Pin No. | Type ¹ | Mnemonic | Description |
|----------|-------------------|------------------------|--|
| F8 | I/O | P0_D10/TX_D5_N | Digital Data Port P0/Transmit Differential Input Bus. This is a dual function pin. As P0_D10, it functions as part of the 12-bit, bidirectional, parallel CMOS level Data Port 0. Alternatively, this pin (TX_D5_N) can function as part of the LVDS 6-bit Tx differential input bus with internal LVDS termination. |
| F10, G10 | I | FB_CLK_P, FB_CLK_N | Feedback Clock. These pins receive the FB_CLK signal that clocks in Tx data. In CMOS mode, use FB_CLK_P as the input and tie FB_CLK_N to ground. |
| F12 | I | VDDD1P3_DIG | 1.3 V Digital Supply Input. |
| G1 | I | RX_EXT_LO_IN | External Receive LO Input. When this pin is unused, tie it to ground. |
| G2 | O | RX_VCO_LDO_OUT | Receive VCO LDO Output. Connect this pin directly to G3 and a 1 μ F bypass capacitor in series with a 1 Ω resistor to ground. |
| G3 | I | VDDA1P1_RX_VCO | Receive VCO Supply Input. Connect this pin directly to G2 only. |
| G5 | I | EN_AGC | Manual Control Input for Automatic Gain Control (AGC). |
| G6 | I | ENABLE | Control Input. This pin moves the device through various operational states. |
| G7, G8 | O | RX_FRAME_N, RX_FRAME_P | Receive Digital Data Framing Output Signal. These pins transmit the RX_FRAME signal that indicates whether the Rx output data is valid. In CMOS mode, use RX_FRAME_P as the output and leave RX_FRAME_N unconnected. |
| G9, H9 | I | TX_FRAME_P, TX_FRAME_N | Transmit Digital Data Framing Input Signal. These pins receive the TX_FRAME signal that indicates when Tx data is valid. In CMOS mode, use TX_FRAME_P as the input and tie TX_FRAME_N to ground. |
| G11, H11 | O | DATA_CLK_P, DATA_CLK_N | Receive Data Clock Output. These pins transmit the DATA_CLK signal that is used by the BBP to clock Rx data. In CMOS mode, use DATA_CLK_P as the output and leave DATA_CLK_N unconnected. |
| H1, J1 | I | RXB_P, RXB_N | Receive Channel Differential Input B. Alternatively, each pin can be used as a single-ended input. These inputs experience degraded performance above 3 GHz. Unused pins must be tied to ground. |
| H4 | I | TXNRX | Enable State Machine Control Signal. This pin controls the data port bus direction. Logic low selects the Rx direction; logic high selects the Tx direction. |
| H5 | I | SYNC_IN | Input to Synchronize Digital Clocks Between Multiple AD9364 Devices. If this pin is unused, it must be tied to ground. |
| H8 | I/O | P1_D11/RX_D5_P | Digital Data Port P1/Receive Differential Output Bus. This is a dual function pin. As P1_D11, it functions as part of the 12-bit bidirectional parallel CMOS level Data Port 1. Alternatively, this pin (RX_D5_P) can function as part of the LVDS 6-bit Rx differential output bus with internal LVDS termination. |
| H12 | I | VDD_INTERFACE | 1.2 V to 2.5 V Supply for Digital I/O Pins (1.8 V to 2.5 V in LVDS Mode). |
| J3 | I | VDDA1P3_RX_SYNTN | 1.3 V Supply Input. |
| J4 | I | SPI_DI | SPI Serial Data Input. |
| J5 | I | SPI_CLK | SPI Clock Input. |
| J6 | O | CLK_OUT | Output Clock. This pin can be configured to output either a buffered version of the external input clock, the DCXO, or a divided-down version of the internal ADC_CLK. |
| J7 | I/O | P1_D10/RX_D5_N | Digital Data Port P1/Receive Differential Output Bus. This is a dual function pin. As P1_D10, it functions as part of the 12-bit bidirectional parallel CMOS level Data Port 1. Alternatively, this pin (RX_D5_N) can function as part of the LVDS 6-bit Rx differential output bus with internal LVDS termination. |
| J8 | I/O | P1_D9/RX_D4_P | Digital Data Port P1/Receive Differential Output Bus. This is a dual function pin. As P1_D9, it functions as part of the 12-bit bidirectional parallel CMOS level Data Port 1. Alternatively, this pin (RX_D4_P) can function as part of the LVDS 6-bit Rx differential output bus with internal LVDS termination. |
| J9 | I/O | P1_D7/RX_D3_P | Digital Data Port P1/Receive Differential Output Bus. This is a dual function pin. As P1_D7, it functions as part of the 12-bit bidirectional parallel CMOS level Data Port 1. Alternatively, this pin (RX_D3_P) can function as part of the LVDS 6-bit Rx differential output bus with internal LVDS termination. |
| J10 | I/O | P1_D5/RX_D2_P | Digital Data Port P1/Receive Differential Output Bus. This is a dual function pin. As P1_D5, it functions as part of the 12-bit bidirectional parallel CMOS level Data Port 1. Alternatively, this pin (RX_D2_P) can function as part of the LVDS 6-bit Rx differential output bus with internal LVDS termination. |
| J11 | I/O | P1_D3/RX_D1_P | Digital Data Port P1/Receive Differential Output Bus. This is a dual function pin. As P1_D3, it functions as part of the 12-bit bidirectional parallel CMOS level Data Port 1. Alternatively, this pin (RX_D1_P) can function as part of the LVDS 6-bit Rx differential output bus with internal LVDS termination. |

| Pin No. | Type ¹ | Mnemonic | Description |
|----------|-------------------|------------------|--|
| J12 | I/O | P1_D1/RX_D0_P | Digital Data Port P1/Receive Differential Output Bus. This is a dual function pin. As P1_D1, it functions as part of the 12-bit bidirectional parallel CMOS level Data Port 1. Alternatively, this pin (RX_D0_P) can function as part of the LVDS 6-bit Rx differential output bus with internal LVDS termination. |
| K1, L1 | I | RXC_P, RXC_N | Receive Channel Differential Input C. Alternatively, each pin can be used as a single-ended input. These inputs experience degraded performance above 3 GHz. Unused pins must be tied to ground. |
| K3 | I | VDDA1P3_TX_SYNTH | 1.3 V Supply Input. |
| K4 | I | VDDA1P3_BB | 1.3 V Supply Input. |
| K5 | I | RESETB | Asynchronous Reset. Logic low resets the device. |
| K6 | I | SPI_ENB | SPI Enable Input. Set this pin to logic low to enable the SPI bus. |
| K7 | I/O | P1_D8/RX_D4_N | Digital Data Port P1/Receive Differential Output Bus. This is a dual function pin. As P1_D8, it functions as part of the 12-bit bidirectional parallel CMOS level Data Port 1. Alternatively, this pin (RX_D4_N) can function as part of the LVDS 6-bit Rx differential output bus with internal LVDS termination. |
| K8 | I/O | P1_D6/RX_D3_N | Digital Data Port P1/Receive Differential Output Bus. This is a dual function pin. As P1_D6, it functions as part of the 12-bit bidirectional parallel CMOS level Data Port 1. Alternatively, this pin (RX_D3_N) can function as part of the LVDS 6-bit Rx differential output bus with internal LVDS termination. |
| K9 | I/O | P1_D4/RX_D2_N | Digital Data Port P1/Receive Differential Output Bus. This is a dual function pin. As P1_D4, it functions as part of the 12-bit bidirectional parallel CMOS level Data Port 1. Alternatively, this pin (RX_D2_N) can function as part of the LVDS 6-bit Rx differential output bus with internal LVDS termination. |
| K10 | I/O | P1_D2/RX_D1_N | Digital Data Port P1/Receive Differential Output Bus. This is a dual function pin. As P1_D2, it functions as part of the 12-bit bidirectional parallel CMOS level Data Port 1. Alternatively, this pin (RX_D1_N) can function as part of the LVDS 6-bit Rx differential output bus with internal LVDS termination. |
| K11 | I/O | P1_D0/RX_D0_N | Digital Data Port P1/Receive Differential Output Bus. This is a dual function pin. As P1_D0, it functions as part of the 12-bit bidirectional parallel CMOS level Data Port 1. Alternatively, this pin (RX_D0_N) can function as part of the LVDS 6-bit Rx differential output bus with internal LVDS termination. |
| L4 | I | RBIAS | Bias Input Reference. Connect this pin through a 14.3 kΩ (1% tolerance) resistor to ground. |
| L5 | I | AUXADC | Auxiliary ADC Input. If this pin is unused, tie it to ground. |
| L6 | O | SPI_DO | SPI Serial Data Output in 4-Wire Mode, High-Z in 3-Wire Mode. |
| M1, M2 | I | RXA_P, RXA_N | Receive Channel Differential Input A. Alternatively, each pin can be used as a single-ended input. Unused pins must be tied to ground. |
| M5 | I | TX_MON | Transmit Channel Power Monitor Input. If this pin is unused, tie it to ground. |
| M7, M8 | O | TXA_P, TXA_N | Transmit Channel Differential Output A. Unused pins must be tied to 1.3 V. |
| M9, M10 | O | TXB_P, TXB_N | Transmit Channel Differential Output B. Unused pins must be tied to 1.3 V. |
| M11, M12 | I | XTALP, XTALN | Reference Frequency Crystal Connections. When a crystal is used, connect it between these two pins. When an external clock source is used, connect it to XTALN and leave XTALP unconnected. |

¹ I is input, O is output, I/O is input/output, NC is not connected.

TYPICAL PERFORMANCE CHARACTERISTICS

800 MHz FREQUENCY BAND



Figure 3. Rx Noise Figure vs. Frequency

11846-003

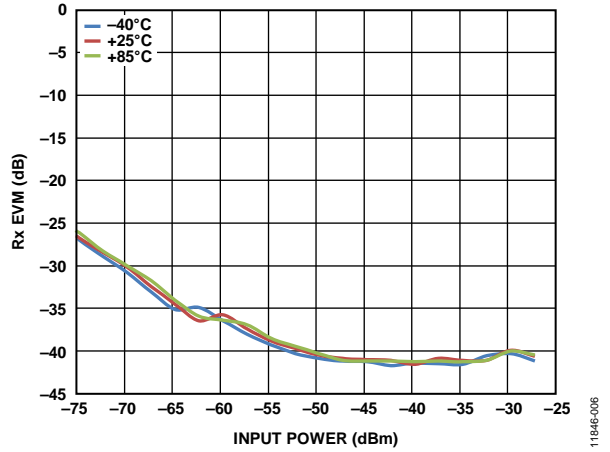

Figure 6. Rx EVM vs. Input Power, 64 QAM LTE 10 MHz Mode, 19.2 MHz REF_CLK

11846-006

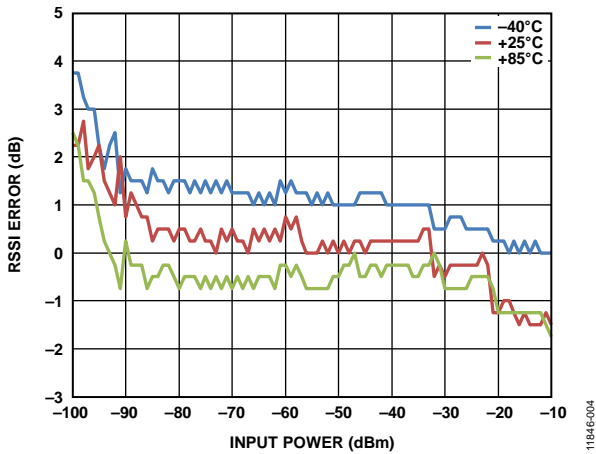

Figure 4. RSSI Error vs. Input Power, LTE 10 MHz Modulation (Referenced to -50 dBm Input Power at 800 MHz)

11846-004

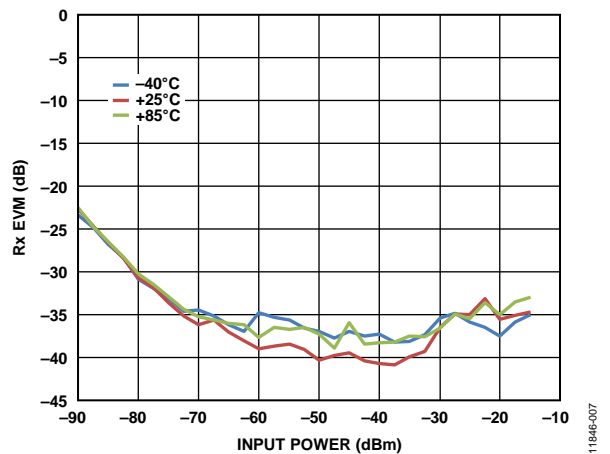

Figure 7. Rx EVM vs. Input Power, GSM Mode, 30.72 MHz REF_CLK (Doubled Internally for RF Synthesizer)

11846-007

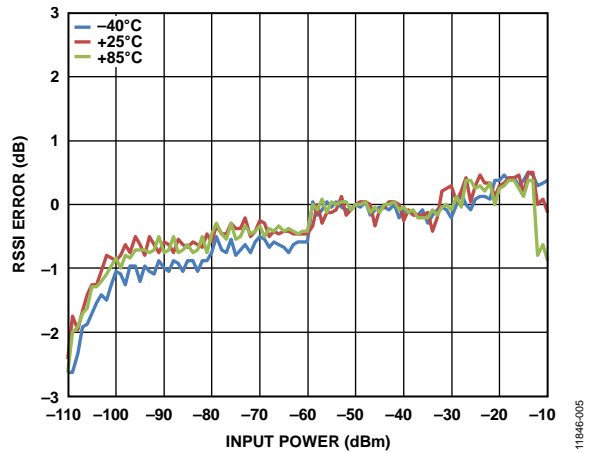

Figure 5. RSSI Error vs. Input Power, EDGE Modulation (Referenced to -50 dBm Input Power at 800 MHz)

11846-005

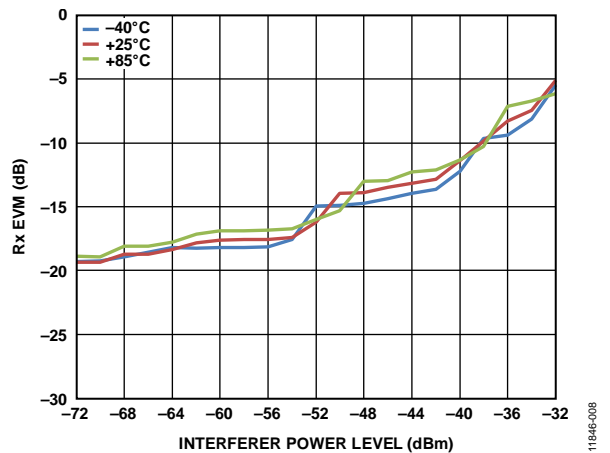

Figure 8. Rx EVM vs. Interferer Power Level, LTE 10 MHz Signal of Interest with $P_{IN} = -82$ dBm, 5 MHz OFDM Blocker at 7.5 MHz Offset

11846-008

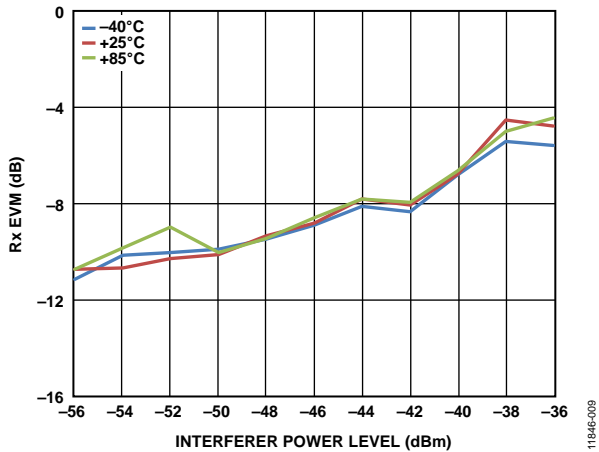

Figure 9. Rx EVM vs. Interferer Power Level, LTE 10 MHz Signal of Interest with $P_{IN} = -90$ dBm, 5 MHz OFDM Blocker at 17.5 MHz Offset

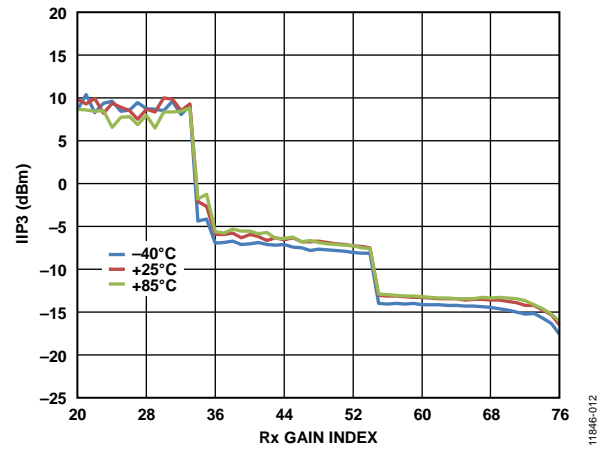

Figure 12. Third-Order Input Intercept Point (IIP3) vs. Rx Gain Index, $f_1 = 1.45$ MHz, $f_2 = 2.89$ MHz, GSM Mode

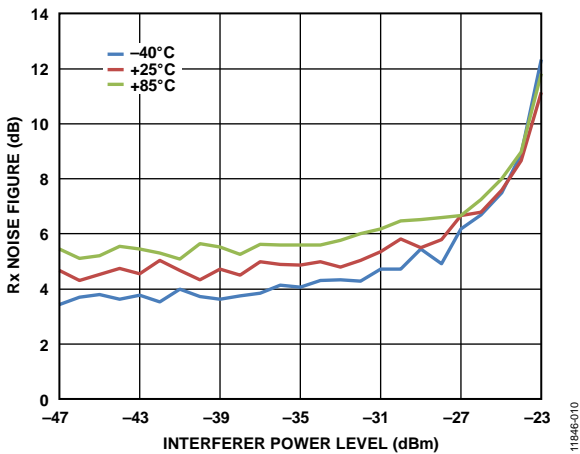

Figure 10. Rx Noise Figure vs. Interferer Power Level, EDGE Signal of Interest with $P_{IN} = -90$ dBm, CW Blocker at 3 MHz Offset, Gain Index = 64

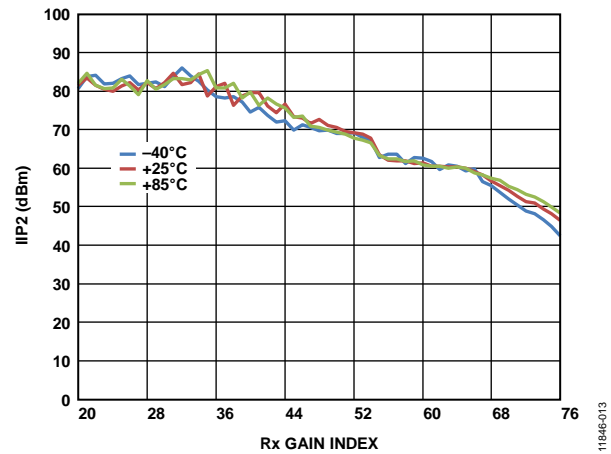

Figure 13. Second-Order Input Intercept Point (IIP2) vs. Rx Gain Index, $f_1 = 2.00$ MHz, $f_2 = 2.01$ MHz, GSM Mode

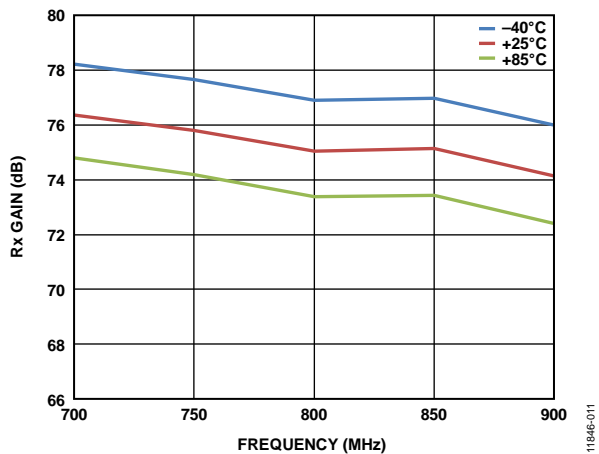

Figure 11. Rx Gain vs. Frequency, Gain Index = 76 (Maximum Setting)

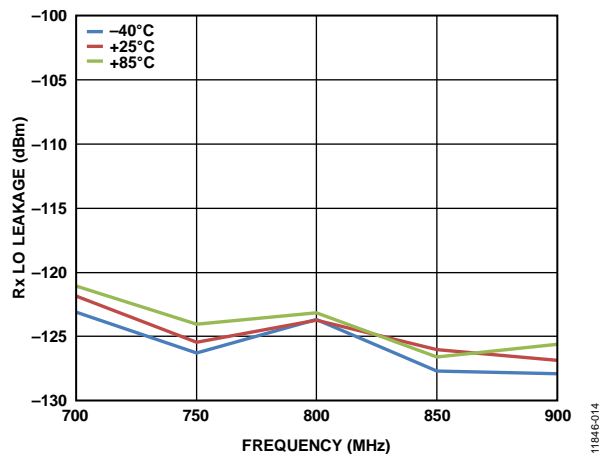

Figure 14. Rx Local Oscillator (LO) Leakage vs. Frequency

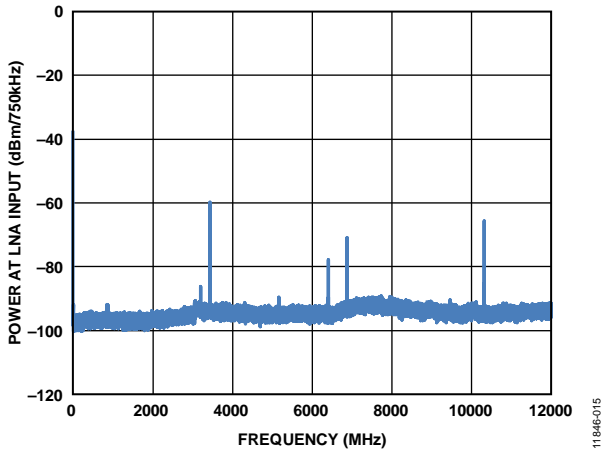

Figure 15. Rx Emission at LNA Input, DC to 12 GHz, $f_{LO_RX} = 800$ MHz, LTE 10 MHz, $f_{LO_TX} = 860$ MHz

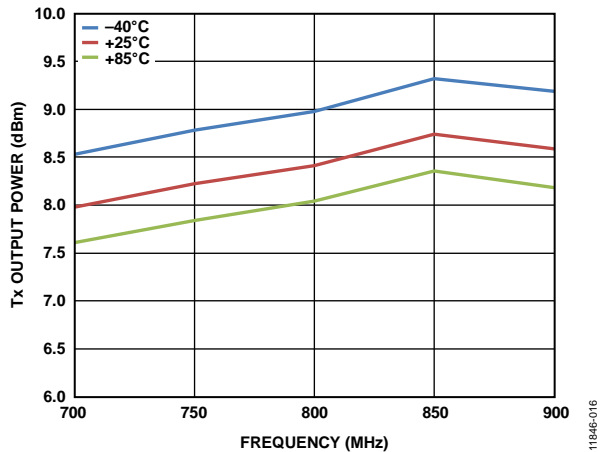

Figure 16. Tx Output Power vs. Frequency, Attenuation Setting = 0 dB, Single Tone Output

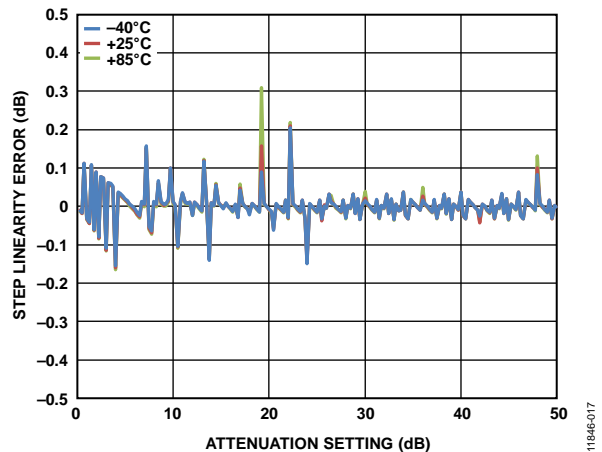

Figure 17. Tx Power Control Linearity Error vs. Attenuation Setting

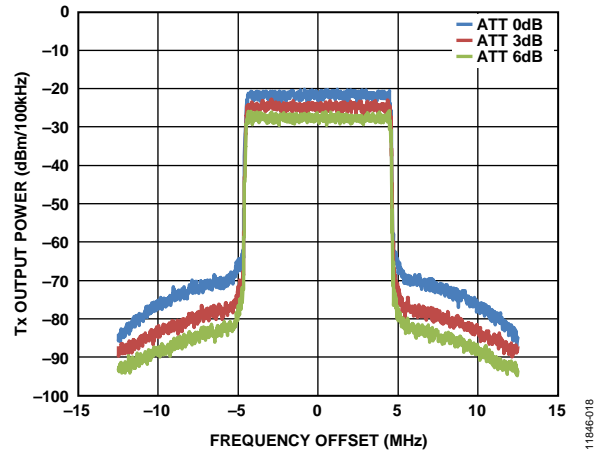

Figure 18. Tx Spectrum vs. Frequency Offset from Carrier Frequency, $f_{LO_TX} = 800$ MHz, LTE 10 MHz Downlink (Digital Attenuation Variations Shown)

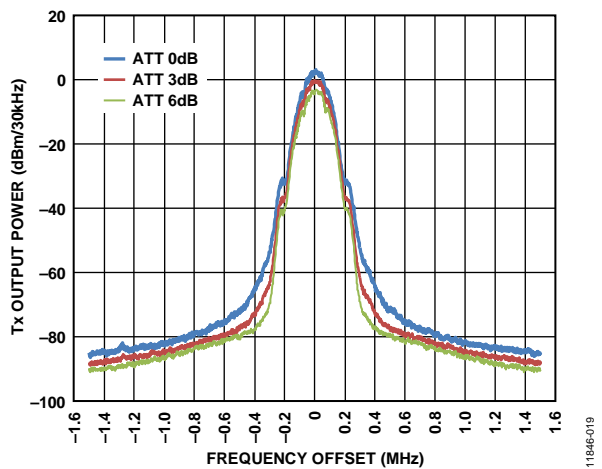

Figure 19. Tx Spectrum vs. Frequency Offset from Carrier Frequency, $f_{LO_TX} = 800$ MHz, GSM Downlink (Digital Attenuation Variations Shown), 3 MHz Range

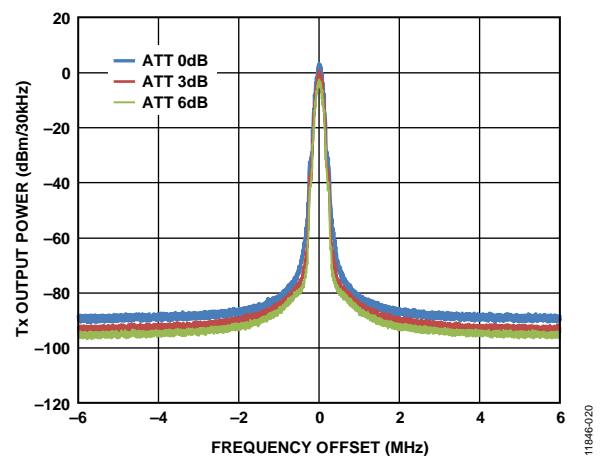

Figure 20. Tx Spectrum vs. Frequency Offset from Carrier Frequency, $f_{LO_TX} = 800$ MHz, GSM Downlink (Digital Attenuation Variations Shown), 12 MHz Range



Figure 21. Tx EVM vs. Transmitter Attenuation Setting, $f_{LO_TX} = 800$ MHz, LTE 10 MHz, 64 QAM Modulation, 19.2 MHz REF_CLK

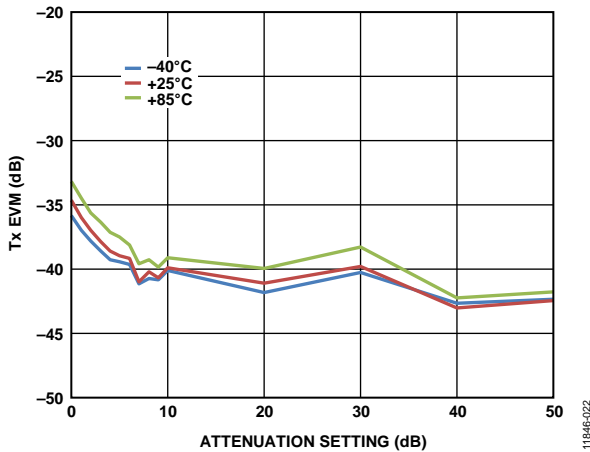

Figure 22. Tx EVM vs. Transmitter Attenuation Setting, $f_{LO_TX} = 800$ MHz, GSM Modulation, 30.72 MHz REF_CLK (Doubled Internally for RF Synthesizer)

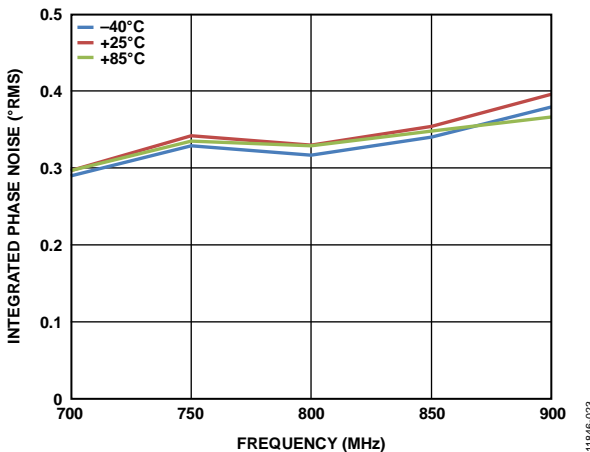

Figure 23. Integrated Tx LO Phase Noise vs. Frequency, 19.2 MHz REF_CLK

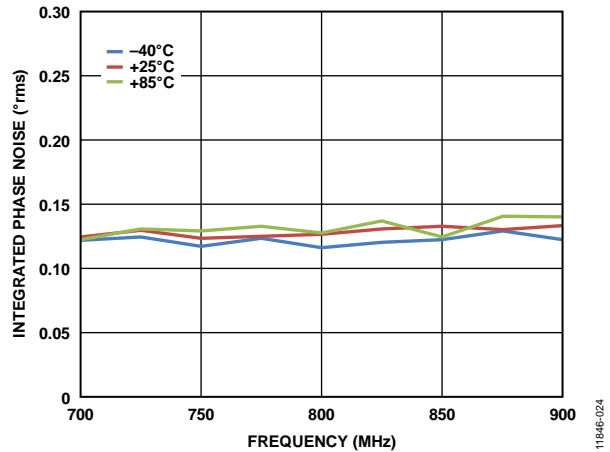

Figure 24. Integrated Tx LO Phase Noise vs. Frequency, 30.72 MHz REF_CLK (Doubled Internally for RF Synthesizer)

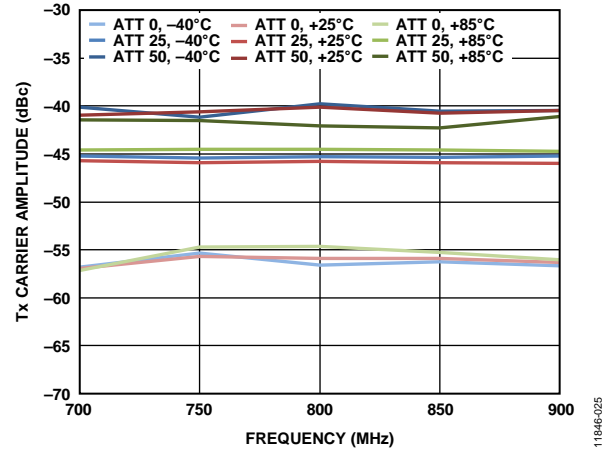

Figure 25. Tx Carrier Rejection vs. Frequency

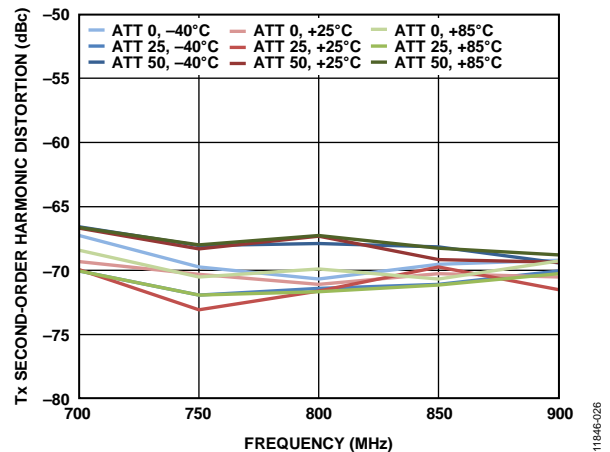

Figure 26. Tx Second-Order Harmonic Distortion (HD2) vs. Frequency

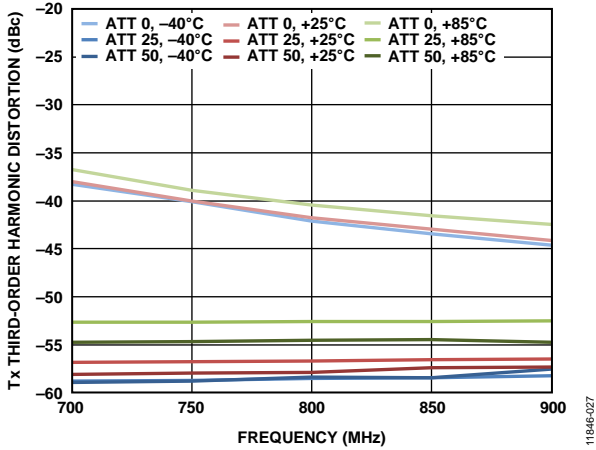

Figure 27. Tx Third-Order Harmonic Distortion (HD3) vs. Frequency

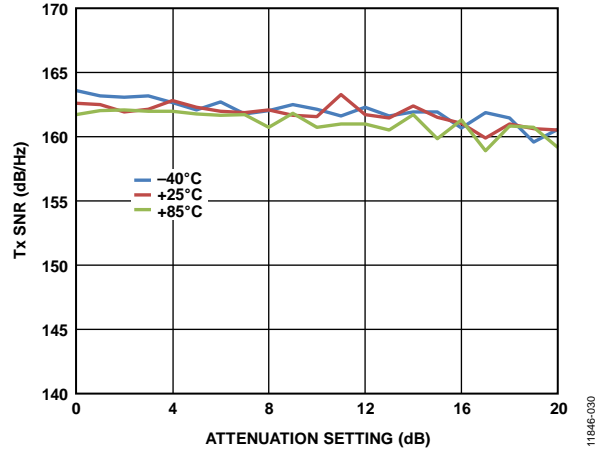

Figure 30. Tx Signal-to-Noise Ratio (SNR) vs. Transmitter Attenuation Setting, GSM Signal of Interest with Noise Measured at 20 MHz Offset



Figure 28. Tx Third-Order Output Intercept Point (OIP3) vs. Attenuation Setting

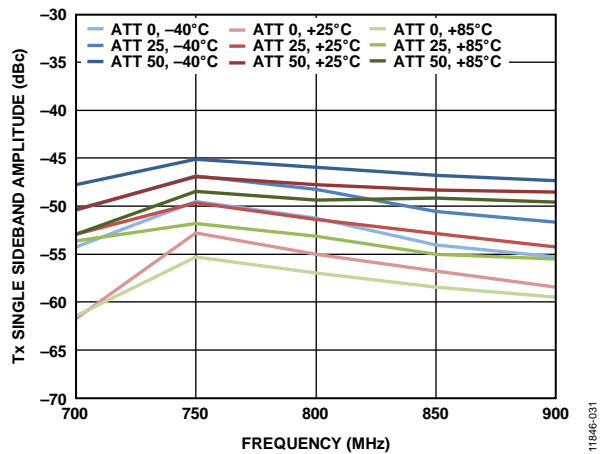

Figure 31. Tx Single Sideband (SSB) Rejection vs. Frequency, 1.5375 MHz Offset

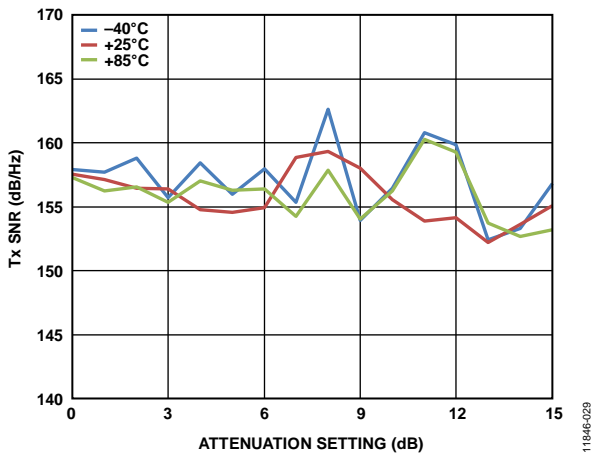

Figure 29. Tx Signal-to-Noise Ratio (SNR) vs. Transmitter Attenuation Setting, LTE 10 MHz Signal of Interest with Noise Measured at 90 MHz Offset

2.4 GHZ FREQUENCY BAND



Figure 32. Rx Noise Figure vs. Frequency

11946-032

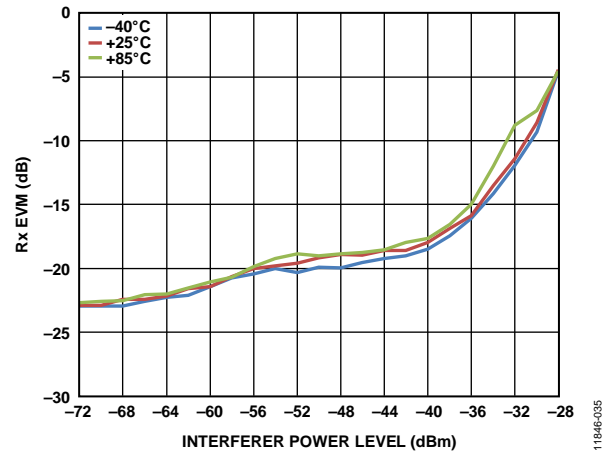

Figure 35. Rx EVM vs. Interferer Power Level, LTE 20 MHz Signal of Interest with $P_{IN} = -75$ dBm, LTE 20 MHz Blocker at 20 MHz Offset

11946-035

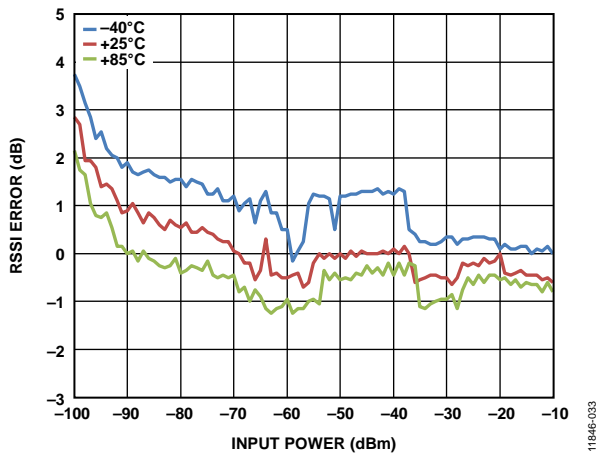

Figure 33. RSSI Error vs. Input Power, Referenced to -50 dBm Input Power at 2.4 GHz

11946-033

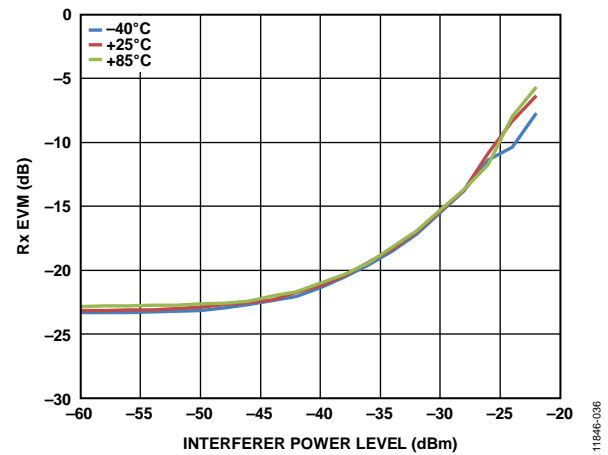

Figure 36. Rx EVM vs. Interferer Power Level, LTE 20 MHz Signal of Interest with $P_{IN} = -75$ dBm, LTE 20 MHz Blocker at 40 MHz Offset

11946-036

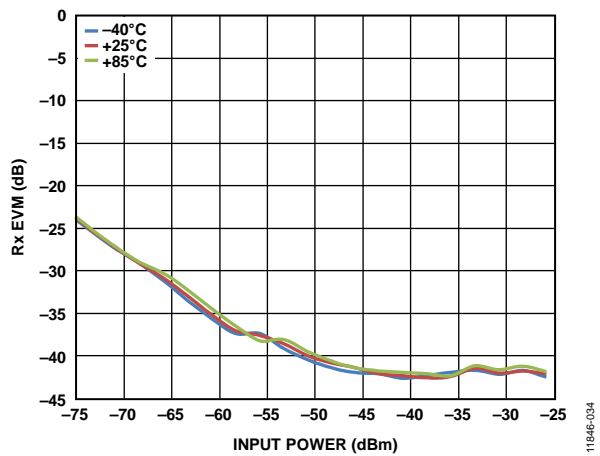

Figure 34. Rx EVM vs. Input Power, 64 QAM LTE 20 MHz Mode, 40 MHz REF_CLK

11946-034

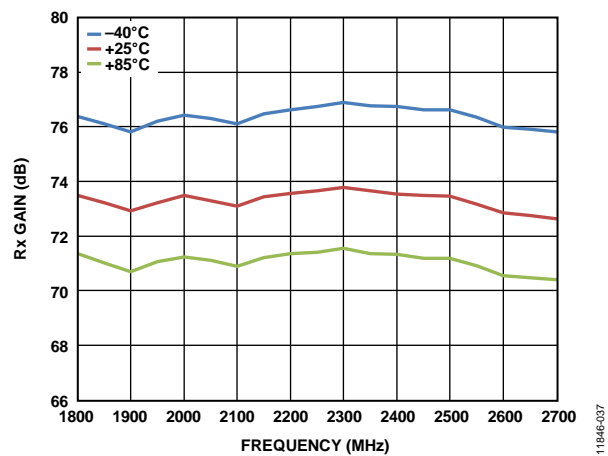

Figure 37. Rx Gain vs. Frequency, Gain Index = 76 (Maximum Setting)

11946-037

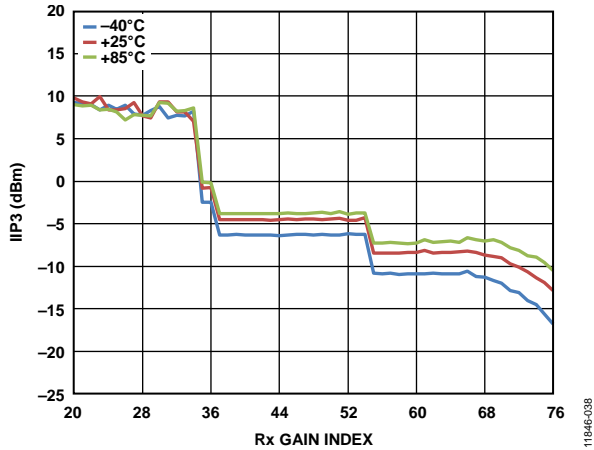

Figure 38. Third-Order Input Intercept Point (IIP3) vs. Rx Gain Index, $f_1 = 30$ MHz, $f_2 = 61$ MHz

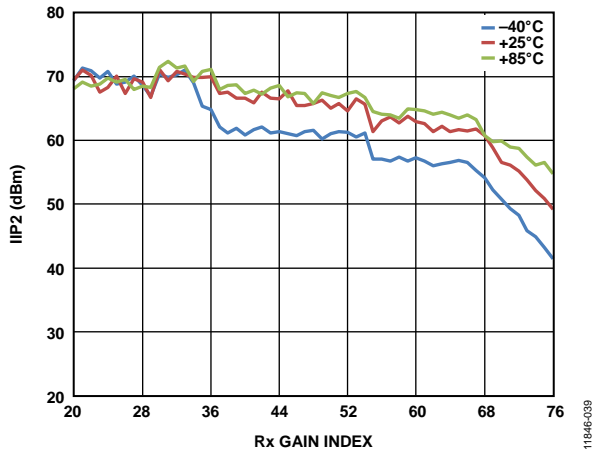

Figure 39. Second-Order Input Intercept Point (IIP2) vs. Rx Gain Index, $f_1 = 60$ MHz, $f_2 = 61$ MHz

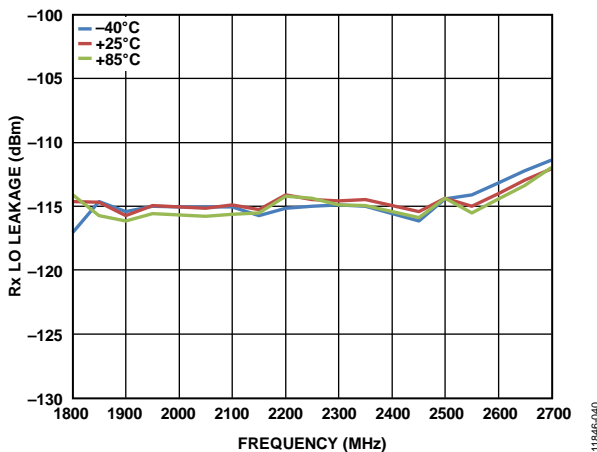

Figure 40. Rx Local Oscillator (LO) Leakage vs. Frequency

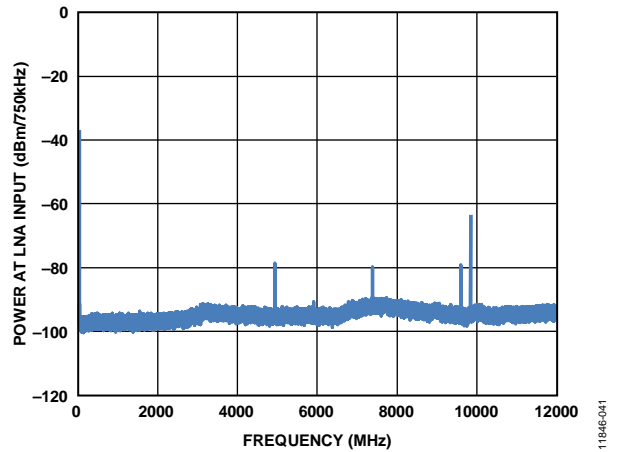

Figure 41. Rx Emission at LNA Input, DC to 12 GHz, $f_{LO_RX} = 2.4$ GHz, LTE 20 MHz, $f_{LO_TX} = 2.46$ GHz

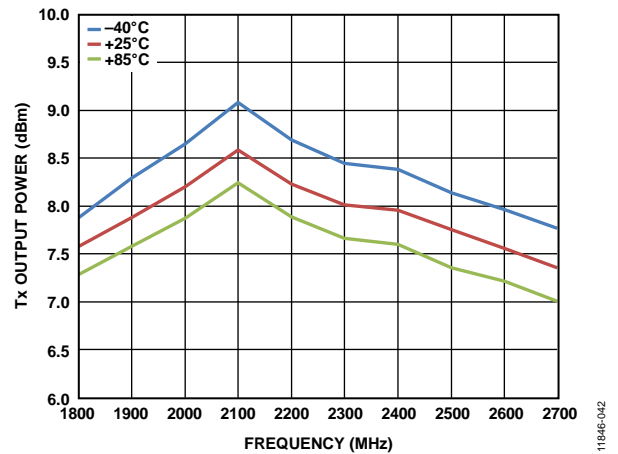

Figure 42. Tx Output Power vs. Frequency, Attenuation Setting = 0 dB, Single Tone Output

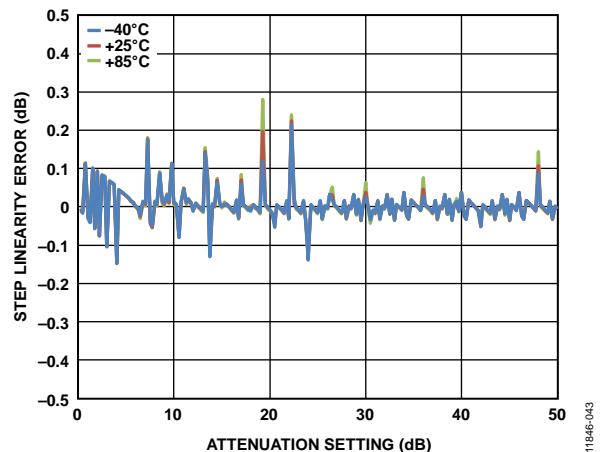

Figure 43. Tx Power Control Linearity Error vs. Attenuation Setting



Figure 44. Tx Spectrum vs. Frequency Offset from Carrier Frequency, $f_{LO_TX} = 2.3$ GHz, LTE 20 MHz Downlink (Digital Attenuation Variations Shown)



Figure 47. Tx Carrier Rejection vs. Frequency

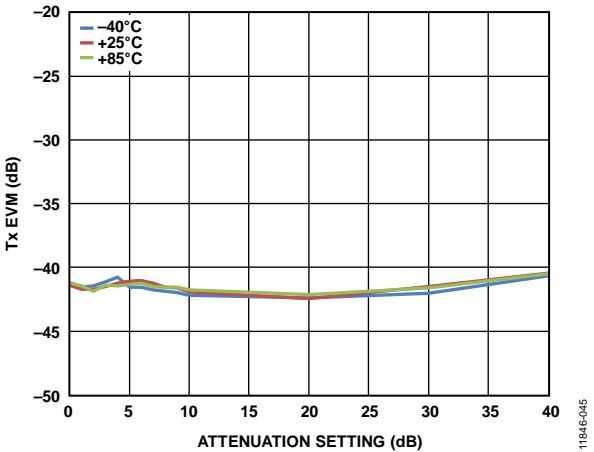

Figure 45. Tx EVM vs. Transmitter Attenuation Setting, 40 MHz REF_CLK, LTE 20 MHz, 64 QAM Modulation

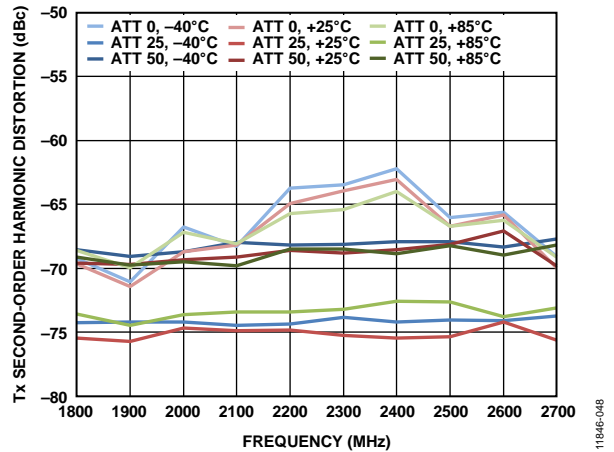

Figure 48. Tx Second-Order Harmonic Distortion (HD2) vs. Frequency

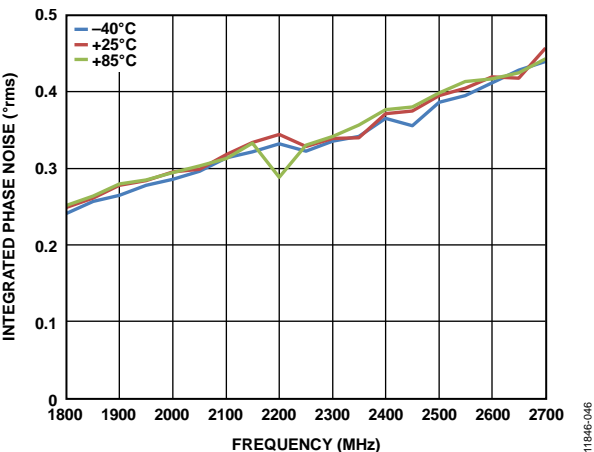

Figure 46. Integrated Tx LO Phase Noise vs. Frequency, 40 MHz REF_CLK

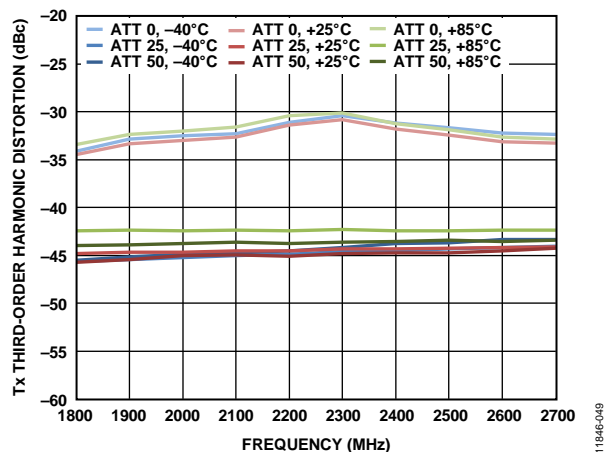

Figure 49. Tx Third-Order Harmonic Distortion (HD3) vs. Frequency

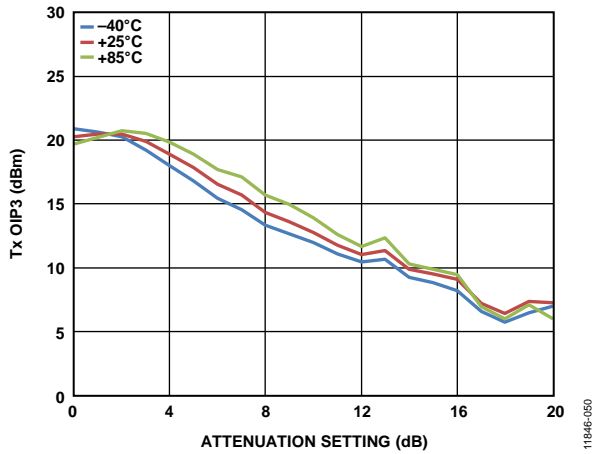

Figure 50. Tx Third-Order Output Intercept Point (OIP3) vs. Attenuation Setting

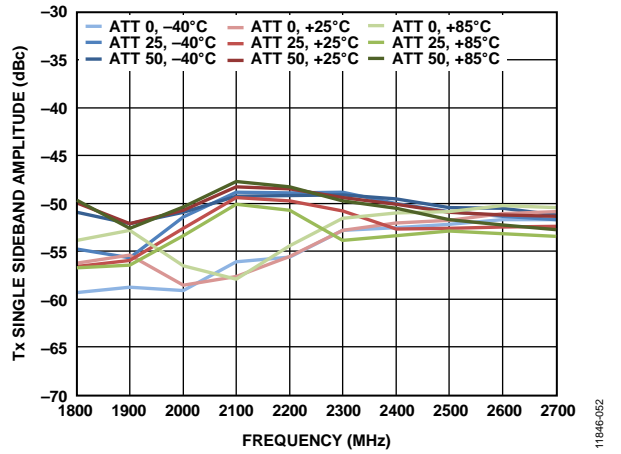

Figure 52. Tx Single Sideband (SSB) Rejection vs. Frequency, 3.075 MHz Offset



Figure 51. Tx Signal-to-Noise Ratio (SNR) vs. Transmitter Attenuation Setting, LTE 20 MHz Signal of Interest with Noise Measured at 90 MHz Offset

5.5 GHZ FREQUENCY BAND

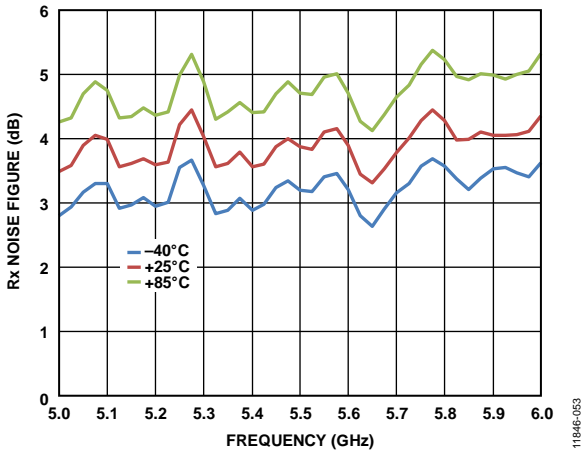

Figure 53. Rx Noise Figure vs. Frequency

11846-053

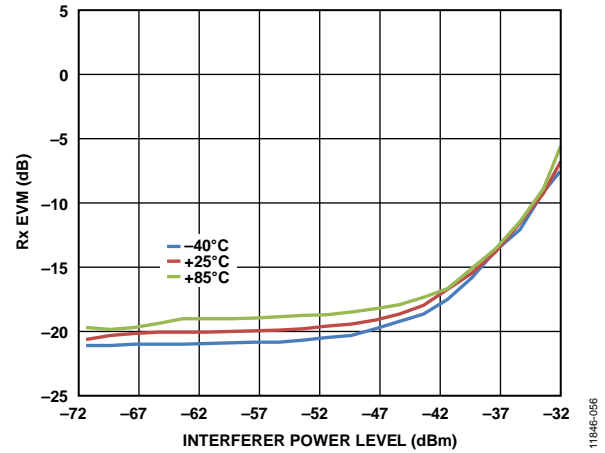

Figure 56. Rx EVM vs. Interferer Power Level, WiMAX 40 MHz Signal of Interest with $P_{IN} = -74$ dBm, WiMAX 40 MHz Blocker at 40 MHz Offset

11846-056

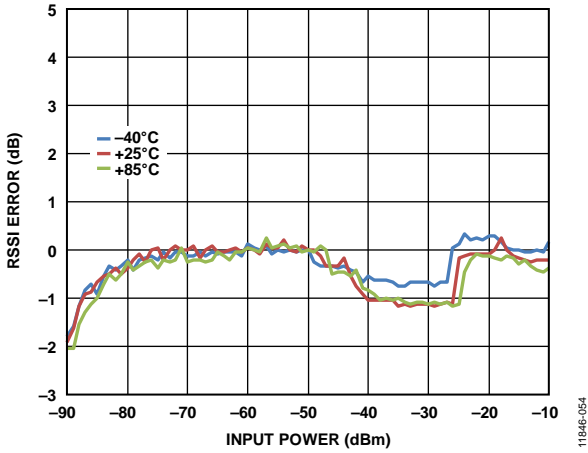

Figure 54. RSSI Error vs. Input Power, Referenced to -50 dBm Input Power at 5.8 GHz

11846-054

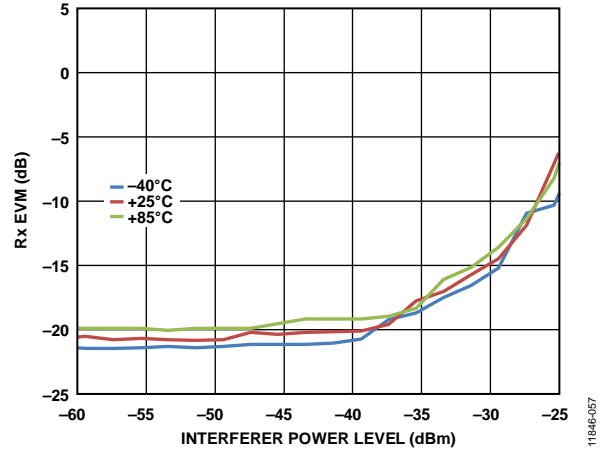

Figure 57. Rx EVM vs. Interferer Power Level, WiMAX 40 MHz Signal of Interest with $P_{IN} = -74$ dBm, WiMAX 40 MHz Blocker at 80 MHz Offset

11846-057

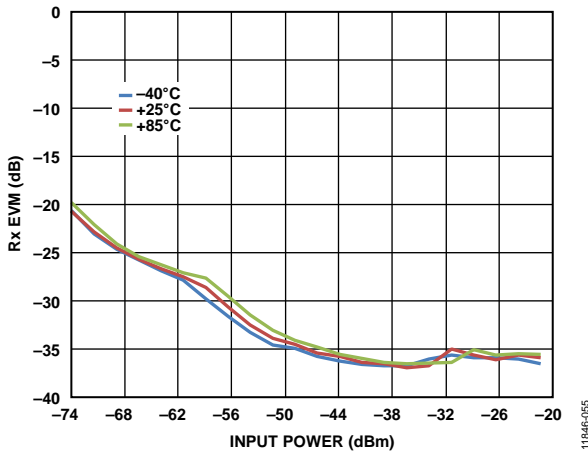

Figure 55. Rx EVM vs. Input Power, 64 QAM WiMAX 40 MHz Mode, 40 MHz REF_CLK (Doubled Internally for RF Synthesizer)

11846-055

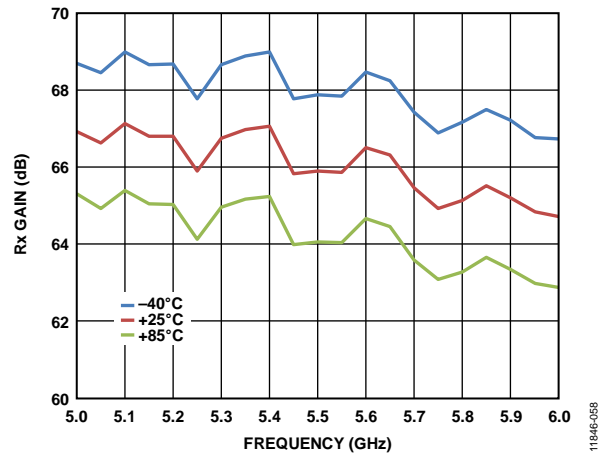

Figure 58. Rx Gain vs. Frequency, Gain Index = 76 (Maximum Setting)

11846-058

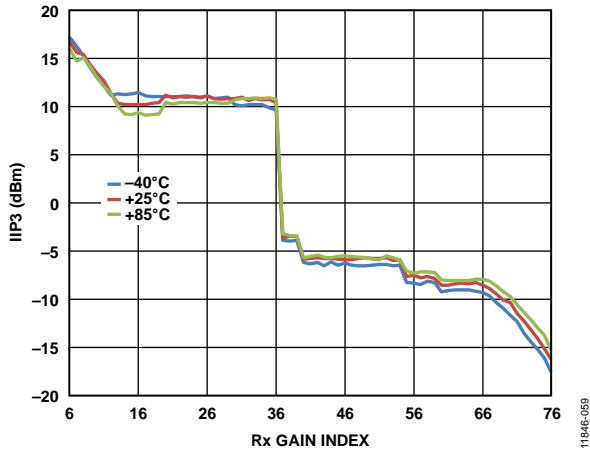

Figure 59. Third-Order Input Intercept Point (IIP3) vs. Rx Gain Index, $f_1 = 50$ MHz, $f_2 = 101$ MHz

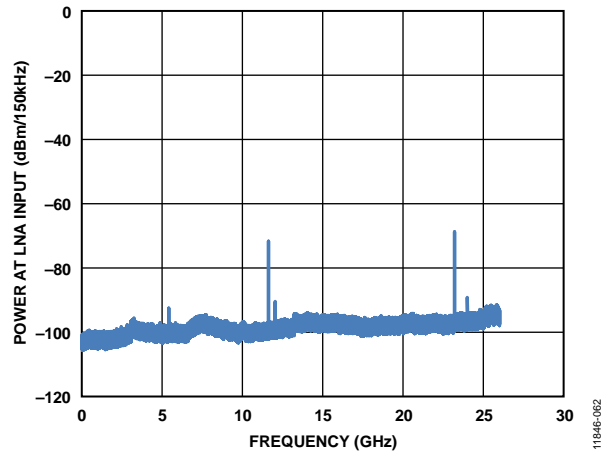

Figure 62. Rx Emission at LNA Input, DC to 26 GHz, $f_{LO_RX} = 5.8$ GHz, WiMAX 40 MHz

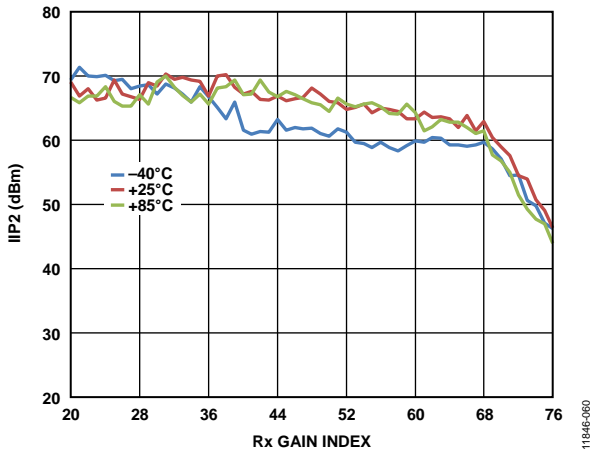

Figure 60. Second-Order Input Intercept Point (IIP2) vs. Rx Gain Index, $f_1 = 70$ MHz, $f_2 = 71$ MHz

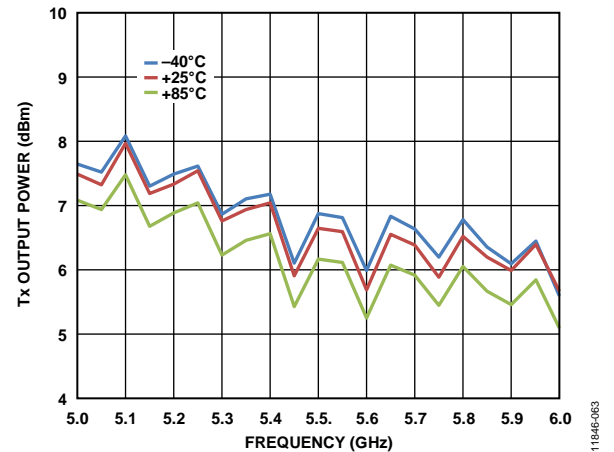

Figure 63. Tx Output Power vs. Frequency, Attenuation Setting = 0 dB, Single Tone

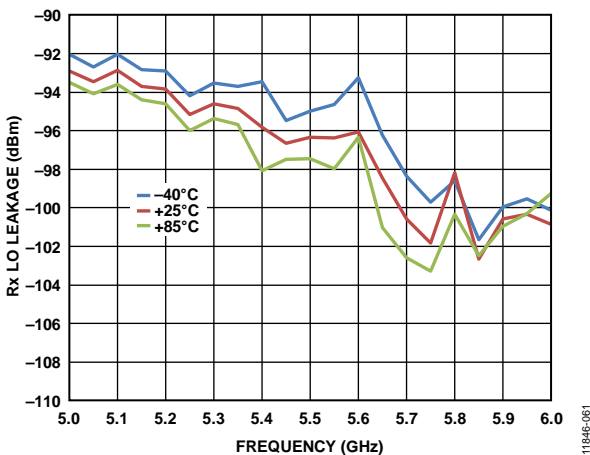

Figure 61. Rx Local Oscillator (LO) Leakage vs. Frequency

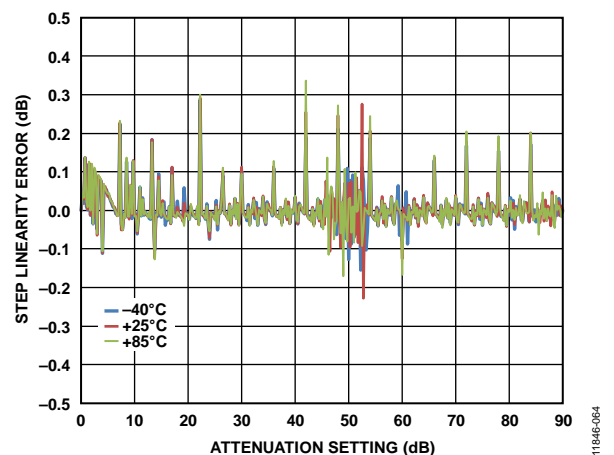

Figure 64. Tx Power Control Linearity Error vs. Attenuation Setting

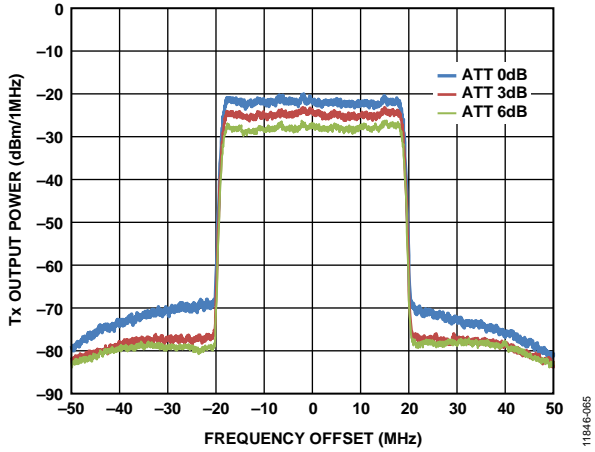

Figure 65. Tx Spectrum vs. Frequency Offset from Carrier Frequency, $f_{LO_TX} = 5.8$ GHz, WiMAX 40 MHz Downlink (Digital Attenuation Variations Shown)

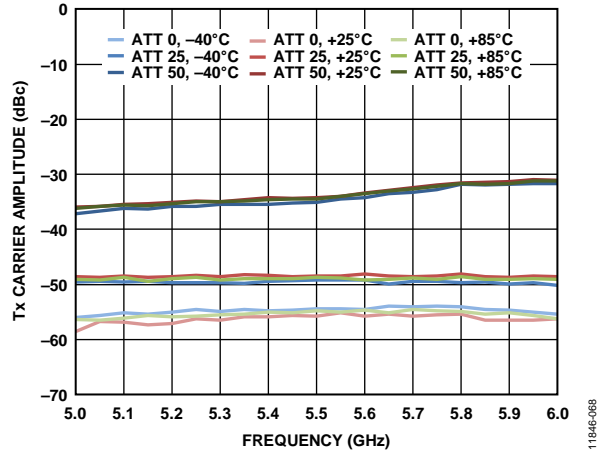

Figure 68. Tx Carrier Rejection vs. Frequency

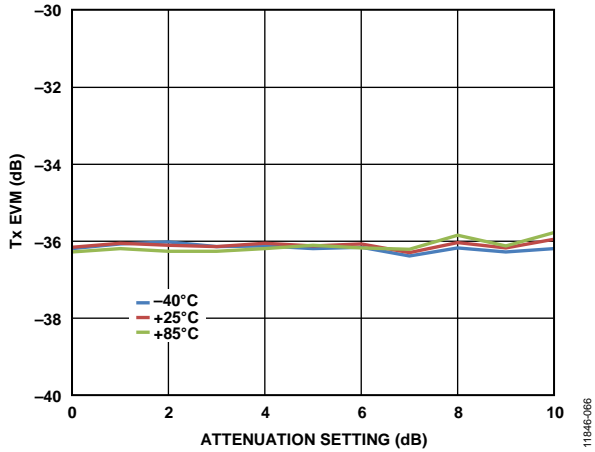

Figure 66. Tx EVM vs. Transmitter Attenuation Setting, WiMAX 40 MHz, 64 QAM Modulation, $f_{LO_TX} = 5.495$ GHz, 40 MHz REF_CLK (Doubled Internally for RF Synthesizer)

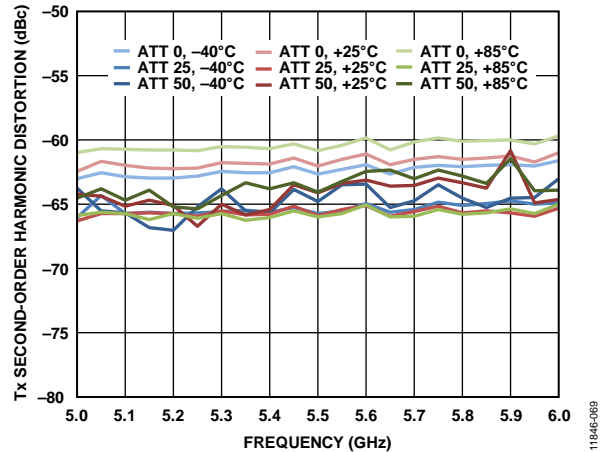

Figure 69. Tx Second-Order Harmonic Distortion (HD2) vs. Frequency

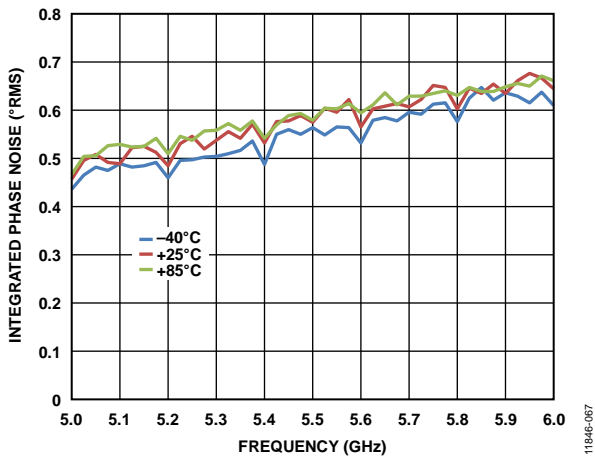

Figure 67. Integrated Tx LO Phase Noise vs. Frequency, 40 MHz REF_CLK (Doubled Internally for RF Synthesizer)

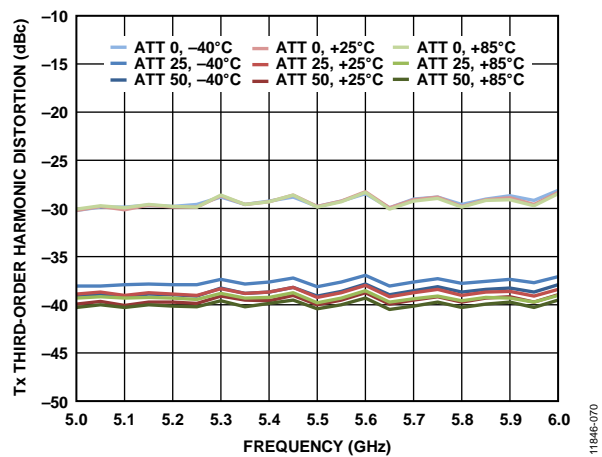

Figure 70. Tx Third-Order Harmonic Distortion (HD3) vs. Frequency



Figure 71. Tx Third-Order Output Intercept Point (OIP3) vs. Attenuation Setting, $f_{LO_TX} = 5.8$ GHz



Figure 73. Tx Single Sideband (SSB) Rejection vs. Frequency, 7 MHz Offset



Figure 72. Tx Signal-to-Noise Ratio (SNR) vs. Transmitter Attenuation Setting, WiMAX 40 MHz Signal of Interest with Noise Measured at 90 MHz Offset, $f_{LO_TX} = 5.745$ GHz

THEORY OF OPERATION

GENERAL

The [AD9364](#) is a highly integrated radio frequency (RF) transceiver capable of being configured for a wide range of applications. The device integrates all RF, mixed signal, and digital blocks necessary to provide all transceiver functions in a single device. Programmability allows this broadband transceiver to be adapted for use with multiple communication standards, including frequency division duplex (FDD) and time division duplex (TDD) systems. This programmability also allows the device to be interfaced to various baseband processors (BBPs) using a single 12-bit parallel data port, dual 12-bit parallel data ports, or a 12-bit low voltage differential signaling (LVDS) interface.

The [AD9364](#) also provides self calibration and automatic gain control (AGC) systems to maintain a high performance level under varying temperatures and input signal conditions. In addition, the device includes several test modes that allow system designers to insert test tones and create internal loopback modes that can be used by designers to debug their designs during prototyping and optimize their radio configuration for a specific application.

RECEIVER

The receiver section contains all blocks necessary to receive RF signals and convert them to digital data that is usable by a BBP. It has three inputs that can be multiplexed to the signal chain, making the [AD9364](#) suitable for use in multiband systems with multiple antenna inputs. The receiver is a direct conversion system that contains a low noise amplifier (LNA), followed by matched in-phase (I) and quadrature (Q) amplifiers, mixers, and band shaping filters that downconvert received signals to baseband for digitization. External LNAs can also be interfaced to the device, allowing designers the flexibility to customize the receiver front end for their specific application.

Gain control is achieved by following a preprogrammed gain index map that distributes gain among the blocks for optimal performance at each level. This can be achieved by enabling the internal AGC in either fast or slow mode or by using manual gain control, allowing the BBP to make the gain adjustments as needed. Additionally, each channel contains independent RSSI measurement capability, dc offset tracking, and all circuitry necessary for self calibration.

The receiver includes 12-bit, Σ - Δ ADCs and adjustable sample rates that produce data streams from the received signals. The digitized signals can be conditioned further by a series of decimation filters and a fully programmable 128-tap FIR filter with additional decimation settings. The sample rate of each digital filter block is adjustable by changing decimation factors to produce the desired output data rate.

TRANSMITTER

The transmitter section consists of two differential output stages that can be multiplexed to the transmit channel. The transmit channel provides all digital processing, mixed signal, and RF blocks necessary to implement a direct conversion system. The digital data received from the BBP passes through a fully programmable 128-tap FIR filter with interpolation options. The FIR output is sent to a series of interpolation filters that provide additional filtering and data rate interpolation prior to reaching the DAC. Each 12-bit DAC has an adjustable sampling rate. Both the I and Q channels are fed to the RF block for upconversion.

When converted to baseband analog signals, the I and Q signals are filtered to remove sampling artifacts and fed to the upconversion mixers. At this point, the I and Q signals are recombined and modulated on the carrier frequency for transmission to the output stage. The combined signal also passes through analog filters that provide additional band shaping, and then the signal is transmitted to the output amplifier. The transmit channel provides a wide attenuation adjustment range with fine granularity to help designers optimize signal-to-noise ratio (SNR).

Self calibration circuitry is built into each transmit channel to provide automatic real-time adjustment. The transmitter block also provides a Tx monitor block. This block monitors the transmitter output and routes it back through the receiver channel to the BBP for signal monitoring. The Tx monitor block is available only in TDD mode operation while the receiver is idle.

CLOCK INPUT OPTIONS

The [AD9364](#) operates using a reference clock that can be provided by two different sources. The first option is to use a dedicated crystal with a frequency between 19 MHz and 50 MHz connected between the XTALP and XTALN pins. The second option is to connect an external oscillator or clock distribution device (such as the [AD9548](#)) to the XTALN pin (with the XTALP pin remaining unconnected). If an external oscillator is used, the frequency can vary between 10 MHz and 80 MHz. This reference clock is used to supply the synthesizer blocks that generate all data clocks, sample clocks, and local oscillators inside the device.

Errors in the crystal frequency can be removed by using the digitally programmable digitally controlled crystal oscillator (DCXO) function to adjust an on-chip variable capacitor. This capacitor can tune the crystal frequency variance out of the system, resulting in a more accurate reference clock from which all other frequency signals are generated. This function can also be used with on-chip temperature sensing to provide oscillator frequency temperature compensation during normal operation.

SYNTHESIZERS

RF PLLs

The AD9364 contains two identical synthesizers to generate the required LO signals for the RF signal paths—one for the receiver and one for the transmitter. Phase-locked loop (PLL) synthesizers are fractional-N designs incorporating completely integrated voltage controlled oscillators (VCOs) and loop filters. In TDD mode, the synthesizers turn on and off as appropriate for the Rx and Tx frames. In FDD mode, the Tx PLL and the Rx PLL can be activated at the same time. These PLLs require no external components.

BB PLL

The AD9364 also contains a baseband PLL (BB PLL) synthesizer that is used to generate all baseband related clock signals. These include the ADC and DAC sampling clocks, the DATA_CLK signal (see the Digital Data Interface section), and all data framing signals. This PLL is programmed from 700 MHz to 1400 MHz based on the data rate and sample rate requirements of the system.

DIGITAL DATA INTERFACE

The AD9364 data interface uses parallel data ports (P0 and P1) to transfer data between the device and the BBP. The data ports can be configured in either single-ended CMOS format or differential LVDS format. Both formats can be configured in multiple arrangements to match system requirements for data ordering and data port connections. These arrangements include single port data bus, dual port data bus, single data rate, and double data rate.

Bus transfers are controlled using simple hardware handshake signaling. The two ports can be operated in either bidirectional (half-duplex) mode or in full duplex mode where half the bits are used for transmitting data and half are used for receiving data. The interface can also be configured to use only one of the data ports for applications that do not require high data rates and prefer to use fewer interface pins.

DATA_CLK Signal

The AD9364 supplies the DATA_CLK signal that the BBP uses when receiving the data. The DATA_CLK signal can be set to a rate that provides single data rate (SDR) timing where data is sampled on each rising clock edge, or it can be set to provide double data rate (DDR) timing where data is captured on both rising and falling edges. SDR or DDR timing applies to operation using either a single port or both ports.

FB_CLK Signal

For transmit data, the interface uses the FB_CLK signal as the timing reference. FB_CLK allows source synchronous timing with rising edge capture for burst control signals and either rising edge (SDR mode) or both edge capture (DDR mode) for transmit signal bursts. The FB_CLK signal must have the same frequency and duty cycle as DATA_CLK.

RX_FRAME Signal

The device generates an RX_FRAME output signal whenever the receiver outputs valid data. This signal has two modes: level mode (RX_FRAME stays high as long as the data is valid) and pulse mode (RX_FRAME pulses with a 50% duty cycle). Similarly, the BBP must provide a TX_FRAME signal that indicates the beginning of a valid data transmission with a rising edge. Similar to the RX_FRAME signal, the TX_FRAME signal can remain high throughout the burst or it can be pulsed with a 50% duty cycle.

ENABLE STATE MACHINE

The AD9364 transceiver includes an enable state machine (ENSM) that allows real-time control over the current state of the device. The device can be placed in several different states during normal operation, including

- Wait—power save, synthesizers disabled
- Sleep—wait with all clocks/BB PLL disabled
- Tx—Tx signal chain enabled
- Rx—Rx signal chain enabled
- FDD—Tx and Rx signal chains enabled
- Alert—synthesizers enabled

The ENSM has two possible control methods: SPI control and pin control.

SPI Control Mode

In SPI control mode, the ENSM is controlled asynchronously by writing SPI registers to advance the current state to the next state. SPI control is considered asynchronous to the DATA_CLK because the SPI_CLK can be derived from a different clock reference and can still function properly. The SPI control ENSM method is recommended when real-time control of the synthesizers is not necessary. SPI control can be used for real-time control as long as the BBP has the ability to perform timed SPI writes accurately.

Pin Control Mode

In pin control mode, the enable function of the ENABLE pin and the TXNRX pin allow real-time control of the current state. The ENSM allows TDD or FDD operation depending on the configuration of the corresponding SPI register. The ENABLE and TXNRX pin control method is recommended if the BBP has extra control outputs that can be controlled in real time, allowing a simple 2-wire interface to control the state of the device. To advance the current state of the ENSM to the next state, the enable function of the ENABLE pin can be driven by either a pulse (edge detected internally) or a level.

When a pulse is used, it must have a minimum pulse width of one FB_CLK cycle. In level mode, the ENABLE and TXNRX pins are also edge detected by the AD9364 and must meet the same minimum pulse width requirement of one FB_CLK cycle.

In FDD mode, the ENABLE and TXNRX pins can be remapped to serve as real-time Rx and Tx data transfer control signals. In this mode, the enable function of the ENABLE pin assumes the RXON

function (controlling when the Rx path is enabled and disabled), and the TXNRX pin assumes the TXON function (controlling when the Tx path is enabled and disabled). In this mode, the ENSM is removed from the system for control of all data flow by these pins.

SPI INTERFACE

The AD9364 uses a serial peripheral interface (SPI) to communicate with the BBP. The SPI can be configured as a 4-wire interface with dedicated receive and transmit ports, or it can be configured as a 3-wire interface with a bidirectional data communication port. This bus allows the BBP to set all device control parameters using a simple address data serial bus protocol.

Write commands follow a 24-bit format. The first six bits are used to set the bus direction and number of bytes to transfer. The next 10 bits set the address where data is to be written. The final eight bits are the data to be transferred to the specified register address (MSB to LSB). The AD9364 also supports an LSB-first format that allows the commands to be written in LSB to MSB format. In this mode, the register addresses are incremented for multibyte writes.

Read commands follow a similar format with the exception that the first 16 bits are transferred on the SPI_DI pin and the final eight bits are read from the AD9364, either on the SPI_DO pin in 4-wire mode or on the SPI_DI pin in 3-wire mode.

CONTROL PINS

Control Outputs (CTRL_OUT7 to CTRL_OUT0)

The AD9364 provides eight simultaneous real-time output signals for use as interrupts to the BBP. These outputs can be configured to output a number of internal settings and measurements that the BBP can use when monitoring transceiver performance in different situations. The control output pointer register selects what information is output to these pins, and the control output enable register determines which signals are activated for monitoring by the BBP. Signals used for manual gain mode, calibration flags, state machine states, and the ADC output are among the outputs that can be monitored on these pins.

Control Inputs (CTRL_IN3 to CTRL_IN0)

The AD9364 provides four edge detected control input pins. In manual gain mode, the BBP can use these pins to change the gain table index in real time. In transmit mode, the BBP can use two of the pins to change the transmit gain in real time.

GPO PINS (GPO_3 TO GPO_0)

The AD9364 provides four, 3.3 V capable general-purpose logic output pins: GPO_3, GPO_2, GPO_1, and GPO_0. These pins can be used to control other peripheral devices such as regulators and switches via the AD9364 SPI bus, or they can function as slaves for the internal AD9364 state machine.

AUXILIARY CONVERTERS

AUXADC

The AD9364 contains an auxiliary ADC that can be used to monitor system functions such as temperature or power output. The converter is 12 bits wide and has an input range of 0.05 V to VDDA1P3_BB – 0.05 V. When enabled, the ADC is free running. SPI reads provide the last value latched at the ADC output. A multiplexer in front of the ADC allows the user to select between the AUXADC input pin and a built-in temperature sensor.

AUXDAC1 and AUXDAC2

The AD9364 contains two identical auxiliary DACs that can provide power amplifier (PA) bias or other system functionality. The auxiliary DACs are 10 bits wide, have an output voltage range of 0.5 V to VDD_GPO – 0.3 V, a current drive of 10 mA, and can be directly controlled by the internal enable state machine.

POWERING THE AD9364

The AD9364 must be powered by the following three supplies: the analog supply (VDDD1P3_DIG/VDDAx = 1.3 V), the interface supply (VDD_INTERFACE = 1.8 V), and the GPO supply (VDD_GPO = 3.3 V).

For applications requiring optimal noise performance, it is recommended that the 1.3 V analog supply be split and sourced from low noise, low dropout (LDO) regulators. Figure 74 shows the recommended method.



Figure 74. Low Noise Power Solution for the AD9364

For applications where board space is at a premium, and optimal noise performance is not an absolute requirement, the 1.3 V analog rail can be provided directly from a switcher, and a more integrated power management unit (PMU) approach can be adopted. Figure 75 shows this approach.

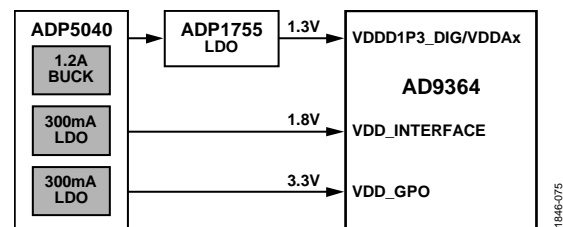
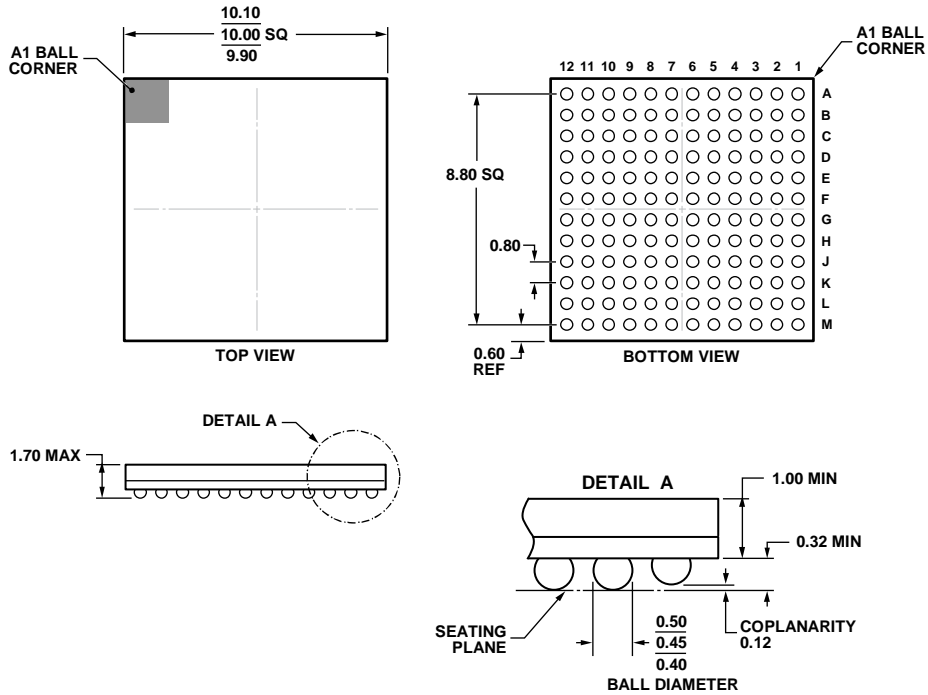

Figure 75. Space-Optimized Power Solution for the AD9364

PACKAGING AND ORDERING INFORMATION

OUTLINE DIMENSIONS



COMPLIANT TO JEDEC STANDARDS MO-275-EEAB-1.

Figure 76. 144-Ball Chip Scale Package Ball Grid Array [CSP_BGA] (BC-144-7)
Dimensions shown in millimeters

11-18-2011-A

ORDERING GUIDE

| Model ¹ | Temperature Range | Package Description | Package Option |
|--------------------|-------------------|---------------------|----------------|
| AD9364BBCZ | -40°C to +85°C | 144-Ball CSP_BGA | BC-144-7 |
| AD9364BBCZREEL | -40°C to +85°C | 144-Ball CSP_BGA | BC-144-7 |

¹ Z = RoHS Compliant Part.

NOTES

X-ON Electronics

Largest Supplier of Electrical and Electronic Components

Click to view similar products for [System-On-Modules - SOM category](#):

Click to view products by [Analog Devices manufacturer](#):

Other Similar products are found below :

[COMX-CORE-310](#) [COMX-P4040-4G-ENP2](#) [PICOIMX6U10R1GBNI4G](#) [PICOIMX6U10R1GBNI4GBW](#) [MC27561-TIGER](#) [CC-WMX6UL-SMPL](#) [CB-52-PUS-110-SX](#) [BD63725BEFV-EVK-002](#) [5728-PJ-4AA-RI](#) [A00150](#) [COMX_P4080](#) [A20-SOM-EVB](#) [RK3188-SOM](#) [RK3188-SOM-4GB](#) [100-1225-1](#) [PICOIMX6Q10R1GBNI4G](#) [Nit6Q](#) [A20-SOM-N8GB](#) [PER-TAICX-A10-001](#) [PER-TAIX2-A10-2280](#) [EDL-mPCIe-MA2485](#) [SOM-5897C7-U0A1E](#) [SOM-6896C7-U2A1E](#) [SCM180-Dual-2G_Industrial](#) [3354-HX-X38-RC](#) [3359-GX-226-RC](#) [5728-PJ-4AA-RC](#) [6455-JE-3X5-RC](#) [Morph-IC-II](#) [ET876-X7LV](#) [IFC6301-10-P2](#) [IFC6502-00-P1](#) [IFC67A1-00-P1](#) [IFC6701-00-P1](#) [iW-G33M-SCMQ-4L002G-E008G-BII](#) [PWSE1000200B](#) [CS-DEPTHAI-04](#) [MYC-C8MMQ6-8E2D-180-C](#) [MYD-C4378-4E512D-100-I](#) [MOD5213-100IR](#) [A20-SOM](#) [A20-SOM204-1G](#) [A20-SOM204-1GS16ME16G-MC](#) [AM3352-SOM-EVB](#) [BS1-IC](#) [BS2-IC](#) [102110278](#) [SLS16Y2_792C_256R_256N_0SF_I](#) [SLS12RT52_528C_0R_4QSPI_0SF_I](#) [SLS12RT52_528C_32R_16QSPI_0SF_I](#)