

FEATURES

- MEMS pitch and roll rate gyroscope**
- Ultralow noise: $0.004^\circ/s/\sqrt{\text{Hz}}$**
- High vibration rejection over a wide frequency range**
- Power saving standby mode**
 - 80 μA current consumption in standby mode**
 - Fast startup time from standby mode: <100 ms**
- Low delay of <0.5 ms for a 30 Hz input at the widest bandwidth setting**
- Serial peripheral interface (SPI) digital output**
- Programmable high-pass and low-pass filters**
- 2000 g powered acceleration survivability**
- 2.7 V to 5.0 V operation**
- 25°C to +85°C operation**
- 4.5 mm \times 5.8 mm \times 1.2 mm cavity laminate package**

APPLICATIONS

- Optical image stabilization**
- Platform stabilization**
- Wearable products**

GENERAL DESCRIPTION

The [ADXRS290](#) is a high performance MEMS pitch and roll (dual-axis in-plane) angular rate sensor (gyroscope) designed for use in stabilization applications.

The [ADXRS290](#) provides an output full-scale range of $\pm 100^\circ/s$ with a sensitivity of 200 LSB/ $^\circ/s$. Its resonating disk sensor structure enables angular rate measurement about the axes normal to the sides of the package around an in-plane axis. Angular rate data is formatted as 16-bit twos complement and is accessible through a SPI digital interface. The [ADXRS290](#) exhibits a low noise floor of $0.004^\circ/s/\sqrt{\text{Hz}}$ and features programmable high-pass and low-pass filters.

The [ADXRS290](#) is available in a 4.5 mm \times 5.8 mm \times 1.2 mm, 18-terminal cavity laminate package.

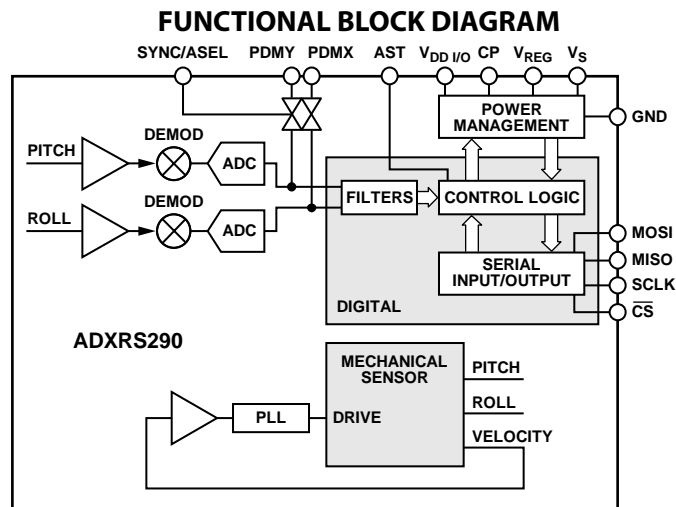

Figure 1.

Rev. A

Document Feedback

Information furnished by Analog Devices is believed to be accurate and reliable. However, no responsibility is assumed by Analog Devices for its use, nor for any infringements of patents or other rights of third parties that may result from its use. Specifications subject to change without notice. No license is granted by implication or otherwise under any patent or patent rights of Analog Devices. Trademarks and registered trademarks are the property of their respective owners.

TABLE OF CONTENTS

Features	1	Mechanical Considerations for Mounting.....	13
Applications.....	1	Serial Communications	14
General Description	1	Register Map	16
Functional Block Diagram	1	Register Descriptions	17
Revision History	2	Analog Devices Identifier.....	17
Specifications.....	3	MEMS Identifier.....	17
Absolute Maximum Ratings.....	4	Device Identifier	17
Rate Sensitive Axes.....	4	Silicon Revision Number	17
Package Information	4	Serial Number (SNx)	17
ESD Caution.....	4	Rate Output Data	17
Pin Configuration and Function Descriptions.....	5	Temperature Data.....	17
Typical Performance Characteristics	6	Power Control.....	17
Theory of Operation	10	Band-Pass Filter	17
Applications Information	11	Data Ready	17
Application Circuit.....	11	Recommended Soldering Profile	18
Power Supply Decoupling	11	PCB Footprint Pattern	18
Power Sequencing	11	Outline Dimensions	19
Setting Bandwidth	11	Ordering Guide	19
Analog Evaluation Mode.....	12		

REVISION HISTORY

12/14—Rev.0 to Rev. A

Changes to Title	1
Changes to Features Section and General Description Section.....	1

10/14—Revision 0: Initial Version

SPECIFICATIONS

Specified conditions at $T_A = 25^\circ\text{C}$. $V_S = V_{DD I/O} = 3\text{ V}$, angular rate = $0^\circ/\text{sec}$, bandwidth = dc to 480 Hz, $C_S = C_{\text{REG}} = C_{I/O} = C_{CP} = 1\ \mu\text{F}$, digital mode, temperature sensor = off, unless otherwise noted. All minimum and maximum specifications are guaranteed. Typical specifications are not tested or guaranteed.

Table 1.

Parameter	Test Conditions/Comments	Min	Typ	Max	Unit
MEASUREMENT RANGE	Each axis				
Output Full-Scale Range			±100		°/s
Resolution			16		Bits
Gyroscope Data Update Rate			4250		Hz
LINEARITY					
Nonlinearity			±0.5		% FS
Cross Axis Sensitivity			±2.0		%
SENSITIVITY					
Sensitivity			200		LSB/°/s
Initial Sensitivity Tolerance ¹	$T_A = 25^\circ\text{C}$	-12	±3	+12	%
Change Due to Temperature	$T_A = -20^\circ\text{C}$ to $+60^\circ\text{C}$		±1		%
OFFSET					
Offset Error	$T_A = -20^\circ\text{C}$ to $+60^\circ\text{C}$		±9		°/s
NOISE PERFORMANCE					
Rate Noise Density	$T_A = 25^\circ\text{C}$ at 10 Hz		0.004		°/s/√Hz
FREQUENCY RESPONSE	Programmable (see the Setting Bandwidth section)				
-3 dB Frequency ²					
Low-Pass Filter		20		480	Hz
High-Pass Filter	DC output setting available	0.011		11.3	Hz
Delay	30 Hz input, low-pass filter (LPF) = 480 Hz		<0.5		ms
POWER SUPPLY					
Operating Voltage Range ($V_S, V_{DD I/O}$)		2.7		5.0	V
Supply Current	Measurement mode		7.8		mA
	Standby mode		80		μA
Start-Up Time (Standby)	Power off to standby mode		<5		ms
Start-Up Time (Measurement Mode)	Standby to measurement mode (to within ±1°/s of final value)		<100		ms
TEMPERATURE SENSOR					
Resolution			12		Bits
Sensitivity			0.1		°C/LSB
OPERATING TEMPERATURE RANGE					
Operating Temperature Range		-25		+85	°C

¹ Initial sensitivity tolerance minimum and maximum specifications are guaranteed by characterization and are not tested in production.

² Guaranteed by design and are not tested in production.

ABSOLUTE MAXIMUM RATINGS

Table 2.

Parameter	Rating
Acceleration (Any Axis, Unpowered, 0.5 ms)	2000 <i>g</i>
Acceleration (Any Axis, Powered, 0.5 ms)	2000 <i>g</i>
$V_S, V_{DD I/O}$	2.7 V to 5.25 V
All Other Pins	2.7 V to 5.25 V
Output Short-Circuit Duration (Any Pin to Common)	Indefinite
Operating Temperature Range	-40°C to +105°C
Storage Temperature Range	-40°C to +105°C

Stresses at or above those listed under Absolute Maximum Ratings may cause permanent damage to the product. This is a stress rating only; functional operation of the product at these or any other conditions above those indicated in the operational section of this specification is not implied. Operation beyond the maximum operating conditions for extended periods may affect product reliability.

RATE SENSITIVE AXES

The ADXRS290 is an x-axis and y-axis rate sensing device that is also called a roll and pitch rate sensing device. It produces a positive output voltage for clockwise rotation about the x-axis and y-axis, as shown in Figure 2.

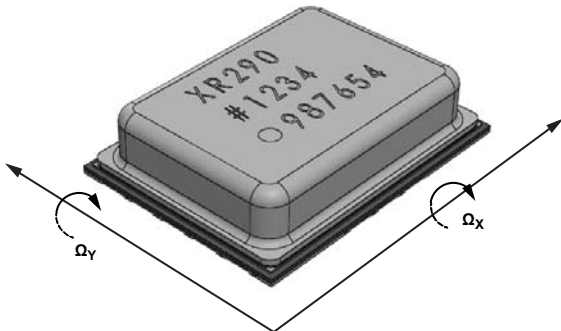

Figure 2. Axes of Sensitivity

12836-002

PACKAGE INFORMATION

The information in Figure 2 and Table 3 provide details about the package branding for the ADXRS290. For a complete listing of product availability, see the Ordering Guide section.

Table 3. Package Branding Information

Branding Key	Field Description
XR290	Part identifier for ADXRS290
#yyyy	Date code
●XXXXXX	Pin 1 and factory lot code identifiers

ESD CAUTION



ESD (electrostatic discharge) sensitive device. Charged devices and circuit boards can discharge without detection. Although this product features patented or proprietary protection circuitry, damage may occur on devices subjected to high energy ESD. Therefore, proper ESD precautions should be taken to avoid performance degradation or loss of functionality.

PIN CONFIGURATION AND FUNCTION DESCRIPTIONS

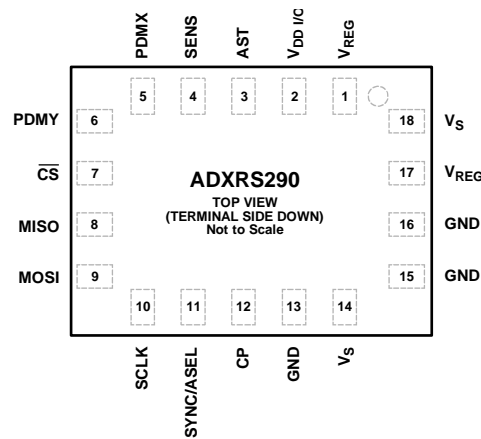

Figure 3. Pin Configuration (Top View)

Table 4. Pin Function Descriptions

Pin No.	Mnemonic	Description	
		Digital Mode	Analog Evaluation Mode
1	V _{REG}	Regulator Output. Connect a 1 μ F capacitor to this pin.	Regulator Output. Connect a 1 μ F capacitor to this pin.
2	V _{DD I/O}	Digital Interface Supply Voltage.	Digital Interface Supply Voltage.
3	AST	This pin is internally pulled to ground.	Self Test.
4	SENS	This pin is internally pulled to ground.	Sensitivity Select.
5	PDMX	This pin is internally pulled to ground.	Pulse-Density Modulation (PDM) X _{OUT} .
6	PDMY	This pin is internally pulled to ground.	PDM Y _{OUT} .
7	$\overline{\text{CS}}$	Chip Select. Active low.	Chip Select. Active low.
8	MISO (SDO)	Serial Data Out.	Serial Data Out.
9	MOSI (SDI)	Serial Data In.	Serial Data In.
10	SCLK	Serial Communications Clock.	Serial Communications Clock.
11	SYNC/ASEL	Data Ready Out (SYNC). Connect this pin to ground if it is not used.	Analog Enable (ASEL).
12	CP	Charge Pump Output. Connect a 1 μ F capacitor (rated for 50 V) to this pin.	Charge Pump Output. Connect a 1 μ F capacitor (rated for 50 V) to this pin.
13, 15, 16	GND	Ground. Connect to ground.	Ground. Connect to ground.
14	V _S	Analog Supply Voltage.	Analog Supply Voltage.
17	V _{REG}	Regulator Output. Connect a 1 μ F capacitor to this pin.	Regulator Output. Connect a 1 μ F capacitor to this pin.
18	V _S	Analog Supply Voltage.	Analog Supply Voltage.

TYPICAL PERFORMANCE CHARACTERISTICS

N > 240 for all typical performance characteristics plots, unless otherwise noted.

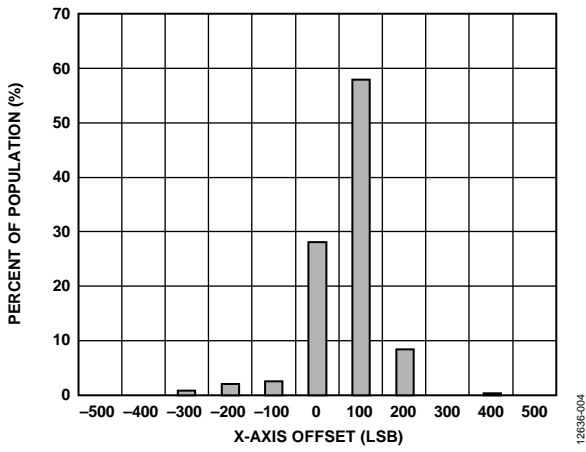

Figure 4. X-Axis Offset at 25°C

12639-004

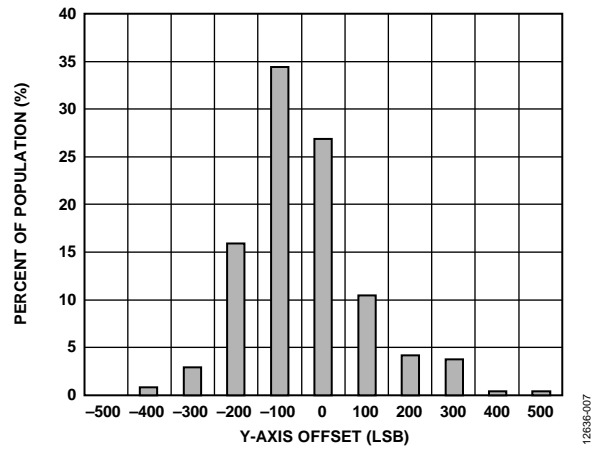

Figure 7. Y-Axis Offset at 25°C

12639-007

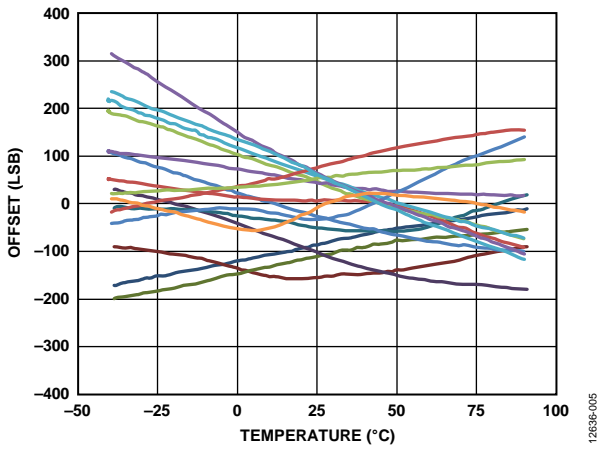

Figure 5. X-Axis Offset vs. Temperature (N = 16)

12639-005

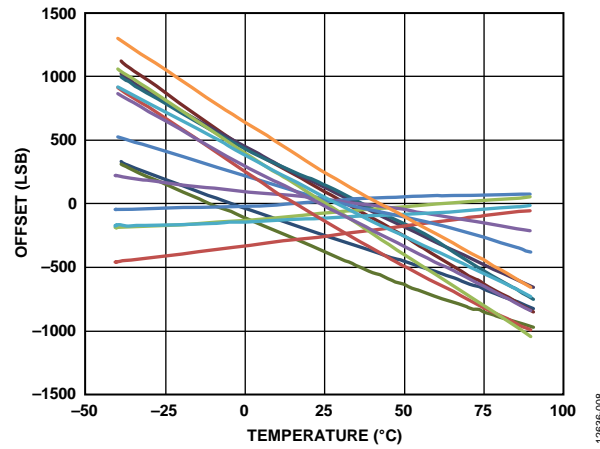

Figure 8. Y-Axis Offset vs. Temperature (N = 16)

12639-008

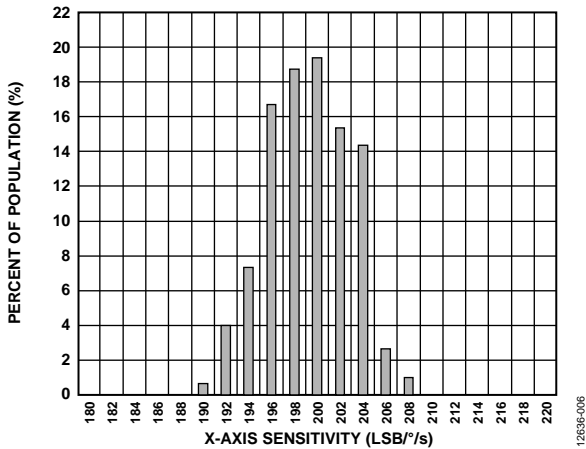

Figure 6. X-Axis Sensitivity at 25°C

12639-006

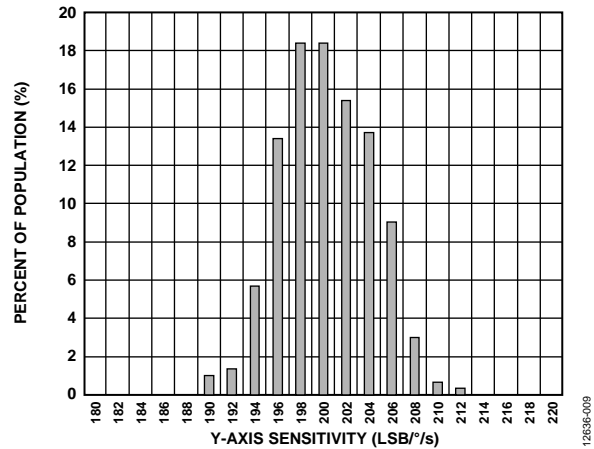

Figure 9. Y-Axis Sensitivity at 25°C

12639-009

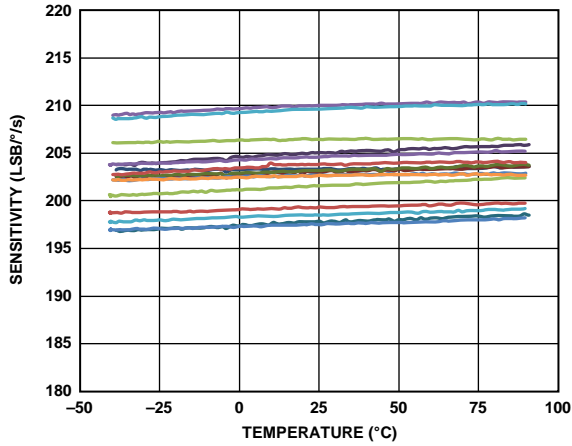

Figure 10. X-Axis Sensitivity vs. Temperature (N = 16)

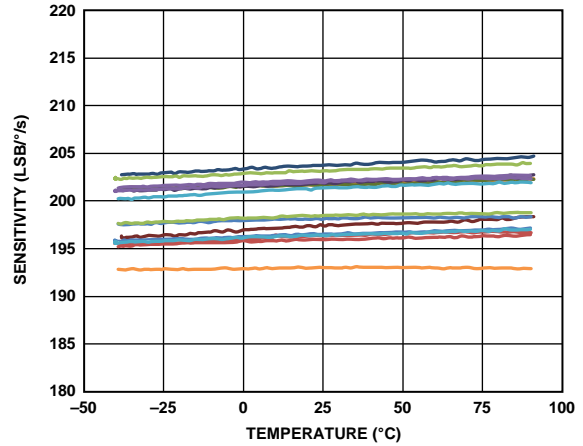

Figure 13. Y-Axis Sensitivity vs. Temperature (N = 16)

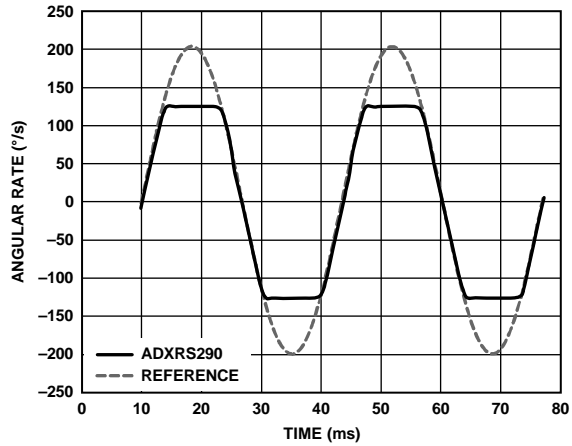

Figure 11. Rate Output Saturation Behavior

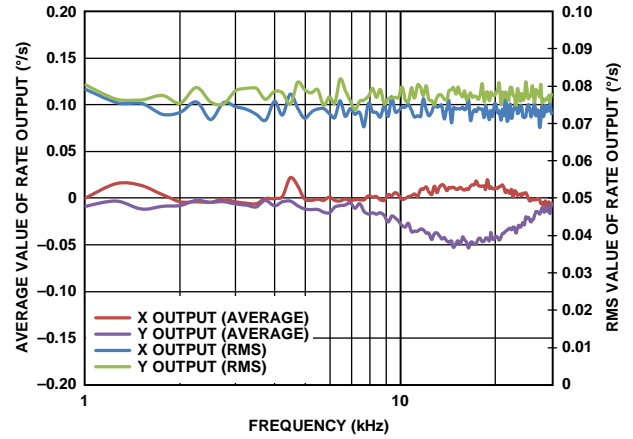

Figure 14. Response to 10 g Sine Vibration Along the Z-Axis (Out-of-Plane), HPF = Off and LPF = 480 Hz

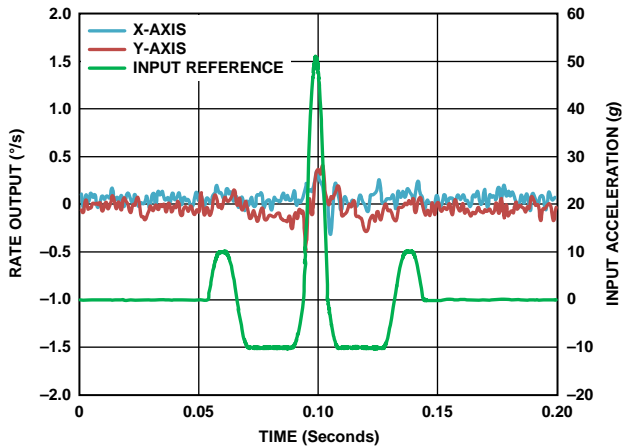

Figure 12. Response to 50 g, 10 ms Half-Sine Shock Along the Z-Axis (Out-of-Plane), HPF = Off and LPF = 480 Hz

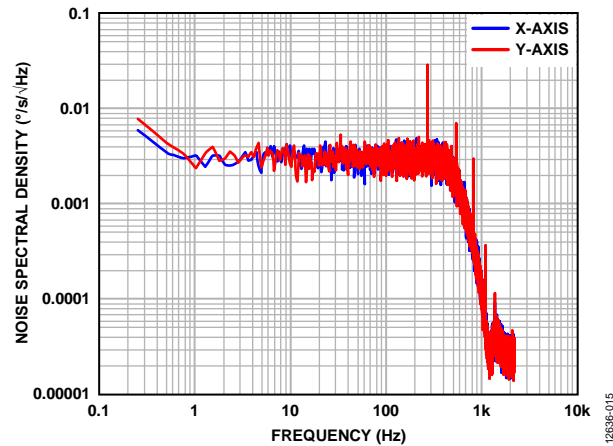

Figure 15. Typical Noise Spectral Density

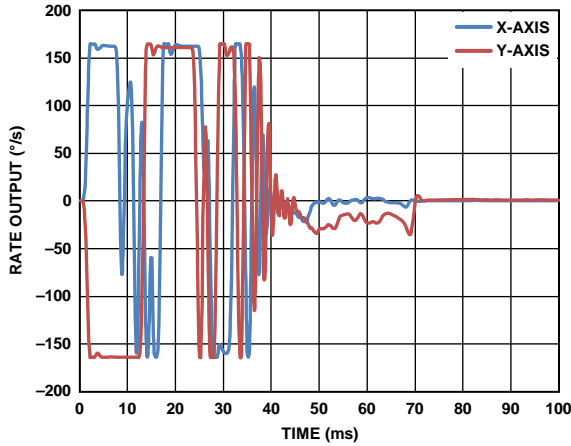

Figure 16. Start-Up Time (Standby to Measurement Mode)

12636-017

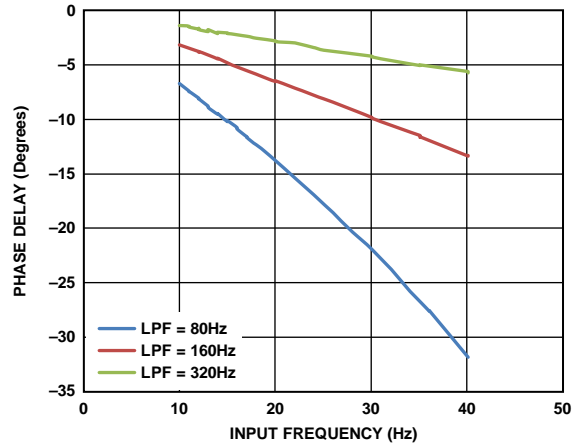

Figure 19. Low-Pass Filter Phase Delay

12636-020

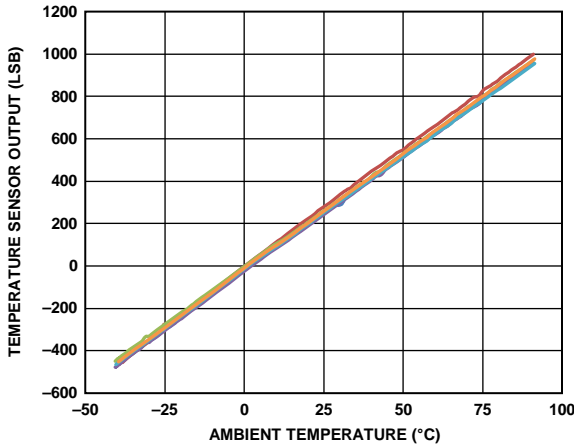

Figure 17. Temperature Sensor Output vs. Ambient Temperature (N = 16)

12636-023

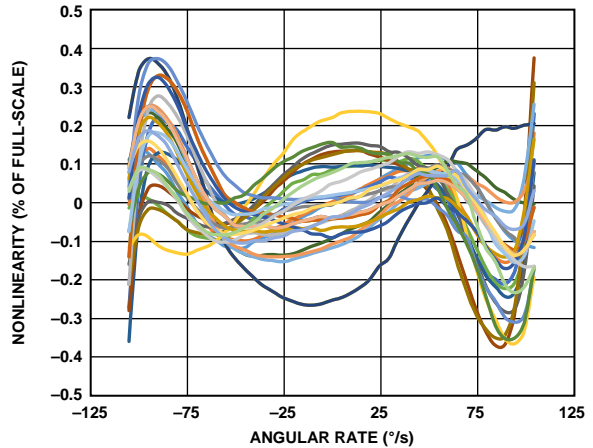

Figure 20. Rate Output Nonlinearity (N = 15)

12636-022

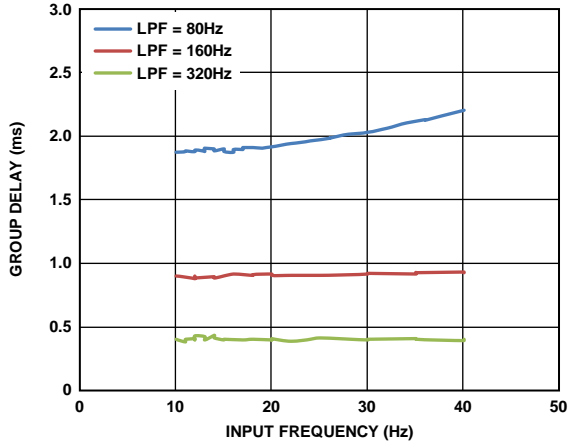

Figure 18. Low-Pass Filter Group Delay

12636-021

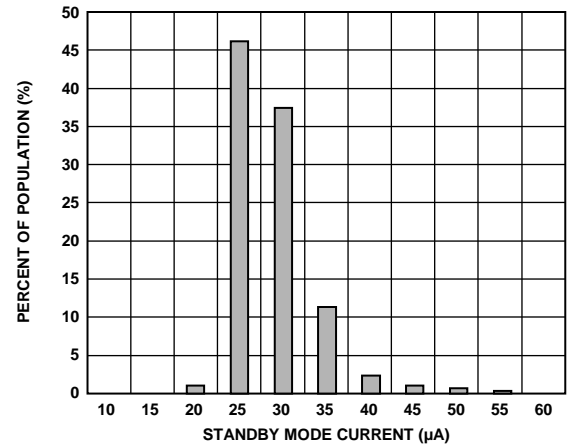

Figure 21. Standby Mode Current Consumption

12636-019

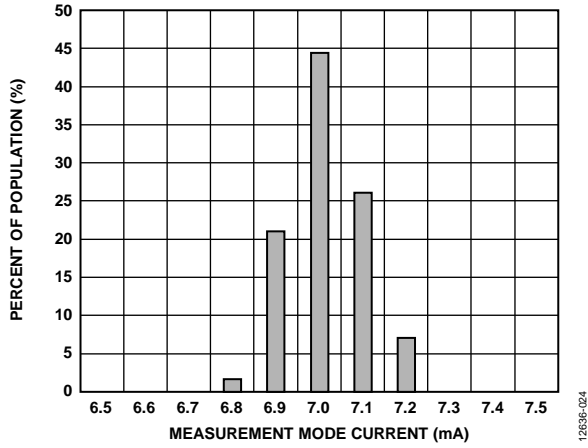

Figure 22. Measurement Mode Current Consumption

12036-1024

THEORY OF OPERATION

The ADXR290 is designed to sense x-axis and y-axis (roll and pitch) angular rate. The ADXR290 operates on the principle of a vibratory rate gyroscope. Figure 23 presents a simplified illustration of one of four, coupled polysilicon sensing structures. Each sensing structure contains a resonating disk that is electrostatically driven to resonance, which produces the necessary rotating velocity element needed to generate a Coriolis torque when experiencing angular rate.

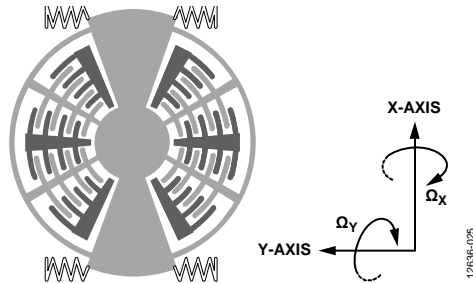

Figure 23. Simplified Gyroscope Sensing Structure

When the sensing structure is exposed to an angular rate, the resulting Coriolis torque drives each of the disks into a tilting motion, which is sensed by plates under the disk. The disk and plate form a capacitive pickoff structure that senses angular rate. The resulting signal is fed to a series of gain and demodulation stages that produce the electrical rate signal output. The sensor design rejects linear and angular acceleration because external g -forces appear as common-mode signals that are removed by the fully differential architecture of the ADXR290.

The resonator requires 31 V (typical) for operation. Because only 5 V is typically available in most applications, a switching regulator is included on-chip. An external 1 μ F capacitor rated for 50 V is required for proper operation of the charge pump circuit.

After demodulation and analog-to-digital conversion, the rate signal is filtered using a single-pole band-pass filter. The high-pass and low-pass poles of this filter are programmable via the digital interface.

APPLICATIONS INFORMATION

APPLICATION CIRCUIT

The ADXRS290 application circuit is shown in Figure 24. The primary communications port is the 4-wire SPI interface. For this device, external pull-up/pull-down resistors are not required for the SPI interface, and these pins can be connected directly to the system microcontroller. Four capacitors are required for proper operation of the device. For optimum device performance, separate the capacitors placed on the V_S , $V_{DD\ I/O}$, V_{REG} , and CP pins.

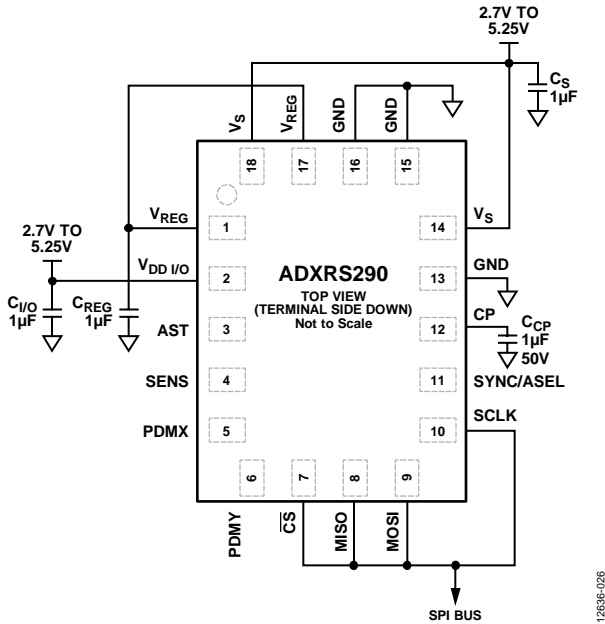

Figure 24. Recommended Application Circuit

POWER SUPPLY DECOUPLING

In many applications, bypass capacitors at V_S , V_{REG} , and $V_{DD\ I/O}$ (as shown in Figure 24) placed close to the ADXRS290 supply pins adequately decouple the gyroscope from noise on the power supply. However, in applications where noise is present at the internal clock frequency, or any harmonic thereof, additional care in power supply bypassing is required because this noise may cause errors in angular rate measurement. If additional decoupling is necessary, a 10 Ω resistor or ferrite bead in series with V_S and an additional larger bypass capacitor (2.2 μF or greater) at V_S may be helpful.

Ensure that the connection from the ADXRS290 ground to the power supply ground be low impedance because noise transmitted through ground has an effect similar to noise transmitted through V_S .

POWER SEQUENCING

The interface voltage level is set with the interface supply voltage $V_{DD\ I/O}$, which must be present to ensure that the ADXRS290 does not create a conflict on the communications bus. For single-supply operation, $V_{DD\ I/O}$ can be the same as the main supply (V_S). Conversely, in a dual-supply application, $V_{DD\ I/O}$ can differ from V_S to accommodate the desired interface voltage. When V_S is applied, the device enters standby state, where power consumption is minimized, and the device waits for $V_{DD\ I/O}$ to be applied and for a command to enter measurement mode. Measurement mode is activated by setting Bit B1 in Register 0x10 (POWER_CTL). Clear this bit to return the device to a standby state.

In standby mode, the current consumption is reduced to 80 μA (typical). In standby mode, only single-address SPI transactions are performed, which includes reading from or writing to a single register, but does not include writing to or reading from several registers in one command. In standby mode, the gyroscope does not respond to rate outputs. Transition time to measurement mode where offsets settle to within $\pm 1^\circ/\text{s}$ of the final value is < 100 ms.

SETTING BANDWIDTH

The ADXRS290 includes an internal configurable band-pass filter. Both the high-pass and low-pass poles of the filter are adjustable, as shown in Table 5 and Table 6. The filter frequency response is shown in Figure 25 and Figure 26. The group delay of the wideband filter option is less than 0.5 ms (see Figure 18 for filter delay). At power-up, the default condition for the filters is dc for the high-pass filter and 480 Hz for the low-pass filter.

Table 5. Low-Pass Filter Pole Locations

Bit 2 Filter	Bit 1 Filter	Bit 0 Filter	Frequency (Hz)
0	0	0	480 (Default)
0	0	1	320
0	1	0	160
0	1	1	80
1	0	0	56.6
1	0	1	40
1	1	0	28.3
1	1	1	20

Table 6. High-Pass Filter Pole Locations

Bit 7 Filter	Bit 6 Filter	Bit 5 Filter	Bit 4 Filter	Frequency (Hz)
0	0	0	0	All pass (default)
0	0	0	1	0.011
0	0	1	0	0.022
0	0	1	1	0.044
0	1	0	0	0.087
0	1	0	1	0.175
0	1	1	0	0.350
0	1	1	1	0.700
1	0	0	0	1.400
1	0	0	1	2.800
1	0	1	0	11.30

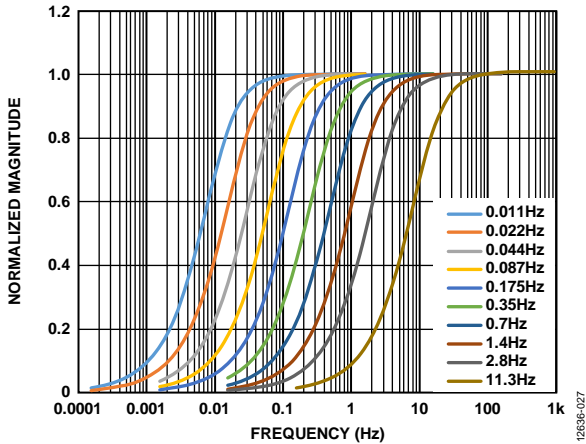

Figure 25. High-Pass Filter Frequency Response

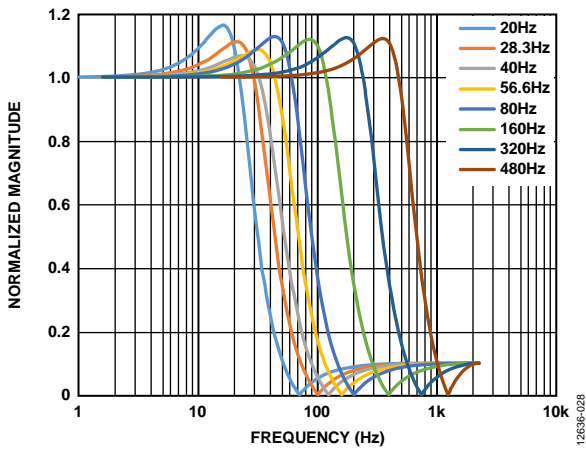

Figure 26. Low-Pass Filter Frequency Response

Offset Preservation in the High-Pass Filter

One of the functions of the high-pass filter is to remove offset. The high-pass filter effectively estimates the offset and subtracts it from the output. When the high-pass filter settings are changed, the output remains unchanged; the filter preserves its estimate of offset. The high-pass filter can be set to the fast settling option, allowed to converge to zero offset, and then set to any other high-pass filter option while maintaining near zero offset. Exiting measurement mode clears the preserved offset.

ANALOG EVALUATION MODE

An analog output evaluation mode has been incorporated in the ADXRS290. In this mode, the output of the ADXRS290 is formatted as a pulse density modulated data stream at a frequency of 144 kHz via the PDMX and PDMY pins. The PDMX and PDMY pins high and low voltage levels are ratiometric to $V_{DD I/O}$. This signal can be decoded into an analog baseband using a low-pass filter. Higher order filters allow for greater attenuation of the 144 kHz switching noise while maintaining the integrity of the baseband signal. A recommended application circuit with a third-order Sallen-Key filter is shown in Figure 27. Figure 28 shows the recommended low-pass filter for demodulating the PDM output in analog mode operation.

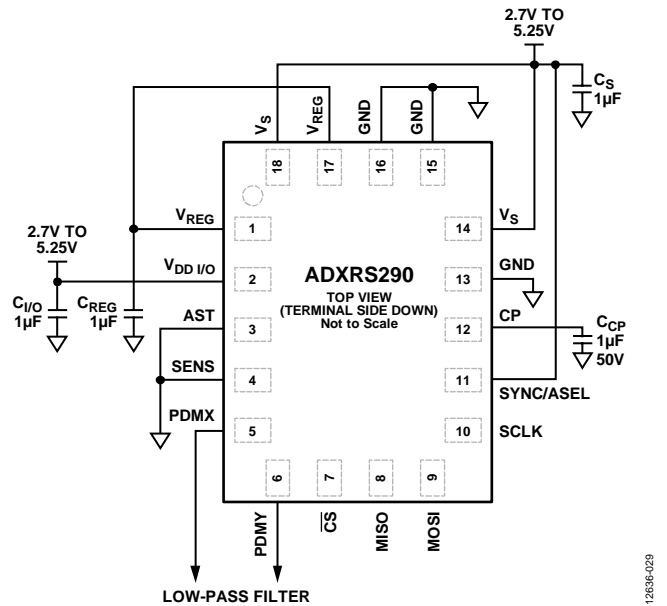

Figure 27. Recommended Application Circuit for Analog Mode Operation

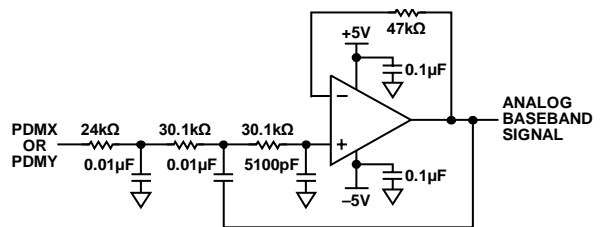

Figure 28. Recommended Low-Pass Filter for Demodulating the PDM Output in Analog Mode Operation

In analog mode, the band-pass filter is disabled and the device cannot be placed in standby mode. SPI communication to the ADXRS290 is available but not required. Sensitivity in this mode is 5 mV/°/s.

MECHANICAL CONSIDERATIONS FOR MOUNTING

Mount the [ADXRS290](#) on the printed circuit board (PCB) in a location close to a hard mounting point of the PCB to the case. Mounting the [ADXRS290](#) at an unsupported PCB location, as shown in Figure 29, may result in large, apparent measurement errors due to undamped PCB vibration. Locating the [ADXRS290](#) near a hard mounting point ensures that any PCB vibration at the device is above the resonant frequencies of the MEMS elements and, therefore, effectively invisible to the device. In applications where the gyroscope may be subjected to large shock events or excessive vibration, consider the use of damping materials (such as Polyurethane) at the mounting locations to dampen the vibration. A thicker PCB can also help to reduce the effect of system resonance on the performance of the [ADXRS290](#).

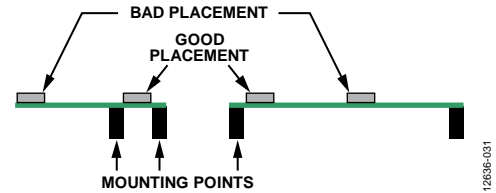

Figure 29. Two Examples of Incorrectly Mounted Gyroscopes

SERIAL COMMUNICATIONS

In digital mode, the ADXRS290 communicates via 4-wire SPI and operates as a slave. Ignore data transmitted from the ADXRS290 to the master device during writes to the ADXRS290.

Wire the ADXRS290 for SPI communication as shown in the connection diagram in Figure 30. The maximum SPI clock speed is 5 MHz, with 12 pF maximum loading. The timing scheme follows clock phase (CPHA) = clock polarity (CPOL) = 1.

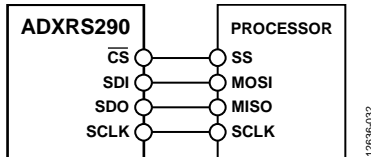

Figure 30. 4-Wire SPI Connection

\overline{CS} is the serial port enable line and is controlled by the SPI master. It must go low at the start of transmissions and high at the end as shown in Figure 31. SCLK is the serial port clock and is supplied by the SPI master. It is stopped high when \overline{CS} is high, during periods of no transmission. At the rising edge of SCLK,

data can be sampled. Unless the ADXRS290 is in standby mode, multiple bytes can be written to or read from in a single transmission. In standby mode, only single register transactions are supported. Deasserting the \overline{CS} pin is necessary between commands for transmissions with multiple commands. For SPI operation greater than 1 MHz, it is necessary to deassert the \overline{CS} pin to ensure a total delay of 10 μ s between the register addressing portion of the transmission. The delay is required to allow settling of the internal voltage controlled oscillator. For SPI operation of 1 MHz or lower, the communication rate is low enough to ensure a sufficient delay between register writes.

SPI read and write operations are completed in 16 or more clock cycles, as shown in Figure 31. Setting the R/W bit to 1 indicates a read operation and setting it to 0 indicates a write operation. For R/W = 0 (write), [D7:D0] data is written to the device in the register map based on the [A6:A0] addresses. For R/W = 1 (read), [D7:D0] is the data read by the external master device based on the [A6:A0] addresses. Examples of SPI write and read are shown in Figure 32 and Figure 33.

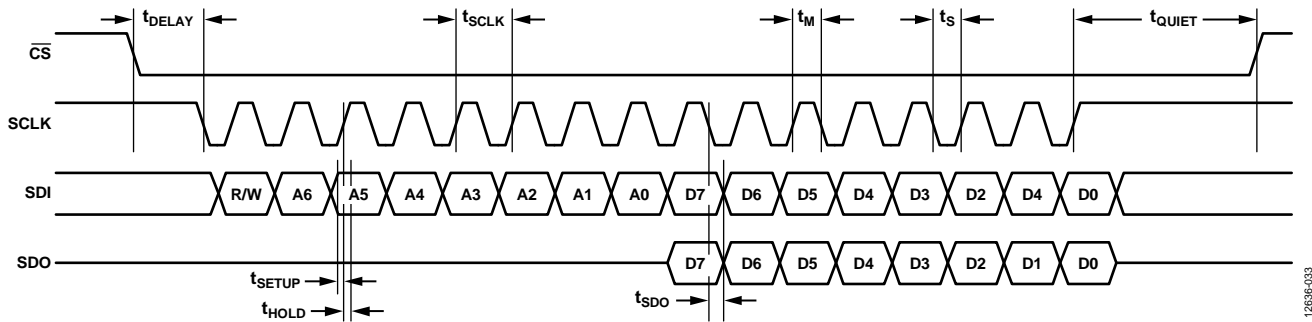

Figure 31. SPI Timing Diagram

Table 7. SPI Timing Specifications ($T_A = 25^\circ\text{C}$, $V_S = V_{DD1/O} = 2.7\text{ V}$)

Parameter	Limit	Unit	Description
f_{SCLK}	5	MHz max	SPI clock frequency
t_{SCLK}	200	ns min	$1/(\text{SPI clock frequency})$, mark/space ratio for the SCLK input is 40/60 to 60/40
t_{DELAY}	200	ns min	\overline{CS} falling edge to SCLK falling edge
t_{QUIET}	200	ns min	SCLK rising edge to \overline{CS} rising edge
t_S	$0.4 \times t_{SCLK}$	ns min	SCLK low pulse width (space)
t_M	$0.4 \times t_{SCLK}$	ns min	SCLK high pulse width (mark)
t_{SDO}	20	ns max	SCLK falling edge to SDO transition
t_{SETUP}	10	ns min	SDI valid before SCLK rising edge
t_{HOLD}	10	ns min	SDI valid after SCLK rising edge

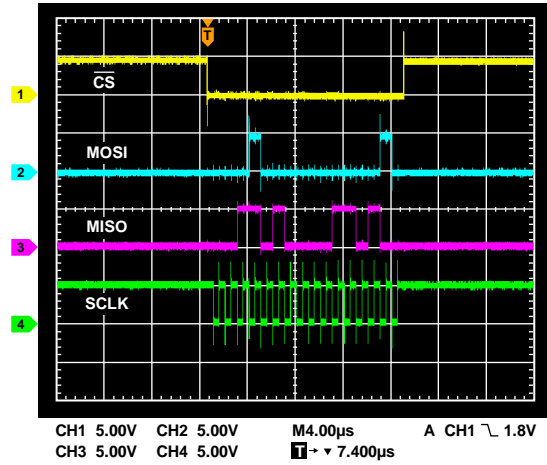

Figure 32. SPI Write Example: Writing to Register 0x10 (Write 0x02 to Enter Measurement Mode)

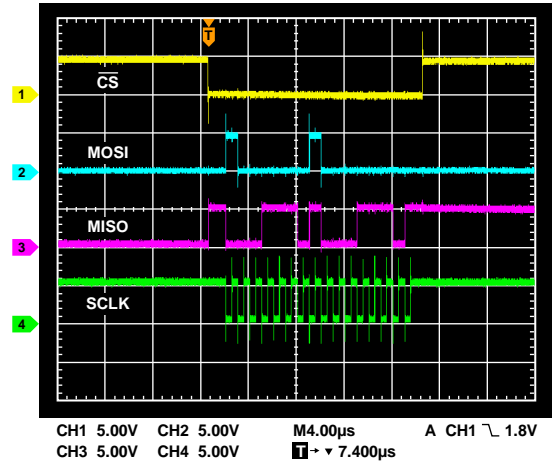

Figure 33. SPI Read Example: Reading Register 0x01 (Output = 0x1D)

REGISTER MAP

Table 8.

Register No. (Hex)	Name	Bit 7	Bit 6	Bit 5	Bit 4	Bit 3	Bit 2	Bit 1	Bit 0	Reset	R/W
0x00	ADI_ID	ADI_ID[7:0]							10101101		R
0x01	MEMS_ID	MEMS_ID[7:0]							00011101		R
0x02	DEV_ID	DEV_ID[7:0]							10010010		R
0x03	REV_ID	REV_ID[7:0]							00001001		R
0x04	SN0	SN[7:0]							SN[7:0]		R
0x05	SN1	SN[15:8]							SN[15:8]		R
0x06	SN2	SN[23:16]							SN[23:16]		R
0x07	SN3	SN[31:24]							SN[31:24]		R
0x08	DATA_X0	X0[7:0]							00000000		R
0x09	DATA_X1	X1[15:8]							00000000		R
0x0A	DATA_Y0	Y0[7:0]							00000000		R
0x0B	DATA_Y1	Y1[15:8]							00000000		R
0x0C	TEMP0	TEMP[7:0]							00000000		R
0x0D	TEMP1	0	0	0	0	TEMP[11:8]			00000000	R	
0x0E	Reserved	Reserved[7:0]							00000000		R
0x0F	Reserved	Reserved[7:0]							00000011		R
0x10	POWER_CTL	0	0	0	0	0	0	Measurement	TSM	00000000	R/W
0x11	Filter	HPF[3:0]				0	LPF[2:0]			00000000	R/W
0x012	DATA_READY	0	0	0	0	0	0	Sync[1:0]		00000000	R/W

REGISTER DESCRIPTIONS

This section describes the functions of the [ADXRS290](#) registers. The [ADXRS290](#) powers up with default register values as shown in the reset column of Table 8.

ANALOG DEVICES IDENTIFIER

Table 9. Register 0x00, ADI_ID (Read Only)

Bit 7	Bit 6	Bit 5	Bit 4	Bit 3	Bit 2	Bit 1	Bit 0
1	0	1	0	1	1	0	1

The ADI_ID register holds a fixed code 0xAD.

MEMS IDENTIFIER

Table 10. Register 0x01, MEMS_ID (Read Only)

Bit 7	Bit 6	Bit 5	Bit 4	Bit 3	Bit 2	Bit 1	Bit 0
0	0	0	1	1	1	0	1

The MEMS_ID register holds a fixed code of 0x1D.

DEVICE IDENTIFIER

Table 11. Register 0x02, DEV_ID (Read Only)

Bit 7	Bit 6	Bit 5	Bit 4	Bit 3	Bit 2	Bit 1	Bit 0
1	0	0	1	0	0	1	0

The DEV_ID register holds a fixed code of 0x92.

SILICON REVISION NUMBER

Table 12. Register 0x03, REV_ID (Read Only)

Bit 7	Bit 6	Bit 5	Bit 4	Bit 3	Bit 2	Bit 1	Bit 0
0	0	0	0	1	0	0	1

The REV_ID register holds a revision ID code that increments with each subsequent silicon revision.

SERIAL NUMBER (SNx)

These four bytes (Register 0x04 to Register 0x07) store the unique electronic serial number for the part.

RATE OUTPUT DATA

Register 0x08 to Register 0x0B: DATA0, DATA1, DATAY0, and DATAY1 (Read Only)

These four bytes (Register 0x08 to Register 0x0B) hold the rate output data for each axis. Register 0x08 and Register 0x09 hold the output data for the x-axis, and Register 0x0A and Register 0x0B hold the output data for the y-axis. The output data is written in twos complement. In each two byte set, DATAx0 is the least significant byte, and DATAx1 is the most significant byte, where x represents the x-axis or the y-axis. To prevent a change in data between reads of the sequential registers, perform a multiple byte read of all rate output data registers.

TEMPERATURE DATA

Register 0x0C to Register 0x0D: TEMP0 and TEMP1 (Read Only)

These two bytes hold temperature output data written in twos complement. Register 0x0C contains Bits[7:0] and Register 0x0D contains Bits[11:8] of the 12-bit temperature reading. When concurrent temperature and output data points are desired, perform a multiple byte read of the TEMP1:TEMP0, DATA1:DATA0, and DATAY1:DATAY0 registers. The scale factor of the temperature reading is 10 LSB/°C, and 0 codes is equivalent to 0°C.

POWER CONTROL

Table 13. Register 0x10, POWER_CTL (Read/Write)

Bit 7	Bit 6	Bit 5	Bit 4	Bit 3	Bit 2	Bit 1	Bit 0
0	0	0	0	0	0	Measurement	TSM

TSM Bit

The TSM bit controls the temperature sensor. The default value of this bit is 0 (temperature sensor off) and setting this bit to 1 enables the temperature sensor.

Measurement Bit

To set the [ADXRS290](#) to standby mode, set the measurement bit to 0. To set the [ADXRS290](#) to measurement mode, set this bit to 1.

The [ADXRS290](#) powers up in standby mode with a current consumption of 80 μ A (typical).

BAND-PASS FILTER

Table 14. Register 0x11, Filter (Read/Write)

Bit 7	Bit 6	Bit 5	Bit 4	Bit 3	Bit 2	Bit 1	Bit 0
HPF[3:0]				0	LPF[2:0]		

LPF Bits

The three LPF bits define the low-pass filter pole (see Table 5).

HPF Bits

The four HPF bits define the high-pass filter pole (see Table 6).

DATA READY

Table 15. Register 0x12, DATA_READY (Read/Write)

Bit 7	Bit 6	Bit 5	Bit 4	Bit 3	Bit 2	Bit 1	Bit 0
0	0	0	0	0	0	Sync[1:0]	

Sync Bits

Set the sync bits to 01 to generate a data ready interrupt at the SYNC/ASEL pin when new data becomes available.

Table 16. SYNC Pin Functions

Bit 1	Bit 0	Description
X	0	Read for analog enable
0	1	Data ready out, high until read

RECOMMENDED SOLDERING PROFILE

Figure 34 and Table 17 provide details about the recommended soldering profile.

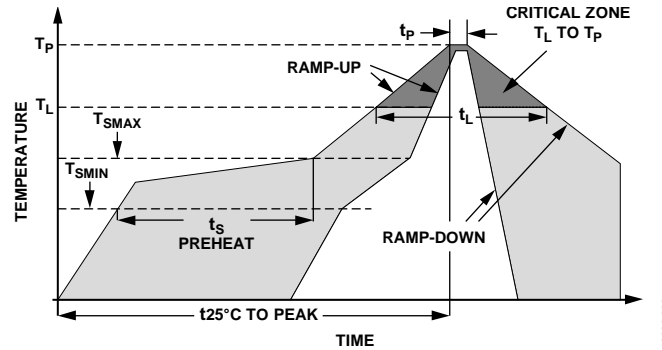

Figure 34. Recommended Soldering Profile

Table 17. Recommended Soldering Profile^{1,2}

Profile Feature	Condition	
	Sn63/Pb37	Pb-Free
Average Ramp Rate from Liquid Temperature (T _L) to Peak Temperature (T _P)	3°C/sec maximum	3°C/sec maximum
Preheat		
Minimum Temperature (T _S MIN)	100°C	150°C
Maximum Temperature (T _S MAX)	150°C	200°C
Time from T _S MIN to T _S MAX (t _S)	60 seconds to 120 seconds	60 seconds to 180 seconds
T _S MAX to T _L Ramp-Up Rate	3°C/second maximum	3°C/second maximum
Liquid Temperature (T _L)	183°C	217°C
Time Maintained Above T _L (t _L)	60 seconds to 150 seconds	60 seconds to 150 seconds
Peak Temperature (T _P)	240 + 0/-5°C	260 + 0/-5°C
Time of Actual T _P - 5°C (t _P)	10 seconds to 30 seconds	20 seconds to 40 seconds
Ramp-Down Rate	6°C/sec maximum	6°C/sec maximum
Time 25°C to Peak Temperature	6 minutes maximum	8 minutes maximum

¹ Based on JEDEC Standard J-STD-020D.1.

² For best results, the soldering profile should be in accordance with the recommendations of the manufacturer of the solder paste used.

PCB FOOTPRINT PATTERN

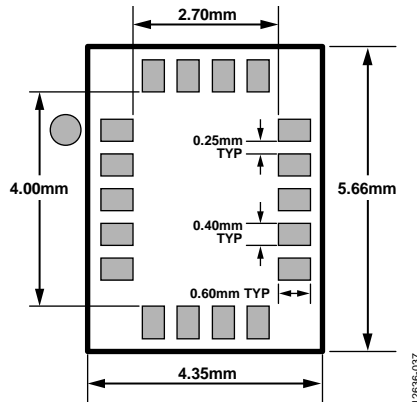

Figure 35. PCB Footprint Pattern and Dimensions

OUTLINE DIMENSIONS

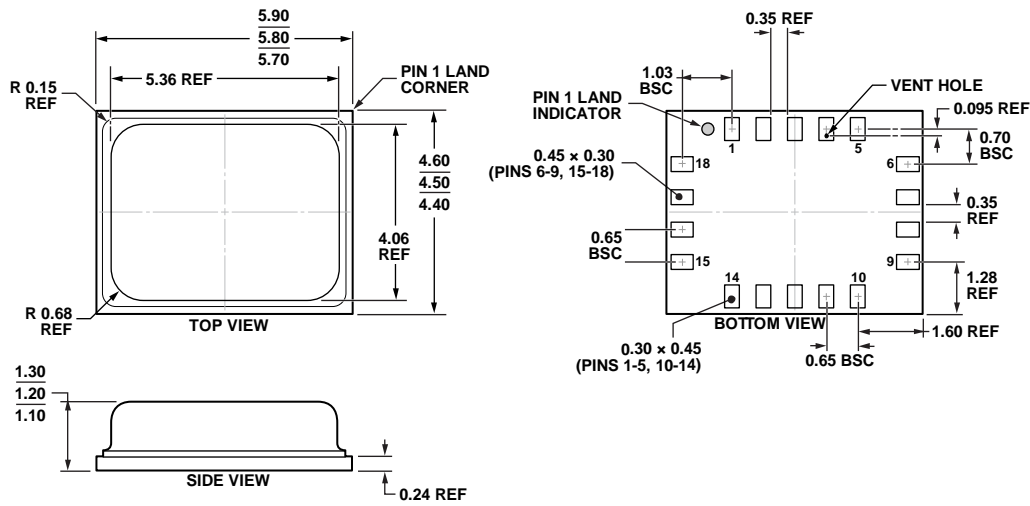

Figure 36. 18-Terminal Chip Array Small Outline No Lead Cavity [LGA_CAV]
 5.80 mm x 4.50 mm Body
 (CE-18-2)
 Dimensions shown in millimeters

04-26-2012-A

ORDERING GUIDE

Model ¹	Temperature Range	Package Description	Package Option
ADXRS290BCEZ	-25°C to +85°C	18-Terminal Chip Array Small Outline No Lead Cavity [LGA_CAV]	CE-18-2
ADXRS290BCEZ-RL	-25°C to +85°C	18-Terminal Chip Array Small Outline No Lead Cavity [LGA_CAV]	CE-18-2
ADXRS290BCEZ-RL7	-25°C to +85°C	18-Terminal Chip Array Small Outline No Lead Cavity [LGA_CAV]	CE-18-2
EVAL-ADXRS290Z		Breakout Evaluation Board	
EVAL-ADXRS290Z-M		Analog Devices Inertial Sensor Evaluation System, which includes a socket version of the satellite (ADXRS290-S) board	
EVAL-ADXRS290Z-S		ADXRS290 Satellite, Standalone Socket Version	
EVAL-ADXRS290Z-M2		Analog Devices Inertial Sensor Evaluation System, which includes a soldered version of the satellite (ADXRS290-S2) board	
EVAL-ADXRS290Z-S2		ADXRS290 Satellite, Standalone Soldered Version	

¹ Z = RoHS Compliant Part.

X-ON Electronics

Largest Supplier of Electrical and Electronic Components

Click to view similar products for [Gyroscopes](#) category:

Click to view products by [Analog Devices](#) manufacturer:

Other Similar products are found below :

[ICG-1020S](#) [LY510ALHTR](#) [LPY530AL](#) [ADIS16136AMLZ](#) [ADIS16260BCCZ](#) [ADIS16265BCCZ](#) [ADXRS290BCEZ](#) [ADXRS450BEYZ](#)
[ADXRS620BBGZ](#) [ADXRS623BBGZ](#) [ADXRS623BBGZ-RL](#) [ADXRS646BBGZ](#) [ADXRS646TBGZ-EP](#) [ADXRS649BBGZ](#)
[ADXRS652BBGZ](#) [ADXRS652BBGZ-RL](#) [ADXRS800WBRGZ](#) [SCC1300-D02-05](#) [SCC1300-D04-05](#) [ADXRS620BBGZ-RL](#) [L20G20ISTR](#)
[ISZ-2510](#) [I3G4250DTR](#) [L2G2ISTR](#) [LPR4150AL](#) [LPY510AL](#) [GYPRO2300](#) [GYPRO2300LD](#) [GYPRO3300](#)