



# **ADSP-SC584 EZ-Board® Evaluation System Manual**

# Contents

1	Preface	8
1.1	Product Overview	8
1.2	Purpose of This Manual	11
1.3	Intended Audience	11
1.4	Manual Contents	12
1.5	What's New in This Manual	12
1.6	Technical Support	12
1.7	Supported Processors	13
1.8	Supported Tools	13
1.9	Product Information	13
1.9.1	Analog Devices Web Site	13
1.9.2	EngineerZone	13
2	Using ADSP-SC584 EZ-Board	15
2.1	Package Contents	16
2.2	ADSP-SC584 EZ-Board	16
2.3	Default Configuration	16
2.4	EZ-Board Installation	17
2.5	EZ-Board Session Startup	17
2.6	Evaluation License	19
2.7	DDR2 Memory	19
2.8	SPI Flash	20
2.9	SPI EEPROM Interface	20
2.10	Audio Interface	20
2.11	Microphone Interface	21
2.12	A2B Interface	21
2.13	S/PDIF Interface	22
2.14	Housekeeping ADC	22
2.15	CAN Interface	22
2.16	UART Interface	23
2.17	Ethernet Interface	23
2.18	USB Interface	24
2.19	Link Ports Interface	24
2.20	Current Monitor Interface	24
2.21	Programmable Oscillator	25
2.22	Debug Interface	25
2.23	Power-On-Self Test	25
2.24	Expansion Interface	25
2.25	Power Architecture	26
2.26	Power Measurements	26
2.27	Example Programs	26

2.28	Reference Design Information	27
3	ADSP-SC584 EZ-Board Hardware Reference	28
3.1	System Architecture	28
3.2	Software-Controlled Switches (SoftConfig)	29
3.2.1	Overview of SoftConfig	30
3.2.2	SoftConfig on the ADSP-SC584 EZ-Board	32
3.2.3	Programming SoftConfig Switches	33
3.3	Push Buttons and Switches	38
3.3.1	Boot Mode Select Switch (SW1)	38
3.3.2	Reset Push Button (SW2)	39
3.3.3	GPIO Push Buttons (SW3-4 and SW9)	39
3.3.4	Rotary Encoder With Momentary Switch (SW5)	39
3.3.5	JTAG Interface Switches (SW6-7)	39
3.3.6	CAN Wake Switch (SW8)	41
3.4	Jumpers	41
3.4.1	Isolated Transformer Jumper (JP1)	41
3.4.2	S/PDIF Loopback Jumper (JP2)	42
3.4.3	CAN INH Jumper (JP3)	42
3.4.4	Regulator Jumper (JP4)	42
3.4.5	HADC Jumpers (P25)	42
3.4.6	Power Jumpers (P17-18, P20-21, P24)	43
3.5	LEDs	43
3.5.1	SYS_FAULT LED (LED1)	43
3.5.2	USB to UART Activity LEDs (LED2-3)	44
3.5.3	Ethernet Link LED (LED4-5)	44
3.5.4	Ethernet Activity LED (LED6)	44
3.5.5	A2B Interrupt LEDs (LED7-8)	44
3.5.6	Power LED (LED9)	44
3.5.7	GPIO LEDs (LED10-17)	44
3.5.8	Reset LED (LED22)	45
3.5.9	Ethernet LEDs (LED23-26)	45
3.6	Connectors	45
3.6.1	S/PDIF Optical Tx Connector (J1)	46
3.6.2	CLKIN0 Connector (J2)	46
3.6.3	Audio Input_Output Connector (J3)	46
3.6.4	Ethernet Connector (J4, J7)	47
3.6.5	CAN Connectors (J5-J6)	47
3.6.6	Link Port/JTAG Connectors (J8-J9)	47
3.6.7	S_PDIF Optical Rx Connector (J10)	48
3.6.8	Audio Output Connector (J11)	48
3.6.9	S/PDIF Digital Connector (J12)	48
3.6.10	MLB Connector (J13)	48
3.6.11	Headphone Connector (J14)	49
3.6.12	HADC Input Connectors (J15-J17, J19)	49

3.6.13	JTAG Connector (P1)	49
3.6.14	SigmaStudio Connector (P2)	49
3.6.15	TWI0_SPI2 Connector (P3)	49
3.6.16	TRACE and JTAG Connector (P5)	49
3.6.17	USB to UART Connector (P7)	50
3.6.18	A2B Connectors (P9-P11)	50
3.6.19	Engine RPM Connectors (P12)	50
3.6.20	Microphone Connectors (P13-P16)	50
3.6.21	Power Connector (P22)	51
3.6.22	USB Connectors (P23)	51
3.6.23	Power Connector (P27)	51
3.6.24	Expansion Interface III Connectors (P1A-C)	51
4	Appendix A - Bill Of Materials	53
5	Appendix B - Schematic	72

## Copyright Information

© 2015 Analog Devices, Inc., ALL RIGHTS RESERVED. This document may not be reproduced in any form without prior, express written consent from Analog Devices, Inc.

## Disclaimer

Analog Devices, Inc. reserves the right to change this product without prior notice. Information furnished by Analog Devices is believed to be accurate and reliable. However, no responsibility is assumed by Analog Devices for its use; nor for any infringement of patents or other rights of third parties which may result from its use. No license is granted by implication or otherwise under the patent rights of Analog Devices, Inc.

## Trademark and Service Mark Notice

The Analog Devices logo, CrossCore, A<sup>2</sup>B, EngineerZone, EZ-Board, EZ-KIT Lite and VisualDSP++ are registered trademarks of Analog Devices, Inc. Blackfin, Blackfin+, SHARC, SHARC+ and SigmaStudio are trademarks of Analog Devices, Inc. All other brand and product names are trademarks or service marks of their respective owners.

## Regulatory Compliance

The ADSP-SC584 EZ-Board is designed to be used solely in a laboratory environment. The board is not intended for use as a consumer end product or as a portion of a consumer end product. The board is an open system design which does not include a shielded enclosure and therefore may cause interference to other electrical devices in close proximity. This board should not be used in or near any medical equipment or RF devices.

The ADSP-SC584 EZ-Board is in the process of being certified to comply with the essential requirements of the European EMC directive 2004/108/EC and therefore carries the "CE" mark.



The ADSP-SC584 EZ-Board contains ESD (electrostatic discharge) sensitive devices. Electrostatic charges readily accumulate on the human body and equipment and can discharge without detection. Permanent damage may occur on devices subjected to high-energy discharges. Proper ESD precautions are recommended to avoid performance degradation or loss of functionality. Store unused EZ-Boards in the protective shipping package.





# 1 Preface

Thank you for purchasing the ADSP-SC584 EZ-Board®, Analog Devices, Inc. evaluation system for the ADSP-SC58x family of SHARC® processors.

The ADSP-SC584 processor is based on the SHARC+™ core dual processor with the ARM® Cortex-A5™ processor core and is designed for a wide array of markets, from automotive and pro-audio to industrial-based applications that require high floating-point performance. The EZ-Board is shipped with all of the necessary hardware—you can start the evaluation immediately. The package contains the standalone evaluation board, CE-approved power supply, and USB cable. The EZ-KIT Lite® version ships with the ICE-1000 emulator, while the EZ-Board version requires the customer to provide an ICE-1000 or ICE-2000 emulator.

Expansion Interface III connectors are provided for interfacing with additional extender boards to provide LCD, camera, video, and audio.

Traditional mechanical switches for changing the board's factory setup have been removed in favor of I2C controlled software switches. The only remaining mechanical switches are the boot mode switch, JTAG configuration switches, and push buttons.

The evaluation board is designed to be used in conjunction with the -CrossCore® Embedded Studio (CCES) development tools to test capabilities of the ADSP-SC58x processors. The development environment aids advanced application code development and debug, such as:

- Create, compile, assemble, and link application programs written in C++, C, and assembly
- Load, run, step, halt, and set breakpoints in application programs
- Read and write data and program memory
- Read and write core and peripheral registers

## 1.1 Product Overview

The board features:

- Analog Devices ADSP-SC584 processor
  - 349-ball 19 mm x 19 mm package
  - 25 MHz CLKIN0 and CLKIN1 programmable oscillator
- DDR2 memory
  - One 128M x 16-bit (2G bit)
  - Micron MT47H128M16RT-25
- SPI Flash



- 128M bit
- Single, dual, and quad mode support
- Windbond W25Q128FV
- SPI EEPROM
  - 1K bit
  - Microchip 25LC010A
- Ethernet PHY (EMAC0)
  - 10/100/1000 Mb/s
  - Texas Instruments DP83865
  - RJ45 connector
- Ethernet PHY (EMAC0)
  - 10/100 Mb/s
  - Broadcom BCM89810
  - RJ45 connector
- Audio
  - Analog Devices ADAU1962A 12-channel, high-performance, 24-bit digital-to-analog converter
  - Analog Devices ADAU1979 quad analog-to-digital converter
  - Analog Devices ADAU1977 quad analog-to-digital converter with diagnostics
  - 12 RCA connectors configurable as either 12 outputs or 8 outputs and 4 inputs
  - Four 0.1" microphone connectors
  - Headphone audio out connector
  - SPDIF in/out optical connectors
  - SPDIF in/out coax connectors
- Automotive Audio Bus
  - AD2410 Automotive Audio Bus A2B Transceiver configured as master
  - AD2410 Automotive Audio Bus A2B Transceiver configured as master/slave
  - Three 2-pin DuraClik connectors
- Universal Asynchronous Receiver/Transmitter (UART0)
  - FTDI FT232RQ UAB to UART converter
  - USB micro AB connector

- Controller Area Network (CAN) interfaces
  - CAN0—NXP TJA1145 high speed transceiver for partial networking
  - CAN1—NXP TJA1055 enhanced fault tolerant transceiver
  - Two RJ11 connectors
- USB interfaces
  - USB OTG micro AB connector
- HADC
  - 0.1" and SMB connectors
- RESET controller
  - Analog Devices ADM6315 microprocessor supervisory circuits
- Debug (JTAG/SWD/SWO/TRACE) interface
  - JTAG/SWD/SWO 10-pin 0.05" header for use with Analog Devices emulators
  - TRACE/JTAG/SWD 38-pin Mictor header
- Power measurements
  - INA3221 to measure 1.8V, VDD\_INT, and VDD\_EXT
- LEDs
  - 13 LEDs: one power (green), one board reset (red), six Ethernet (green and amber), one SYS\_FAULT (red), and eight general-purpose (amber)
- Push buttons
  - Four push buttons: one reset, and three IRQ/Flag
- Expansion Interface III connectors (EI3)
  - SMC0
  - PPI
  - SPORT
  - SPI
  - UART
  - TWI
  - TMR
  - GPIOs
  - PWR\_IN
  - GND/3.3V output

- External power supply
  - CE compliant
  - 12V @ 1.5 amps
- Other features
  - SigmaStudio™ connectors
  - 0.05-ohm resistors for processor current measurement

For information about the hardware components of the EZ-Board, refer to [Appendix A - Bill Of Materials](#)

## 1.2 Purpose of This Manual

The ADSP-SC584 EZ-Board Evaluation System Manual provides instructions for installing the product hardware (board). The text describes operation and configuration of the board components and provides guidelines for running your own code on the ADSP-SC584 EZ-Board. Finally, a schematic and a bill of materials are provided for reference.

## 1.3 Intended Audience

The primary audience for this manual is a programmer who is familiar with an ARM Cortex-A5-based processor core and a SHARC-based processor core.

The ADSP-SC58x family of SHARC+ processors is based on the ARM Cortex-A5/SHARC processor core with floating-point unit and integrated SRAM memory, flash memory, accelerators, and peripherals.

The applicable documentation for programming the ARM Cortex-A5 processor core includes:

- Cortex-A5 Devices Generic User Guide
- CoreSight ETM-A5 Technical Reference Manual
- Cortex-A5 Technical Reference Manual

For additional information on this Analog Devices processor, see the ADSP-SC58x SHARC+ Processor Hardware Reference. This document describes the ARM Cortex-A5 processor core and memory architecture used on the ADSP-SC58x processor, but does not provide detailed programming information for the ARM core.

For more information about programming the ARM core, visit the ARM Information Center:

- <http://infocenter.arm.com/help/>

## 1.4 Manual Contents

The manual consists of:

### Chapter 1 [Using ADSP-SC584 EZ-Board](#)

- Describes EZ-Board functionality from a programmer's perspective and provides a simplified memory map of the processor.

### Chapter 2 [ADSP-SC584 EZ-Board Hardware Reference](#)

- Provides information about the EZ-Board hardware components.

### Appendix A [ADSP-SC584 EZ-Board Bill Of Materials](#)

- Provides a list of hardware components used to manufacture the EZ-Board.

### Appendix B [ADSP-SC584 EZ-Board Schematic](#)

- Lists the resources for board-level debugging.

## 1.5 What's New in This Manual

This is the first edition (Revision 1.0) of the ADSP-SC584 EZ-Board Evaluation System Manual.

## 1.6 Technical Support

You can reach Analog Devices processors and DSP technical support in the following ways:

- Post your questions in the processors and DSP support community at EngineerZone®:  
<http://ez.analog.com/community/dsp>
- Submit your questions to technical support directly at:  
<http://www.analog.com/support>
- E-mail your questions about processors and processor applications to:  
[processor.support@analog.com](mailto:processor.support@analog.com) or [processor.china@analog.com](mailto:processor.china@analog.com) (Greater China support)
- Contact your Analog Devices sales office or authorized distributor.  
[www.analog.com/adi-sales](http://www.analog.com/adi-sales)
- Send questions by mail to:

Processors and DSP Technical Support  
Analog Devices, Inc.  
Three Technology Way

P.O. Box 9106  
Norwood, MA 02062-9106  
USA

## 1.7 Supported Processors

This evaluation system supports Analog Devices ADSP-SC584 processors.

## 1.8 Supported Tools

Information on supported tools for the ADSP-SC584 EZ-Board and the ADSP-SC58x family of processors is available at: <http://www.analog.com/sc584ezboard>

## 1.9 Product Information

Product information can be obtained from the Analog Devices Web site and the online help system.

### 1.9.1 Analog Devices Web Site

The Analog Devices Web site, [www.analog.com](http://www.analog.com), provides information about a broad range of products— analog integrated circuits, amplifiers, converters, and digital signal processors.

To access a complete technical library for each processor family, go to [http://www.analog.com/processors/technical\\_library](http://www.analog.com/processors/technical_library). The manuals selection opens a list of current manuals related to the product as well as a link to the previous revisions of the manuals. When locating your manual title, note a possible errata check mark next to the title that leads to the current correction report against the manual.

Also note, [myAnalog.com](http://myAnalog.com) is a free feature of the Analog Devices Web site that allows customization of a Web page to display only the latest information about products you are interested in. You can choose to receive weekly e-mail notifications containing updates to the Web pages that meet your interests, including documentation errata against all manuals. [myAnalog.com](http://myAnalog.com) provides access to books, application notes, data sheets, code examples, and more.

Visit [myAnalog.com](http://myAnalog.com) (found on the Analog Devices home page) to sign up. If you are a registered user, just log on. Your user name is your e-mail address.

### 1.9.2 EngineerZone

EngineerZone is a technical support forum from Analog Devices. It allows you direct access to ADI technical support engineers. You can search FAQs and technical information to get quick answers to your embedded processing and DSP design questions.

Use EngineerZone to connect with other DSP developers who face similar design challenges. You can also use this open forum to share knowledge and collaborate with the ADI support team and your peers. Visit <http://ez.analog.com> to sign up.

## 2 Using ADSP-SC584 EZ-Board

This chapter provides information to assist you with development of programs for the ADSP-SC584 EZ-Board evaluation system.

The following topics are covered.

- Package Contents
- ADSP-SC584 EZ-Board
- Default Configuration
- EZ-Board Installation
- EZ-Board Session Startup
- Evaluation License
- DDR2 Memory
- SPI Flash
- SPI EEPROM Interface
- Audio Interface
- Microphone Interface
- A2B Interface
- S/PDIF Interface
- Housekeeping ADC
- CAN Interface
- UART Interface
- Ethernet Interface
- USB Interface
- Link Ports Interface
- Current Monitor Interface
- Programmable Oscillator
- Debug Interface
- Power-On-Self Test
- Expansion Interface
- Power Architecture

- [Power Measurements](#)
- [Example Programs](#)
- [Reference Design Information](#)

## 2.1 Package Contents

Your ADSP-SC584 EZ-Board package contains the following items.

- ADSP-SC584 EZ-Board PCB
- Universal 12V DC power
- Ethernet cable
- USB A to micro B cable
- USB micro A to A receptacle cable
- ICE-1000 (only in the EZ-KIT Lite version)
- Standoffs and screws in a bag
- Release note

Contact the vendor where you purchased your EZ-Board or contact Analog Devices, Inc. if any item is missing.

## 2.2 ADSP-SC584 EZ-Board

The ADSP-SC584 EZ-KIT Lite is shipped with an ICE-1000 emulator. When the product is not shipped with the debugger, it is referred to as the ADSP-SC584 EZ-Board.



The EZ-Board requires an ICE-1000 or ICE-2000 emulator.

## 2.3 Default Configuration

The ADSP-SC584 EZ-Board is designed to run as a standalone unit.

The image below shows the default jumper settings, connector locations, and LEDs used in installation. Confirm that your board is in the default configuration before using the board.



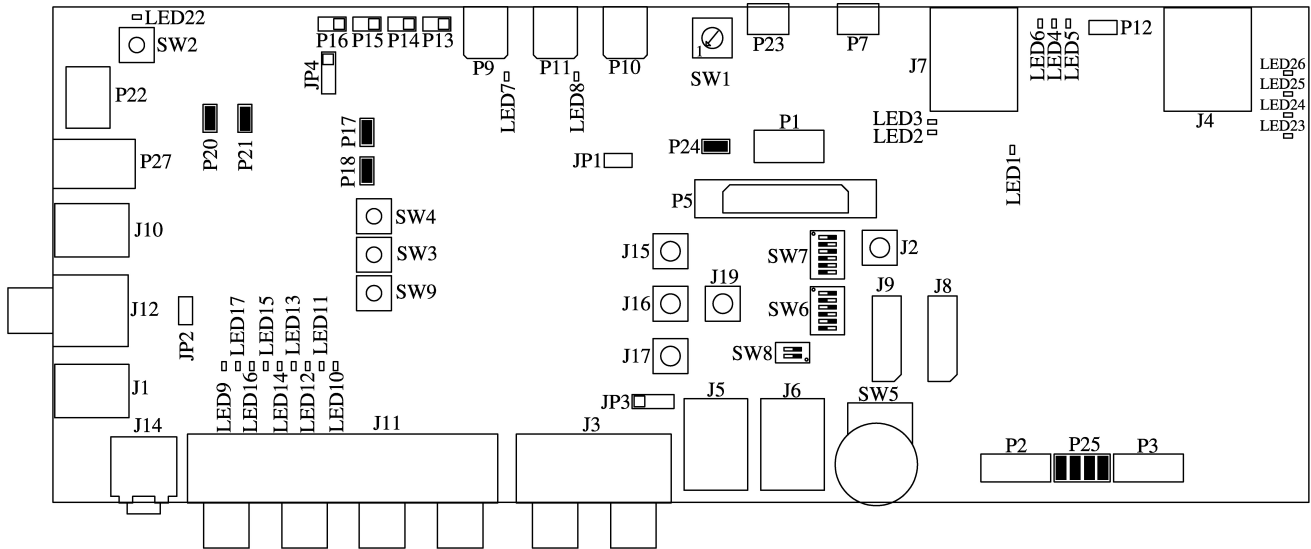

## 2.4 EZ-Board Installation

It is assumed that the CrossCore Embedded Studio software is installed and running on your PC. Follow these instructions to ensure correct operation of the product software and hardware.

**Step 1:** Connect an emulator to the EZ-Board.

- Plug one side of the included USB cable into the USB connector of the emulator. Plug the other side into a USB port of the PC.
- The status LED (labeled STATUS) lights up green if the connection with the PC is working and the appropriate Windows driver is installed. Please refer to the appropriate emulator manual if the status LED does not turn on.
- Attach the emulator header (J2) on the bottom of the ICE-1000 to the P3 connector on the EZ-Board.



**Step 2:** Attach the provided cord and appropriate plug to the 5V power adaptor.

- Plug the jack-end of the assembled power adaptor into the power connector P22 (labeled 5V) on the EZ-Board.
- Plug the other side of the power adaptor into a power outlet. The power LED LED9 (labeled POWER) lights green when power is applied to the board.

## 2.5 EZ-Board Session Startup

It is assumed that the CrossCore Embedded Studio software is installed and running on your PC.

- Note: If you connect the board or emulator first (before installing CCES) to the PC, the Windows driver wizard may not find the board drivers.

- Navigate to the CCES environment through the **Start** menu. Note that CCES is not connected to the target board.
- Use the Debug Configurations wizard to connect to the EZ-Board. If a debug configuration exists already, select the appropriate -configuration and click **Debug**. Go to step 8.
- To create a debug configuration, do one of the following:
  - Click the down arrow next to the bug icon  , select **Debug Configurations**.
  - Choose **Run > Debug Configurations**.
  - The **Debug Configuration** dialog box appears.
  - Select **Application with CrossCore Debugger** and click  (**New launch configuration**). The **Select Processor** page of the **Session Wizard** appears.
  - Ensure **SHARC** is selected in **Processor family**. In **Processor type**, select **ADSP-SC584**. Click **Next**. The **Select Connection Type** page of the **Session Wizard** appears.
  - Select **Emulator** and click **Next**.
  - The **Select Platform** page of the **Session Wizard** appears.
  - Choose the type of emulator that is connected to the EZ-Board.
  - Click **Finish** to close the wizard. The new debug configuration is created and added to the Debug Configurations list.
  - In the **Name** edit box, users can select an appropriate name to describe the configuration, otherwise a default name is provided.
  - In the **Program(s) to load** section, choose the program to load (if the appropriate program is not already populated) when connecting to the board. If not loading any program upon connection to the target, do not make any changes.

**NOTE:**

Notice that by default there is an application loaded to Core 0 that is not the application created by the user. This is a preload application that is used to set up external memory since Core 0 applications are loaded to L3 memory by default. This preload can be changed if needed but will work for most applications. User applications loaded after a preload should NOT reset as they may undo some of what the preload has already set up.

- While connected to the target, there is no way to choose a program to download. To load a program once connected, terminate the session and then load the new program.
- To delete a configuration, go to the **Debug Configurations** dialog box and select the configuration to delete. Click  and choose **Yes** when asked if you wish to delete the selected launch configuration. Then **Close** the dialog box.

- To disconnect from the target board, click the terminate button  or choose **Run > Terminate**. To delete a session, choose **Target > Session > Session List**. Select the session name from the list and click **Delete**. Click **OK**.
- The default configurations that show up in the CCES Debug Configurations wizard are for JTAG mode debugging only.

## 2.6 Evaluation License

When starting CCES for the first time, you are prompted to install a license with a serial number or to enable evaluation of the product without a serial number. In the box that contains the EZ-Board is a business card with a serial number on it. When prompted, choose "I have a serial number that I would like to activate" and enter the serial number shown on the card. If the evaluation license is installed but not activated, it allows 10 days of unrestricted use and then becomes disabled. The license can be re-enabled by activation. Once activated, the evaluation license offers unrestricted use for a defined period and then becomes disabled until an additional license is installed.

 if installing CCES without using a serial number, you will be limited to 90 days.

An evaluation license can be upgraded to a full license. Licenses can be purchased from:

- Analog Devices directly. Call (800) 262-5645 or 781-937-2384 or go to: <http://www.analog.com/buyonline>.
- Analog Devices, Inc. local sales office or authorized distributor. To locate one, go to: [www.analog.com/adi-sales](http://www.analog.com/adi-sales).

## 2.7 DDR2 Memory

There is one Dynamic Memory Controllers (DMC) on the ADSP-SC584 processor. It connects to a 2Gb Micron MT47H128M16 chip through the Double Data Rate Synchronous Dynamic Random-Access Memory (DDR2 SDRAM) controller. The DDR2 memory controller on the processor and the DDR2 memory chip are powered by the on-board 1.8V regulator. Data is transferred between the processor and DDR2 on both the rising and falling edges of the DDR2 clock. The DDR2 controller on the processor can operate up to a maximum clock frequency of 400 MHz.

With a CCES session running and connected to the EZ-Board through an emulator, the DDR3 registers are configured automatically each time a program is loaded through the use of the preload program.

An example program is included in the ADSP-SC584 Board Support Package to demonstrate how to set up and access the DDR2 interface. For more information on how to initialize the registers after a reset, refer to the hardware reference manual.

## 2.8 SPI Flash

The ADSP-SC584 processor has three SPI interfaces: SPI0, SPI1, and SPI2. SPI2 is connected to a Winbond W25Q128FV 128 Mb serial flash memory with dual and quad SPI support. This flash is used for booting and scratchpad space.

Quad mode is enabled by default. The processor flag signals PC\_06 (SPI2\_SEL1), PC\_04 (SPI2\_D2), and PC\_05 (SPI2\_D3) are connected by default and can be disconnected by using SoftConfig. Refer to [Software-Controlled Switches \(SoftConfig\)](#) for more information.

For more information, refer to the SPI flash example in the POST, which is included in the ADSP-SC584 Board Support Package.

## 2.9 SPI EEPROM Interface

The ADSP-SC584 processor has three SPI interfaces: SPI0, SPI1, and SPI2. SPI0 is connected to a Microchip 25LC010A 1 Kb serial flash electronically erasable programmable only memory. This flash is used for storing configuration data for EAVB.

The SPI EEPROM is disabled by default. The processor flag signal PD\_01 (SPI0\_SEL2) is not connected by default and can be connected by using SoftConfig. Refer to [Software-Controlled Switches \(SoftConfig\)](#) for more information.

For more information, refer to the SPI flash EEPROM example in the POST, which is included in the ADSP-SC584 Board Support Package.

## 2.10 Audio Interface

The ADSP-SC584 EZ-Board contains an ADC and a DAC. The ADAU1979 is a quad analog-to-digital converter. The ADC incorporates four high-performance analog-to-digital converters. This converter uses a multi-bit sigma-delta architecture with continuous time front-end for low EMI. The ADAU1979 contains an SPI port which is used as a control port to adjust volume and many other parameters. The ADAU1962A is a 12-channel high-performance digital-to-analog converter. The DAC uses a multi-bit sigma-delta architecture and is designed for low EMI. This converter contains an SPI port which is used as a control port to adjust volume and other parameters.

The EZ-Board is configurable for either 12 outputs or 8 outputs and 4 inputs. Configuration is performed through SoftConfig. The audio channels are available as single-ended RCA connectors J6 and J16. One output channel is also available on a 3.5mm headphone jack (J21).

For more information, refer to the audio example in the POST, which is included in the ADSP-SC584 Board Support Package.

## 2.11 Microphone Interface

The ADSP-SC584 EZ-Board contains an ADC. The ADAU1977 is a quad analog-to-digital converter with diagnostics. The ADC incorporates four high-performance analog-to-digital converters. This converter uses a multi-bit sigma-delta architecture with continuous time front-end for low EMI. The ADC can be connected to the electret microphone directly and provide the bias for powering the microphone. Built-in diagnostic circuitry detects faults on input lines and includes comprehensive diagnostics for faults on microphone inputs. The ADAU1977 contains an SPI port which is used as a control port to adjust volume and many other parameters.

For more information, refer to the audio example in the POST, which is included in the ADSP-SC584 Board Support Package.

## 2.12 A2B Interface

The Automotive Audio Bus (A<sup>2</sup>B) provides a multi-channel, I2S/TDM link over distances of up to 10 meters between nodes. It embeds bi-directional synchronous data (for example digital audio), clock and synchronization signals onto a single differential wire pair. A2B supports a direct point-to-point connection and allows multiple, daisy chained nodes at different locations to contribute or consume time division multiplexed channel content. A<sup>2</sup>B is a single-master, multiple-slave system where the transceiver chip at the host controller is the master. It generates clock, synchronization and framing for all slave nodes. The master A<sup>2</sup>B chip is programmable over a control bus (I2C) for configuration and read back. An extension of this control bus is embedded in the A<sup>2</sup>B data stream allowing direct access of registers and status information on slave nodes as well as I2C-to-I2C communication over distance.

ADSP-SC584 EZ-Board contains three DuraClik connectors for interfacing with A2B devices. There are two AD2410 devices on the board. One is configured as a master and the other is configurable as either a master or slave.

For more information, refer to the audio example in the POST, which is included in the ADSP-SC584 Board Support Package.

## 2.13 S/PDIF Interface

The ADSP-SC584 processor has two built-in S/PDIF transmitters and receivers for digital audio applications. The EZ-Board supports one S/PDIF interface and connects to the transmitter and receiver through RCA and optical connectors J17, J15, J17, and J4.

The transmit and receive pins of the S/PDIF are connected to DAI pins through SoftConfig. DAI0\_PIN19 is connected to S/PDIF receive and DAI0\_PIN20 is connected to S/PDIF transmit. Refer to [Software-Controlled Switches \(SoftConfig\)](#) for more information.

For more information, refer to the S/PDIF example in the POST, which is included in the ADSP-SC584 Board Support Package.

## 2.14 Housekeeping ADC

The ADSP-SC584 processor provides eight housekeeping ADC inputs—HADC0\_VIN0 through HADC0\_VIN7. The EZ-Board connects HADC0\_VIN0 to pin 1, HADC0\_VIN1 to pin 4, HADC0\_VIN2 to pin 5 and HADC0\_VIN3 to pin 8 of an eight-position 0.1" header (P25). P25 has the 3.3V voltage domain on pin 1, 1.8V voltage domain on pin 3, VDD\_INT voltage domain on pin 6 and 2.16V ( $12V \times (22K / (100K + 22K))$ ) on pin 7, allowing a jumper to connect the voltage back to the processor.

HADC0\_VIN4 through HADC0\_VIN5 are connected to SMB connectors (J15 - J17). HADC0\_VIN7 are connected to SMB connectors (J19) through a 1:1 buffer.

For more information, refer to the HADC example in the POST, which is included in the ADSP-SC584 Board Support Package.

## 2.15 CAN Interface

The ADSP-SC584 processor has two CAN instances. Both are used by the EZ-Board.

The Controller Area Network 0 (CAN0) interface of the EZ-Board is connected to the NXP TJA1055 /3 enhanced fault-tolerant CAN transceiver. The transceiver is attached to the CAN0 port of the ADSP-SC584 processor through an RJ-11 connector (J12). See [CAN Connectors \(J12–J13\)](#).

The CAN0 transmit, receive, and control signals are connected through the SoftConfig switches and disabled by default.

CAN0\_EN is connected to -PB\_08. CAN0\_STB is connected to PB\_02. CAN0\_ERR is connected to PB\_07. See [Software-Controlled Switches \(SoftConfig\)](#).

For more information, refer to the CAN0 example in the POST, which is included in the ADSP-SC584 Board Support Package.

The Controller Area Network 1 (CAN1) interface of the EZ-Board is connected to the NXP TJA1145 high speed CAN transceiver for partial networking. The transceiver is attached to the CAN1 and SPI0 port of the ADSP-SC584 processor through an RJ-11 connector (J13). See [CAN Connectors \(J12–J13\)](#).

The CAN1 transmit and receive signals are connected through the SoftConfig switches and enabled by default. See [Software-Controlled Switches \(SoftConfig\)](#).

For more information, refer to the CAN1 example in the POST, which is included in the ADSP-SC584 Board Support Package.

## 2.16 UART Interface

The ADSP-SC584 processor has three built-in universal asynchronous transmitters (UARTs). UART0 is connected to an FTDI, FT232RQ, USB to UART converter IC.

The UART functionality is connected by default through SoftConfig. Refer to [Software-Controlled Switches \(SoftConfig\)](#) for more information.

For more information, refer to the UART example in the POST, which is included in the ADSP-SC584 Board Support Package.

## 2.17 Ethernet Interface

The ADSP-SC584 processor has one Ethernet Media Access Controller interface. EMAC0 is configurable as 10 Mbps/100 Mbps (interfacing through RMII) or 1 Gbps (interfacing through RGMII). It supports IEEE 1588 and AVB.

On the EZ-Board, EMAC0 is connected to a Texas Instruments DP83865 PHY. It is configured to operate in RGMII-3COM mode. The PHY supports 10BASE-T, 100BASE-TX, and 1000BASE-T Ethernet protocols.

On the board, EMAC0 is also connected to a Broadcom BCM89810 PHY. It is configured to operate in RGMII mode. The PHY supports 10BASE-T and 100BASE-TX Ethernet protocols.

The selection of the PHY is performed by using SoftConfig. Refer to the [Software-Controlled Switches \(SoftConfig\)](#) section for more information.

For more information, refer to the Ethernet example in the POST, which is included in the ADSP-SC584 Board Support Package.

## 2.18 USB Interface

The ADSP-SC584 processor has one instances of the USB controller. It supports USB 2.0 HS On-The-Go (OTG). The EZ-Board provides one micro AB connector. The board supplies a maximum of 5V at 500 mA to a peripheral device when connecting to the OTG connector by enabling a FET switch. The USB controller oversees the FET switch through the USB0\_VBC signal.

For more information, refer to the USB example in the POST, which is included in the ADSP-SC584 Board Support Package.

## 2.19 Link Ports Interface

The ADSP-SC584 processor has two dedicated link ports. Each link port has a clock pin, an acknowledgment pin, and eight data pins. The ports can operate at up to 150 MHz and act as either receivers or transmitters. The ports are used to interface gluelessly to other ADSP-SC584 processors which also have the link ports pins brought out to a connector.

The EZ-Board enables access to link ports 0 and 1 through connectors J3 and J23, respectively. Two ADSP-SC584 EZ-Boards can mate gluelessly through the link port connectors using an off-the-shelf cable from Samtec. The processors communicate through the link ports, all while performing independent tasks on each of the EZ-Boards. To loopback the link port connectors on one EZ-Board to another, obtain a standard, off-the-shelf cable from Samtec. For more information, see [Link Port /JTAG Connectors \(J8-J9\)](#)

## 2.20 Current Monitor Interface

The ADSP-SC584 EZ-Board contains a Texas Instruments INA3221 triple-channel, high-side measurement, shunt, and bus voltage monitor. The INNA3221 monitors both shunt voltage drops and bus supply voltages in addition to having programmable conversion times and averaging modes for these signals. It offers both critical and warning alerts to detect out-of-range conditions for each channel. This device is connected to the ADSP-SC584 processor through TWI0. The device is used to measure the voltage levels and current draw from 1.8V (DDR2), VDD\_INT, and VDD\_EXT.

For more information, refer to the example in the POST, which is included in the ADSP-SC584 Board Support Package.



## 2.21 Programmable Oscillator

The ADSP-SC584 EZ-Board contains a Silicon Labs Si5356A I2C programmable, quad output clock generator. This device generates clocks for the CLKIN0 and CLKIN1 inputs for the ADSP-SC584 processor. It also generates the CLKIN for the ADAU1962A. When the board powers up, the CLKIN0 and CLKIN1 signals default to 25 MHz and the ADAU1962A\_CLKIN defaults to 24.576 MHz. The Si5356A connects to the ADSP-SC584 processor through TWI0. Different frequencies can be programmed into the part by using the Silicon Labs ClockBuilder desktop software.

For more information, refer to the example in the POST, which is included in the ADSP-SC584 Board Support Package.

## 2.22 Debug Interface

The EZ-Board provides a JTAG connection through a connector (P3), which is a 0.05" pitch header. A 16-bit trace connection also is available through a connector (P2), although this is not supported at this time. See [JTAG Connector \(P1\)](#) and [TRACE and JTAG Connector \(P5\)](#) for more information.

## 2.23 Power-On-Self Test

The Power-On-Self-Test (POST) program tests all EZ-Board peripherals and validates functionality as well as connectivity to the processor. Once assembled, each EZ-Board is fully tested for an extended period of time with POST. All EZ-Boards are shipped with POST burned into flash memory. The POST is executed by resetting the board and pressing the proper push button(s) sequence. The POST also can be used as a reference for a custom software design or hardware troubleshooting.

The source code for the POST program is included in the ADSP-SC584 Board Support Package along with the readme.txt file that describes how to configure the board run POST.

## 2.24 Expansion Interface

The expansion interface allows a custom-design daughter board to be tested across various hardware platforms that have the same expansion interface.

The Expansion Interface III (EI3) implemented on the ADSP-SC584 EZ-Board consists of three connectors: P1A, P1B and P1C. The connectors contain a majority of the processor's signals. For pinout information, go to [Appendix B - Schematic](#).

Limits to current and interface speed must be taken into consideration when using the expansion interface. Current for extenders connected to the EI3 connectors can be sourced from the EZ-Board; therefore, the current should be limited to 250 mA for 5V, and 300 mA from the 3.3V planes. If more current is required, a separate power connector and a regulator must be designed on the daughter card. Additional circuitry implemented on extender cards can add extra loading to signals, decreasing their maximum effective speed.



Analog Devices does not support and is not responsible for the effects of additional circuitry.

## 2.25 Power Architecture

The ADSP-SC584 EZ-Board has six primary voltage domains: 1.1V, 1.8V, 3.3V, 5V, 8.5V and 12V. The power input is a 12V wall adaptor.

The Analog Devices ADP5054 controller provides three voltage levels—3.3V for the VDD\_EXT signal and the 3.3V power requirements of the board, 1.1V for the VDD\_INT signal, as well as 1.8V for the DDR2 signal.

The voltage levels can be measured using the INA3221 IC for 3.3V, VDD\_INT, and 1.8V. Current consumption of the power rail could be measured with this same device when the corresponding jumper is removed. See [Power Measurements](#) for more information.

## 2.26 Power Measurements

Locations are provided for measuring the current draw from various power planes. Precision 0.05 ohm shunt resistors are available on the VDD\_EXT, VDD\_INT, USB0\_VBUS, and 3.3V and voltage domains. For measuring current draw, the jumper is removed, voltage across the resistor can be measured using an oscilloscope, and the value of the resistor can be measured using a precision multi-meter. Once voltage and resistance are measured, the current can be calculated by dividing the voltage by the resistance. For the highest accuracy, a differential probe should be used for measuring the voltage across the resistor.

## 2.27 Example Programs

Example programs are provided with the ADSP-SC584 Board Support Package to demonstrate various capabilities of the product.

The programs can be found in the ADSP-SC584\_EZ-Board-Rel1.0.0\examples folder. The number after the "Rel" could be higher for newer versions. Refer to a readme file provided with each example for more information.

## 2.28 Reference Design Information

A reference design info package is available for download on the Analog Devices Web site. The package provides information on the design, layout, fabrication, and assembly of the EZ-Board.

The information can be found at:<http://www.analog.com/sc584ezboard>

## 3 ADSP-SC584 EZ-Board Hardware Reference

This chapter describes the hardware design of the ADSP-SC584 EZ-Board.

The following topics are covered.

- [System Architecture](#) - Describes the board's configuration and explains how the board components interface with the processor.
- [Software-Controlled Switches \(SoftConfig\)](#) - Lists and describes the processor signals routed through the software-controlled switches.
- [Push Buttons and Switches](#) - Shows the locations and describes the push buttons and switches.
- [Jumpers](#) - Shows the locations and describes the configuration jumpers.
- [LEDs](#) - Shows the locations and describes the LEDs.
- [Connectors](#) - Shows the locations and provides part numbers for the on-board connectors. In addition, the manufacturer and part number information is provided for the mating parts.

### 3.1 System Architecture

This section describes the processor's configuration on the EZ-Board.

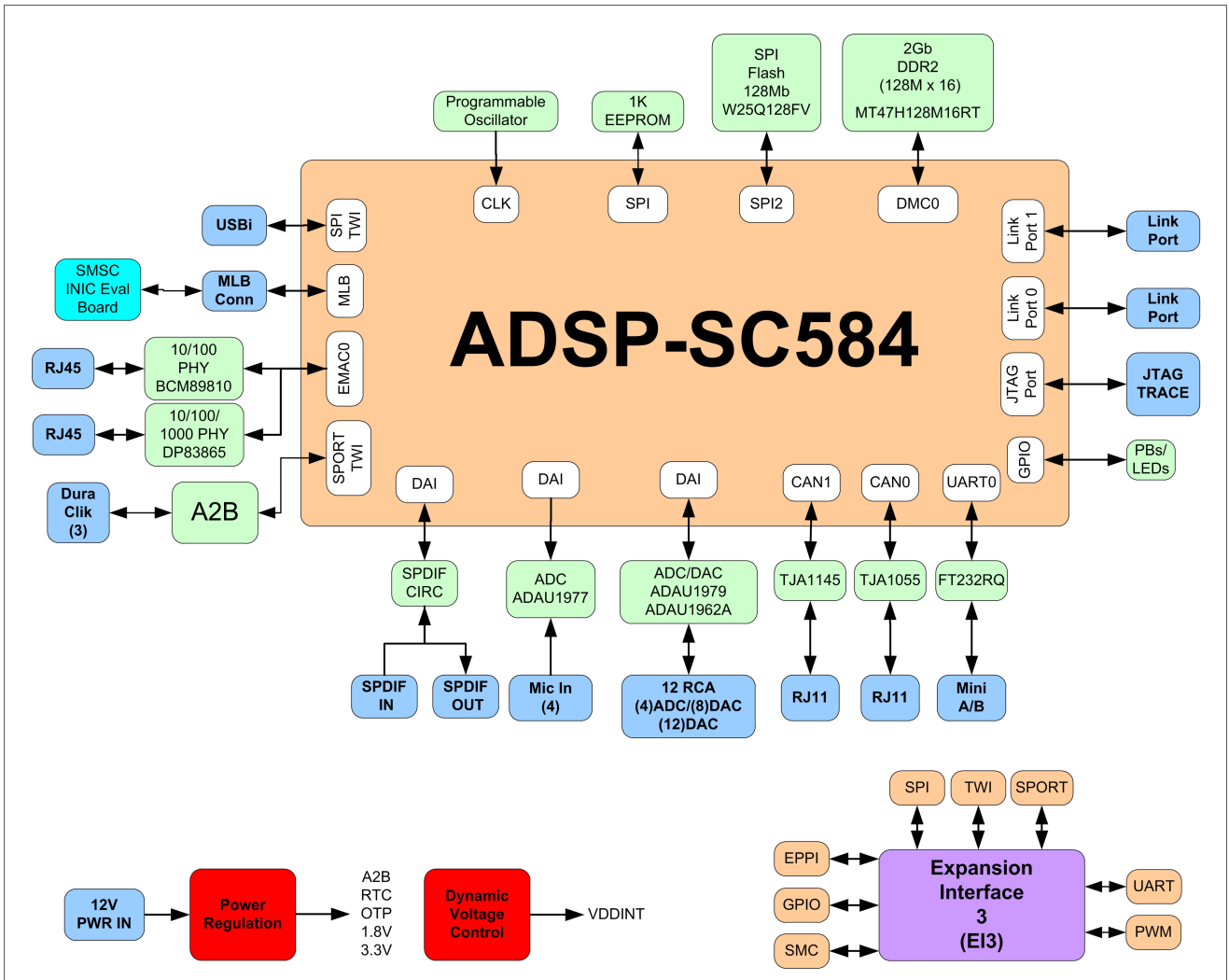

The ADSP-SC584 EZ-Board has two 25 MHz input clocks and runs at a max core clock frequency of 450 MHz. The input clock frequency can be changed through the SI5356A I2C programmable clock generator.

### 3.2 Software-Controlled Switches (SoftConfig)

On the ADSP-SC584 EZ-Board, most of the traditional mechanical switches have been replaced by I2C software-controlled switches. The remaining mechanical switches are provided for the boot mode and push buttons. Reference any SoftConfig\*.c file found in the installation directory for an example of how to set up the SoftConfig feature of the ADSP-SC584 EZ-Board through software.

The SoftConfig section of this manual serves as a reference to any user that intends to modify an existing software example. If software provided from ADI is used, there should be little need to reference this section.



Care should be taken when changing SoftConfig settings not to create a conflict with interfaces. This is especially true when connecting extender cards.

### 3.2.1 Overview of SoftConfig

In order to further clarify the use of electronic single FET switches and multi-channel bus switches, an example of each is illustrated and compared to a traditional mechanical switching solution. This is a generic example that uses the same FET and bus switch components that are on the EZ-Board.

After this generic discussion there is a detailed -explanation of the SoftConfig interface specific to the ADSP-SC584 EZ-Board.

The circuit below shows two individual FET switches (Pericom PI3A125CEX) with reference designators UA and UB. Net names ENABLE\_A and ENABLE\_B control UA and UB. The default FET switch enable settings in this example are controlled by resistors RA and RB which pull the enable pin 1 of UA and UB to ground (low). In a real example, these enable signals are controlled by the Microchip IO expander. The default pull-down resistors connect the signals EXAMPLE\_SIGNAL\_A and EXAMPLE\_SIGNAL\_B and also connect signals EXAMPLE\_SIGNAL\_C and EXAMPLE\_SIGNAL\_D. To disconnect EXAMPLE\_SIGNAL\_A from EXAMPLE\_SIGNAL\_B, the Microchip IO expander is used to change ENABLE\_A to a logic 1 through software that interfaces with the Microchip. The same procedure for ENABLE\_B would disconnect EXAMPLE\_SIGNAL\_C from EXAMPLE\_SIGNAL\_D.

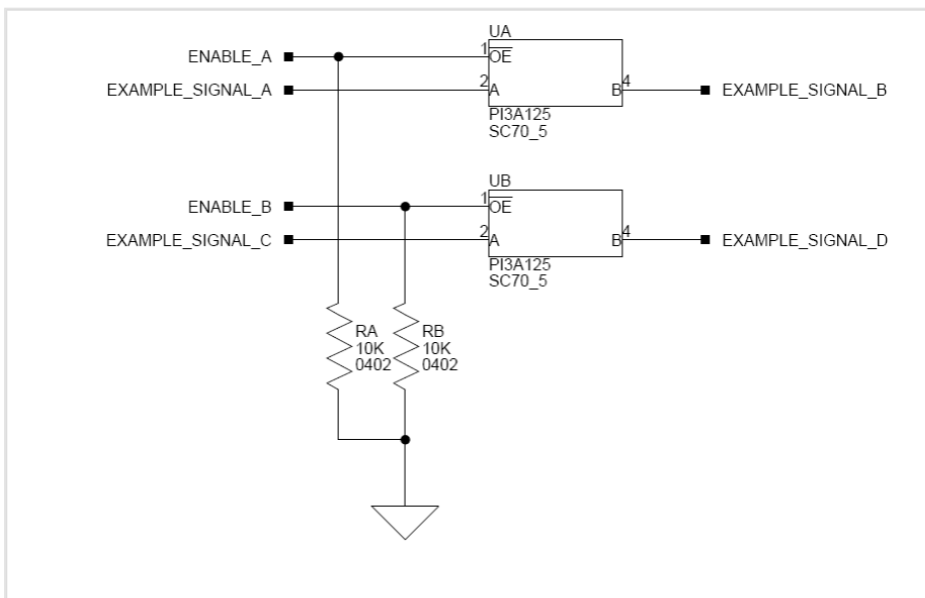

The image below shows the equivalent circuit as above but utilizes mechanical switches that are in the same package. Notice the default is shown by black boxes located closer to the ON label of the switches. In order to disconnect these switches, physically move the switch to the OFF position.

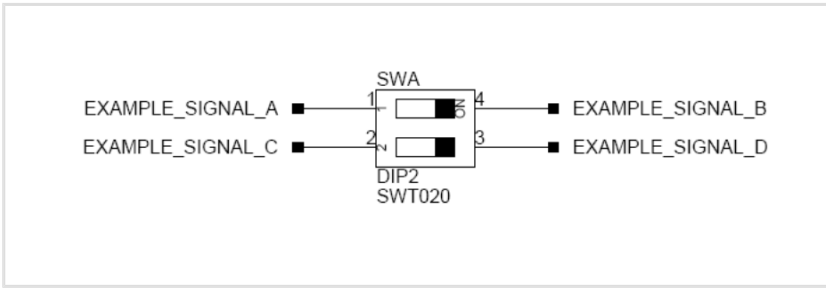

The circuit below shows a bus switch example, reference designator UC (Pericom PI3LVD512ZHE), selecting between lettered functionality and numbered functionality. The signals on the left side are multiplexed signals with naming convention letter\_number. The right side of the circuit shows the signals separated into letter and number, with the number on the lower group (eg. 0B1) and the letter on the upper group (eg. 0B2). The default setting is controlled by the signal CONTROL\_LETTER\_NUMBER which is pulled low. This selects the number signals on the right to be connected to the multiplexed signals on the left by default. In this example, the Microchip IO expander is not shown but controls the signal CONTROL\_LETTER\_NUMBER and allows the user to change the selection through software.

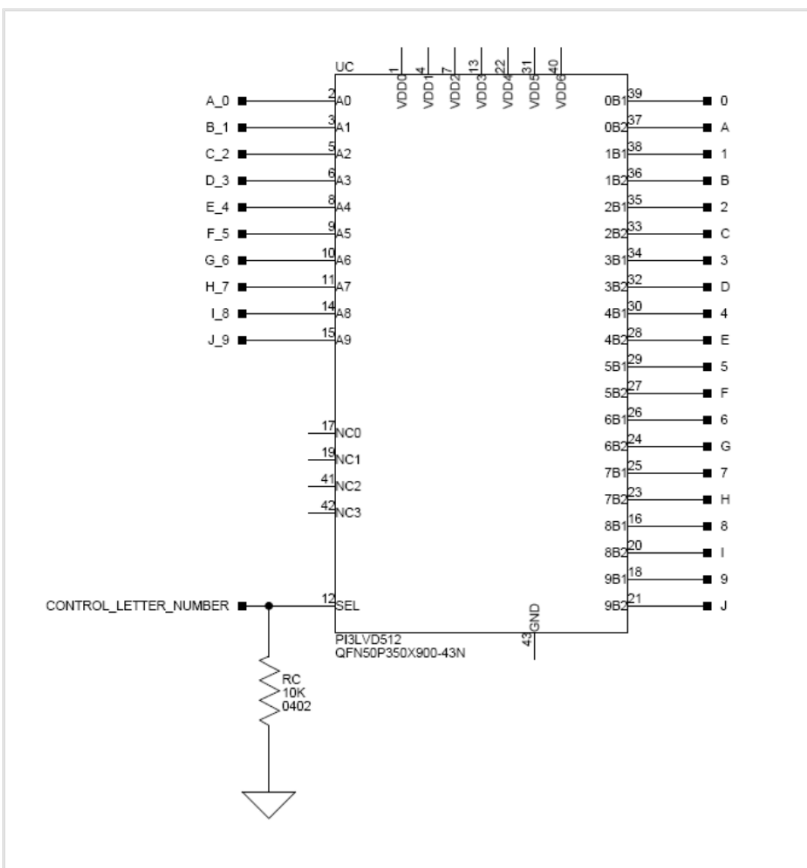

The image below shows the equivalent circuit as above but utilizes mechanical switches. Notice the default for reference designators SWC and SWD is illustrated by black boxes located closer to the ON label of the switches to enable the number signals by default. Also notice the default setting for

reference designators SWE and SWF is OFF. In order to connect the letters instead of the numbers, the user physically changes all switches on SWC and SWD to the OFF position and all switches on SWE and SEF to the ON position.

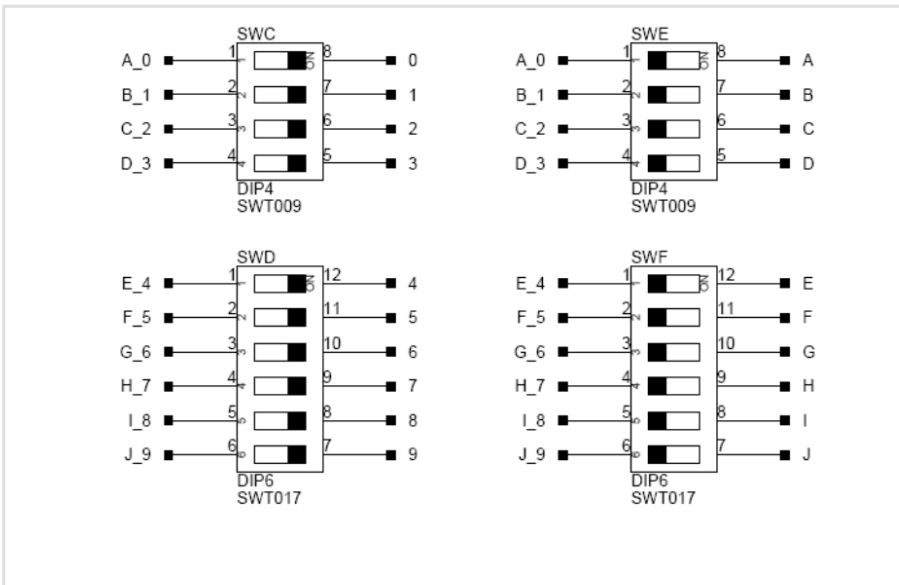

### 3.2.2 SoftConfig on the ADSP-SC584 EZ-Board

Two Microchip MCP23017 GPIO expanders provide control for individual electronic switches. The TWI0 interface of the processor communicates with the Microchip devices.

Note that only interfaces affected by software switches are listed.

Default ADSP-SC584 Processor Interface Availability	
Interface	Availability by Default
UART0	USB to UART FTDI232RQ
EMAC0	RGMII interface enabled
EMAC0	RMII interface enabled
SPI Flash	Quad mode enabled
Audio Connectors	4 inputs/8 outputs
SD Card	Write protect enabled
S/PDIF Digital	S/PDIF RCA input and output connectors enabled



Push buttons	Enabled
LEDs	Enabled

### 3.2.3 Programming SoftConfig Switches

On the ADSP-SC584 EZ-Board, two Microchip MCP23017 devices exist. Each of these devices have the following programming characteristics:

Each switch has two programmable GPIO registers.

GPIO Register	Register Address
GPIOA	0x12
GPIOB	0x13

Each GPIO register controls eight signals (software switches).

- By default, the Microchip MCP23017 GPIO signals function as input signals.
- The signals must be programmed as output signals to override their default values.

The following table shows the Microchip register addresses and the values that must be written to them to program the signals as output signals.

IODIR Register	IODIR Register Address	Value to be Written to Program Signals as Outputs
IODIRA	0x00	0
IODIRB	0x01	0

Each of the examples in the ADSP-SC584 Board Support Package include source files that program the soft switches, even if the default settings are being used. The README for each example identifies only the signals that are being changed from their default values. The code that programs the soft switches is located in the `SoftConfig_SC584.c` file in each example.

The following tables outline the default values for each of the two Microchip MCP23017 devices.

GPIO	MCP23017 Register Address	Default Value
GPIOA	0x12	0xE0

<b>GPIO</b>	<b>MCP23017 Register Address</b>	<b>Default Value</b>
GPIOB	0x13	0x00

<b>GPIO</b>	<b>MCP23017 Register Address</b>	<b>Default Value</b>
GPIOA	0x12	0xB9
GPIOB	0x13	0x3F

The ADSP-SC584 EZ-Board Schematic shows how the two Microchip GPIO expanders are connected to the board's ICs.

The tables below show the output signals of the Microchip GPIO expander (U47), with a TWI address of 0100 001X, where X represents the read or write bit. The signals that control an individual FET have an entry under the **FET** column. The **Component Connected** column shows the board IC that is connected if the FET is enabled. The Microchip (U47) is controlling the enable signal of a FET switch. Also note that if a particular functionality of the processor signal is being used, it will be in **bold font** under the **Processor Signal** column.

#### Output Signals of Microchip GPIO Expander (U47 Port A)

<b>Bit</b>	<b>Signal Name</b>	<b>Description</b>	<b>FET</b>	<b>Processor Signal (if applicable)</b>	<b>Component Connected</b>	<b>Default</b>
<b>0</b>	EEPROM_EN	SPI EEPROM CS	U24	PD_01/ <b>SPI0_SEL2</b> /ACM0_A4/SMC0_AOE /SPI0_SS	U4	High
<b>1</b>	UART0_FLOW_EN	UART0 Flow Control	U27	PC_15/ <b>UART0_RTS</b> /PPI0_FS3/ACM0_A2 /SMC0_AMS0, PD_00/ <b>UART0_CTS</b> /PPI0_D23 /ACM0_A3/SMC0_D07	U26	High
<b>2</b>	UART0_EN	Enables UART0	U27	PC_13/ <b>UART0_TX</b> /SPI1_SEL1/ACM0_A0, PC_14/ <b>UART0_RX</b> /ACM0_A1/TM0_ACIO	U26	Low
<b>3</b>	ETH0_EN	Enables Ethernet 0	U65, U63	EMAC0 signals	U49	High
<b>4</b>	ETH1_EN		U29, U43	EMAC0 signals	U67	High

Bit	Signal Name	Description	FET	Processor Signal (if applicable)	Component Connected	Default
		Enables Ethernet 0				
5	MLB3_EN	Enables MLB3		None	J13	High
6	CAN0_EN	Enables CAN0	U5	CAN0 signals	U39	High
7	CAN1_EN	Enables CAN1	U5	CAN1 signals	U58	High

#### Output Signals of Microchip GPIO Expander (U47 Port B)

Bit	Signal Name	Description	FET	Processor Signal (if applicable)	Component Connected	Default
0	ADAU1962_EN	Enables ADAU1962	U6	<b>DAI1_PIN02, DAI1_PIN04, DAI1_PIN01, DAI1_PIN05</b>	U38	High
1	ADAU1979_EN	Enables ADAU1979	U6	<b>DAI1_PIN12, DAI1_PIN20, DAI1_PIN06, DAI1_PIN07</b>	U41	High
2	AUDIO_JACK_SEL	Selects between connector being configured for input or output	U40	None	J3	High
3	<i>NOT USED</i>					
4	SPI2FLASH_CS_EN	SPI2 FLASH CS	U44	<b>PC_06/SPI2_SEL1 /SPI2_SS</b>	U3	Low
5	SPI2D2_D3_EN	Enables Quad mode for SPI2 Flash	U45, U60	<b>PC_04/SPI2_D2</b>	U3	Low
6	SPDIF_OPTICAL_EN				J1, J10	High

Bit	Signal Name	Description	FET	Processor Signal (if applicable)	Component Connected	Default
		Enables S/PDIF optical connectors	U15, U18	<b>DAI0_PIN19, DAI0_PIN20</b>		
7	SPDIF_DIGITAL_EN	Enables S/PDIF digital connectors	U16, U17	<b>DAI0_PIN19, DAI0_PIN20</b>	U50, U53	Low

**Table 2-6** and **Table 2-7** shows the output signals of the Microchip GPIO expander (U48), with a TWI address of 0100 010X, where X represents the read or write bit. The signals that control an individual FET have an entry under the **FET** column. The **Component Connected** column shows the board IC that is connected if the FET is enabled. Note that some of the Microchip (U48) output signals are connected directly to components on the board. However, in most cases, the Microchip (U48) is controlling the enable signal of a FET switch. Also note that if a particular functionality of the processor signal is being used, it will be in **bold font** under the **Processor Signal** column.

**Table 2-6 - Output Signals of Microchip GPIO Expander (U48 Port A)**

Bit	Signal Name	Description	FET	Processor Signal (if applicable)	Component Connected	Default
0	PUSHBUTTON3_EN	PC_15 is used as GPIO input for push button 3, enabled by default	U19	<b>PC_15</b> /UART0_RTsb /PPIO_FS3/ACM0_A2 /SMC0_AMS0	U59	Low
1	PUSHBUTTON2_EN	PB_00 is used as GPIO input for push button 2, enabled by default	U23	<b>PB_00</b> /ETH0_PTTPPS1 /SINC0_D2/PPIO_D14 /SMC0_A08/TM0_ACLK3	U59	Low
2	PUSHBUTTON1_EN	PA_15 is used as GPIO input for push button 1, enabled by default	U22	<b>PA_15</b> /ETH0_PTTPPS2 /SINC0_D1/SMC0_A09	U59	Low
3	LEDS_EN	PE_01-PE_08 is used as GPIO output for LED10-17, enabled by default	U8	<b>PE_01-PE_08</b>	LED10-17	Low
4	FLG0_LOOP	Connects 2 LEDs together, disabled by default	U21	NA	LED10-11	High

Bit	Signal Name	Description	FET	Processor Signal (if applicable)	Component Connected	Default
5	FLG1_LOOP	Connects 2 LEDs together, disabled by default	U61	NA	LED12-13	High
6	FLG2_LOOP	Connects 2 LEDs together, disabled by default	U62	NA	LED14-15	High
7	FLG3_LOOP	Connects 2 LEDs together, disabled by default	U64	NA	LED16-17	High

**Table 2-7 - Output Signals of Microchip GPIO Expander (U48 Port B)**

Bit	Signal Name	Description	FET	Processor Signal (if applicable)	Component Connected	Default
0	ADAU1977_EN	Enables ADAU1977	U7	<b>DAI1_PIN08, DAI1_PIN09, DAI1_PIN10, DAI1_PIN11</b>	U42	High
1	ADAU1977_FAULT_RST_EN	Enables ADAU1977 FAULT and RESET	U7	<b>PA_15/ETH0_PTTPPS2/SINC0_D1 /SMC0_A09, PB_00 /ETH0_PTTPPS1/SINC0_D2 /PPI0_D14/SMC0_A08 /TM0_ACLK3</b>	U42	High
2	THUMBWHEEL_OE	Enables thumbwheel switch	U28	<b>PB_12/LP1_D5/PWM0_DL /SMC0_D10/CNT0_UD, PB_14 /LP1_D7/TM0_TMR5/PWM0_CL /SMC0_D08/CNT0_DG, PB_11 /LP1_D4/PWM0_DH/SMC0_D11/ CNT0_ZM</b>	SW5	High
3	ENGINE_RPM_OE	PE_09 is used as an input for engine RPM, disabled by default	U52	<b>PE_09/PPI0_D03/PWM0_SYNC /TM0_TMR0/SMC0_D03</b>	P12	High
4	AD2410_MASTER_SLAVE		NA	NA	U10	Low

Bit	Signal Name	Description	FET	Processor Signal (if applicable)	Component Connected	Default
		Selects between master (low) and slave (high)				

### 3.3 Push Buttons and Switches

This section describes operation of the push buttons and switches.

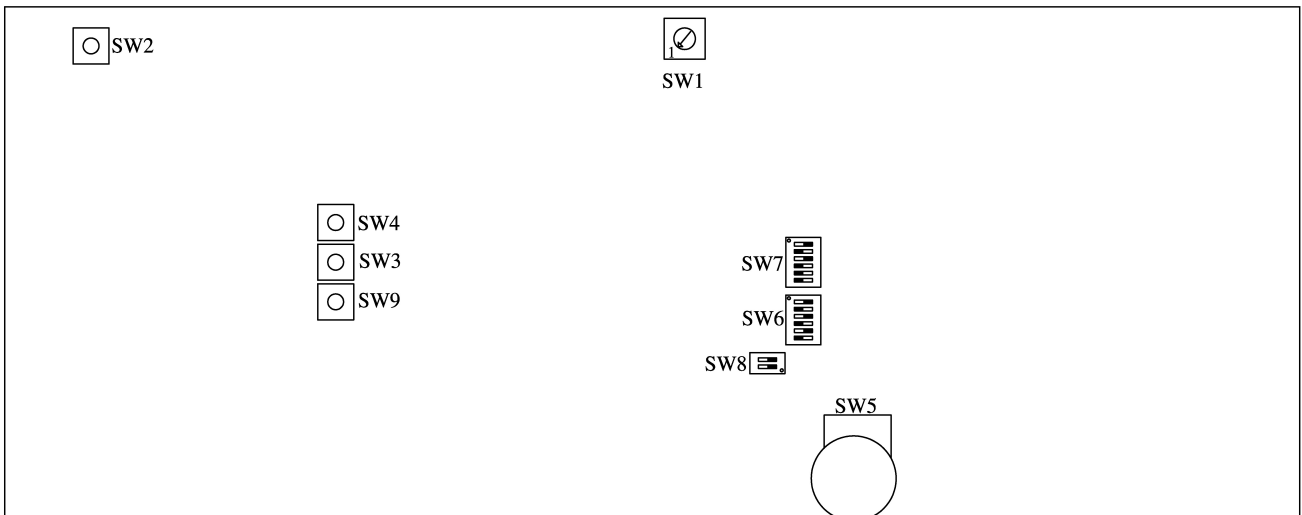

#### 3.3.1 Boot Mode Select Switch (SW1)

The rotary switch (SW1) determines the boot mode of the processor. By default, the ADSP-SC584 processor boots from the SPI flash memory.

SW1 Position	Processor Boot Mode
0	No boot
1	<b>SPI2 master boot. Default boot mode.</b>
2	SPI2 slave boot
6	LP0 slave boot

SW1 Position	Processor Boot Mode
7	UART0 slave boot

### 3.3.2 Reset Push Button (SW2)

The reset push button (SW2) resets the following ICs: processor (U1), GPIO extender (U47), GPIO extender (U48), and Ethernet PHYs (U49 and U57). Also, the reset push button is connected to the expansion interface through the SYS\_HWRST signal.

### 3.3.3 GPIO Push Buttons (SW3-4 and SW9)

The GPIO push buttons (SW3, SW4 and SW9) are connected to the processor's signals PB\_00/ETH0\_PTPPPS1/SINC0\_D2/PPI0\_D14/SMC0\_A08/TM0\_ACLK3, PA\_15/ETH0\_PTPPPS2/SINC0\_D1/SMC0\_A09 and PC\_15/UART0\_RTSb/PPI0\_FS3/ACM0\_A2/SMC0\_AMS0b, respectively. The signals are connected by default.

### 3.3.4 Rotary Encoder With Momentary Switch (SW5)

The rotary encoder (SW5) can be turned clockwise for an up count or counter-clockwise for a down count. The encoder also features a momentary switch, activated by pushing the switch towards the center of the board, that can be used to set the counter to zero. The rotary encoder is a two-bit quadrature (Gray code) encoder.

The rotary encoder can be disconnected from the processor by setting SoftConfig, see [Software-Controlled Switches \(SoftConfig\)](#) for more information.

### 3.3.5 JTAG Interface Switches (SW6-7)

The JTAG switches (SW6-7) select between a single processor (one board) and multiprocessor (more than one board) configurations. By default, the switches are set up for a single EZ-Board configuration.

Single Processor Configuration	
Switch Position	Single EZ-Board Use (Default)
SW6.1	ON
SW6.2	OFF
SW6.3	ON

<b>Single Processor Configuration</b>	
SW6.4	OFF
SW6.5	ON
SW6.6	OFF
SW7.1	ON
SW7.2	OFF
SW7.3	ON
SW7.4	OFF
SW7.5	OFF
SW7.6	OFF

To use an emulator and multiple EZ-Boards simultaneously in one CrossCore Embedded Studio (CCES) multiprocessor session, set up the boards as shown below. Attach the boards to each other through connectors J8 and J9. Connect using the Samtec cables described in [Link Port/JTAG Connectors \(J8-J9\)](#).

<b>Multiprocessor Configuration</b>		
<b>Switch Position</b>	<b>Main EZ-Board Attached to Emulator</b>	<b>EZ-Board Not Attached to Emulator</b>
SW6.1	ON	OFF
SW6.2	ON	ON
SW6.3	ON	OFF
SW6.4	ON	ON
SW6.5	ON	OFF
SW6.6	ON	ON



Multiprocessor Configuration		
SW7.1	ON	OFF
SW7.2	ON	OFF
SW7.3	ON	OFF
SW7.4	OFF	ON
SW7.5	OFF	ON
SW7.6	ON	OFF

### 3.3.6 CAN Wake Switch (SW8)

The CAN Wake switch (SW8) enables or disables the wake option on each of the CAN transceivers.

## 3.4 Jumpers

This section describes functionality of the configuration jumpers.

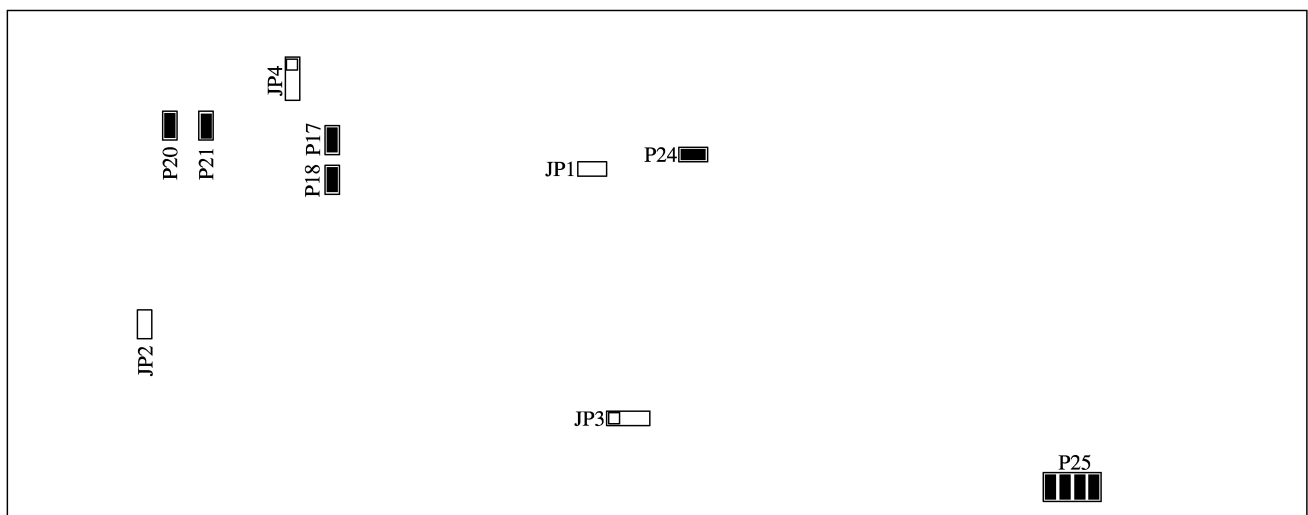

### 3.4.1 Isolated Transformer Jumper (JP1)

The Isolated Transformer jumper (JP1) should be installed when the board is powered from a galvanic isolated transformer power supply. The default is installed.

### 3.4.2 S/PDIF Loopback Jumper (JP2)

The S/PDIF loopback jumper (JP2) is used to connect the S/PDIF input and output signals together and bypass the two RCA connectors.

### 3.4.3 CAN INH Jumper (JP3)

The CAN INH jumper (JP3) is used to connect the inhibit output signal from the CAN transceiver to drive the enable/disable signal to the voltage regulator that powers the boards.

Installed Jumper	Driver
1 & 2	TJA1055
2 & 3	TJA1145

### 3.4.4 Regulator Jumper (JP4)

The Regulator jumper (JP4) is used to allow either the CAN transceiver or the A2B interface to drive the enable/disable signal to the voltage regulator that powers the boards.

Installed Jumper	Driver
1 & 2	CAN
2 & 3	A2B

### 3.4.5 HADC Jumpers (P25)

The HADC jumper (P25) is used to connect the HADC of the ADSP-SC584 processor to various voltages on the board for monitoring.

Installed Jumper	Voltage
1 & 2	3.3V
3 & 4	1.8V
5 & 6	VDD_INT
7 & 8	12V

### 3.4.6 Power Jumpers (P17-18, P20-21, P24)

Remove jumpers listed below to measure the respective voltage across the sense resistor.

Power Jumper	Resistor
P17	VDD_INT
P18	1.8V
P20	3.3V
P21	VDD_EXT
P24	USB0_VBUS

### 3.5 LEDs

This section describes the on-board LEDs.

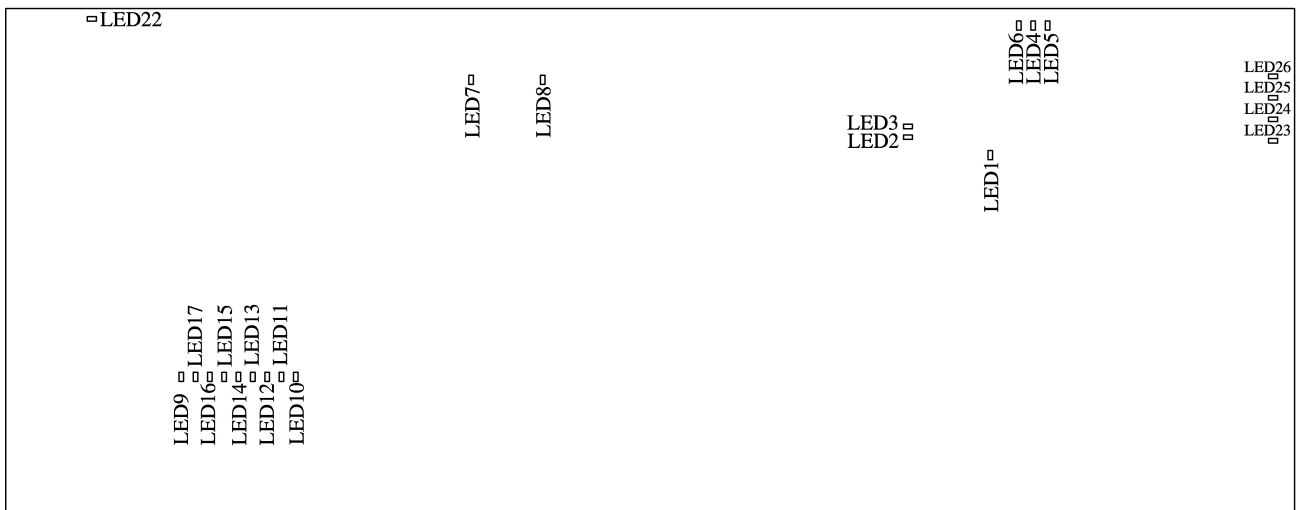

#### 3.5.1 SYS\_FAULT LED (LED1)

When SYS\_FAULT LED LED1 (red) is ON, it indicates a system fault. For more information, refer to the ADSP-SC58x SHARC+ Processor Hardware Reference.

### 3.5.2 USB to UART Activity LEDs (LED2-3)

When LED2 is toggling (amber), it indicates that data is being sent from the PC to the EZ-Board. When LED3 is toggling (amber), it indicates that data is being sent from the EZ-Board to the PC.

### 3.5.3 Ethernet Link LED (LED4-5)

The Ethernet link LED (LED4-5) reports on the status of the BCM89810 link signal rate. LED5 is yellow when there is a 100M link. LED4 is green when there is a 10M link.

### 3.5.4 Ethernet Activity LED (LED6)

The Ethernet activity LED (LED6) reports on the transmit/receive of the BCM89810. LED6 is green when there is activity.

### 3.5.5 A2B Interrupt LEDs (LED7-8)

Two LEDs are connected to the interrupt pin of each of the AD2410 A<sup>2</sup>B transceivers. When the device is a master the interrupt is an output to the SC584 and when it is a slave it is an input from the SC584.

### 3.5.6 Power LED (LED9)

When LED9 is ON (green), power is properly supplied to the board.

### 3.5.7 GPIO LEDs (LED10-17)

Three LEDs are connected to general-purpose I/O pins of the processor. The LEDs are active high and are ON (amber) by writing a 1 to the correct processor signal.

LED Reference Designator	Processor Programmable Flag Pin
LED10	PE_01
LED11	PE_02
LED12	PE_03
LED13	PE_04
LED14	PE_05

LED Reference Designator	Processor Programmable Flag Pin
LED15	PE_06
LED16	PE_07
LED17	PE_08

### 3.5.8 Reset LED (LED22)

When LED22 is ON (red), master reset is active. The reset LED is controlled by the Analog Devices ADM6315 supervisory reset circuit. A master reset is asserted by pressing SW2 which activates LED22. For more information, see [Reset Push Button \(SW2\)](#).

### 3.5.9 Ethernet LEDs (LED23-26)

Four LEDs are connected to LED pins of the DP83865 connected on EMAC0. The LEDs are green when on.

LED Reference Designator	Status
LED23	Activity
LED24	10M link
LED25	100M link
LED26	1000M link

## 3.6 Connectors

This section describes connector functionality and provides information about mating connectors.

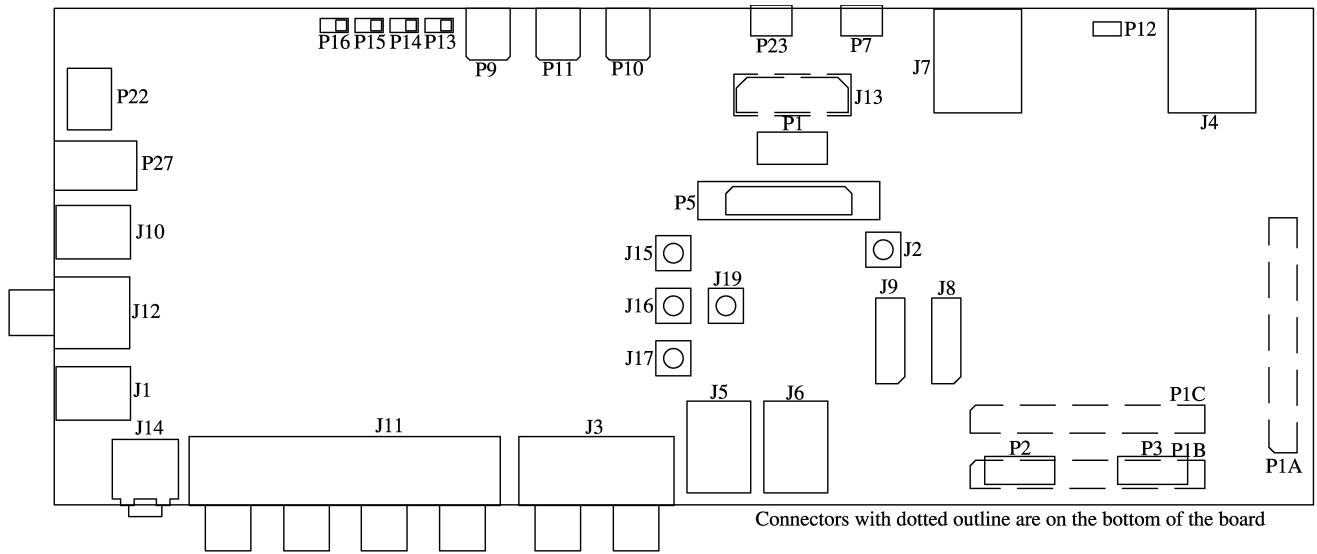

### 3.6.1 S/PDIF Optical Tx Connector (J1)

Part Description	Manufacturer	Part Number
Fiber optic transmitter	Everlight	PLT133/T10W
<b>Mating Cable</b>		
Standard TOSLINK Optical Digital Cable		

### 3.6.2 CLKIN0 Connector (J2)

Part Description	Manufacturer	Part Number
SMB jack	Emerson	131-3711-201
<b>Mating Cable</b>		
Standard SMB cable		

### 3.6.3 Audio Input\_Output Connector (J3)

Part Description	Manufacturer	Part Number
RCA 2x2 female	Switchcraft	PJRS2X2S

Part Description	Manufacturer	Part Number
<b>Mating Connector</b>		
Standard audio cable with RCA connectors		

### 3.6.4 Ethernet Connector (J4, J7)

Part Description	Manufacturer	Part Number
RJ45	ASSMANN	A-2004-2-4-LPS-N-R
<b>Mating Cable</b>		
Standard Ethernet cable		

### 3.6.5 CAN Connectors (J5-J6)

Part Description	Manufacturer	Part Number
RJ11 vertical	TE Connectivity	5558872-1
<b>Mating Connector</b>		
RJ11 cable		

### 3.6.6 Link Port/JTAG Connectors (J8-J9)

The link port/JTAG connectors provide access to the link port and JTAG signals of the ADSP-SC584 processor. J8 supports link port 0 and the J9 connector supports link port 1.

Part Description	Manufacturer	Part Number
ERF8 10X2, female	SAMTEC	ERF8-010-05.0-D-DV-L
<b>Mating Cable</b>		
6" coax cable assembly	SAMTEC	ERCD-010-06.00-TED-TEU-1-D

### 3.6.7 S\_PDIF Optical Rx Connector (J10)

Part Description	Manufacturer	Part Number
Fiber optic receiver	Everlight	PLR135/T10
<b>Mating Cable</b>		
Standard TOSLINK Optical Digital Cable		

### 3.6.8 Audio Output Connector (J11)

Part Description	Manufacturer	Part Number
RCA 4x2 female	Switchcraft	PJRS4X2U
<b>Mating Connector</b>		
Standard audio cable with RCA connectors		

### 3.6.9 S/PDIF Digital Connector (J12)

Part Description	Manufacturer	Part Number
RCA 1x2 female	Switchcraft	PJRS1X2S02X
<b>Mating Cable</b>		
Standard S/PDIF cable with RCA connectors		

### 3.6.10 MLB Connector (J13)

Part Description	Manufacturer	Part Number
40-pin high speed socket	SAMTEC	QSH-020-01-L-D-DP-A
<b>Mating Connector</b>		
40-pin high speed header	SAMTEC	QTH-0202-01-L-D-DP-A



### 3.6.11 Headphone Connector (J14)

Part Description	Manufacturer	Part Number
3.5mm headphone connector	CUI	SJ1-3525NG
<b>Mating Cable</b>		
Standard audio cable with 3.5mm connector		

### 3.6.12 HADC Input Connectors (J15-J17, J19)

Part Description	Manufacturer	Part Number
SMB jack	Emerson	131-3711-201
<b>Mating Connector</b>		
Standard SMB cable		

### 3.6.13 JTAG Connector (P1)

The JTAG header (P1) provides debug connectivity for the processor. This is a 0.05" shrouded through-hole connector from SAMTEC (SHF-105-01-L-D-SM-K). This connector mates with ICE-1000, ICE-2000, and any newer Analog Devices emulators. For more information, see [Debug Interface](#).

### 3.6.14 SigmaStudio Connector (P2)

This connector interfaces with SigmaStudio through the EVAL-ADUSB2EBZ board. The connector is a 0.1" header. The pinout can be found in the [Appendix B - Schematic](#).

### 3.6.15 TWI0\_SPI2 Connector (P3)

Use P3 to connect with TWI0 and SPI2 signals for external use. The connector is a 0.1" header. The pinout can be found in the ADSP-SC584 EZ-Board Schematic.

### 3.6.16 TRACE and JTAG Connector (P5)

The TRACE and JTAG connector (P5) provides connectivity to the processor's trace interface. This is a MICTOR connector from TYCO (2-5767004-2). At this time, there are no trace pods available.

### 3.6.17 USB to UART Connector (P7)

Part Description	Manufacturer	Part Number
USB Micro-AB	Hirose	ZX62D-AB-5P8
<b>Mating Cable</b>		
USB Micro-B to Standard-A cable		

### 3.6.18 A2B Connectors (P9-P11)

Part Description	Manufacturer	Part Number
2-pin DuraClik	Molex	5023520200
<b>Mating Cable</b>		
DuraClik cable assembly		

### 3.6.19 Engine RPM Connectors (P12)

Part Description	Manufacturer	Part Number
IDC 2x1 0.1"	Samtec	HTSW-102-07-T-S
<b>Mating Cable</b>		
Custom cable assembly		

### 3.6.20 Microphone Connectors (P13-P16)

Part Description	Manufacturer	Part Number
IDC 2x1 0.1"	Samtec	HTSW-102-07-T-S
<b>Mating Cable</b>		
Custom cable assembly		

### 3.6.21 Power Connector (P22)

Part Description	Manufacturer	Part Number
2.1 mm power jack	CUI	PJ-102AH
<b>Mating Cable</b>		
12.0VDC@1.5A power supply	CUI	EMSA120150-P5RP-SZ

### 3.6.22 USB Connectors (P23)

Part Description	Manufacturer	Part Number
USB Micro-AB	Hirose	ZX62D-AB-5P8
<b>Mating Cable</b>		
USB Micro-B to Standard-A or Micro-A to Standard-A receptacle cable		

### 3.6.23 Power Connector (P27)

Part Description	Manufacturer	Part Number
5.08mm power jack	WEIDMULLER	1760510000
<b>Mating Cable</b>		
12.0VDC discrete wires		

### 3.6.24 Expansion Interface III Connectors (P1A-C)

Three board-to-board connectors provide signals from the SPI, TWI, UART, SPORT, and GPIO interfaces of the processor. The connectors are located on the bottom side of the board.

For more information, see Expansion Interface.

Part Description	Manufacturer	Part Number
120-pin, 0.6 mm	Hirose	FX8-120P-SV1(91)

<b>Part Description</b>	<b>Manufacturer</b>	<b>Part Number</b>
<b>Mating Connector</b>		
120-pin, 0.6 mm	Hirose	FX8-120S-SV(21)

## 4 Appendix A - Bill Of Materials

[Edit Document](#)

Qty	Description	Reference Designator	Manufacturer	Part Number
1	74LVC14A SOIC14	U59	DIGI-KEY (R)	296-1699-2-ND
1	IDT74FCT3244APY SSOP20	U8	IDT (R)	IDT74FCT3244APYG
1	SN74LVC1G125 SOT23-5	U52	TI (R)	74LVC1G125DBVRE4
3	SN74LVC1G08 SOT23- 5	U53-U55	TI (R)	SN74LVC1G08DBVE
1	SN65LVDS2D SOIC8	U50	NATIONAL S (R)	DS90LV018ATM
4	SN74CB3Q3245 TSSOP20	U29,U43,U63,U65	DIGI-KEY (R)	296-19130-1-ND
1	MIC2025-1 SOIC8	U69	DIGI-KEY (R)	576-1057-ND
3	74CBTLV3244 TSSOP20	U5-U7	IDT (R)	IDT74CBTLV3244PGG
2	25MHZ OSC013	Y1,Y2	DIGI-KEY (R)	535-9140-1-ND
1	24MHZ OSC013	Y3	DIGI-KEY (R)	535-9138-2-ND
19	74CBTLV1G125 SC70_5	U11-U19,U21-U24,U44,U45,U60- U62,U64	TI (R)	SN74CBTLV1G125DCKR
2	MCP23017 QFN65P600X600-29N	U47,U48	DIGI-KEY (R)	MCP23017-E/ML-ND

2	PI3C3125 TSSOP14	U27,U28	PERICOM (R)	PI3C3125
2	25MHZ OSCCC200X250	U31,U68	DIGI-KEY (R)	478-4780-1-ND
1	VOM618A-3T SOP254P440X385X202- 4N	U20	VISHAY (R)	VOM618A-3T
4	BSS308PE SOT23	Q1-Q4	INFINEON (R)	BSS308PE H6327
1	FT232RQ QFN50P500X500- 33NA	U26	DIGI-KEY (R)	768-1008-1-ND
1	INA3221 QFN65P400X400-17N	U57	DIGI-KEY (R)	296-30459-1-ND
1	24MHZ OSCCC200X250	U30	DIGI-KEY (R)	478-4778-1-ND
1	MT47H128M16 FBGA84	U2	MICRON (R)	MT47H128M16RT-25E XIT:C
1	ADM8828ARTZ SOT95P280-6N	U72	ADI (R)	ADM8828ARTZ
1	FZT953 SOT-223	VR2	DIGI-KEY (R)	FZT953CT-ND
1	TJA1145T SOIC14	U58	NXP (PHILI (R)	TJA1145T
1	TJA1055/3 SOIC14	U39	NXP (PHILI (R)	TJA1055/3
1	DP83865 PQFP128	U49	TI (R)	DP83865DVH/NOPB
1	H5007 SMT	U32	DIGI-KEY (R)	553-1535-1-ND
1	SI4204 SOIC8	U56	VISHAY (R)	SI4204DY-T1-GE3

1	ADP5054 LFCSP48	VR3	ADI (R)	ADP5054ACPZ-R7
1	CS2100-CP MSOP10	U51	DIGI-KEY (R)	598-1750-ND
1	SI5356A QFN24	U25	SILICON LA (R)	Si5356A-B03215-GM
2	25MHZ SMT	Y4,Y6	ECS INC. (R)	ECS-250-20-3X-TR
1	SC584 W25Q128FV U3	U3	WINBOND (R)	W25Q128FVSIG
1	SC584 25LC010A U4	U4	MICROCHIP (R)	25LC010AT-I/OT
1	BCM89810 MLP48	U67	BROADCOM	BCM89810A2AMLG
1	TPS54340 HSOIC8	VR6	DIGI-KEY (R)	296-35072-2-ND
1	AD8532ARZ SOIC8	U33	ADI (R)	AD8532ARZ
4	AD8606ARZ SOIC8	U34-U37	ADI (R)	AD8606ARZ
1	ADG774ABRQZ QSOP16	U40	ADI (R)	ADG774ABRQZ
1	AD8022 MSOP8	U66	ADI (R)	AD8022ARMZ
1	ADP121-AUJZ25 TSOT5	VR1	ADI (R)	ADP121-AUJZ25R7
1	ADP170AUJZ-1.2 TSOT5	VR4	ADI (R)	ADP170AUJZ-1.2-R7
1	ADAU1977 LFCSP40	U42	ADI (R)	ADAU1977WBCPZ
2	AD2410WACSZ LFCSP32	U9,U10	ADI (R)	AD2410WCCSZ
1	ADM6315 SOT143	U46	ADI (R)	ADM6315-29D2ARTZR7

1	ADAU1979WBCPZ LFCSP40	U41	ADI (R)	ADAU1979WBCPZ
2	ADP7104ACPZ LFCSP8	U70,U71	ADI (R)	ADP7104ACPZ-R7
1	ADSPSC584 CSPBGA349	U1	ADI	ADSP-SC584-ENG
1	RCA 4X2 CON011	J11	SWITCHCRAF (R)	PJRS4X2U01X
1	RCA 2X2 CON013	J3	SWITCHCRAF (R)	PJRS2X2S01X
1	MICTOR 38PIN CON015	P5	TYCO ELECT (R)	2-5767004-2
2	DIP6 SWT017	SW6,SW7	CTS (R)	218-6LPST
1	RCA 1X2 CON031	J12	SWITCHCRAF (R)	PJRS1X2S02X
1	IDC 4X2 IDC4X2_M_SMT	P25	SAMTEC (R)	TSM-104-01-T-DV
2	RJ11 4PIN CON039	J5,J6	TYCO ELECT (R)	5558872-1
1	DIP2 SWT020	SW8	DIGI-KEY (R)	CKN9064-ND
10	IDC 2X1 IDC2X1	P12-P18,P20,P21,P24	SAMTEC (R)	HTSW-102-07-T-S
1	3A RESETABLE FUS004	F1	TYCO ELECT (R)	SMD300F-2
1		J14	DIGI-KEY (R)	CP1-3525NG-ND



	3.5MM STEREO_JACK CON_CUI_SJ1- 3525NG			
2	IDC 2X1 IDC2X1_SMT	JP1,JP2	SAMTEC (R)	TSM-102-01-T-SV
2	IDC 3X1 IDC3X1_SMT	JP3,JP4	SAMTEC (R)	TSM-103-01-T-SV
1	ROTARY SWT027	SW1	COPAL ELEC (R)	S-8110
3	0.6MM 120PIN HIROSE_FX8-120P- SV1(91)	P1A,P1B,P1C	HIROSE (R)	FX8-120P-SV1(91)
1	TEST LOOP LOOP_2838	GP1	KEYSTONE (R)	5016
2	IDC 5X2 TSM-105-01- T-DV	P2,P3	SAMTEC (R)	TSM-105-01-T-DV
2	USB-MICRO 5PIN HIROSE_ZX62D-AB- 5P8	P7,P23	DIGI-KEY (R)	H11494CT-ND
1	PWR 2.1MM_JACK CUI-INC_PJ-102AH	P27	DIGIKEY	CP-102AH-ND
1	FIBER-OPTIC SPDIF EVERLIGHT_PLT133 /T10	J1	DIGI-KEY (R)	1080-1430-ND
1	FIBER-OPTIC SPDIF EVERLIGHT_PLR135 /T10	J10	DIGI-KEY (R)	1080-1433-ND

3	DURACLIK 2PIN MOLEX_502352-0200	P9-P11	MOLEX (R)	5023520200
1	5.08MM 2POS WEIDMULLER_PM5. 08/2/90_3.5_SW	P22	WEIDMULLER (R)	1760510000
1	0.05 10PIN SAMTEC_SHF-105-01- L-D-TH	P1	SAMTEC (R)	SHF-105-01-L-D-TH-TR
5	SMB 1PIN SMT	J2,J15-J17,J19	EMERSON	131-3711-201
1	QSH 40PIN SMT	J13	SAMTEC (R)	QSH-020-01-L-D-DP-A
2	RJ45 8PIN TH	J4,J7	DIGI-KEY (R)	AE10387-ND
2	ERF8 10X2 SMT	J8,J9	SAMTEC (R)	ERF8-010-05.0-S-DV-L- TR
4	MOMENTARY SW_ADTSMW64	SW2-SW4,SW9	DIGI-KEY	679-2310-2-ND
1	ROTARY_ENCODER CUI_ACZ11BR4E- 15FD1-20C	SW5	DIGI-KEY	102-1769-ND
4	0.22UF 25V 10% 0805 X7R	C205,C206,C265,C389	AVX CORPOR (R)	08053C224KAT2A
4	600 200MA 0603	FER20-FER23	DIGI-KEY (R)	490-1014-2-ND
8	600 500MA 1206	FER3,FER4,FER13,FER24,FER25, FER32,FER34,FER35	LAIRD TECH	HZ1206B601R-10
4	1UF 16V 10% 0805 X7R	C395,C396,C415,C416	DIGI-KEY (R)	399-1284-2-ND
1		C391	KOA (R)	NPO0805HTTD681J

	680PF 50V 1% 0805 NP0			
12	10UF 16V 20% CAP002 ELEC	CT2-CT12,CT15	PANASONIC (R)	EEE1CA100SR
2	68UF 25V 20% CAP003	CT13,CT14	PANASONIC (R)	EEE-FC1E680P
1	0 1/8W 5% 0805	R386	VISHAY (R)	CRCW08050000Z0EA
1	190 5A FER002	FER29	MURATA (R)	DLW5BSN191SQ2
11	10UF 6.3V 10% 0805 X5R	C198,C212,C219,C226,C233,C323, C339,C355,C380-C382	AVX CORPOR (R)	08056D106KAT2A
4	4.7UF 6.3V 10% 0805 X5R	C142,C148,C168,C184	AVX CORPOR (R)	08056D475KAT2A
72	0.1UF 10V 10% 0402 X5R	C1,C2,C27,C68,C69,C86,C87,C89, C91-C94,C103,C105,C113,C115, C117,C122-C127,C129,C131,C132, C137,C139,C140,C207,C239-C242, C257,C277,C279,C280,C294,C302, C304,C306,C308,C310,C312,C314, C324-C328,C333,C337,C340-C344, C349,C353,C356-C360,C365,C370, C371,C376,C383,C4	AVX CORPOR (R)	0402ZD104KAT2A
1	0.1UF 10V 10% 0402 X5R	C21	AVX CORPOR (R)	0402ZD104KAT2A
113	0.01UF 16V 10% 0402 X7R	C3,C5-C18,C20,C23,C24,C31-C34, C41-C45,C83,C84,C97,C110,C118- C121,C141,C149,C169,C199-C204, C210,C243-C250,C253-C255,C278, C281-C290,C319-C322,C329-C332,	AVX CORPOR (R)	0402YC103KAT2A

		C334-C336,C338,C345-C348,C350-C352,C354,C361-C364,C366-C369,C372-C375,C377-C379,C385-C388,C392,C393,C401,		
26	10K 1/16W 5% 0402	R22,R73-R77,R205,R206,R293,R307,R308,R310,R312,R313,R315,R357,R379,R380,R391,R401,R417-R419,R422,R423,R431	VISHAY (R)	CRCW040210K0FKED
118	10K 1/16W 5% 0402	R6,R7,R19,R23,R33-R35,R37,R39,R41,R51-R57,R59,R66,R67,R69-R72,R78-R84,R113,R122-R127,R140-R145,R152,R153,R155,R164,R191,R192,R195,R196,R243-R250,R256,R259-R264,R266-R269,R273-R276,R278,R294-R296,R298,R302,R305,R306,R309,R311,R314,R316,R350-R355,R358,R360,	VISHAY (R)	CRCW040210K0FKED
5	4.7K 1/16W 5% 0402	R102-R104,R157,R416	DIGI-KEY (R)	541-4.7KJTR-ND
9	0 1/10W 5% 0402	R27-R32,R111,R194,R198	PANASONIC (R)	ERJ-2GE0R00X
22	0 1/10W 5% 0402	R24,R42-R46,R50,R112,R117-R120,R193,R197,R282,R285,R286,R304,R388,R396,R398,R430	PANASONIC (R)	ERJ-2GE0R00X
1	22 1/10W 5% 0402	R202	DIGI-KEY (R)	P22JTR-ND
18	33 1/16W 5% 0402	R36,R38,R40,R121,R265,R272,R277,R284,R335,R349,R356,R421,R449-R454	VISHAY (R)	CRCW040233R0JNED
1	150UF 10V 10% D TANT-LOW-ESR	CT16	DIGI-KEY (R)	478-3321-2-ND
1	107.0 1/10W 1% 0805	R204	DIGI-KEY (R)	311-107CRTR-ND

1	249.0 1/10W 1% 0805	R203	DIGI-KEY (R)	311-249CRTR-ND
20	1UF 16V 10% 0603 X5R	C54-C57,C59,C60,C62,C64-C67,C76- C79,C85,C256,C276,C408,C411	DIGI-KEY (R)	399-5090-2-ND
1	4.7UF 25V 20% 0805 X5R	C394	AVX CORPOR (R)	0805ZD475KAT2A
1	4.7UF 6.3V 20% 0603 X5R	C38	AVX CORPOR (R)	06036D475MAT2A
2	330 1/10W 5% 0603	R99,R100	DIGI-KEY (R)	541-330GTR-ND
2	1M 1/10W 5% 0603	R47,R387	VISHAY (R)	CRCW06031M00JNEA
1	130.0K 1/16W 1% 0603	R444	VISHAY (R)	CRCW0603130KFKEA
3	10.0K 1/16W 1% 0603	R201,R439,R443	VISHAY/DAL (R)	CRCW060310K0FKEA
2	1K 1/10W 5% 0603	R87,R88	DIGI-KEY (R)	311-1.0KGRTR-ND
8	237.0 1/10W 1% 0603	R211,R214,R219,R222,R227,R230, R235,R238	DIGI-KEY (R)	311-237HRTR-ND
4	750.0K 1/10W 1% 0603	R213,R221,R229,R237	DIGI-KEY (R)	311-750KHRTR-ND
4	11.0K 1/10W 1% 0603	R209,R217,R225,R233	DIGI-KEY (R)	311-11.0KHRTR-ND
8	5.49K 1/10W 1% 0603	R207,R212,R215,R220,R223,R228, R231,R236	DIGI-KEY (R)	311-5.49KHRTR-ND
2	49.9K 1/10W 1% 0603	R189,R190	DIGI-KEY (R)	311-49.9KHRTR-ND
8	5.76K 1/10W 1% 0603	R208,R210,R216,R218,R224,R226, R232,R234	DIGI-KEY (R)	311-5.76KHRTR-ND
8	100PF 50V 5% 0603 NPO	C213,C217,C220,C224,C227,C231, C234,C238	AVX CORPOR (R)	06035A101JAT2A

8	1000PF 50V 5% 0603 X7R	C215,C216,C222,C223,C229,C230, C236,C237	DIGI-KEY (R)	399-1083-2-ND
8	680PF 50V 5% 0603 NPO	C211,C214,C218,C221,C225,C228, C232,C235	MURATA (R)	GRM1885C1H681JA01D
5	75.0 1/10W 1% 0603	R200,R317-R320	VISHAY/DAL (R)	CRCW060375R0FKEA
9	1UF 6.3V 20% 0402 X5R	C183,C251,C252,C258,C259,C317, C318,C397,C398	MURATA (R)	GRM155R60J105ME19D
3	100 1/16W 5% 0402	R270,R271,R433	DIGI-KEY (R)	311-100JRTR-ND
2	390PF 25V 5% 0603 NPO	C96,C136	AVX CORPOR (R)	06033A391FAT2A
2	5600PF 16V 5% 0805 NPO	C95,C135	AVX CORPOR (R)	0805YA562JAT2A
1	15.0K 1/16W 1% 0603	R199	DIGI-KEY (R)	311-15.0KHRTR-ND
20	10UF 10V 10% 0805 X5R	C53,C58,C61,C88,C90,C102,C104, C106-C109,C114,C116,C128,C130, C133,C134,C414,C422,C424	MURATA (R)	GRM21BR61A106KE19L
2	61.9K 1/16W 1% 0603	R437,R441	PANASONIC (R)	ERJ-3EKF6192V
5	0.051 1/2W 1% 1206	R288,R289,R291,R292,R389	SEI (R)	CSF 1/2 0.05 1%R
1	10UF 16V 10% 1210 X5R	C419	AVX CORPOR (R)	1210YD106KAT2A
2	1000PF 50V 5% 1206	C418,C420	AVX CORPOR (R)	12065A102JAT2A
2	0.022UF 25V 10% 0402 X7R	C51,C52	DIGI-KEY (R)	490-3252-1-ND

2	5A MBRS540T3G SMC	D14,D16	ON SEMICON (R)	MBRS540T3G
1	VARISTOR V5.5MLA 30A 0603	R359	LITTELFUSE (R)	V5.5MLA0603
1	PTC 0.5A 1206	R400	LITTELFUSE (R)	1206L050-C
2	400MA ZHCS400 SOD- 323	D6,D9	DIGI-KEY (R)	ZHCS400CT-ND
13	330.0 1/16W 1% 0402	R5,R48,R49,R239-R242,R251-R255, R258	DIGI-KEY (R)	541-330LCT-ND
2	33.0K 1/16W 1% 0402	R148,R158	ROHM	MCR01MZPF3302
1	47.0K 1/16W 1% 0402	R68	ROHM	MCR01MZPF4702
2	3.01K 1/16W 1% 0402	R26,R435	Rohm Semiconduc	MCR01MRTF3011
12	1.0K 1/16W 1% 0402	R2,R3,R8,R9,R107,R115,R128,R146, R156,R257,R368,R447	PANASONIC (R)	ERJ-2RKF1001X
1	10.0 1/10W 1% 0603	R348	DIGI-KEY (R)	311-10.0HRTR-ND
2	10.0K 1/16W 1% 0402	R323,R397	DIGI-KEY (R)	541-10.0KLCT-ND
3	1.50K 1/16W 1% 0402	R25,R151,R163	PANASONIC (R)	ERJ-2RKF1501X
3	680 1/16W 1% 0402	R62,R63,R101	BC COMPONE (R)	2312 275 16801
1	100K 1/16W 5% 0402	R116	DIGI-KEY (R)	541-100KJTR-ND
11	100K 1/16W 5% 0402	R108-R110,R137-R139,R281,R369, R392,R436,R440	DIGI-KEY (R)	541-100KJTR-ND

1	15PF 50V 5% 0402 NPO	C407	DIGI-KEY (R)	399-1014-2-ND
1	1.0 1/16W 1% 0402	R455	DIGI-KEY (R)	541-1.00LCT-ND
1	22UF 16V 10% 1210 X5R	C48	TAIYO YUDE (R)	EMK325BJ226KM-T
1	1.24K 1/16W 1% 0603	R86	PANASONIC (R)	ERJ-3EKF1241V
6	18PF 50V 5% 0402 NPO	C22,C25,C26,C28-C30	Murata	GRM1555C1H180JA01D
7	33 1/32W 5% RNS005	RN1-RN5,RN7,RN8	PANASONIC (R)	EXB-28V330JX
2	0.01UF 25V 10% 0402 X7R	C36,C40	DIGI-KEY (R)	399-1278-1-ND
2	100.0 1/16W 1% 0402	R4,R10	DIGI-KEY (R)	541-100LCT-ND
1	1000PF 50V 5% 0402 NPO	C291	DIGI-KEY (R)	490-3244-1-ND
6	100PF 50V 5% 0402 COG	C74,C75,C80-C82,C384	MURATA	GCM1555C1H101JA16D
2	3300PF 50V 10% 0603 X7R	C158,C182	DIGI-KEY (R)	399-1086-2-ND
6	2.2K 1/10W 5% 0402	R13-R18	PANASONIC (R)	ERJ-2GEJ222X
7	GREEN LED_0603	LED4,LED6,LED9,LED23-LED26	DIGI-KEY (R)	475-1409-2-ND
2	4700PF 2A FIL_NFE61PT	FER30,FER33	DIGI-KEY (R)	490-2554-2-ND



7	10UF 16V 10% 0805 X5R	C4,C145,C161,C260,C262,C264,C266	DIGI-KEY (R)	490-3886-2-ND
2	60.4 1/10W 1% 0402	R64,R65	PANASONIC	ERJ-2RKF60R4X
10	499.0 1/10W 1% 0402	R96,R98,R129-R136	PANASONIC (R)	ERJ-2RKF4990X
28	49.9 1/16W 1% 0402	R336-R343,R362-R367,R371-R373, R375-R377,R384,R385,R406-R410, R414	STACKPOLE (R)	RMCF0402FT49R9
1	2.0K 1/10W 1% 0402	R325	PANASONIC (R)	ERJ-2RKF2001X
12	2.0K 1/10W 1% 0402	R321,R324,R326-R329,R331-R334, R446,R448	PANASONIC (R)	ERJ-2RKF2001X
5	0.1UF 16V 10% 0402 X7R	C35,C37,C39,C208,C209	DIGI-KEY (R)	587-1451-2-ND
2	15KV ESD7004 DFN50P250X100-10N	D5,D13	ON SEMICON (R)	ESD7004MUTAG
1	15KV ESDA6V1SC SOT95P280-6N	D4	DIGI-KEY (R)	497-6637-1-ND
2	60.4K 1/10W 1% 0603	R60,R61	DIGI-KEY (R)	311-60.4KHRTR-ND
3	22UF 6.3V 20% 0805 X5R	C63,C295,C316	DIGI-KEY	445-1422-2-ND
1	32.4K 1/10W 1% 0402	R297	PANASONIC (R)	ERJ-2RKF3242X
1	8.25K 1/16W 1% 0402	R382	DIGI-KEY (R)	541-8.25KLTR-ND
1	562.0 1/16W 1% 0402	R114	DIGI-KEY (R)	541-562LTR-ND

1	390PF 50V 5% 0402 NPO	C111	TDK (R)	C1005C0G1H391J
2	10PF 50V 5% 0402 NPO	C399,C400	DIGI-KEY (R)	399-1011-2-ND
3	10.2K 1/16W 1% 0402	R429,R438,R442	DIGI-KEY (R)	541-10.2KLTR-ND
1	10UF 50V 20% SMD	CT1	PANASONIC (R)	EEE-FC1H100P
1	4.7UH 30% SMD	L5	DIG01	732-1039-2-ND
2	RED LED_0603	LED1,LED22	DIGI-KEY (R)	475-2512-2-ND
13	YELLOW LED_0603	LED2,LED3,LED5,LED7,LED8, LED10-LED17	DIGI-KEY (R)	475-2558-1-ND
2	10UF 6.3V 20% 0603 X5R	C19,C402	DIGI-KEY (R)	490-3896-2-ND
12	475 1/8W 1% 0805	R165,R167,R169,R171,R173,R175, R177,R179,R181,R183,R185,R187	PANASONIC (R)	ERJ-6ENF4750V
2	150PF 50V 5% 0402 NPO	C49,C50	DIGI-KEY (R)	490-3229-2-ND
1	10 1/10W 1% 0402	R399	PANASONIC (R)	ERJ-2RKF10R0X
3	4700PF 50V 10% 0402 X7R	C47,C261,C263	DIGI-KEY (R)	399-3072-2-ND
1	4.7UF 50V -20%+80% 1206 Y5V	C171	DIGI-KEY (R)	490-1828-2-ND
12	49.9K 1/16W 1% 0402	R166,R168,R170,R172,R174,R176, R178,R180,R182,R184,R186,R188	DIGI-KEY (R)	541-49.9KLTR-ND

3	10UF 6.3V 20% 0402 X5R	C299-C301	DIGI-KEY (R)	445-8920-1-ND
17	0.1UF 35V 10% 0402 X7R	C46,C143,C144,C146,C147,C150, C152,C155,C160,C162,C163,C166, C170,C172,C176,C179,C185	DIGI-KEY (R)	445-6901-2-ND
6	1000 1.5A 0805	FER14-FER19	DIGI-KEY (R)	445-5223-2-ND
1	53.6K 1/16W 1% 0402	R428	DIGI-KEY (R)	541-53.6KLTR-ND
10	0.01UF 50V 10% 0402 X7R	C296-C298,C303,C305,C307,C309, C311,C313,C315	DIGI-KEY (R)	490-4762-2-ND
1	180.0K 1/16W 1% 0402	R58	DIGI-KEY (R)	541-180KLTR-ND
1	5600PF 25V 10% 0402 X7R	C112	DIGI-KEY (R)	490-5420-2-ND
12	2700PF 50V 5% 0805 COG	C186-C197	DIGI-KEY (R)	445-7508-2-ND
1	2.2UF 100V 10% 1210 X7R	C275	Kemet (R)	C1210C225K1RACTU
2	47UF 16V 20% 1210 X5R	C272,C390	MURATA (R)	GRM32ER61C476ME15L
1	1.8K 1/10W 5% 0402	R290	PANASONIC (R)	ERJ-2GEJ182X
2	39PF 50V 5% 0402 NP0	C292,C293	DIGI-KEY (R)	1276-1016-1-ND
1	18 1/10W 1% 0603	R347	PANASONIC (R)	ERJ-3EKF18R0V
3	100MA 30V 0603	D7,D8,D10	DIGI-KEY (R)	641-1282-2-ND

4	0.47UF 50V 10% 0603 X5R	C98-C101	DIGI-KEY (R)	587-3171-2-ND
10	0.033UF 50V 10% 0402 X5R	C151,C156,C157,C159,C173-C175, C180,C181,C410	DIGI-KEY (R)	445-13854-2-ND
1	0.47UF 50V 20% 0603 X7R	C167	DIGI-KEY (R)	445-5953-2-ND
4	68PF 50V 5% 0402 NPO	C70-C73	DIGI-KEY	311-1340-2- ND
6	113.0 1/4W 1% 1206	R149,R150,R159-R162	PANASONIC (R)	ERJ-8ENF1130V
1	26.7K 1/16W 1% 0402	R445	DIGI-KEY	541-26.7KLTR-ND
1	28 1/10W 1% 0402	R85	PANASONIC (R)	ERJ-2RKF28R0X
2	3.3K 1/10W 1% 0402	R147,R383	PANASONIC (R)	ERJ-2RKF3301X
1	3.3K 1/10W 1% 0402	R154	PANASONIC (R)	ERJ-2RKF3301X
1	3.74K 1/16W 1% 0402	R299	PANASONIC (R)	ERJ-2RKF3741X
4	4.02 1/16W 1% 0402	R89-R92	DIGI-KEY	541-4.02LLTR-ND
4	45.3 1/10W 1% 0402	R93,R94,R105,R106	PANASONIC (R)	ERJ-2RKF45R3X
2	619 1/10W 1% 0402	R20,R21	PANASONIC (R)	ERJ-2RKF6190X
2	0.015UF 50V 10% 0402 X7R	C406,C409	DIGI-KEY (R)	445-6894-2-ND

3	5MA MM5Z3V3T1G MM5Z3V3T1G _ZENER	D15,D17,D18	ON SEMICON (R)	MM5Z3V3T1G
1	15KV ESDA5V3SC6 SOT95P280X145-6N	D12	DIGI-KEY (R)	497-6633-1-ND
1	34 1/10W 1% 0402	R1	PANASONIC (R)	ERJ-2RKF34R0X
1	3000PF 50V 5% 0603 NP0	C267	DIGI-KEY (R)	490-6384-2-ND
6	47UF 6.3V 20% 0805 X5R	C268-C271,C273,C274	DIGI-KEY	587-1779-2-ND
2	3A PESD1CAN SMT	D1,D2	NXP (PHILI) (R)	PESD1CAN
2	510 .2A SMT	FER1,FER2	DIGI-KEY (R)	445-3958-2-ND
1	3.3UH 20% SMT	L6	COILCRAFT (R)	XAL4030-332ME
1	2.2UH 20% SMT	L8	COILCRAFT (R)	XAL5030-222ME
2	105.0 1/16W 1% 0402	R11,R12	VISHAY (R)	CRCW0402105RFKED
4	324.0 1/16W 1% 0402	R330,R344-R346	DIGI-KEY (R)	541-324LTR-ND
1	9.76K 1/10W 1% 0402	R322	PANASONIC (R)	ERJ-2RKF9761X
1	32.4K 1/10W 1% 0402	R287	PANASONIC (R)	ERJ-2RKF3242X
1	31.6K 1/10W 1% 0402	R279	PANASONIC (R)	ERJ-2RKF3162X

3	22K 1/10W 1% 0402	R300,R301,R393	PANASONIC (R)	ERJ-2RKF2202X
1	12.4K 1/10W 1% 0402	R303	PANASONIC (R)	ERJ-2RKF1242X
1	5.1K 1/10W 1% 0402	R283	PANASONIC (R)	ERJ-2RKF5101X
1	4.3K 1/10W 1% 0402	R280	PANASONIC (R)	ERJ-2RKF4301X
1	1.0UH 20% SMT	L7	COILCRAFT (R)	XAL5030-102ME
4	470 1A 0603	FER7,FER10-FER12	DIGI-KEY (R)	490-5223-2-ND
1	200 100MA CHOKE_ACT45L	FER31	TDK	ACT45L-201-2P
4	220NH 2% 0603	L1-L4	COILCRAFT	0603HP-R22XGLU
2	600 1.5A 0603	FER8,FER9	DIGI-KEY	240-2405-2-ND
2	470 2A 1806	FER5,FER6	DIGI-KEY (R)	490-1060-2-ND
2	18.2 1/10W 1% 0402	R95,R97	PANASONIC (R)	ERJ-2RKF18R2X
1	33UF 6.3V 20% 1206 X5R	C405	DIGI-KEY (R)	445-4060-2-ND
1	6.8UH 30% SMD	L12	BOURNS (R)	SRN8040-6R8Y
1	5A CDBC540-G DO214AB	D11	DIGI-KEY (R)	641-1126-2-ND
1	47UF 10V 20% 1206 POLYMER	C417	DIGI-KEY	565-3197-2-ND

3	2600 200MA ACT1210	FER26-FER28	DIGI-KEY	445-172389-1-ND
6	0.01UF 35V 10% 0402	C153,C154,C164,C165,C177,C178	DIGI-KEY	445-6900-2-ND
1	30A GSOT12 SOT23-3	D3	VISHAY SEMI	GSOT12-E3-08

## 5 Appendix B - Schematic



Please see the PDF that accompanies the Board Support Package for the full schematic.



## X-ON Electronics

Largest Supplier of Electrical and Electronic Components

*Click to view similar products for [Development Boards & Kits - Other Processors](#) category:*

*Click to view products by [Analog Devices](#) manufacturer:*

Other Similar products are found below :

[EVB-MEC1418MECC](#) [20-101-1252](#) [C29XPCIE-RDB](#) [CC-ACC-18M433](#) [MAX1464EVKIT](#) [RTE510Y470TGB00000R](#)  
[RTK0EN0001D01001BZ](#) [MAXQ622-KIT#](#) [YR0K505231S000BE](#) [YR0K50571MS000BE](#) [YQB-R5F1057A-TB](#) [QB-R5F104PJ-TB](#) [CC-](#)  
[ACC-ETHMX](#) [OV-7604-C7-EVALUATION-BOARD](#) [SK-AD02-D62Q1747TB](#) [SK-BS01-D62Q1577TB](#) [ST7MDT1-EMU2](#) [GROVE BASE](#)  
[KIT FOR RASPBERRY PI](#) [CAB M-M\(40-17-RAINBOW\)](#) [CY8CKIT-143A](#) [EK-MPC5744P](#) [KITAURIXTC234TFTTOBO1](#) [ESP32-C3-](#)  
[DEVKITC-02](#) [ENW89854AXKF](#) [ENWF9201AVEF](#) [QB-R5F104LE-TB](#) [LV18F V6 64-80-PIN TQFP MCU CARD EMPTY](#) [LV-24-33 V6](#)  
[44-PIN TQFP MCU CARD EMPTY](#) [LV-24-33 V6 64-PIN TQFP MCU CARD EMPTY](#) [LV-24-33 V6 80-PIN TQFP 1 MCU CARD EMPTY](#)  
[32X32 RGB LED MATRIX PANEL - 6MM PITCH](#) [3.3 - 5 VTRANSLATOR](#) [READY FOR XMEGA CASING \(WHITE\)](#) [RELAY4 BOARD](#)  
[ETHERNET CONNECTOR](#) [RFID CARD 125KHZ - TAG](#) [RFID READER](#) [RFM12B-DEMO](#) [MAROON](#) [3G CLICK \(FOR EUROPE AND](#)  
[AUSTRALIA\)](#) [MAX232](#) [MAX3232 BOARD](#) [ARTY S7-50](#) [THREE-AXIS ACCELEROMETER BOARD](#) [TINKERKIT HALL SENSOR](#)  
[TOUCHPANEL](#) [TOUCHPANEL CONTROLLER](#) [MIKROBOARD FOR AVR WITH ATMEGA128](#) [MIKROBOARD FOR PSOC WITH](#)  
[CY8C27643](#) [MIKROBUS CAPE](#)