

CMP401/CMP402

FEATURES

- 23 ns or 65 ns Propagation Delay
- Single-Supply Operation
- Compatible with 3 V and 5 V Logic
- Separate Input and Output Sections
- Low Power
- Wide Input Range: -5 V to +3.9 V

APPLICATIONS

- Battery-Operated Instrumentation
- Line Receivers
- Level Translators
- Read Channel Detection

FUNCTIONAL BLOCK DIAGRAM

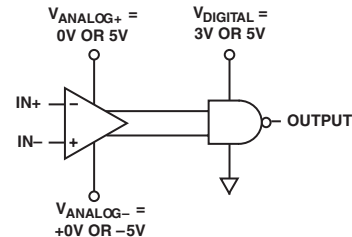

NOTE: $(V_{ANALOG+}) - (V_{ANALOG-}) \geq 3V$

GENERAL DESCRIPTION

The CMP401 and CMP402 are 23 ns and 65 ns quad comparators with separate input and output supplies. Separate supplies enable the input stage to be operated from +3 V to as high as ± 6 V. The output can be supplied with either 3 V or 5 V as determined by the interface logic or available supplies. Independent input and output supplies combined with fast propagation make the CMP401 and CMP402 excellent choices for interfacing to portable instrumentation.

The CMP401 and CMP402 are specified over the extended industrial (-40°C to $+125^{\circ}\text{C}$) temperature range. Both are available in narrow 16-lead SOIC surface-mount packages and 16-lead TSSOP.

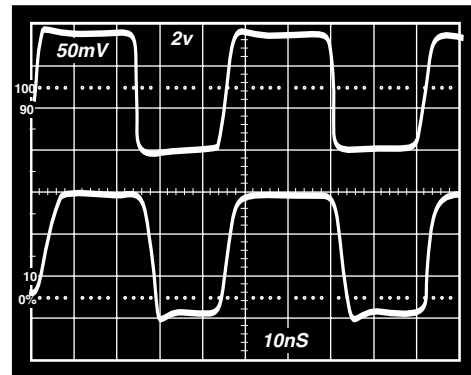

CMP401: 20 MHz Noninverting Switching, $V_{IN} = \pm 100$ mV

REV. B

Information furnished by Analog Devices is believed to be accurate and reliable. However, no responsibility is assumed by Analog Devices for its use, nor for any infringements of patents or other rights of third parties that may result from its use. No license is granted by implication or otherwise under any patent or patent rights of Analog Devices.

CMP401/CMP402—SPECIFICATIONS

ELECTRICAL SPECIFICATIONS (@ $V_{+ANA} = V_{+DIG} = 5.0\text{ V}$, $V_{CM} = 0.1\text{ V}$, $-40^{\circ}\text{C} \leq T_A \leq +125^{\circ}\text{C}$, unless otherwise noted.)

Parameter	Symbol	Conditions	Min	Typ	Max	Unit
INPUT CHARACTERISTICS						
Offset Voltage ¹	V_{OS}	$T_A = 25^{\circ}\text{C}$			3	mV
	V_{OS}				4	mV
Hysteresis				2		mV
Input Bias Current	I_B	$T_A = 25^{\circ}\text{C}$			3	μA
	I_B				4	μA
Input Offset Current	I_{OS}				± 3	μA
Input Common-Mode Voltage Range	V_{CM}		0		4.0	V
Common-Mode Rejection	CMRR	$0.1\text{ V} \leq V_{CM} \leq 3.9\text{ V}$	60			dB
Large-Signal Voltage Gain	A_{VO}	$R_L = 10\text{ k}\Omega$		10		V/mV
Offset Voltage Drift	$\Delta V_{OS}/\Delta T$			1		$\mu\text{V}/^{\circ}\text{C}$
OUTPUT CHARACTERISTICS						
Output High Voltage	V_{OH}	$I_{OH} = -3.2\text{ mA}$	4.6			V
Output Low Voltage	V_{OL}	$I_{OL} = 3.2\text{ mA}$			0.2	V
POWER SUPPLY						
Power Supply Rejection Ratio	PSRR	V_{+ANA} and V_{+DIG} 2.7 V to 6 V	60			dB
Analog Supply Current – CMP401	I_{ANA}	$T_A = 25^{\circ}\text{C}$			6.5	mA
Digital Supply Current – CMP401	I_{DIG}	$V_O = 0\text{ V}$, $R_L = \infty$, $T_A = 25^{\circ}\text{C}$			2.0	mA
Analog Supply Current – CMP401	I_{ANA}				8.0	mA
Digital Supply Current – CMP401	I_{DIG}	$V_O = 0\text{ V}$, $R_L = \infty$			2.25	mA
Analog Supply Current – CMP402	I_{ANA}	$T_A = 25^{\circ}\text{C}$			1.4	mA
Digital Supply Current – CMP402	I_{DIG}	$V_O = 0\text{ V}$, $R_L = \infty$, $T_A = 25^{\circ}\text{C}$			2.0	mA
Analog Supply Current – CMP402	I_{ANA}				1.75	mA
Digital Supply Current – CMP402	I_{DIG}	$V_O = 0\text{ V}$, $R_L = \infty$			2.25	mA
DYNAMIC PERFORMANCE						
Propagation Delay – CMP401	t_p	100 mV Step with 20 mV OD $T_A = 25^{\circ}\text{C}$		17	23	ns
	t_p	100 mV Step with 5 mV OD $T_A = 25^{\circ}\text{C}$		33		ns
Propagation Delay – CMP402	t_p	100 mV Step with 20 mV OD $T_A = 25^{\circ}\text{C}$			30	ns
	t_p	100 mV Step with 20 mV OD $T_A = 25^{\circ}\text{C}$		54	65	ns
	t_p	100 mV Step with 5 mV OD $T_A = 25^{\circ}\text{C}$		60		ns
	t_p	100 mV Step with 20 mV OD			75	ns

ELECTRICAL SPECIFICATIONS (@ $V_{ANA} = V_{DIG} = 3.0\text{ V}$, $V_{CM} = 0.1\text{ V}$, $T_A = 25^{\circ}\text{C}$, unless otherwise noted.)

Parameter	Symbol	Conditions	Min	Typ	Max	Unit
INPUT CHARACTERISTICS						
Offset Voltage ¹	V_{OS}				4.5	mV
Input Common-Mode Voltage Range	V_{CM}		0		2.0	V
Input Differential Voltage Range	V_{DIFF}		± 2.0			V
Common-Mode Rejection	CMRR	$0.1\text{ V} \leq V_{CM} \leq 1.9\text{ V}$	60			dB
OUTPUT CHARACTERISTICS						
Output High Voltage	V_{OH}	$I_{OH} = -3.2\text{ mA}$	2.6			V
Output Low Voltage	V_{OL}	$I_{OL} = 3.2\text{ mA}$			0.25	V
POWER SUPPLY						
Power Supply Rejection Ratio	PSRR	V_{+ANA} and V_{+DIG} 2.7 V to 6 V	60			dB
Analog Supply Current – CMP401	I_{ANA}				6	mA
Digital Supply Current – CMP401	I_{DIG}	$V_O = 0\text{ V}$, $R_L = \infty$			1	mA
Analog Supply Current – CMP402	I_{ANA}				1.2	mA
Digital Supply Current – CMP402	I_{DIG}	$V_O = 0\text{ V}$, $R_L = \infty$			1	mA
DYNAMIC PERFORMANCE						
Propagation Delay – CMP401	t_p	100 mV Step with 20 mV OD		32		ns
Propagation Delay – CMP402	t_p	100 mV Step with 20 mV OD		70		ns

ELECTRICAL SPECIFICATIONS (@ $V_{\pm ANA} = \pm 5\text{ V}$, $V_{DIG} = 5.0\text{ V}$, $T_A = 25^\circ\text{C}$, unless otherwise noted.)

Parameter	Symbol	Conditions	Min	Typ	Max	Unit
INPUT CHARACTERISTICS						
Offset Voltage ¹	V_{OS}	$V_{CM} = 0\text{ V}$			3	mV
Input Common-Mode Voltage Range	V_{CM}		-5.0		+4.0	V
Input Differential Voltage Range	V_{DIFF}		± 8.0			V
Common-Mode Rejection	CMRR	$-4.9\text{ V} \leq V_{CM} \leq 3.9\text{ V}$	60			dB
Offset Voltage Drift	$\Delta V_{OS}/\Delta T$			1	5	$\mu\text{V}/^\circ\text{C}$
POWER SUPPLY						
Power Supply Rejection Ratio	PSRR	$V_{\pm ANA} \pm 3\text{ V}$ to $\pm 6\text{ V}$	60			dB
Analog Supply Current – CMP401	I_{ANA}				6.5	mA
Digital Supply Current – CMP401	I_{DIG}	$V_O = 0\text{ V}$, $R_L = \infty$			2.0	mA
Analog Supply Current – CMP402	I_{ANA}				2.0	mA
Digital Supply Current – CMP402	I_{DIG}	$V_O = 0\text{ V}$, $R_L = \infty$			2.0	mA
DYNAMIC PERFORMANCE						
Propagation Delay – CMP401	t_p	100 mV Step with 20 mV OD			23	ns
Propagation Delay – CMP402	t_p	100 mV Step with 20 mV OD			65	ns

NOTES

¹Offset voltage is defined as $(V_{OS+} + V_{OS-})/2$.

Specifications subject to change without notice.

CMP401/CMP402

ABSOLUTE MAXIMUM RATINGS¹

Total Analog Supply Voltage	16 V
Digital Supply Voltage	7 V
Analog Positive Supply—Digital Positive Supply	-200 mV
Input Voltage ²	±7 V
Differential Input Voltage	±9 V
Output Short-Circuit Duration to GND	Indefinite
Storage Temperature Range	
S, RU Package	-65°C to +150°C
Operating Temperature Range	
CMP401G, CMP402G	-40°C to +125°C
Junction Temperature Range	
S, RU Package	-65°C to +150°C
Lead Temperature Range (Soldering 60 sec)	300°C

Package Type	θ_{JA} ³	θ_{JC}	Units
16-Lead SOIC (S)	113	37	°C/W
16-Lead TSSOP (RU)	180	37	°C/W

NOTES

- ¹Absolute Maximum Ratings apply to packaged parts, unless otherwise noted.
²The analog input voltage is equal to ±7 V or the analog supply voltage, whichever is less.
³ θ_{JA} is specified for the worst-case conditions, i.e., θ_{JA} is specified for device soldered in circuit board for SOIC and TSSOP packages.

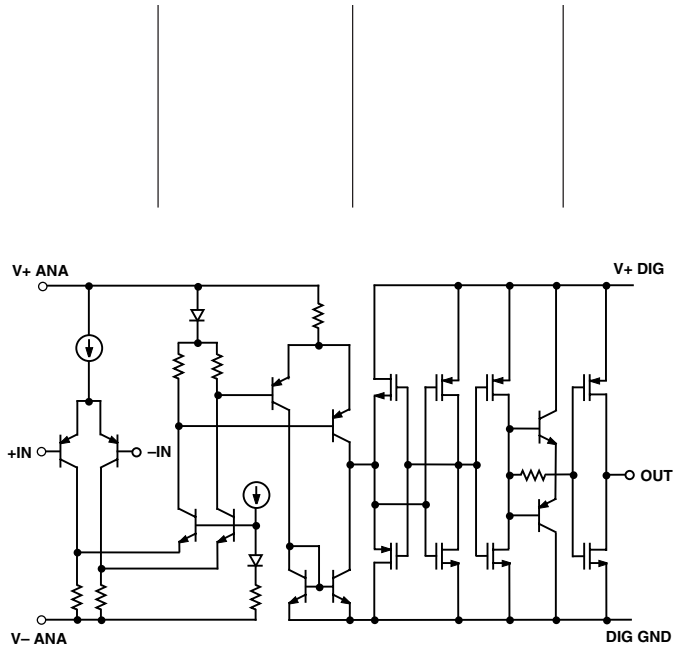
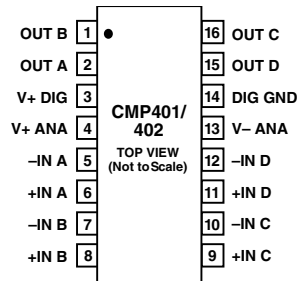

Figure 1. Simplified Schematic

PIN CONFIGURATIONS

16-Lead Narrow-SOIC (S-Suffix)



16-Lead TSSOP (RU-Suffix)

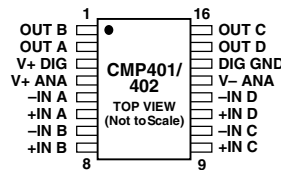

CAUTION

ESD (electrostatic discharge) sensitive device. Electrostatic charges as high as 4000 V readily accumulate on the human body and test equipment and can discharge without detection. Although the CMP401/CMP402 features proprietary ESD protection circuitry, permanent damage may occur on devices subjected to high-energy electrostatic discharges. Therefore, proper ESD precautions are recommended to avoid performance degradation or loss of functionality.



Revision History

Location	Page
Data Sheet changed from REV. A to REV. B.	
Changed SO-16 to 16-Lead SOIC	Throughout
Moved Revision History	4
Moved Outline Dimensions	8
Updated Outline Dimensions	8
Changes to Ordering Guide	8

Location	Page
Data Sheet changed from REV. 0 to REV. A.	
Edits to GENERAL DESCRIPTION	1
Edits to ABSOLUTE MAXIMUM RATINGS	4
Edits to PACKAGE TYPE	4
Edits to ORDERING GUIDE	4
Deleted DICE CHARACTERISTICS	4
Edits to CMP401/CMP402 PIN CONFIGURATIONS	4

Typical Performance Characteristics—CMP401/CMP402

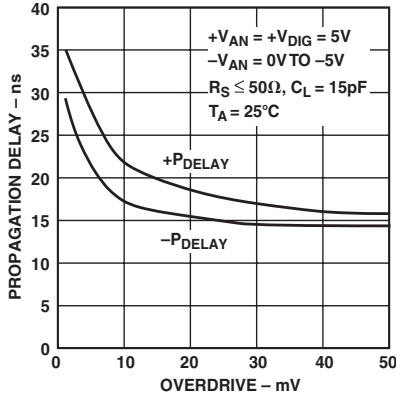

TPC 1. CMP401 Propagation Delay vs. Overdrive

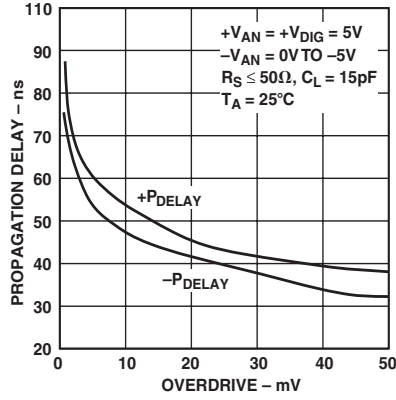

TPC 2. CMP402 Propagation Delay vs. Overdrive

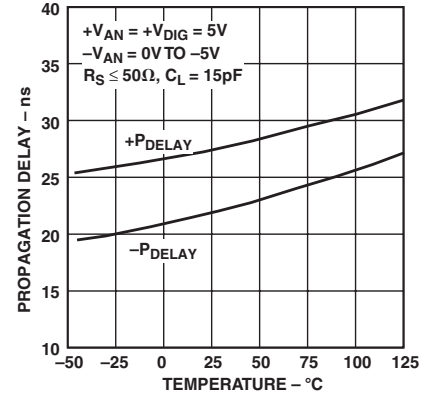

TPC 3. CMP401 Propagation Delay vs. Temperature - 5 mV OD

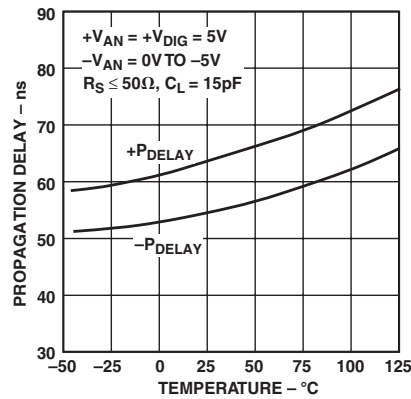

TPC 4. CMP402 Propagation Delay vs. Temperature - 5 mV OD

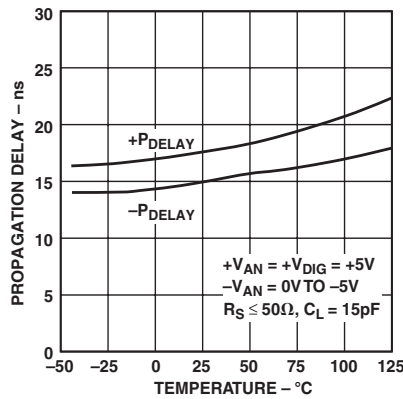

TPC 5. CMP401 Propagation Delay vs. Temperature - 20 mV OD

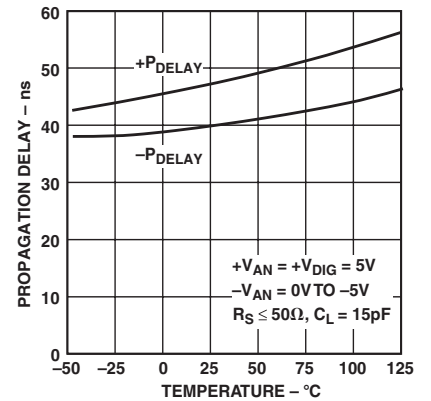

TPC 6. CMP402 Propagation Delay vs. Temperature - 20 mV OD

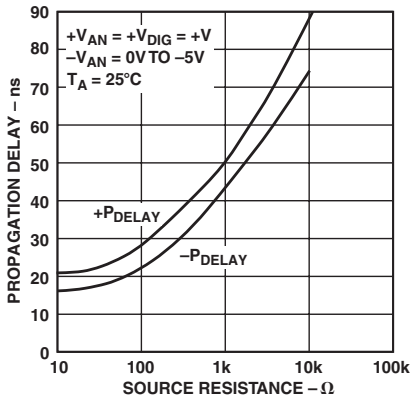

TPC 7. CMP401 Propagation Delay vs. Source Resistance - 20 mV OD

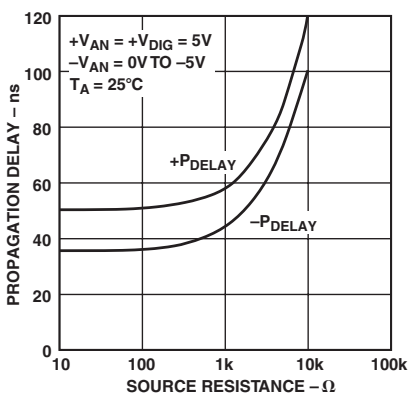

TPC 8. CMP402 Propagation Delay vs. Source Resistance - 20 mV OD

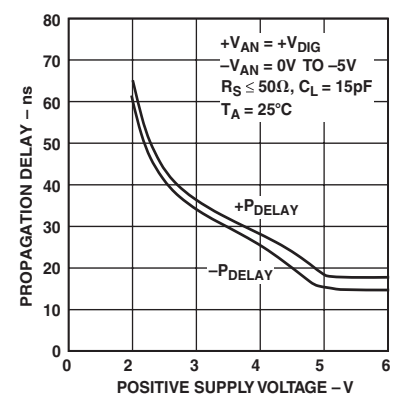

TPC 9. CMP401 Propagation Delay vs. Supply Voltage - 20 mV OD

CMP401/CMP402

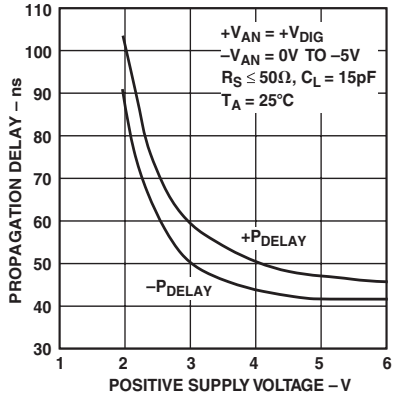

TPC 10. CMP402 Propagation Delay vs. Supply Voltage – 20 mV OD

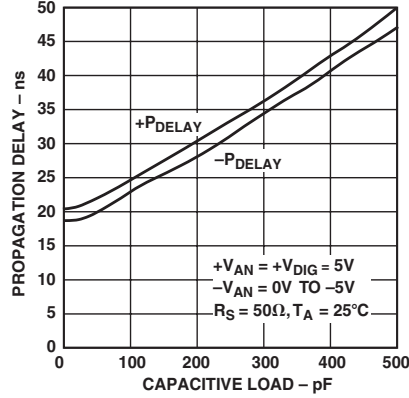

TPC 11. CMP401 Propagation Delay vs. Capacitive Load

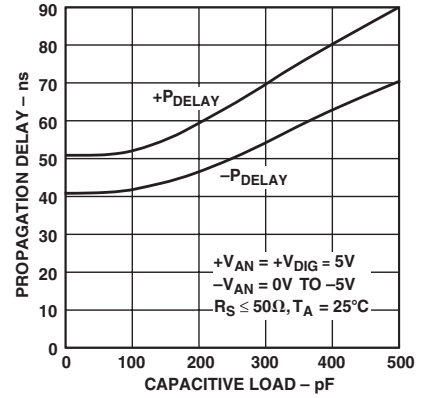

TPC 12. CMP402 Propagation Delay vs. Capacitive Load

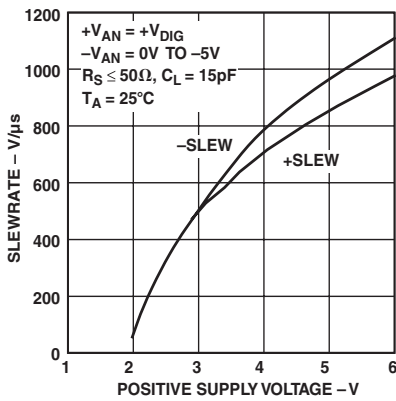

TPC 13. CMP401/CMP402 Slew Rate vs. Positive Supply Voltage

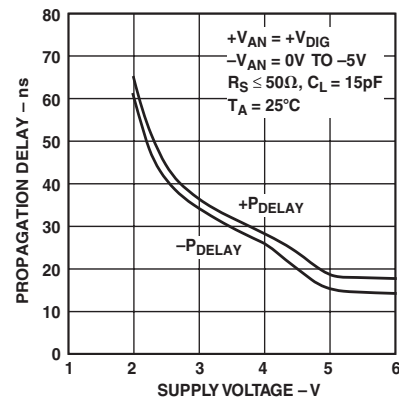

TPC 14. CMP401 Propagation Delay vs. Supply Voltage

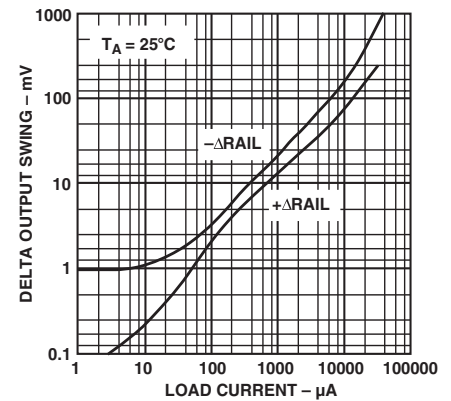

TPC 15. CMP401/CMP402 Delta Output Swing from Power Supplies vs. Load Current

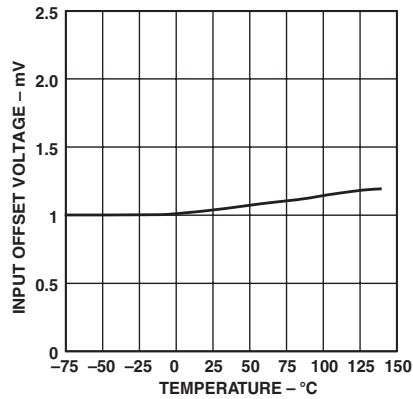

TPC 16. CMP401/CMP402 Input Offset Voltage vs. Temperature

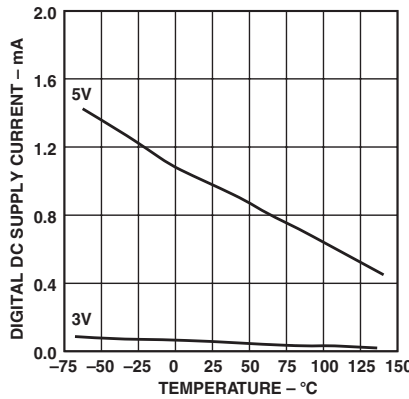

TPC 17. CMP401 Digital Supply Current vs. Temperature

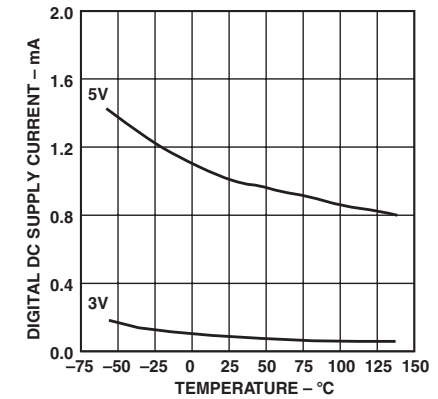

TPC 18. CMP402 Digital Supply Current vs. Temperature

Typical Performance Characteristics—CMP401/CMP402

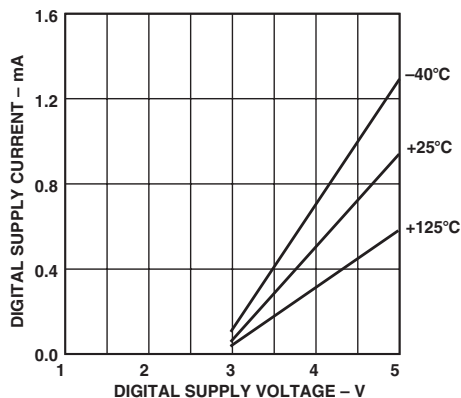

TPC 19. CMP401 Digital Supply Current vs. Digital Supply Voltage

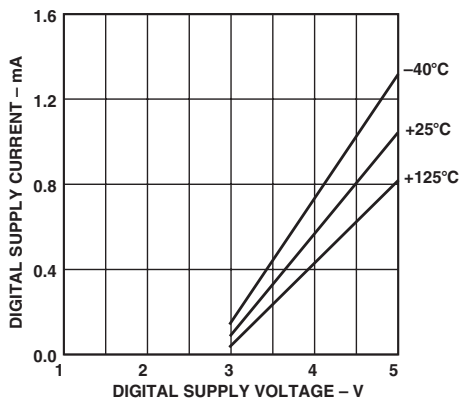

TPC 20. CMP402 Digital Supply Current vs. Digital Supply Voltage

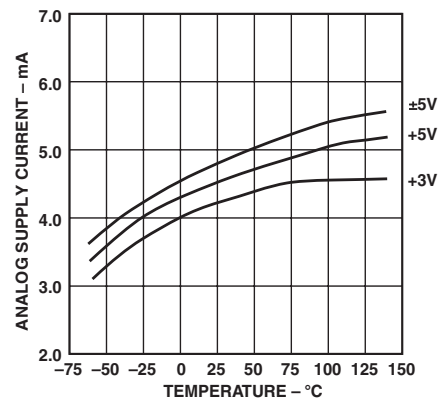

TPC 21. CMP401 Analog Supply Current vs. Temperature

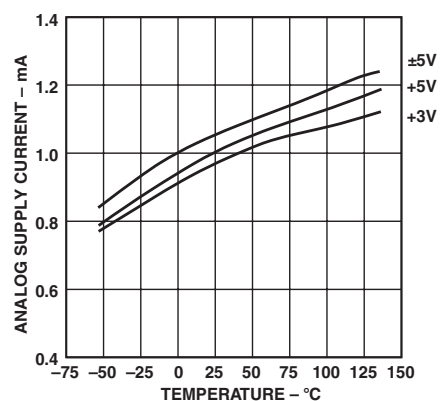

TPC 22. CMP402 Analog Supply Current vs. Temperature

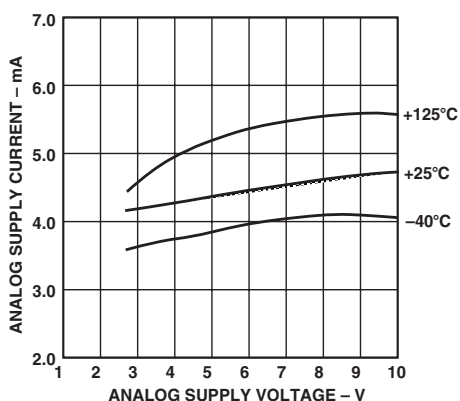

TPC 23. CMP401 Analog Supply Current vs. Analog Supply Voltage

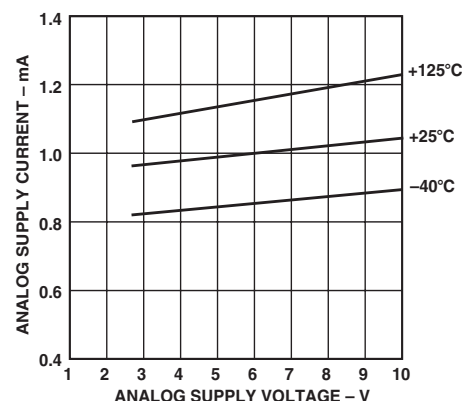

TPC 24. CMP402 Analog Supply Current vs. Analog Supply Voltage

OUTLINE DIMENSIONS

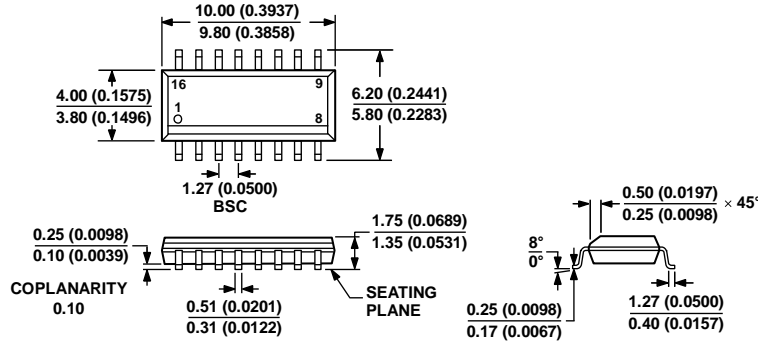

COMPLIANT TO JEDEC STANDARDS MS-012-AC
 CONTROLLING DIMENSIONS ARE IN MILLIMETERS; INCH DIMENSIONS
 (IN PARENTHESES) ARE ROUNDED-OFF MILLIMETER EQUIVALENTS FOR
 REFERENCE ONLY AND ARE NOT APPROPRIATE FOR USE IN DESIGN.

060906-A

Figure 1. 16-Lead Standard Small Outline Package [SOIC_N]
 Narrow Body
 (R-16)
 S-Suffix

Dimensions shown in millimeters and (inches)

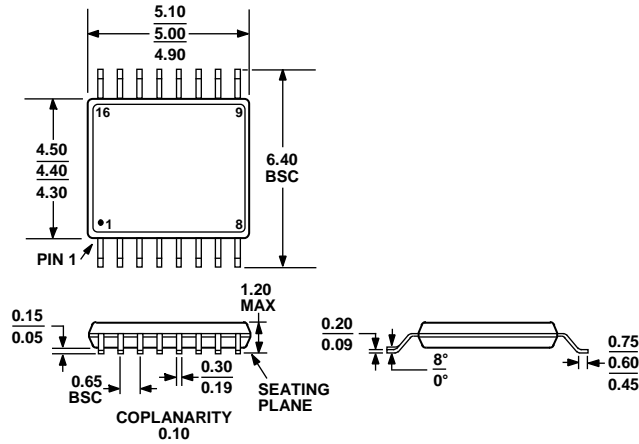

COMPLIANT TO JEDEC STANDARDS MO-153-AB

Figure 2. 16-Lead Thin Shrink Small Outline Package [TSSOP]
 (RU-16)

Dimensions shown in millimeters

ORDERING GUIDE

Model ¹	Temperature Range	Package Description	Package Option
CMP401GRUZ-REEL	-40°C to +125°C	16-Lead Thin Shrink Small Outline Package [TSSOP]	RU-16
CMP401GSZ	-40°C to +125°C	16-Lead Standard Small Outline Package [SOIC_N]	R-16
CMP401GSZ-REEL	-40°C to +125°C	16-Lead Standard Small Outline Package [SOIC_N]	R-16
CMP402GRUZ-REEL	-40°C to +125°C	16-Lead Thin Shrink Small Outline Package [TSSOP]	RU-16
CMP402GSZ	-40°C to +125°C	16-Lead Standard Small Outline Package [SOIC_N]	R-16
CMP402GSZ-REEL	-40°C to +125°C	16-Lead Standard Small Outline Package [SOIC_N]	R-16

¹ Z = RoHS Compliant Part.

X-ON Electronics

Largest Supplier of Electrical and Electronic Components

Click to view similar products for [Analog Comparators](#) category:

Click to view products by [Analog Devices](#) manufacturer:

Other Similar products are found below :

[SC2903VDR2G](#) [LM2901SNG](#) [LM339SNG](#) [UPC272G2-A](#) [55122](#) [5962-8757203IA](#) [NTE911](#) [5962-8751601DA](#) [LM339EDR2G](#) [NTE922](#)
[LM2903M/TR](#) [MAX49140AXK/V+T](#) [LM2903F-E2](#) [MCP6544-EP](#) [LM2901EDR2G](#) [TS391SN2T1G](#) [LM111JG](#) [LM139ADT](#) [LM239APT](#)
[HMC675LC3CTR](#) [MAX9024AUD+](#) [LT6700HVIS6-2#TRMPBF](#) [ADCMP394ARZ-RL7](#) [LM339AMX](#) [LTC1440IMS8#PBF](#) [AZV331KSTR-](#)
[G1](#) [LTC1841IS8#PBF](#) [LTC1440CN8#PBF](#) [LTC1542CS8#PBF](#) [LTC1445CS#PBF](#) [TL331VSN4T3G](#) [LT6700IDCB-1#TRMPBF](#)
[LTC1042CN8#PBF](#) [LTC1540CMS8#PBF](#) [ADCMP607BCPZ-R7](#) [LT1720CDD#PBF](#) [LTC1040CN#PBF](#) [LT6700MPDCB-1#TRMPBF](#)
[LT6700IDCB-3#TRMPBF](#) [LTC1440IS8#PBF](#) [S-89431ACNC-HBVTFG](#) [NTE1718](#) [NTE943](#) [NTE943M](#) [NTE943SM](#) [TA75S393F,LF\(T](#)
[ALD2301APAL](#) [ALD2302APAL](#) [AD790JNZ](#) [AD8465WBCPZ-WP](#)