

# Ultralow EMI 28V<sub>IN</sub>, 6A DC/DC μModule Regulator

## FEATURES

- Complete Low EMI Switch Mode Power Supply
- Wide Input Voltage Range: 4.5V to 28V
- 6A DC Typical, 8A Peak Output Current
- 0.6V to 5V Output Voltage Range
- EN55022 Class B Certified
- Output Voltage Tracking and Margining
- PLL Frequency Synchronization
- ±1.75% Total DC Error
- Power Good Output
- Current Foldback Protection (Disabled at Start-Up)
- Parallel/Current Sharing
- Current Mode Control
- Up to 93% Efficiency at 5V<sub>IN</sub>, 3.3V<sub>OUT</sub>
- Programmable Soft-Start
- Output Overvoltage Protection
- -55°C to 125°C Operating Temperature Range (LTM4606MP)
- SnPb or RoHS Compliant Finish
- 15mm × 15mm × 2.82mm LGA Package  
15mm × 15mm × 3.42mm BGA Package

## APPLICATIONS

- ASICs or FPGA Transceivers
- Telecom, Servers and Networking Equipment
- Industrial Equipment
- RF Equipment

## DESCRIPTION

The **LTM<sup>®</sup>4606** is a complete EN55022 Class B certified noise high voltage 6A switching mode DC/DC power supply. Included in the package are the switching controller, power FETs, inductor, and all support components. The on-board input filter and noise cancellation circuits achieve low noise operation, thus effectively reducing the electromagnetic interference (EMI). Operating over an input voltage range of 4.5V to 28V, the LTM4606 supports an output voltage range of 0.6V to 5V, set by a single resistor. This high efficiency design delivers 6A continuous current (8A peak). Only bulk input and output capacitors are needed to finish the design.

High switching frequency and an adaptive on-time current mode architecture enables a very fast transient response to line and load changes without sacrificing stability. The device supports output voltage tracking and output voltage margining.

Furthermore, the μModule<sup>®</sup> regulator can be synchronized with an external clock for reducing undesirable frequency harmonics and allows PolyPhase<sup>®</sup> operation for high load currents.

The LTM4606 is offered in space saving 15mm × 15mm × 2.82mm LGA and 15mm × 15mm × 3.42mm BGA packages. The LTM4606 is available with SnPb (BGA) or RoHS compliant terminal finish.

All registered trademarks and trademarks are the property of their respective owners. Protected by U.S. patents, including 5481178, 5847554, 6304066, 6476589, 6580258, 6677210, 6774611, 8163643.

## TYPICAL APPLICATION

**Ultralow Noise 2.5V/6A Power Supply with 4.5V to 28V Input**

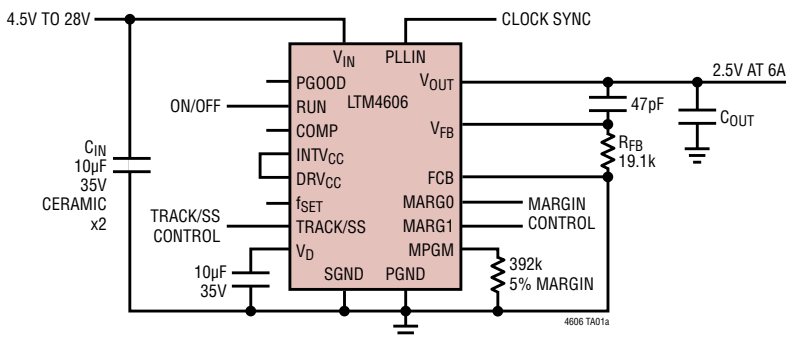

**Radiated Emission Scan at 12V<sub>IN</sub>, 2.5V<sub>OUT</sub>/6A**

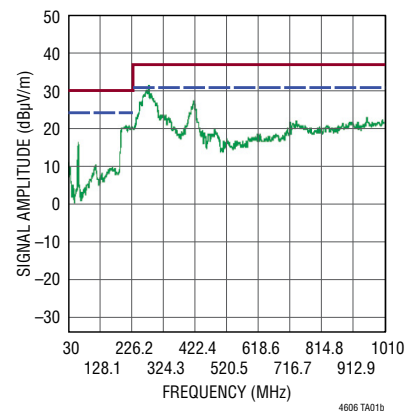

# LTM4606

## ABSOLUTE MAXIMUM RATINGS

(Note 1)

$DRV_{CC}$ ,  $V_{OUT}$  ..... -0.3V to 6V  
 $PLLIN$ ,  $FCB$ ,  $TRACK/SS$ ,  $MPGM$ ,  $MARG0$ ,  
 $MARG1$ ,  $PGOOD$ ,  $RUN$  ..... -0.3V to  $INTV_{CC} + 0.3V$   
 $V_{FB}$ ,  $COMP$  ..... -0.3V to 2.7V  
 $V_{IN}$ ,  $V_D$  ..... -0.3V to 28V

Internal Operating Temperature Range (Note 2)  
 E and I Grades ..... -40°C to 125°C  
 MP Grade ..... -55°C to 125°C  
 Junction Temperature ..... 125°C  
 Storage Temperature Range ..... -55°C to 125°C

## PIN CONFIGURATION

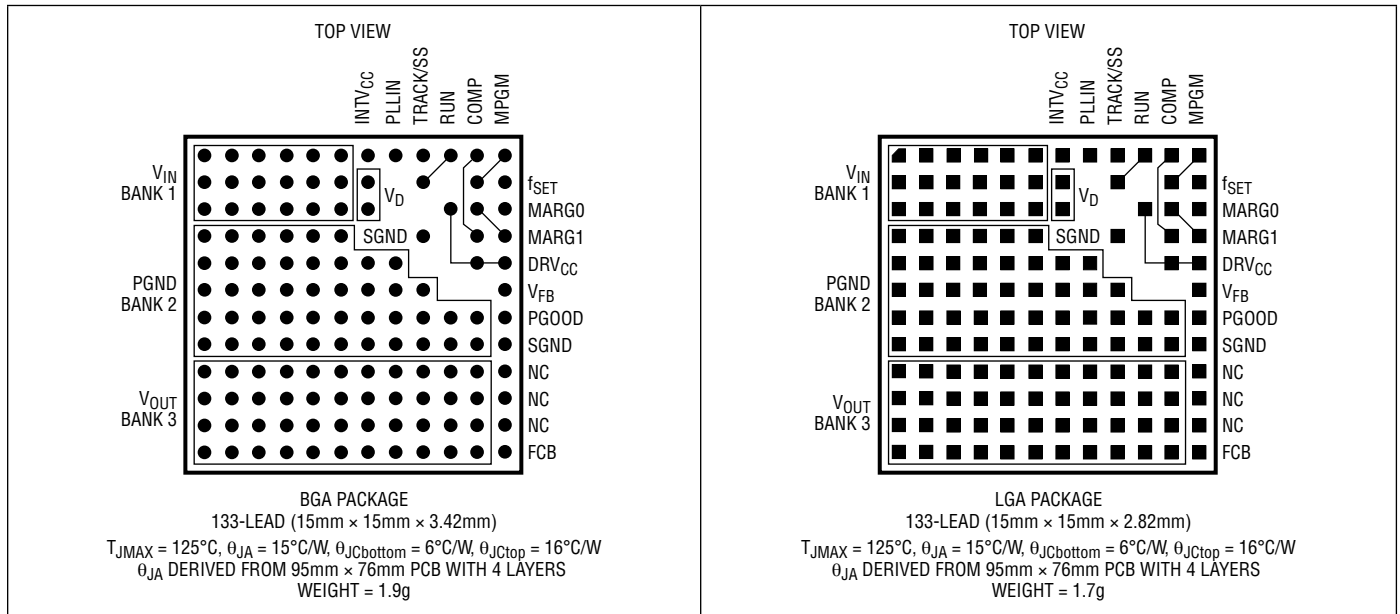

## ORDER INFORMATION

PART NUMBER	PAD OR BALL FINISH	PART MARKING*		PACKAGE TYPE	MSL RATING	TEMPERATURE RANGE (Note 2)
		DEVICE	FINISH CODE			
LTM4606EV#PBF	Au (RoHS)	LTM4606V	e4	LGA	3	-40°C to 125°C
LTM4606IV#PBF	Au (RoHS)	LTM4606V	e4	LGA	3	-40°C to 125°C
LTM4606MPV#PBF	Au (RoHS)	LTM4606MPV	e4	LGA	3	-55°C to 125°C
LTM4606EY#PBF	SAC305 (RoHS)	LTM4606Y	e1	BGA	3	-40°C to 125°C
LTM4606IY#PBF	SAC305 (RoHS)	LTM4606Y	e1	BGA	3	-40°C to 125°C
LTM4606IY	SnPb (63/37)	LTM4606Y	e0	BGA	3	-40°C to 125°C
LTM4606MPY#PBF	SAC305 (RoHS)	LTM4606Y	e1	BGA	3	-55°C to 125°C
LTM4606MPY	SnPb (63/37)	LTM4606Y	e0	BGA	3	-55°C to 125°C

• Contact the factory for parts specified with wider operating temperature ranges. \*Pad or ball finish code is per IPC/JEDEC J-STD-609.

- [Recommended LGA and BGA PCB Assembly and Manufacturing Procedures](#)
- [LGA and BGA Package and Tray Drawings](#)

**ELECTRICAL CHARACTERISTICS** The ● denotes the specifications which apply over the specified internal operating temperature range, otherwise specifications are at  $T_A = 25^\circ\text{C}$  (Note 2).  $V_{IN} = 12\text{V}$ , unless otherwise noted. Per typical application (front page) configuration,  $R_{FB} = 40.2\text{k}$ .

SYMBOL	PARAMETER	CONDITIONS	MIN	TYP	MAX	UNITS	
$V_{IN(DC)}$	Input DC Voltage		●	4.5	28	V	
$V_{OUT(DC)}$	Output Voltage, Total Variation with Line and Load	$C_{IN} = 10\mu\text{F} \times 2$ , $C_{OUT} = 200\mu\text{F}$ ; $FCB = 0$ $V_{IN} = 5\text{V}$ to $28\text{V}$ , $I_{OUT} = 0\text{A}$ to $6\text{A}$ , (Note 4)	●	1.474	1.5	1.526	V
<b>Input Specifications</b>							
$V_{IN(UVLO)}$	Undervoltage Lockout Threshold	$I_{OUT} = 0\text{A}$		3.2	4	V	
$I_{INRUSH(VIN)}$	Input Inrush Current at Start-Up	$I_{OUT} = 0\text{A}$ , $C_{IN} = 10\mu\text{F} \times 2$ , $C_{OUT} = 200\mu\text{F}$ , $V_{OUT} = 1.5\text{V}$ $V_{IN} = 5\text{V}$ $V_{IN} = 12\text{V}$		0.6 0.7		A A	
$I_{Q(VIN)}$	Input Supply Bias Current	$V_{IN} = 5\text{V}$ , $V_{OUT} = 1.5\text{V}$ , Switching Continuous $V_{IN} = 12\text{V}$ , $V_{OUT} = 1.5\text{V}$ , Switching Continuous Shutdown, $RUN = 0$ , $V_{IN} = 12\text{V}$		27 25 22		mA mA $\mu\text{A}$	
$I_S(VIN)$	Input Supply Current	$V_{IN} = 12\text{V}$ , $V_{OUT} = 1.5\text{V}$ , $I_{OUT} = 6\text{A}$ $V_{IN} = 5\text{V}$ , $V_{OUT} = 1.5\text{V}$ , $I_{OUT} = 6\text{A}$		0.96 2.18		A A	
$INTV_{CC}$	$V_{IN} = 12\text{V}$ , $RUN > 2\text{V}$	No Load		4.7	5	5.3	V
<b>Output Specifications</b>							
$I_{OUT(DC)}$	Output Continuous Current Range	$V_{IN} = 12\text{V}$ , $V_{OUT} = 1.5\text{V}$ (Note 4)		0	6	A	
$\Delta V_{OUT(LINE)}/V_{OUT}$	Line Regulation Accuracy	$V_{OUT} = 1.5\text{V}$ , $FCB = 0\text{V}$ , $V_{IN} = 4.5\text{V}$ to $28\text{V}$ , $I_{OUT} = 0\text{A}$	●	0.05	0.3	%	
$\Delta V_{OUT(LOAD)}/V_{OUT}$	Load Regulation Accuracy	$V_{OUT} = 1.5\text{V}$ , $FCB = 0\text{V}$ , $I_{OUT} = 0\text{A}$ to $6\text{A}$ $V_{IN} = 12\text{V}$ (Note 4)	●		0.3	%	
$V_{IN(AC)}$	Input Ripple Voltage	$I_{OUT} = 0\text{A}$ , $C_{IN} = 10\mu\text{F}$ X5R Ceramic $\times 3$ and $100\mu\text{F}$ Electrolytic $V_{IN} = 5\text{V}$ , $V_{OUT} = 1.5\text{V}$ $V_{IN} = 12\text{V}$ , $V_{OUT} = 1.5\text{V}$		2 3		mV <sub>p-p</sub> mV <sub>p-p</sub>	
$V_{OUT(AC)}$	Output Ripple Voltage	$I_{OUT} = 0\text{A}$ , $C_{OUT} = 22\mu\text{F}$ X5R Ceramic $\times 3$ and $100\mu\text{F}$ X5R Ceramic $V_{IN} = 5\text{V}$ , $V_{OUT} = 1.5\text{V}$ $V_{IN} = 12\text{V}$ , $V_{OUT} = 1.5\text{V}$		8 11		mV <sub>p-p</sub> mV <sub>p-p</sub>	
$f_S$	Output Ripple Voltage Frequency	$I_{OUT} = 5\text{A}$ , $V_{IN} = 12\text{V}$ , $V_{OUT} = 1.5\text{V}$		900		kHz	
$\Delta V_{OUT(START)}$	Turn-On Overshoot	$C_{OUT} = 200\mu\text{F}$ , $V_{OUT} = 1.5\text{V}$ , $I_{OUT} = 0\text{A}$ , $TRACK/SS = 10\text{nF}$ $V_{IN} = 12\text{V}$ $V_{IN} = 5\text{V}$		20 20		mV mV	
$t_{START}$	Turn-On Time	$C_{OUT} = 200\mu\text{F}$ ; $V_{OUT} = 1.5\text{V}$ , $TRACK/SS =$ Open $I_{OUT} = 1\text{A}$ Resistive Load $V_{IN} = 5\text{V}$ $V_{IN} = 12\text{V}$		0.5 0.5		ms ms	
$\Delta V_{OUT(LS)}$	Peak Deviation for Dynamic Load	Load: 0% to 50% to 0% of Full Load $C_{OUT} = 22\mu\text{F}$ Ceramic, $470\mu\text{F} \times 2$ $V_{IN} = 12\text{V}$ $V_{OUT} = 1.5\text{V}$		35		mV	
$t_{SETTLE}$	Settling Time for Dynamic Load Step	Load: 0% to 50% to 0% of Full Load, $V_{IN} = 12\text{V}$		25		$\mu\text{s}$	
$I_{OUT(PK)}$	Output Current Limit	$C_{OUT} = 200\mu\text{F}$ $V_{IN} = 5\text{V}$ , $V_{OUT} = 1.5\text{V}$ $V_{IN} = 12\text{V}$ , $V_{OUT} = 1.5\text{V}$		10 10		A A	

## ELECTRICAL CHARACTERISTICS

The ● denotes the specifications which apply over the specified internal operating temperature range, otherwise specifications are at  $T_A = 25^\circ\text{C}$  (Note 2).  $V_{IN} = 12\text{V}$ , unless otherwise noted. Per typical application (front page) configuration,  $R_{FB} = 40.2\text{k}$ .

SYMBOL	PARAMETER	CONDITIONS		MIN	TYP	MAX	UNITS
<b>Control Section</b>							
$V_{FB}$	Voltage at $V_{FB}$ Pin	$I_{OUT} = 0\text{A}$ , $V_{OUT} = 1.5\text{V}$	●	0.591	0.6	0.609	V
$V_{RUN}$	RUN Pin On/Off Threshold			1	1.5	1.9	V
$I_{TRACK/SS}$	Soft-Start Charging Current	$V_{TRACK/SS} = 0\text{V}$		-1	-1.5	-2	$\mu\text{A}$
$V_{FCB}$	Forced Continuous Threshold			0.57	0.6	0.63	V
$I_{FCB}$	Forced Continuous Pin Current	$V_{FCB} = 0\text{V}$			-1	-2	$\mu\text{A}$
$t_{ON(MIN)}$	Minimum On Time	(Note 3)			50	100	ns
$t_{OFF(MIN)}$	Minimum Off Time	(Note 3)			250	400	ns
$R_{PLLIN}$	PLLIN Input Resistor				50		$\text{k}\Omega$
$I_{DRVCC}$	Current into $DRV_{CC}$ Pin	$V_{OUT} = 1.5\text{V}$ , $I_{OUT} = 1\text{A}$ , $DRV_{CC} = 5\text{V}$			15	25	$\text{mA}$
$R_{FBHI}$	Resistor Between $V_{OUT}$ and $V_{FB}$ Pins			60.098	60.4	60.702	$\text{k}\Omega$
$V_{RUN(MAX)}$	Maximum RUN Pin Voltage	5.1V Zener Clamp			5		V
<b>Margin Section</b>							
$V_{MPGM}$	Margin Reference Voltage				1.18		V
$V_{MARG0}$ , $V_{MARG1}$	MARG0, MARG1 Voltage Threshold				1.4		V
<b>PGOOD</b>							
$\Delta V_{FBH}$	PGOOD Upper Threshold	$V_{FB}$ Rising		7	10	13	%
$\Delta V_{FBL}$	PGOOD Lower Threshold	$V_{FB}$ Falling		-7	-10	-13	%
$\Delta V_{FB(HYS)}$	PGOOD Hysteresis	$V_{FB}$ Returning			1.5		%
$V_{PGL}$	PGOOD Low Voltage	$I_{PGOOD} = 5\text{mA}$			0.15	0.4	V

**Note 1:** Stresses beyond those listed under Absolute Maximum Ratings may cause permanent damage to the device. Exposure to any Absolute Maximum Rating condition for extended periods may affect device reliability and lifetime.

**Note 2:** The LTM4606E is guaranteed to meet performance specifications over the  $0^\circ\text{C}$  to  $125^\circ\text{C}$  internal operating temperature range. Specifications over the  $-40^\circ\text{C}$  to  $125^\circ\text{C}$  internal operating temperature range are assured by design, characterization and correlation with statistical process controls. The LTM4606I is guaranteed to meet specifications over the

$-40^\circ\text{C}$  to  $125^\circ\text{C}$  internal operating temperature range. The LTM4606MP is guaranteed and tested over the  $-55^\circ\text{C}$  to  $125^\circ\text{C}$  internal operating temperature range. Note that the maximum ambient temperature consistent with these specifications is determined by specific operating conditions in conjunction with board layout, the rated package thermal resistance and other environmental factors.

**Note 3:** 100% tested at die level only.

**Note 4:** See output current derating curves for different  $V_{IN}$ ,  $V_{OUT}$  and  $T_A$ .

# TYPICAL PERFORMANCE CHARACTERISTICS

**Efficiency vs Load Current with 5V<sub>IN</sub> (FCB = 0)**

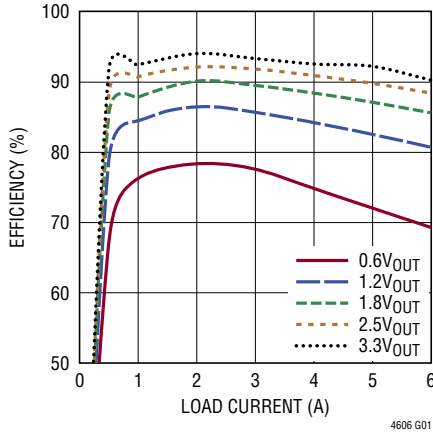

**Efficiency vs Load Current with 12V<sub>IN</sub> (FCB = 0)**

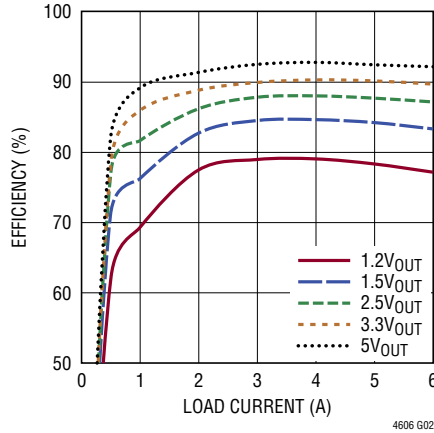

**Efficiency vs Load Current with 24V<sub>IN</sub> (FCB = 0)**

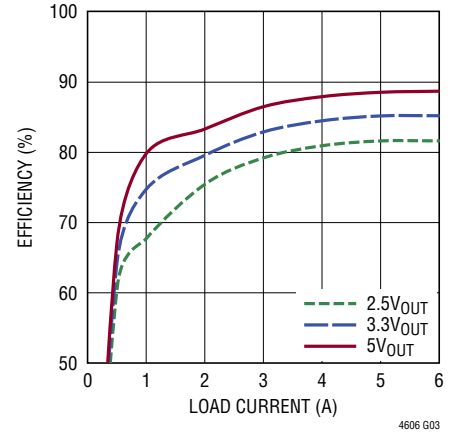

**1.2V Transient Response**

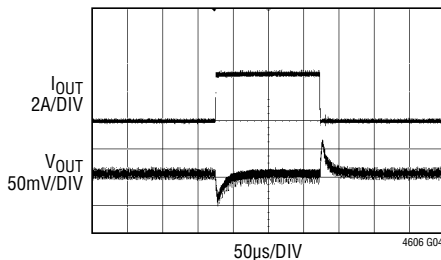

1.2V AT 3.5A/ $\mu$ s LOAD STEP  
 $C_{OUT} = 2 \times 22\mu\text{F}, 10\text{V CERAMIC}$   
 $1 \times 100\mu\text{F}, 6.3\text{V CERAMIC}$

**1.5V Transient Response**

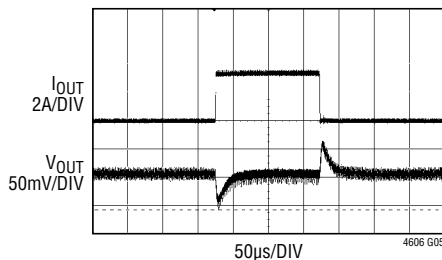

1.5V AT 3.5A/ $\mu$ s LOAD STEP  
 $C_{OUT} = 2 \times 22\mu\text{F}, 10\text{V CERAMIC}$   
 $1 \times 100\mu\text{F}, 6.3\text{V CERAMIC}$

**1.8V Transient Response**

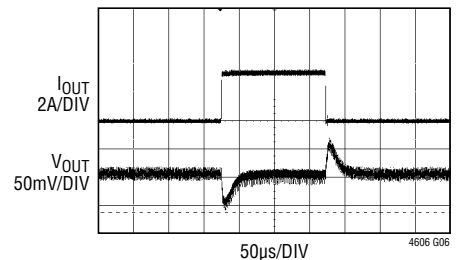

1.8V AT 3.5A/ $\mu$ s LOAD STEP  
 $C_{OUT} = 2 \times 22\mu\text{F}, 10\text{V CERAMIC}$   
 $1 \times 100\mu\text{F}, 6.3\text{V CERAMIC}$

**2.5V Transient Response**

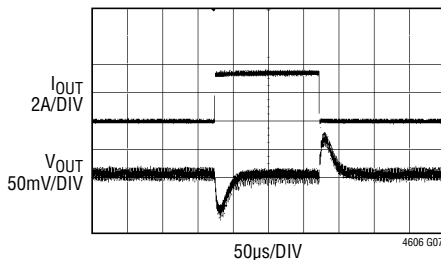

2.5V AT 3.5A/ $\mu$ s LOAD STEP  
 $C_{OUT} = 2 \times 22\mu\text{F}, 10\text{V CERAMIC}$   
 $1 \times 100\mu\text{F}, 6.3\text{V CERAMIC}$

**3.3V Transient Response**

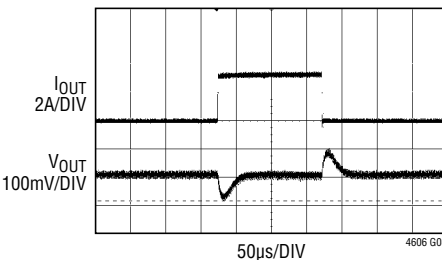

3.3V AT 3.5A/ $\mu$ s LOAD STEP  
 $C_{OUT} = 2 \times 22\mu\text{F}, 10\text{V CERAMIC}$   
 $1 \times 100\mu\text{F}, 6.3\text{V CERAMIC}$

**-55°C, Start-Up, I<sub>OUT</sub> = 0A**

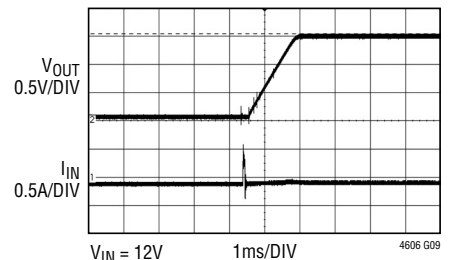

$V_{IN} = 12\text{V}$   
 $V_{OUT} = 1.5\text{V}$   
 $C_{OUT} = 2 \times 22\mu\text{F}, 10\text{V CERAMIC}$   
 $1 \times 100\mu\text{F}, 6.3\text{V CERAMIC}$   
 SOFT-START = 3.9nF

## TYPICAL PERFORMANCE CHARACTERISTICS

**-55°C, Start-Up,  $I_{OUT} = 6A$**

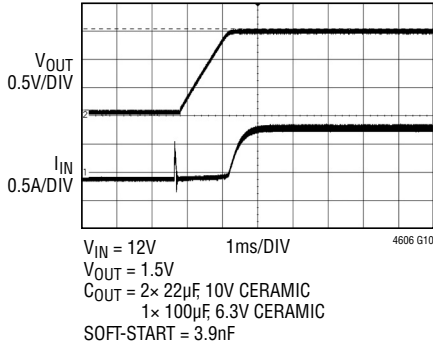

**Start-Up,  $I_{OUT} = 0A$**

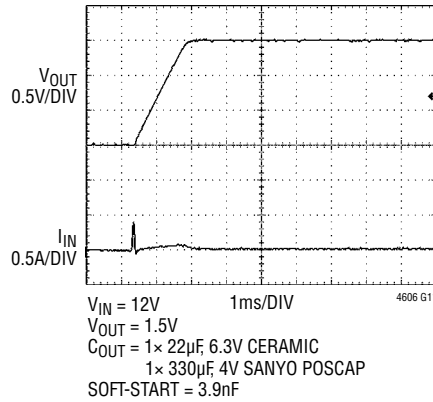

**Start-Up,  $I_{OUT} = 6A$   
(Resistive Load)**

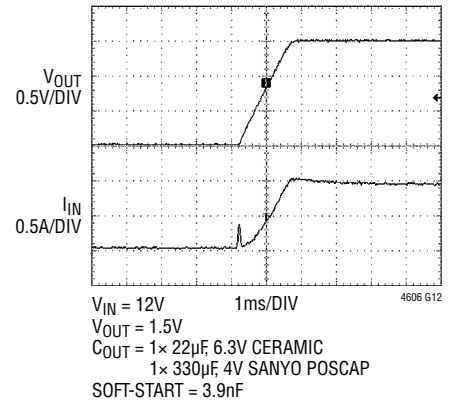

**Start Into Pre-Biased Output**

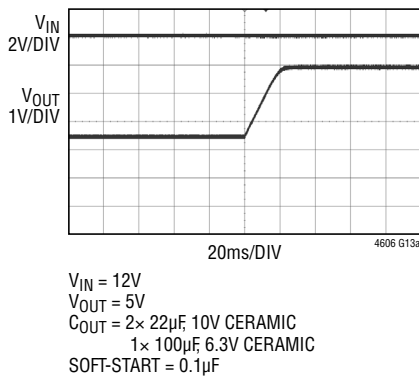

**Short-Circuit Protection,  
 $I_{OUT} = 0A$**

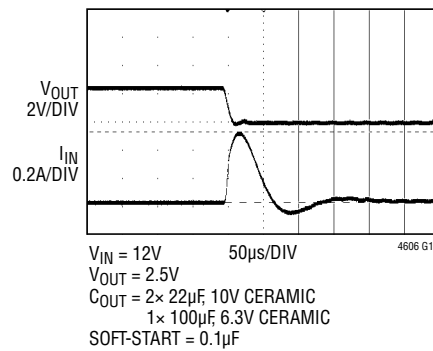

**Short-Circuit Protection,  
 $I_{OUT} = 6A$**

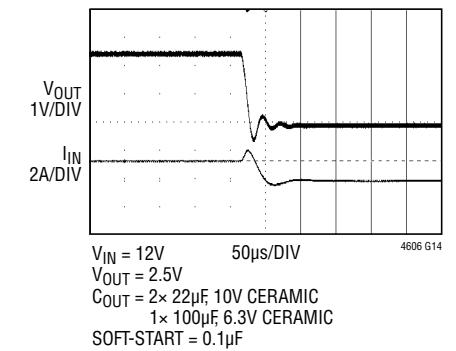

**$V_{IN}$  to  $V_{OUT}$  Step-Down  
Operation Region**

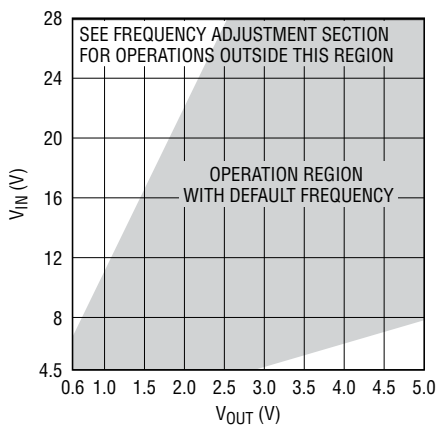

**$V_{FB}$  vs Temperature**

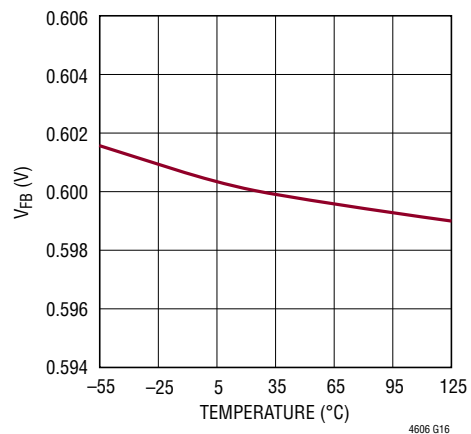

## TYPICAL PERFORMANCE CHARACTERISTICS

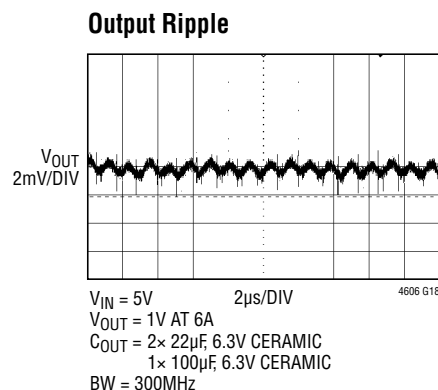
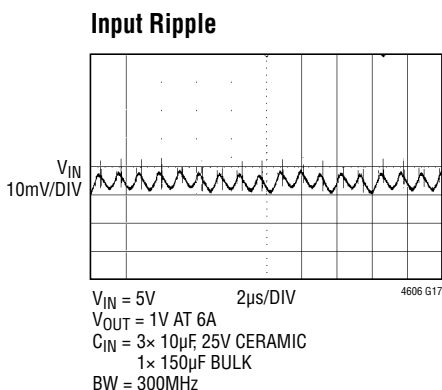

## PIN FUNCTIONS



PACKAGE ROW AND COLUMN LABELING MAY VARY AMONG  $\mu$ Module PRODUCTS. REVIEW EACH PACKAGE LAYOUT CAREFULLY.

**$V_{IN}$  (Bank 1):** Power Input Pins. Apply input voltage between these pins and PGND pins. Recommend placing input decoupling capacitance directly between  $V_{IN}$  pins and PGND pins.

**$V_{OUT}$  (Bank 3):** Power Output Pins. Apply output load between these pins and PGND pins. Recommend placing output decoupling capacitance directly between these pins and PGND pins (see Figure 17).

**PGND (Bank 2):** Power Ground Pins for Both Input and Output Returns.

**$V_D$  (Pins B7, C7):** Top FET Drain Pins. Add more capacitors between  $V_D$  and ground to handle the input RMS current and reduce the input ripple further.

**DRV<sub>CC</sub> (Pins C10, E11, E12):** These pins normally connect to INTV<sub>CC</sub> for powering the internal MOSFET drivers. They can be biased up to 6V from an external supply with about 50mA capability, or an external circuit as shown in Figure 18. This improves efficiency at the higher input voltages by reducing power dissipation in the module.

**INTV<sub>CC</sub> (Pin A7):** This pin is for additional decoupling of the 5V internal regulator.

**PLLIN (Pin A8):** External Clock Synchronization Input to the Phase Detector. This pin is internally terminated to SGND with a 50k resistor. Apply a clock with high level above 2V and below INTV<sub>CC</sub>. See the Applications Information section.

**FCB (Pin M12):** Forced Continuous Input. Connect this pin to SGND to force continuous synchronization operation at low load, to INTV<sub>CC</sub> to enable discontinuous mode operation at low load or to a resistive divider from a secondary output when using a secondary winding.

**TRACK/SS (Pin A9):** Output Voltage Tracking and Soft-Start Pin. When the module is configured as a master output, then a soft-start capacitor is placed on this pin to ground to control the master ramp rate. A soft-start capacitor can be used for soft-start turn-on in a stand-alone regulator. Slave operation is performed by putting a resistor divider from the master output to ground, and connecting the center point of the divider to this pin. See the Applications Information section.

**MPGM (Pins A12, B11):** Programmable Margining Input. A resistor from these pins to ground sets a current that is equal to  $1.18V/R$ . This current multiplied by  $10k\Omega$  will equal a value in millivolts that is a percentage of the 0.6V reference voltage. See the Applications Information section. To parallel LTM4606s, each requires an individual MPGM resistor. Do not tie MPGM pins together.

## PIN FUNCTIONS

**f<sub>SET</sub> (Pin B12):** Frequency set internally to 800kHz in continuous conducting mode at light load. An external resistor can be placed from this pin to ground to increase frequency. See the Applications Information section for frequency adjustment.

**V<sub>FB</sub> (Pin F12):** The Negative Input of the Error Amplifier. Internally, this pin is connected to V<sub>OUT</sub> with a 60.4k precision resistor. Different output voltages can be programmed with an additional resistor between the V<sub>FB</sub> and SGND pins. See the Applications Information section.

**MARG0 (Pin C12):** LSB Logic Input for the Margining Function. Together with the MARG1 pin, the MARG0 pin will determine if a margin high, margin low, or no margin state is applied. The pin has an internal pull-down resistor of 50k. See the Applications Information section.

**MARG1 (Pins C11, D12):** MSB Logic Input for the Margining Function. Together with the MARG0 pin, the MARG1 pins will determine if a margin high, margin low, or no margin state is applied. The pins have an internal pull-down resistor of 50k. See the Applications Information section.

**SGND (Pins D9, H12):** Signal Ground Pins. These pins connect to PGND at output capacitor point. See Figure 17.

**COMP (Pins A11, D11):** Current Control Threshold and Error Amplifier Compensation Point. The current comparator threshold increases with this control voltage. The voltage ranges from 0V to 2.4V with 0.7V corresponding to zero sense voltage (zero current).

**PGOOD (Pin G12):** Output Voltage Power Good Indicator. Open-drain logic output that is pulled to ground when the output voltage is not within  $\pm 10\%$  of the regulation point, after a 25 $\mu$ s power bad mask timer expires.

**RUN (Pins A10, B9):** Run Control Pins. A voltage above 1.9V will turn on the module, and below 1V will turn off the module. A programmable UVLO function can be accomplished with a resistor divider from V<sub>IN</sub> to ground. See Figure 1. This pin has a 5.1V Zener to ground. Maximum pin voltage is 5V. Limit current into the RUN pin to less than 1mA.

**NC (Pins J12, K12, L12):** These pads must be left floating (electrical open circuit) and are used for enhanced solder joint strength.



# BLOCK DIAGRAM

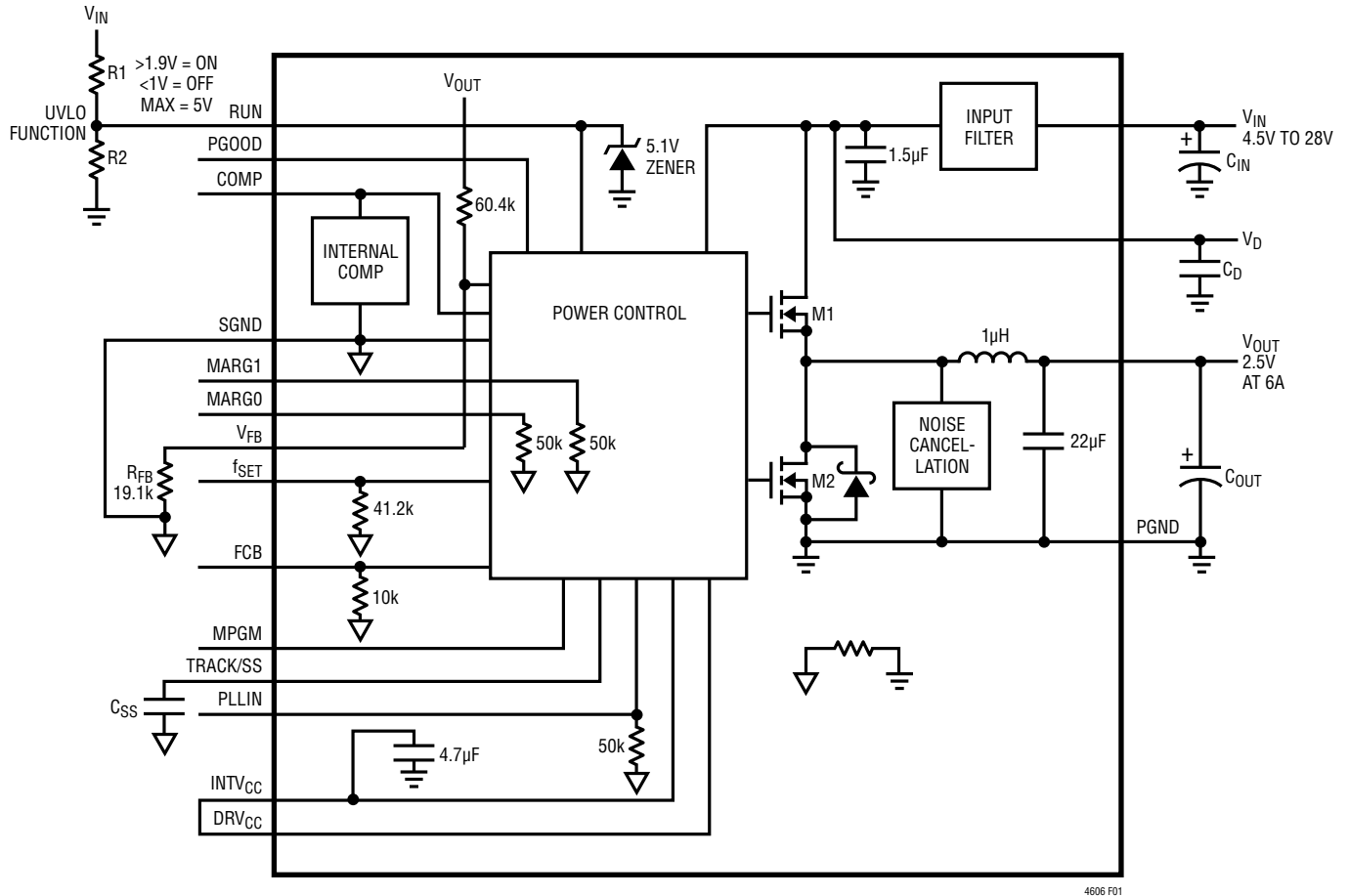

Figure 1. Simplified Block Diagram

## DECOUPLING REQUIREMENTS

T<sub>A</sub> = 25°C. Use Figure 1 configuration.

SYMBOL	PARAMETER	CONDITIONS	MIN	TYP	MAX	UNITS
C <sub>IN</sub>	External Input Capacitor Requirement (V <sub>IN</sub> = 4.5V to 28V, V <sub>OUT</sub> = 2.5V)	I <sub>OUT</sub> = 6A	10			µF
C <sub>OUT</sub>	External Output Capacitor Requirement (V <sub>IN</sub> = 4.5V to 28V, V <sub>OUT</sub> = 2.5V)	I <sub>OUT</sub> = 6A	100	200		µF

## OPERATION

### Power Module Description

The LTM4606 is a standalone non-isolated switching mode DC/DC power supply. It can deliver up to 6A of DC output current with some external input and output capacitors. This module provides precisely regulated output voltage programmable via one external resistor from  $0.6V_{DC}$  to  $5.0V_{DC}$  over a 4.5V to 28V input voltage range. The typical application schematic is shown in Figure 20.

The LTM4606 has an integrated constant on-time current mode regulator, ultralow  $R_{DS(ON)}$  FETs with fast switching speed and integrated Schottky diodes. With current mode control and internal feedback loop compensation, the LTM4606 module has sufficient stability margins and good transient performance under a wide range of operating conditions and with a wide range of output capacitors, even all ceramic output capacitors.

Current mode control provides cycle-by-cycle fast current limiting. Besides, foldback current limiting is provided in an overcurrent condition while  $V_{FB}$  drops. Internal overvoltage and undervoltage comparators pull the open-drain PGOOD output low if the output feedback voltage exits a  $\pm 10\%$  window around the regulation point. Furthermore, in an overvoltage condition, internal top FET M1 is turned off and bottom FET M2 is turned on and held on until the overvoltage condition clears.

Input filter and noise cancellation circuits reduce the noise coupling to I/O sides, and ensure the electromagnetic interference (EMI) to meet EN55022 Class B limits.

Pulling the RUN pin below 1V forces the controller into its shutdown state, turning off both M1 and M2. At low load currents, discontinuous mode (DCM) operation can be enabled to achieve higher efficiency compared to continuous mode (CCM) by setting the FCB pin higher than 0.6V.

When the  $DRV_{CC}$  pin is connected to  $INTV_{CC}$  an integrated 5V linear regulator powers the internal gate drivers. If a 5V external bias supply is applied on the  $DRV_{CC}$  pin, then an efficiency improvement will occur due to the reduced power loss in the internal linear regulator. This is especially true at the higher input voltage range.

The MPGM, MARG0 and MARG1 pins are used to support voltage margining, where the percentage of margin is programmed by the MPGM pin, and the MARG0 and MARG1 selected margining. The PLLIN pin provides frequency synchronization of the device to an external clock. The TRACK/SS pin is used for power supply tracking and soft-start programming.

## APPLICATIONS INFORMATION

The typical LTM4606 application circuit is shown in Figure 20. External component selection is primarily determined by the maximum load current and output voltage. Refer to Table 2 for specific external capacitor requirements for a particular application.

### $V_{IN}$ to $V_{OUT}$ Step-Down Ratios

Under the default frequency, there are restrictions in the maximum  $V_{IN}$  and  $V_{OUT}$  step-down ratio that can be achieved for a given input voltage. These constraints are caused by the limitation of the minimum on and off time in the internal switches. Refer to the Frequency Adjustment section to change the switching frequency and get wider input and output ranges. See the Thermal Considerations and Output Current Derating section in this data sheet for the current restrictions.

### Output Voltage Programming and Margining

The PWM controller has an internal 0.6V reference voltage. As shown in the Block Diagram, a 60.4k internal feedback resistor connects the  $V_{OUT}$  and  $V_{FB}$  pins together. Adding a resistor  $R_{FB}$  from the  $V_{FB}$  pin to the SGND pin programs the output voltage:

$$V_{OUT} = 0.6V \frac{60.4k + R_{FB}}{R_{FB}} \text{ or equivalently,}$$

$$R_{FB} = \frac{60.4k}{\frac{V_{OUT}}{0.6V} - 1}$$

**Table 1.  $R_{FB}$  Standard 1% Resistor Values vs  $V_{OUT}$**

$R_{FB}$ (k $\Omega$ )	Open	60.4	40.2	30.1	25.5	19.1	13.3	8.25
$V_{OUT}$ (V)	0.6	1.2	1.5	1.8	2	2.5	3.3	5

The MPGM pin programs a current that when multiplied by an internal 10k resistor sets up the 0.6V reference  $\pm$  offset for margining. A 1.18V reference divided by the

$R_{PGM}$  resistor on the MPGM pin programs the current. Calculate  $V_{OUT(MARGIN)}$ :

$$V_{OUT(MARGIN)} = \frac{\%V_{OUT}}{100} \cdot V_{OUT}$$

where  $\%V_{OUT}$  is the percentage of  $V_{OUT}$  you want to margin, and  $V_{OUT(MARGIN)}$  is the margin quantity in volts:

$$R_{PGM} = \frac{V_{OUT}}{0.6V} \cdot \frac{1.18V}{V_{OUT(MARGIN)}} \cdot 10k$$

where  $R_{PGM}$  is the resistor value to place on the MPGM pin to ground.

The margining voltage,  $V_{OUT(MARGIN)}$ , will be added or subtracted from the nominal output voltage as determined by the state of the MARG0 and MARG1 pins. See the truth table below:

MARG1	MARG0	MODE
LOW	LOW	NO MARGIN
LOW	HIGH	MARGIN UP
HIGH	LOW	MARGIN DOWN
HIGH	HIGH	NO MARGIN

### Input Capacitors and Input EMI Noise Attenuation

The LTM4606 is designed to achieve low input conducted EMI noise due to the fast switching of turn-on and turn-off. In the LTM4606, a high frequency inductor is integrated to the input line for noise attenuation.  $V_D$  and  $V_{IN}$  pins are available for external input capacitors to form a high frequency  $\pi$  filter. As shown in Figure 19, the ceramic capacitor C1 on the  $V_D$  pins is used to handle most of the RMS current into the converter, so careful attention is needed for capacitor C1 selection.

For a buck converter, the switching duty cycle can be estimated as:

$$D = \frac{V_{OUT}}{V_{IN}}$$

## APPLICATIONS INFORMATION

Without considering the inductor ripple current, the RMS current of the input capacitor can be estimated as:

$$I_{\text{CIN(RMS)}} = \frac{I_{\text{OUT(MAX)}}}{\eta} \cdot \sqrt{D \cdot (1-D)}$$

In the above equation,  $\eta$  is the estimated efficiency of the power module. Note the capacitor ripple current ratings are often based on temperature and hours of life. This makes it advisable to properly derate the capacitor, or choose a capacitor rated at a higher temperature than required. Always contact the capacitor manufacturer for derating requirements.

In a typical 6A output application, one or two very low ESR X5R or X7R, 10 $\mu$ F ceramic capacitors are recommended for C1. This decoupling capacitor should be placed directly adjacent to the module  $V_D$  pins in the PCB layout to minimize the trace inductance and high frequency AC noise. Each 10 $\mu$ F ceramic is typically good for 2 to 3 amps of RMS ripple current. Refer to your ceramics capacitor catalog for the RMS current ratings.

To attenuate high frequency noise, extra input capacitors should be connected to the  $V_{\text{IN}}$  pads and placed before the high frequency inductor to form the  $\pi$  filter. One of these low ESR ceramic capacitors is recommended to be placed close to the connection into the system board. A large bulk 100 $\mu$ F capacitor is only needed if the input source impedance is compromised by long inductive leads or traces. Figure 2 shows the radiated EMI test results to

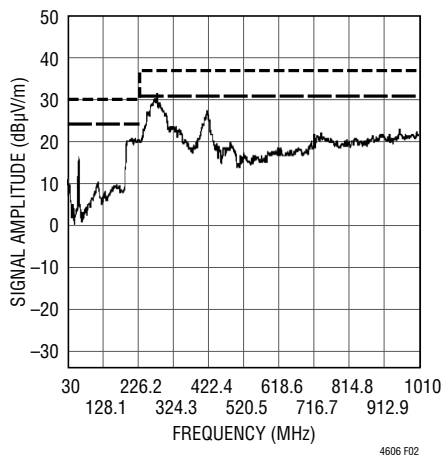

**Figure 2. Radiated Emission Scan with 12V<sub>IN</sub> to 2.5V<sub>OUT</sub> at 6A (1×100 $\mu$ F X7R Ceramic C<sub>OUT</sub>)**

meet EN55022 Class B. For different applications, input capacitance may be varied to meet different radiated EMI limits.

### Output Capacitors

The LTM4606 is designed for low output voltage ripple. The bulk output capacitors defined as C<sub>OUT</sub> are chosen with low enough effective series resistance (ESR) to meet the output voltage ripple and transient requirements. C<sub>OUT</sub> can be a low ESR tantalum capacitor, low ESR polymer capacitor or ceramic capacitor. The typical capacitance is 200 $\mu$ F if all ceramic output capacitors are used. Additional output filtering may be required by the system designer, if further reduction of output ripple or dynamic transient spike is required. Table 2 shows a matrix of different output voltages and output capacitors to minimize the voltage droop and overshoot during a 3A/ $\mu$ s transient. The table optimizes total equivalent ESR and total bulk capacitance to maximize transient performance.

Multiphase operation with multiple LTM4606 devices in parallel will lower the effective output ripple current due to the phase interleaving operation. Refer to Figure 3 for the normalized output ripple current versus the duty cycle. Figure 3 provides a ratio of peak-to-peak output ripple current to the inductor ripple current as functions of duty cycle and the number of paralleled phases. Pick the corresponding duty cycle and the number of phases to get the correct output ripple current value. For example, each phase's inductor ripple current  $D_{\text{Ir}}$  at zero duty cycle is ~2.5A for a 12V to 2.5V design. The duty cycle is about 0.21. The 2-phase curve has a ratio of ~0.58 for a duty cycle of 0.21. This 0.58 ratio of output ripple current to the inductor ripple current  $D_{\text{Ir}}$  at 2.5A equals ~1.5A of the output ripple current ( $\Delta I_L$ ).

The output ripple voltage has two components that are related to the amount of bulk capacitance and effective series resistance (ESR) of the output bulk capacitance. The equation is:

$$\Delta V_{\text{OUT(P-P)}} \approx \left( \frac{\Delta I_L}{8 \cdot f \cdot N \cdot C_{\text{OUT}}} \right) + \text{ESR} \cdot \Delta I_L$$

where  $f$  is the frequency and  $N$  is the number of paralleled phases.

## APPLICATIONS INFORMATION

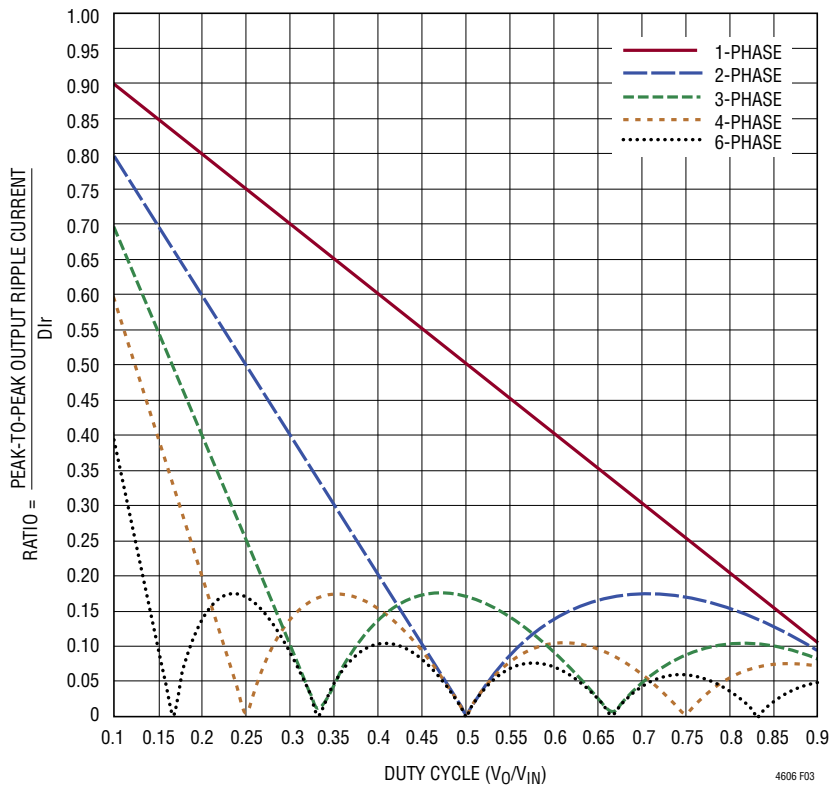

Figure 3. Normalized Output Ripple Current vs Duty Cycle,  $D_{lr} = V_O T / L_I$

### Fault Conditions: Current Limit and Overcurrent Foldback

LTM4606 has a current mode controller, which inherently limits the cycle-by-cycle inductor current not only in steady-state operation, but also in transient.

To further limit current in the event of an overload condition, the LTM4606 provides foldback current limiting. If the output voltage falls by more than 50%, then the maximum output current is progressively lowered to about one sixth of its full current limit value.

### Soft-Start and Tracking

The TRACK/SS pin provides a means to either soft-start the regulator or track it to a different power supply.

A capacitor on this pin will program the ramp rate of the output voltage. A  $1.5\mu\text{A}$  current source will charge up the external soft-start capacitor to 80% of the 0.6V internal voltage reference plus or minus any margin delta. This will control the ramp of the internal reference and the output voltage. The total soft-start time can be calculated as:

$$t_{\text{SOFTSTART}} \cong 0.8 \cdot (0.6\text{V} \pm V_{\text{OUT(MARGIN)}}) \cdot \frac{C_{\text{SS}}}{1.5\mu\text{A}}$$

When the RUN pin falls below 1.5V, then the TRACK/SS pin is reset to allow for proper soft-start control when the regulator is enabled again. Current foldback and forced continuous mode are disabled during the soft-start process. The soft-start function can also be used to control the output ramp up time, so that another regulator can be easily tracked to it.

## APPLICATIONS INFORMATION

### Output Voltage Tracking

Output voltage tracking can be programmed externally using the TRACK/SS pin. The output can be tracked up and down with another regulator. Figure 4 shows an example of coincident tracking where the master regulator's output is divided down with an external resistor divider that is the same as the slave regulator's feedback divider. Ratiometric modes of tracking can be achieved by selecting different resistor values to change the output tracking ratio. The master output must be greater than the slave output for the tracking to work. Figure 5 shows the coincident output tracking characteristics.

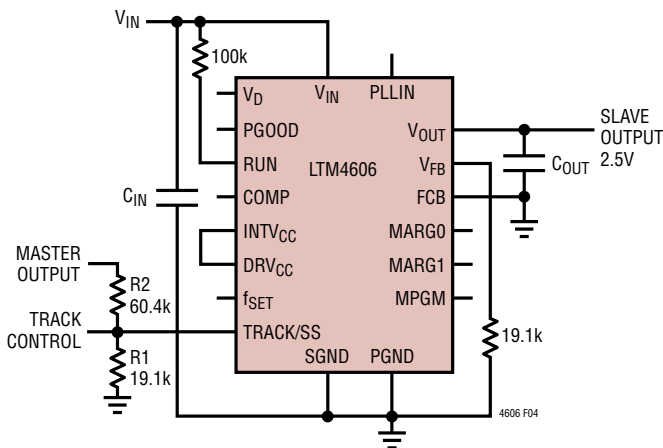

Figure 4. Coincident Tracking Schematic

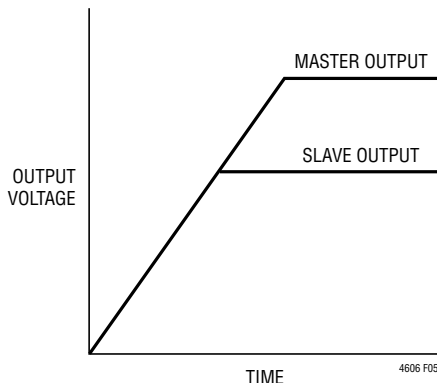

Figure 5. Coincident Output Tracking Characteristics

### Run Enable

The RUN pin is used to enable the power module. The pin has an internal 5.1V Zener to ground. The pin can be driven with a logic input not to exceed 5V.

The RUN pin can also be used as an undervoltage lock out (UVLO) function by connecting a resistor divider from the input supply to the RUN pin:

$$V_{UVLO} = \frac{R1+R2}{R2} \cdot 1.5V$$

See Figure 1, Simplified Block Diagram.

### Power Good

The PGOOD pin is an open-drain pin that can be used to monitor valid output voltage regulation. This pin monitors a  $\pm 10\%$  window around the regulation point and tracks with margining.

### COMP Pin

This pin is the external compensation pin. The module has already been internally compensated for most output voltages. Table 2 is provided for most application requirements. [LTpowerCAD®](#) is available for other control loop optimization.

### FCB Pin

The FCB pin determines whether the bottom MOSFET remains on when current reverses in the inductor. Tying this pin above its 0.6V threshold enables discontinuous operation where the bottom MOSFET turns off when inductor current reverses. FCB pin below the 0.6V threshold forces continuous synchronous operation, allowing current to reverse at light loads and maintain low output ripple.

## APPLICATIONS INFORMATION

### PLLIN

The power module has a phase-locked loop comprised of an internal voltage controlled oscillator and a phase detector. This allows the internal top MOSFET turn-on to be locked to the rising edge of the external clock. The frequency range is  $\pm 30\%$  around the operating frequency. A pulse detection circuit is used to detect a clock on the PLLIN pin to turn on the phase lock loop. The pulse width of the clock has to be at least 400ns and the amplitude at least 2V. The PLLIN pin must be driven from a low impedance source such as a logic gate located close to the pin. During the start-up of the regulator, the phase-locked loop function is disabled.

### INTV<sub>CC</sub> and DRV<sub>CC</sub> Connection

An internal low dropout regulator produces an internal 5V supply that powers the control circuitry and DRV<sub>CC</sub> for driving the internal power MOSFETs. Therefore, if the system does not have a 5V power rail, the LTM4606 can be directly powered by V<sub>IN</sub>. The gate driver current through the LDO is about 20mA. The internal LDO power dissipation can be calculated as:

$$P_{LDO\_LOSS} = 20\text{mA} \cdot (V_{IN} - 5\text{V})$$

The LTM4606 also provides an external gate driver voltage pin DRV<sub>CC</sub>. If there is a 5V rail in the system, it is recommended to connect DRV<sub>CC</sub> pin to the external 5V rail. This is especially true for higher input voltages. Do not apply more than 6V to the DRV<sub>CC</sub> pin. A 5V output can be used to power the DRV<sub>CC</sub> pin with an external circuit as shown in Figure 18.

### Parallel Operation of the Module

The LTM4606 device is an inherently current mode controlled device. Parallel modules will have very good current sharing. This will balance the thermals on the design. The voltage feedback equation changes with the variable N as modules are paralleled:

$$V_{OUT} = 0.6\text{V} \frac{\frac{60.4\text{k}}{N} + R_{FB}}{R_{FB}}$$

N is the number of paralleled modules.

### Thermal Considerations and Output Current Derating

In different applications, LTM4606 operates in a variety of thermal environments. The maximum output current is limited by the environment thermal condition. Sufficient cooling should be provided to help ensure reliable operation. When the cooling is limited, proper output current derating is necessary, considering ambient temperature, airflow, input/output condition, and the need for increased reliability.

The power loss curves in Figures 6 and 7 can be used in coordination with the load current derating curves in Figures 8 to 15 for calculating an approximate  $\theta_{JA}$  for the module. The graphs delineate between no heat sink, and a BGA heat sink. Each of the load current derating curves will lower the maximum load current as a function of the increased ambient temperature to keep the maximum junction temperature of the power module at 125°C maximum. Each of the derating curves and the power loss curve that corresponds to the correct output voltage can be used to solve for the approximate  $\theta_{JA}$  of the condition. Each figure has three curves that are taken at three different air flow conditions. Table 3 and Table 4 provide the approximate  $\theta_{JA}$  for Figures 8 to 15. A complete explanation of the thermal characteristics is provided in the thermal [Application Note AN110](#).

### Safety Considerations

The LTM4606 modules do not provide galvanic isolation from V<sub>IN</sub> to V<sub>OUT</sub>. There is no internal fuse. If required, a slow blow fuse with a rating twice the maximum input current needs to be provided to protect each unit from catastrophic failure.

### Radiated EMI Noise

High radiated EMI noise is a disadvantage for switching regulators by nature. Fast switching turn-on and turn-off make large di/dt change in the converters, which act as the radiation sources in most systems. The LTM4606 integrates the feature to minimize the radiated EMI noise for applications with low noise requirements. Optimized gate driver for the MOSFET and noise cancellation network are installed inside the LTM4606 to achieve low radiated EMI noise. Figure 16 shows a typical example for LTM4606 to meet the Class B of EN55022 radiated emission limit.



APPLICATIONS INFORMATION

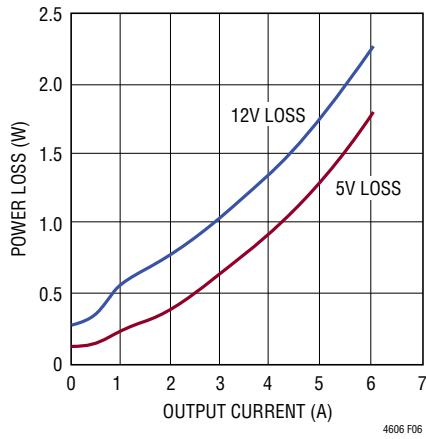

Figure 6. 1.5V Power Loss

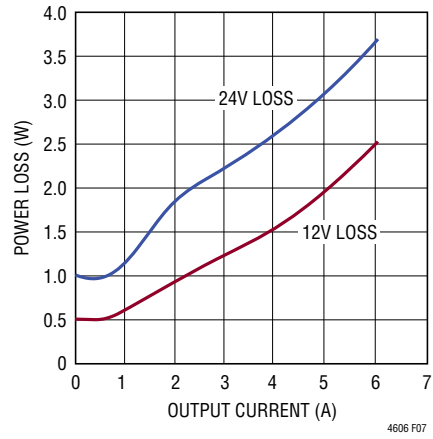

Figure 7. 3.3V Power Loss

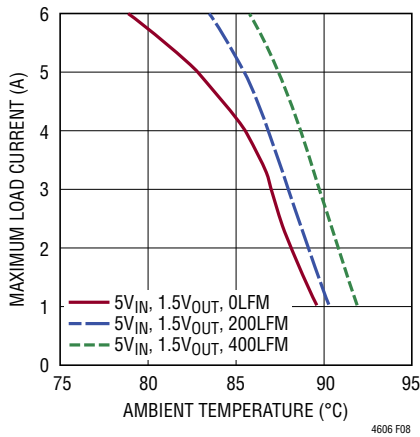

Figure 8. No Heat Sink

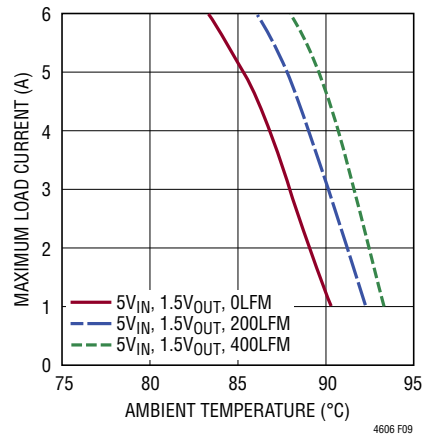

Figure 9. BGA Heat Sink

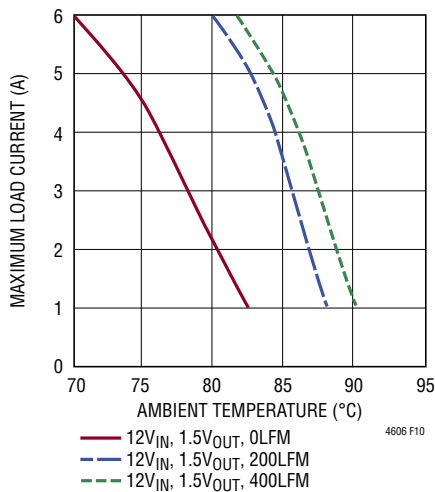

Figure 10. No Heat Sink

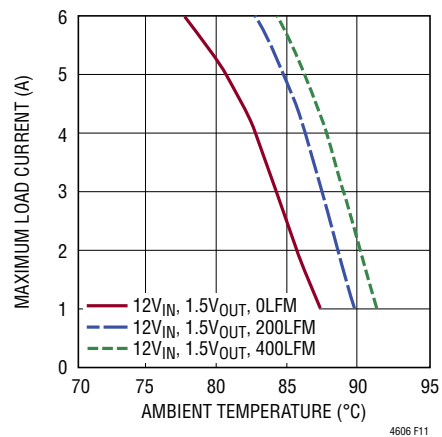

Figure 11. BGA Heat Sink



# APPLICATIONS INFORMATION

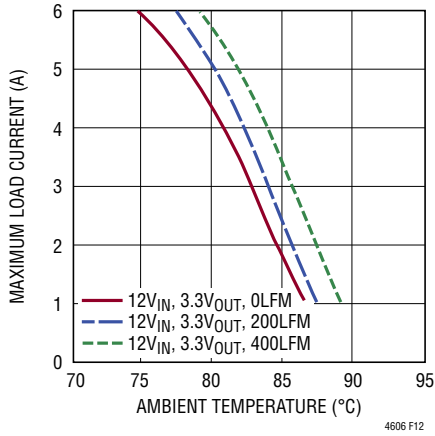

Figure 12. No Heat Sink

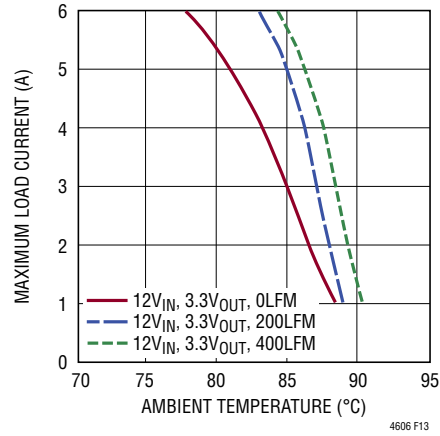

Figure 13. BGA Heat Sink

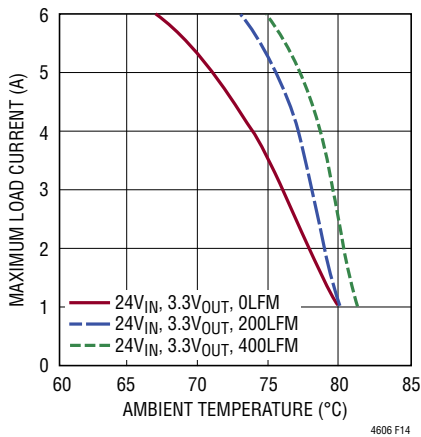

Figure 14. No Heat Sink

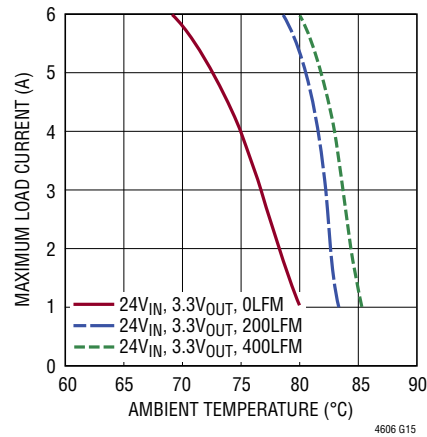

Figure 15. BGA Heat Sink

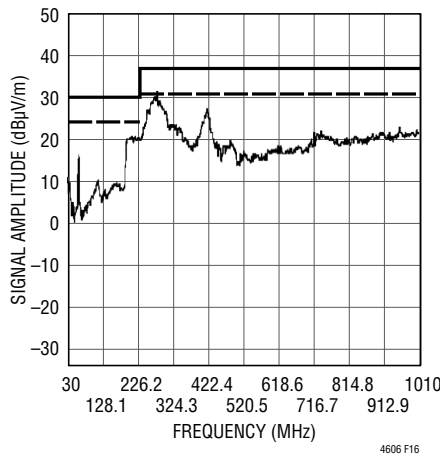

Figure 16. Radiated Emission Scan with 12V<sub>IN</sub> to 2.5V<sub>OUT</sub> at 6A (1×100µF X7R Ceramic C<sub>OUT</sub>)

## APPLICATIONS INFORMATION

Table 2. Output Voltage Response vs Component Matrix (Refer to Figure 20)

TYPICAL MEASURED VALUES										
C <sub>OUT1</sub> VENDORS		PART NUMBER			C <sub>OUT2</sub> VENDORS		PART NUMBER			
TAIYO YUDEN		JMK316BJ226ML-T501 (22 $\mu$ F, 6.3V)			SANYO POSCAP		6TPE220MIL (220 $\mu$ F, 6.3V)			
TAIYO YUDEN		JMK325BJ476MM-T (47 $\mu$ F, 6.3V)			SANYO POSCAP		2R5TPE330M9 (330 $\mu$ F, 2.5V)			
TDK		C3225X5R0J476M (47 $\mu$ F, 6.3V)			SANYO POSCAP		4TPE330MCL (330 $\mu$ F, 4V)			

V <sub>OUT</sub> (V)	C <sub>IN</sub> (CERAMIC)	C <sub>IN</sub> (BULK)	C <sub>OUT1</sub> (CERAMIC)	C <sub>OUT2</sub> (BULK)	V <sub>IN</sub> (V)	DROOP (mV)	PEAK TO PEAK (mV)	RECOVERY TIME ( $\mu$ s)	LOAD STEP (A/ $\mu$ s)	R <sub>FB</sub> (k $\Omega$ )
1.2	2 $\times$ 10 $\mu$ F 35V	150 $\mu$ F 35V	1 $\times$ 22 $\mu$ F 6.3V	330 $\mu$ F 4V	5	34	68	30	3	60.4
1.2	2 $\times$ 10 $\mu$ F 35V	150 $\mu$ F 35V	1 $\times$ 47 $\mu$ F 6.3V	330 $\mu$ F 2.5V	5	22	40	26	3	60.4
1.2	2 $\times$ 10 $\mu$ F 35V	150 $\mu$ F 35V	2 $\times$ 47 $\mu$ F 6.3V	220 $\mu$ F 6.3V	5	20	40	24	3	60.4
1.2	2 $\times$ 10 $\mu$ F 35V	150 $\mu$ F 35V	4 $\times$ 47 $\mu$ F 6.3V	NONE	5	32	60	18	3	60.4
1.2	2 $\times$ 10 $\mu$ F 35V	150 $\mu$ F 35V	1 $\times$ 22 $\mu$ F 6.3V	330 $\mu$ F 4V	12	34	68	30	3	60.4
1.2	2 $\times$ 10 $\mu$ F 35V	150 $\mu$ F 35V	1 $\times$ 47 $\mu$ F 6.3V	330 $\mu$ F 2.5V	12	22	40	26	3	60.4
1.2	2 $\times$ 10 $\mu$ F 35V	150 $\mu$ F 35V	2 $\times$ 47 $\mu$ F 6.3V	220 $\mu$ F 6.3V	12	20	39	24	3	60.4
1.2	2 $\times$ 10 $\mu$ F 35V	150 $\mu$ F 35V	4 $\times$ 47 $\mu$ F 6.3V	NONE	12	29.5	55	18	3	60.4
1.5	2 $\times$ 10 $\mu$ F 35V	150 $\mu$ F 35V	1 $\times$ 22 $\mu$ F 6.3V	330 $\mu$ F 4V	5	35	70	30	3	40.2
1.5	2 $\times$ 10 $\mu$ F 35V	150 $\mu$ F 35V	1 $\times$ 47 $\mu$ F 6.3V	330 $\mu$ F 2.5V	5	25	48	30	3	40.2
1.5	2 $\times$ 10 $\mu$ F 35V	150 $\mu$ F 35V	2 $\times$ 47 $\mu$ F 6.3V	220 $\mu$ F 6.3V	5	24	47.5	26	3	40.2
1.5	2 $\times$ 10 $\mu$ F 35V	150 $\mu$ F 35V	4 $\times$ 47 $\mu$ F 6.3V	NONE	5	36	68	26	3	40.2
1.5	2 $\times$ 10 $\mu$ F 35V	150 $\mu$ F 35V	1 $\times$ 22 $\mu$ F 6.3V	330 $\mu$ F 4V	12	35	70	30	3	40.2
1.5	2 $\times$ 10 $\mu$ F 35V	150 $\mu$ F 35V	1 $\times$ 47 $\mu$ F 6.3V	330 $\mu$ F 2.5V	12	25	48	30	3	40.2
1.5	2 $\times$ 10 $\mu$ F 35V	150 $\mu$ F 35V	2 $\times$ 47 $\mu$ F 6.3V	220 $\mu$ F 6.3V	12	24	45	26	3	40.2
1.5	2 $\times$ 10 $\mu$ F 35V	150 $\mu$ F 35V	4 $\times$ 47 $\mu$ F 6.3V	NONE	12	32.6	61.9	26	3	40.2
1.8	2 $\times$ 10 $\mu$ F 35V	150 $\mu$ F 35V	1 $\times$ 22 $\mu$ F 6.3V	330 $\mu$ F 4V	5	38	76	37	3	30.1
1.8	2 $\times$ 10 $\mu$ F 35V	150 $\mu$ F 35V	1 $\times$ 47 $\mu$ F 6.3V	330 $\mu$ F 2.5V	5	29.5	57.5	30	3	30.1
1.8	2 $\times$ 10 $\mu$ F 35V	150 $\mu$ F 35V	2 $\times$ 47 $\mu$ F 6.3V	220 $\mu$ F 6.3V	5	28	55	26	3	30.1
1.8	2 $\times$ 10 $\mu$ F 35V	150 $\mu$ F 35V	4 $\times$ 47 $\mu$ F 6.3V	NONE	5	43	80	26	3	30.1
1.8	2 $\times$ 10 $\mu$ F 35V	150 $\mu$ F 35V	1 $\times$ 22 $\mu$ F 6.3V	330 $\mu$ F 4V	12	38	76	37	3	30.1
1.8	2 $\times$ 10 $\mu$ F 35V	150 $\mu$ F 35V	1 $\times$ 47 $\mu$ F 6.3V	330 $\mu$ F 2.5V	12	28	55	30	3	30.1
1.8	2 $\times$ 10 $\mu$ F 35V	150 $\mu$ F 35V	2 $\times$ 47 $\mu$ F 6.3V	220 $\mu$ F 6.3V	12	27	52	26	3	30.1
1.8	2 $\times$ 10 $\mu$ F 35V	150 $\mu$ F 35V	4 $\times$ 47 $\mu$ F 6.3V	NONE	12	36.4	70	26	3	30.1
2.5	2 $\times$ 10 $\mu$ F 35V	150 $\mu$ F 35V	1 $\times$ 22 $\mu$ F 6.3V	330 $\mu$ F 4V	5	38	78	40	3	19.1
2.5	2 $\times$ 10 $\mu$ F 35V	150 $\mu$ F 35V	1 $\times$ 47 $\mu$ F 6.3V	330 $\mu$ F 4V	5	37.6	74	34	3	19.1
2.5	2 $\times$ 10 $\mu$ F 35V	150 $\mu$ F 35V	2 $\times$ 47 $\mu$ F 6.3V	220 $\mu$ F 6.3V	5	39.5	78.1	28	3	19.1
2.5	2 $\times$ 10 $\mu$ F 35V	150 $\mu$ F 35V	4 $\times$ 47 $\mu$ F 6.3V	NONE	5	66	119	12	3	19.1
2.5	2 $\times$ 10 $\mu$ F 35V	150 $\mu$ F 35V	1 $\times$ 22 $\mu$ F 6.3V	330 $\mu$ F 4V	12	38	78	40	3	19.1
2.5	2 $\times$ 10 $\mu$ F 35V	150 $\mu$ F 35V	1 $\times$ 47 $\mu$ F 6.3V	330 $\mu$ F 4V	12	34.5	66.3	34	3	19.1
2.5	2 $\times$ 10 $\mu$ F 35V	150 $\mu$ F 35V	2 $\times$ 47 $\mu$ F 6.3V	220 $\mu$ F 6.3V	12	35.8	68.8	28	3	19.1
2.5	2 $\times$ 10 $\mu$ F 35V	150 $\mu$ F 35V	4 $\times$ 47 $\mu$ F 6.3V	NONE	12	50	98	18	3	19.1
3.3	2 $\times$ 10 $\mu$ F 35V	150 $\mu$ F 35V	1 $\times$ 22 $\mu$ F 6.3V	330 $\mu$ F 4V	7	42	86	40	3	13.3
3.3	2 $\times$ 10 $\mu$ F 35V	150 $\mu$ F 35V	1 $\times$ 47 $\mu$ F 6.3V	330 $\mu$ F 4V	7	47	89	32	3	13.3
3.3	2 $\times$ 10 $\mu$ F 35V	150 $\mu$ F 35V	2 $\times$ 47 $\mu$ F 6.3V	220 $\mu$ F 6.3V	7	50	94	28	3	13.3
3.3	2 $\times$ 10 $\mu$ F 35V	150 $\mu$ F 35V	4 $\times$ 47 $\mu$ F 6.3V	NONE	7	75	141	14	3	13.3
3.3	2 $\times$ 10 $\mu$ F 35V	150 $\mu$ F 35V	1 $\times$ 22 $\mu$ F 6.3V	330 $\mu$ F 4V	12	42	86	40	3	13.3
3.3	2 $\times$ 10 $\mu$ F 35V	150 $\mu$ F 35V	1 $\times$ 47 $\mu$ F 6.3V	330 $\mu$ F 4V	12	47	88	32	3	13.3
3.3	2 $\times$ 10 $\mu$ F 35V	150 $\mu$ F 35V	2 $\times$ 47 $\mu$ F 6.3V	220 $\mu$ F 6.3V	12	50	94	28	3	13.3
3.3	2 $\times$ 10 $\mu$ F 35V	150 $\mu$ F 35V	4 $\times$ 47 $\mu$ F 6.3V	NONE	12	69	131	22	3	13.3
5	2 $\times$ 10 $\mu$ F 35V	150 $\mu$ F 35V	4 $\times$ 47 $\mu$ F 6.3V	NONE	12	110	215	20	3	8.25
5	2 $\times$ 10 $\mu$ F 35V	150 $\mu$ F 35V	4 $\times$ 47 $\mu$ F 6.3V	NONE	15	110	215	20	3	8.25
5	2 $\times$ 10 $\mu$ F 35V	150 $\mu$ F 35V	4 $\times$ 47 $\mu$ F 6.3V	NONE	20	110	217	20	3	8.25

## APPLICATIONS INFORMATION

**Table 3. 1.5V Output**

DERATING CURVE	V <sub>IN</sub> (V)	POWER LOSS CURVE	AIR FLOW (LFM)	HEAT SINK	θ <sub>JA</sub> (°C/W)
Figure 8, Figure 10	5, 12	Figure 6	0	None	13.5
Figure 8, Figure 10	5, 12	Figure 6	200	None	10
Figure 8, Figure 10	5, 12	Figure 6	400	None	9
Figure 9, Figure 11	5, 12	Figure 6	0	BGA Heat Sink	9.5
Figure 9, Figure 11	5, 12	Figure 6	200	BGA Heat Sink	7
Figure 9, Figure 11	5, 12	Figure 6	400	BGA Heat Sink	5

**Table 4. 3.3V Output**

DERATING CURVE	V <sub>IN</sub> (V)	POWER LOSS CURVE	AIR FLOW (LFM)	HEAT SINK	θ <sub>JA</sub> (°C/W)
Figure 12, Figure 14	12, 24	Figure 7	0	None	13.5
Figure 12, Figure 14	12, 24	Figure 7	200	None	11
Figure 12, Figure 14	12, 24	Figure 7	400	None	10
Figure 13, Figure 15	12, 24	Figure 7	0	BGA Heat Sink	10
Figure 13, Figure 15	12, 24	Figure 7	200	BGA Heat Sink	7
Figure 13, Figure 15	12, 24	Figure 7	400	BGA Heat Sink	5

Heat Sink Manufacturer	PART NUMBER	WEBSITE
AAVID Thermalloy	375424B00034G	www.aavidthermalloy.com
Cool Innovations	4-050503P to 4-050508P	www.coolinnovations.com

### Layout Checklist/Example

The high integration of LTM4606 makes the PCB board layout very simple and easy. However, to optimize its electrical and thermal performance, some layout considerations are still necessary.

- Use large PCB copper areas for high current path, including V<sub>IN</sub>, PGND and V<sub>OUT</sub>. It helps to minimize the PCB conduction loss and thermal stress.
- Place high frequency ceramic input and output capacitors next to the V<sub>D</sub>, PGND and V<sub>OUT</sub> pins to minimize high frequency noise.
- Place a dedicated power ground layer underneath the unit.
- Use round corners for the PCB copper layer to minimize the radiated noise.
- To minimize the EMI noise and reduce module thermal stress, use multiple vias for interconnection between top layer and other power layers on different locations.
- Do not put vias directly on pads, unless they are capped.

- Use a separated SGND ground copper area for components connected to signal pins. Connect the SGND to PGND underneath the unit.
- Place one or more high frequency ceramic capacitors close to the connection into the system board.

Figure 17 gives a good example of the recommended layout.

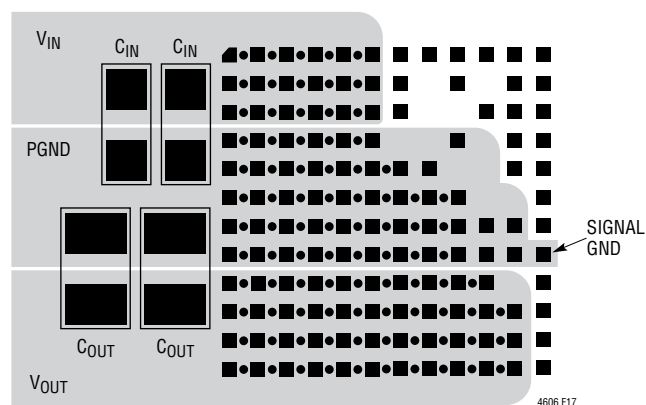

(LGA Shown, for BGA Use Circle Pads)

**Figure 17. Recommended PCB Layout**

## APPLICATIONS INFORMATION

### Frequency Adjustment

The LTM4606 is designed to typically operate at 800kHz across most input conditions. The  $f_{SET}$  pin is typically left open. The switching frequency has been optimized for maintaining constant output ripple noise over most operating ranges. The 800kHz switching frequency and the 400ns minimum off time can limit operation at higher duty cycles like 5V to 3.3V, and produce excessive inductor ripple currents for lower duty cycle applications like 28V to 5V.

### Example for 5V Output

LTM4606 minimum on-time = 100ns  
 $t_{ON} = ((V_{OUT} \cdot 10pF)/I_{fSET})$ , for  $V_{OUT} > 4.8V$  use 4.8V  
 LTM4606 minimum off-time = 400ns  
 $t_{OFF} = t - t_{ON}$ , where  $t = 1/\text{Frequency}$   
 Duty Cycle =  $t_{ON}/t$  or  $V_{OUT}/V_{IN}$

Equations for setting frequency:

$I_{fSET} = (V_{IN}/(3 \cdot R_{fSET}))$ , where the internal  $R_{fSET}$  is 41.2k. For 28V input operation,  $I_{fSET} = 227\mu A$ .  $t_{ON} = ((4.8 \cdot 10pF)/I_{fSET})$ ,  $t_{ON} = 211ns$ . Frequency =  $(V_{OUT}/(V_{IN} \cdot t_{ON})) = (5V/(28 \cdot 211ns)) \sim 850kHz$ . The inductor ripple current begins to get high at the higher input voltages due to a larger voltage across the inductor. The current ripple is  $\sim 5A$  at 20% duty cycle for the integrated 1 $\mu H$  inductor. The inductor ripple current can be lowered at the higher input voltages by adding an external resistor from  $f_{SET}$  to ground to increase the switching frequency. A 4A ripple current is chosen, and the total peak current is equal to 1/2 of the 4A ripple current plus the output current. For 5V output, current is limited to 5A, so the total peak current is less than 7A. This is below the 8A peak specified value. A 150k resistor is placed from  $f_{SET}$  to ground, and the parallel combination of 150k and 41.2k equates to 32.3k. The  $I_{fSET}$  calculation with 32.3k and 28V input voltage equals 289 $\mu A$ . This equates to a  $t_{ON}$  of 166ns. This will increase the switching frequency from 850kHz to  $\sim 1MHz$  for the 28V to 5V conversion. The minimum on time is above 100ns at 28V input. Since the switching frequency is approximately constant over input and output conditions, then the lower input voltage range is limited to 8V for the 1MHz operation due to the 400ns minimum off time. Equation:  $t_{ON} = (V_{OUT}/V_{IN}) \cdot (1/\text{Frequency})$  equates to a 375ns on time, and a 400ns off

time. Figure 18 shows an operating range of 10V to 28V for 1MHz operation with a 150k resistor to ground, and an 8V to 16V operating range for  $f_{SET}$  floating. These modifications are made to provide wider input voltage ranges for the 5V output designs while limiting the inductor ripple current, and maintaining the 400ns minimum off-time.

### Example for 3.3V Output

LTM4606 minimum on-time = 100ns  
 $t_{ON} = ((V_{OUT} \cdot 10pF)/I_{fSET})$   
 LTM4606 minimum off-time = 400ns  
 $t_{OFF} = t - t_{ON}$ , where  $t = 1/\text{Frequency}$   
 Duty Cycle (DC) =  $t_{ON}/t$  or  $V_{OUT}/V_{IN}$

Equations for setting frequency:

$I_{fSET} = (V_{IN}/(3 \cdot R_{fSET}))$ , for 28V input operation,  $I_{fSET} = 227\mu A$ ,  $t_{ON} = ((3.3 \cdot 10pF)/I_{fSET})$ ,  $t_{ON} = 145ns$ , where the internal  $R_{fSET}$  is 41.2k. Frequency =  $(V_{OUT}/(V_{IN} \cdot t_{ON})) = (3.3V/(28 \cdot 145ns)) \sim 810kHz$ . The minimum on-time and minimum-off time are within specification at 146ns and 1089ns. But the 4.5V minimum input for converting 3.3V output will not meet the minimum off-time specification of 400ns.  $t_{ON} = 905ns$ , Frequency = 810kHz,  $t_{OFF} = 329ns$ .

### Solution

Lower the switching frequency at lower input voltages to allow for higher duty cycles, and meet the 400ns minimum off-time at 4.5V input voltage. The off-time should be about 500ns with 100ns guard band. The duty cycle for  $(3.3V/4.5V) = \sim 73\%$ . Frequency =  $(1 - DC)/t_{OFF}$  or  $(1 - 0.73)/500ns = 540kHz$ . The switching frequency needs to be lowered to 540kHz at 4.5V input.  $t_{ON} = DC/\text{frequency}$ , or 1.35 $\mu s$ . The  $f_{SET}$  pin voltage compliance is 1/3 of  $V_{IN}$ , and the  $I_{fSET}$  current equates to 36 $\mu A$  with the internal 41.2k. The  $I_{fSET}$  current needs to be 24 $\mu A$  for 540kHz operation. A resistor can be placed from  $V_{OUT}$  to  $f_{SET}$  to lower the effective  $I_{fSET}$  current out of the  $f_{SET}$  pin to 24 $\mu A$ . The  $f_{SET}$  pin is  $4.5V/3 = 1.5V$  and  $V_{OUT} = 3.3V$ , therefore a 150k resistor will source 12 $\mu A$  into the  $f_{SET}$  node and lower the  $I_{fSET}$  current to 24 $\mu A$ . This enables the 540kHz operation and the 4.5V to 28V input operation for down converting to 3.3V output as shown in Figure 19. The frequency will scale from 540kHz to 950kHz over this input range. This provides for an effective output current of 5A over the input range.



TYPICAL APPLICATIONS

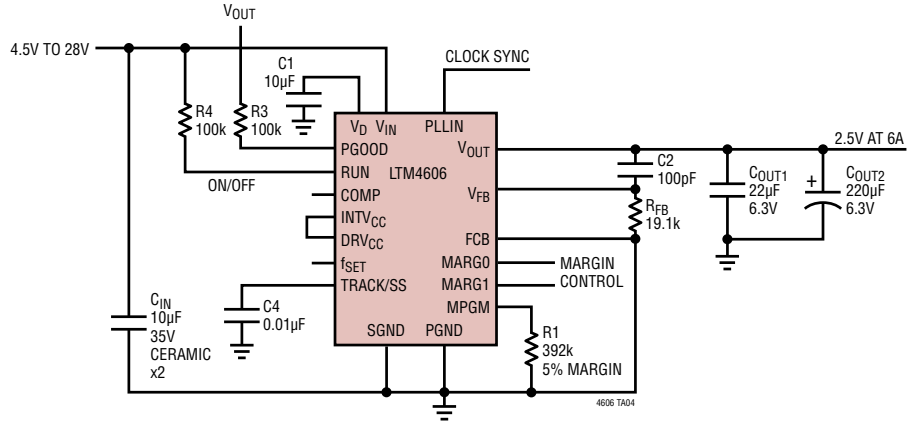

Figure 20. Typical 4.5V to 28V<sub>IN</sub>, 2.5V at 6A Design

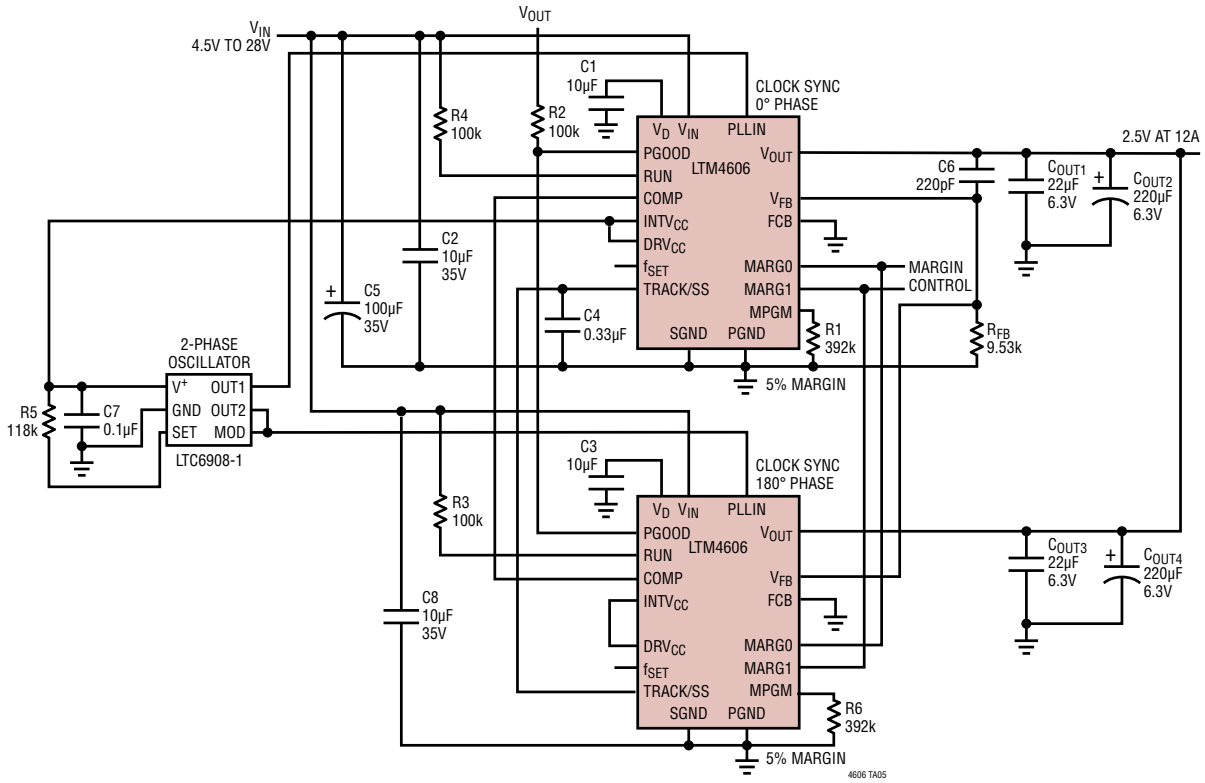

Figure 21. 2-Phase, Parallel 2.5V at 12A Design

## TYPICAL APPLICATIONS

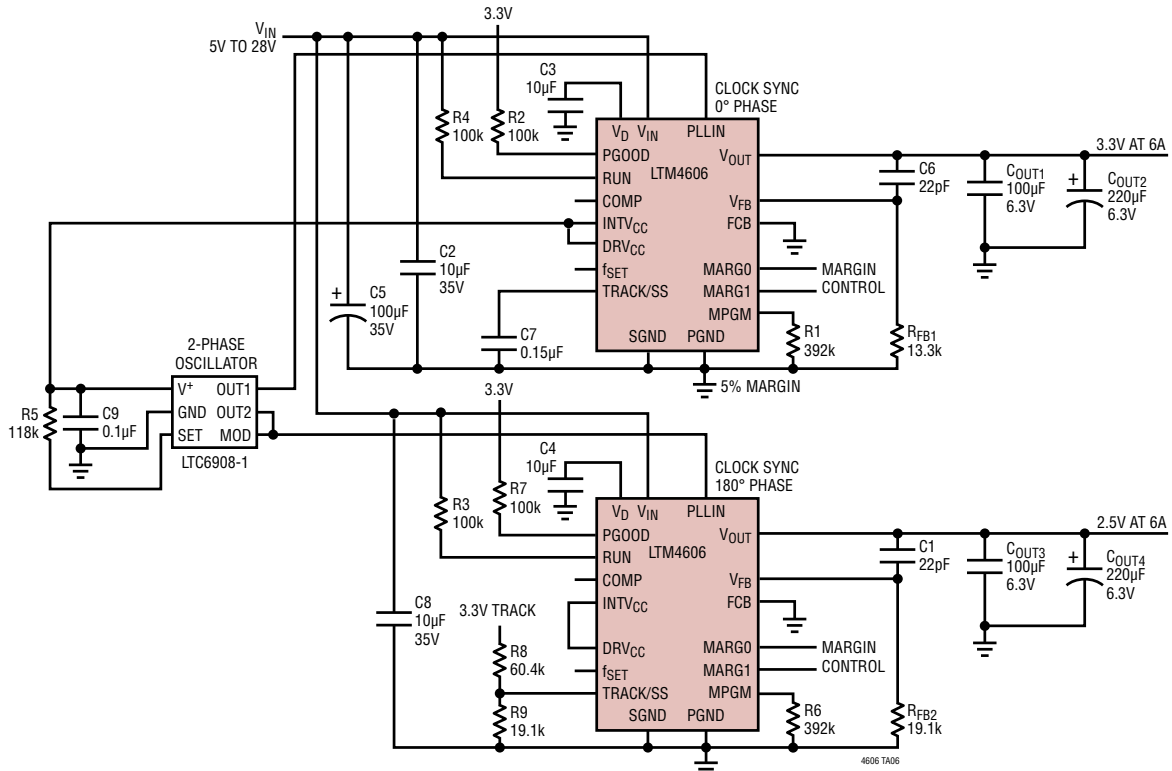

Figure 22. 2-Phase, 3.3V and 2.5V Outputs at 6A with Tracking and Margining

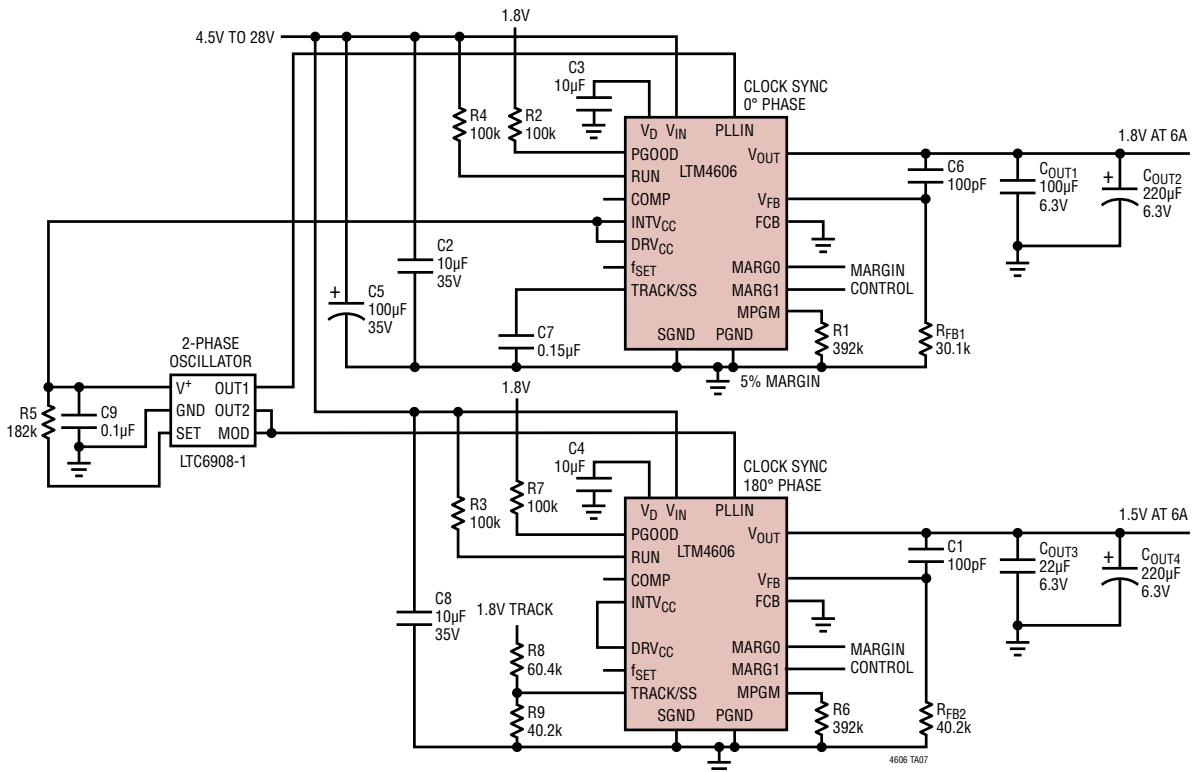

Figure 23. 2-Phase, 1.8V and 1.5V Outputs at 6A with Tracking and Margining

## PACKAGE DESCRIPTION

**Pin Assignment Tables  
(Arranged by Pin Function)**

PIN NAME		PIN NAME		PIN NAME		PIN NAME	
A1	V <sub>IN</sub>	D1	PGND	J1	V <sub>OUT</sub>	A7	INTV <sub>CC</sub>
A2	V <sub>IN</sub>	D2	PGND	J2	V <sub>OUT</sub>	A8	PLLIN
A3	V <sub>IN</sub>	D3	PGND	J3	V <sub>OUT</sub>	A9	TRACK/SS
A4	V <sub>IN</sub>	D4	PGND	J4	V <sub>OUT</sub>	A10	RUN
A5	V <sub>IN</sub>	D5	PGND	J5	V <sub>OUT</sub>	A11	COMP
A6	V <sub>IN</sub>	D6	PGND	J6	V <sub>OUT</sub>	A12	MPGM
B1	V <sub>IN</sub>	E1	PGND	J7	V <sub>OUT</sub>	B7	V <sub>D</sub>
B2	V <sub>IN</sub>	E2	PGND	J8	V <sub>OUT</sub>	B8	-
B3	V <sub>IN</sub>	E3	PGND	J9	V <sub>OUT</sub>	B9	RUN
B4	V <sub>IN</sub>	E4	PGND	J10	V <sub>OUT</sub>	B10	-
B5	V <sub>IN</sub>	E5	PGND	J11	V <sub>OUT</sub>	B11	MPGM
B6	V <sub>IN</sub>	E6	PGND	K1	V <sub>OUT</sub>	B12	f <sub>SET</sub>
C1	V <sub>IN</sub>	E7	PGND	K2	V <sub>OUT</sub>	C7	V <sub>D</sub>
C2	V <sub>IN</sub>	E8	PGND	K3	V <sub>OUT</sub>	C8	-
C3	V <sub>IN</sub>	F1	PGND	K4	V <sub>OUT</sub>	C9	-
C4	V <sub>IN</sub>	F2	PGND	K5	V <sub>OUT</sub>	C10	DRV <sub>CC</sub>
C5	V <sub>IN</sub>	F3	PGND	K6	V <sub>OUT</sub>	C11	MARG1
C6	V <sub>IN</sub>	F4	PGND	K7	V <sub>OUT</sub>	C12	MARG0
		F5	PGND	K8	V <sub>OUT</sub>	D7	-
		F6	PGND	K9	V <sub>OUT</sub>	D8	-
		F7	PGND	K10	V <sub>OUT</sub>	D9	SGND
		F8	PGND	K11	V <sub>OUT</sub>	D10	-
		F9	PGND	L1	V <sub>OUT</sub>	D11	COMP
		G1	PGND	L2	V <sub>OUT</sub>	D12	MARG1
		G2	PGND	L3	V <sub>OUT</sub>	E9	-
		G3	PGND	L4	V <sub>OUT</sub>	E10	-
		G4	PGND	L5	V <sub>OUT</sub>	E11	DRV <sub>CC</sub>
		G5	PGND	L6	V <sub>OUT</sub>	E12	DRV <sub>CC</sub>
		G6	PGND	L7	V <sub>OUT</sub>	F10	-
		G7	PGND	L8	V <sub>OUT</sub>	F11	-
		G8	PGND	L9	V <sub>OUT</sub>	F12	V <sub>FB</sub>
		G9	PGND	L10	V <sub>OUT</sub>	G12	PGOOD
		G10	PGND	L11	V <sub>OUT</sub>	H12	SGND
		G11	PGND	M1	V <sub>OUT</sub>	J12	NC
		H1	PGND	M2	V <sub>OUT</sub>	K12	NC
		H2	PGND	M3	V <sub>OUT</sub>	L12	NC
		H3	PGND	M4	V <sub>OUT</sub>	M12	FCB
		H4	PGND	M5	V <sub>OUT</sub>		
		H5	PGND	M6	V <sub>OUT</sub>		
		H6	PGND	M7	V <sub>OUT</sub>		
		H7	PGND	M8	V <sub>OUT</sub>		
		H8	PGND	M9	V <sub>OUT</sub>		
		H9	PGND	M10	V <sub>OUT</sub>		
		H10	PGND	M11	V <sub>OUT</sub>		
		H11	PGND				



# PACKAGE DESCRIPTION

**BGA Package**  
**133-Lead (15mm × 15mm × 3.42mm)**  
 (Reference LTC DWG # 05-08-1943 Rev A)

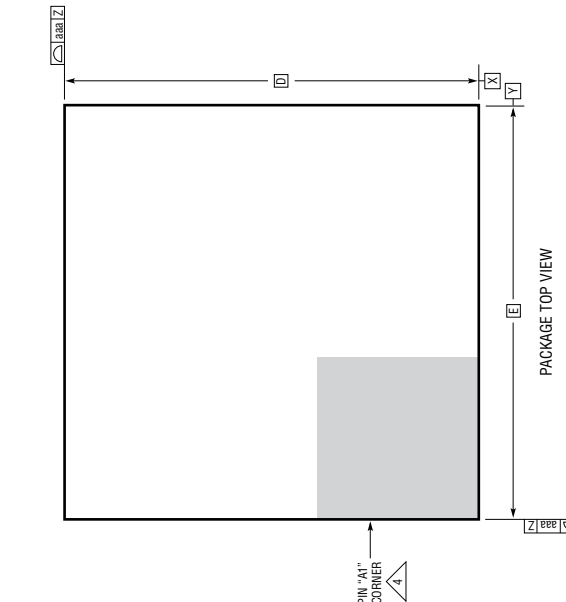
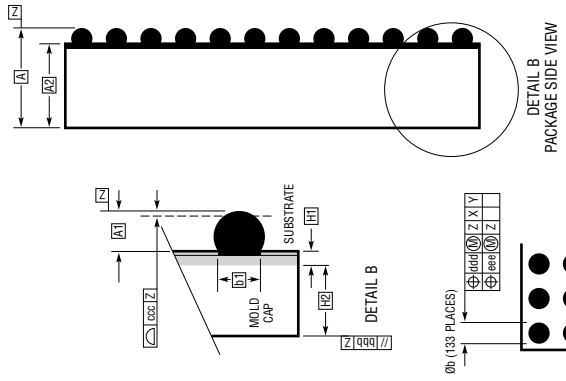
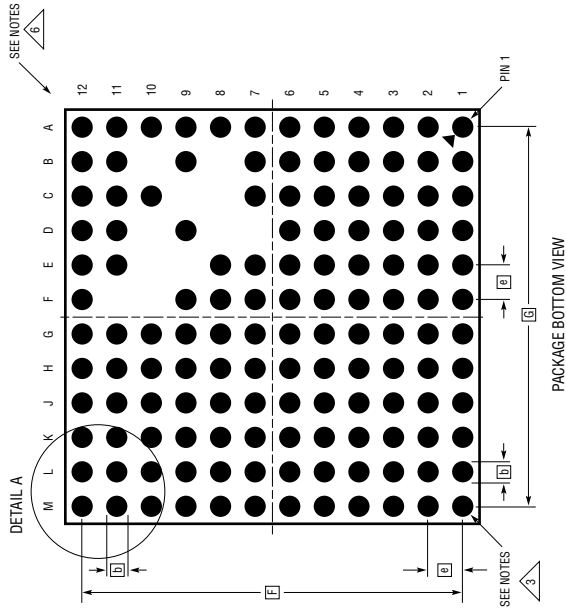

- NOTES:
1. DIMENSIONING AND TOLERANCING PER ASME Y14.5M-1994
  2. ALL DIMENSIONS ARE IN MILLIMETERS
  3. BALL DESIGNATION PER JEDEC MS-028 AND JEP95
  4. DETAILS OF PIN #1 IDENTIFIER ARE OPTIONAL, BUT MUST BE LOCATED WITHIN THE ZONE INDICATED. THE PIN #1 IDENTIFIER MAY BE EITHER A MOLD OR MARKED FEATURE
  5. PRIMARY DATUM -Z-, IS SEATING PLANE
  6. PACKAGE ROW AND COLUMN LABELING MAY VARY AMONG  $\mu$ Module PRODUCTS. REVIEW EACH PACKAGE LAYOUT CAREFULLY

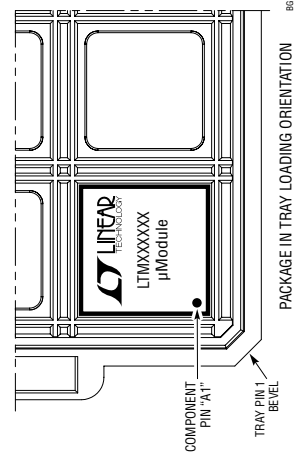

SYMBOL	DIMENSIONS		NOTES
	MIN	NOM	
A	3.22	3.42	3.62
A1	0.50	0.60	0.70
A2	2.72	2.82	2.92
b	0.60	0.75	0.90
b1	0.60	0.63	0.66
D	15.0		
E	15.0		
e	1.27		
F	13.97		
G	13.97		
H1	0.27	0.32	0.37
H2	2.45	2.50	2.55
aaa	SUBSTRATE THK		
bbb	MOLD CAP HT		
ccc	0.10		
ddd	0.20		
eee	0.30		
eee	0.15		
TOTAL NUMBER OF BALLS: 133			

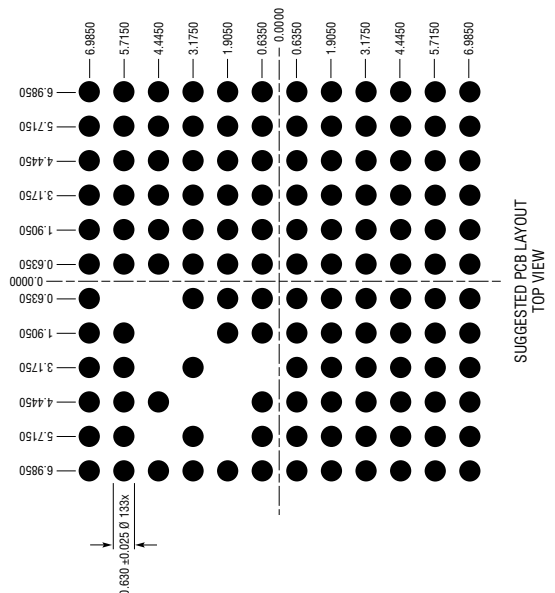

# PACKAGE DESCRIPTION

**LGA Package**  
**133-Lead (15mm × 15mm × 2.82mm)**  
 (Reference LTC DWG # 05-08-1766 Rev A)

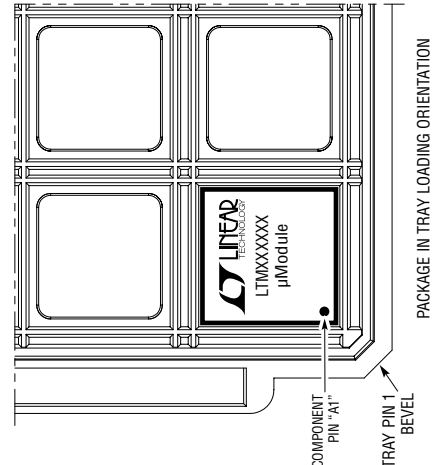
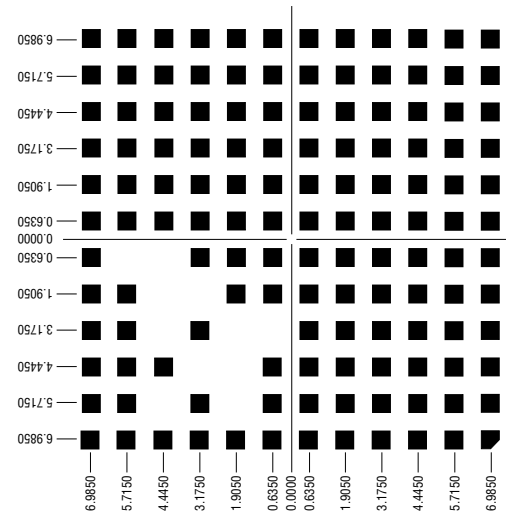
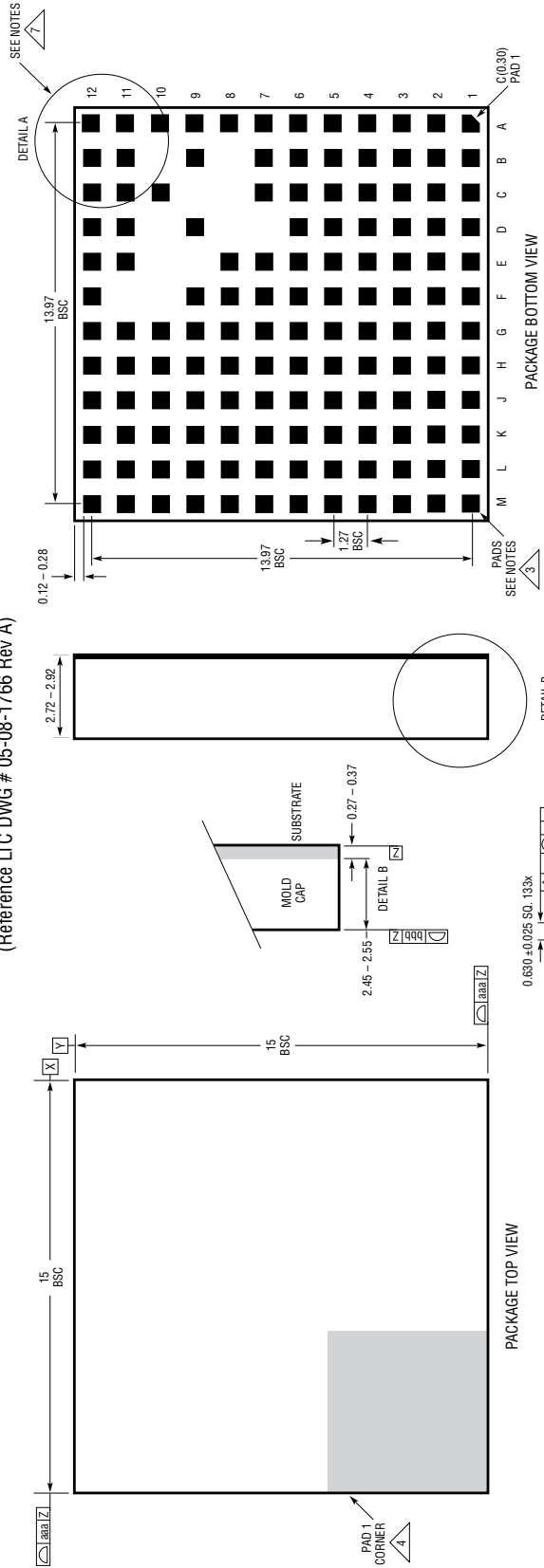

- NOTES:**
1. DIMENSIONING AND TOLERANCING PER ASME Y14.5M-1994
  2. ALL DIMENSIONS ARE IN MILLIMETERS
  3. LAND DESIGNATION PER JEDEC MO-222, SPP-010
  4. DETAILS OF PAD #1 IDENTIFIER ARE OPTIONAL, BUT MUST BE LOCATED WITHIN THE ZONE INDICATED. THE PAD #1 IDENTIFIER MAY BE EITHER A MOLD OR MARKED FEATURE
  5. PRIMARY DATUM -Z- IS SEATING PLANE
  6. THE TOTAL NUMBER OF PADS: 133
  7. PACKAGE ROW AND COLUMN LABELING MAY VARY AMONG μModule PRODUCTS. REVIEW EACH PACKAGE LAYOUT CAREFULLY

SYMBOL	TOLERANCE
aaa	0.10
bbb	0.10
eee	0.05

## REVISION HISTORY

REV	DATE	DESCRIPTION	PAGE NUMBER
A	3/10	Change to Features.	1
		Change to Absolute Maximum Ratings.	2
		Changes to Electrical Characteristics.	2, 3
		Changes to Related Parts.	25
B	3/11	Text updated throughout the data sheet.	1-28
		Graph replaced on the front page, Figure 2, and Figure 16.	1, 12, 17
		Added value of 1 $\mu$ H to inductor on Figure 1.	9
		Updated Related Parts.	28
C	10/13	Add BGA Package Option.	1, 2, 19, 25, 28
		Add Start Into Pre-Bias Output Graph.	6
		Clarify Voltage Margining function.	11
		Add Recommended External Heat Sink Vendors.	19
		Update LGA Package Outline Drawing.	26
D	2/14	Added SnPb package option.	1, 2
E	6/21	Added MPV to part marking.	2

## PACKAGE PHOTOGRAPH

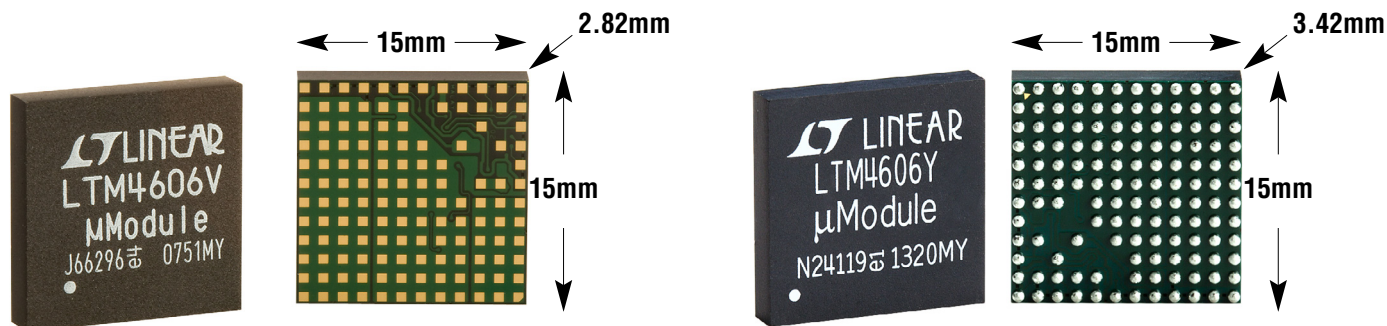

## RELATED PARTS

PART NUMBER	DESCRIPTION	COMMENTS
<a href="#">LTM4601/ LTM4601A</a>	12A DC/DC $\mu$ Module Regulator with PLL, Output Tracking/Margining and Remote Sensing	Synchronizable, PolyPhase Operation, LTM4601-1/LTM4601A-1 Version Has No Remote Sensing, LGA Package
<a href="#">LTM4618</a>	6A DC/DC $\mu$ Module Regulator with PLL, Output Tracking	$4.5V \leq V_{IN} \leq 26.5V$ , $0.8V \leq V_{OUT} \leq 5V$ , Synchronizable, 9mm $\times$ 15mm $\times$ 4.3mm LGA Package
<a href="#">LTM4604A</a>	Low $V_{IN}$ 4A DC/DC $\mu$ Module Regulator	$2.375V \leq V_{IN} \leq 5.5V$ , $0.8V \leq V_{OUT} \leq 5V$ , 9mm $\times$ 15mm $\times$ 2.3mm LGA Package
<a href="#">LTM4608A</a>	Low $V_{IN}$ 8A DC/DC $\mu$ Module Regulator	$2.375V \leq V_{IN} \leq 5.5V$ , $0.6V \leq V_{OUT} \leq 5V$ , 9mm $\times$ 15mm $\times$ 2.8mm LGA Package
<a href="#">LTM4612</a>	Low Noise 5A, 15 $V_{OUT}$ DC/DC $\mu$ Module Regulator	Low Noise, with PLL, Output Tracking and Margining, LTM4606 Pin-Compatible
<a href="#">LTM4613</a>	Low Noise 8A, 15 $V_{OUT}$ DC/DC $\mu$ Module Regulator	Low Noise, with PLL, Output Tracking and Margining, EN55022B Compliant
<a href="#">LTM4627</a>	15A DC/DC $\mu$ Module Regulator	$4.5V \leq V_{IN} \leq 20V$ , $0.6V \leq V_{OUT} \leq 5V$ , $\pm 1.5\%$ Total DC Output Accuracy, 15mm $\times$ 15mm $\times$ 4.32mm LGA Package

EN55022 Class B Certified DC/DC  $\mu$ Module Regulators

<a href="#">LTM8020</a>	High $V_{IN}$ 0.2A DC/DC Step-Down $\mu$ Module Regulator	$4V \leq V_{IN} \leq 36V$ , $1.25V \leq V_{OUT} \leq 5V$ , 6.25mm $\times$ 6.25mm $\times$ 2.3mm LGA Package
<a href="#">LTM8021</a>	High $V_{IN}$ 0.5A DC/DC Step-Down $\mu$ Module Regulator	$3V \leq V_{IN} \leq 36V$ , $0.8V \leq V_{OUT} \leq 5V$ , 6.25mm $\times$ 11.25mm $\times$ 2.8mm LGA Package
<a href="#">LTM8022/ LTM8023</a>	36 $V_{IN}$ , 1A and 2A DC/DC $\mu$ Module Regulators	Pin Compatible, $4.5V \leq V_{IN} \leq 36V$ , 9mm $\times$ 11.25mm $\times$ 2.8mm LGA Package
<a href="#">LTM8031/ LTM8032</a>	1A, 2A EMC DC/DC $\mu$ Module Regulators	EN55022 Class B Compliant, $3.6V \leq V_{IN} \leq 36V$ , $0.8V \leq V_{OUT} \leq 10V$ , Pin Compatible, 9mm $\times$ 15mm $\times$ 2.82mm LGA Package
<a href="#">LTM8033</a>	3A EMC DC/DC $\mu$ Module Regulator	$3.6V \leq V_{IN} \leq 36V$ , $0.8V \leq V_{OUT} \leq 24V$ , 11.25mm $\times$ 15mm $\times$ 4.32mm LGA Package

## X-ON Electronics

Largest Supplier of Electrical and Electronic Components

*Click to view similar products for* [Power Management IC Development Tools](#) *category:*

*Click to view products by* [Analog Devices](#) *manufacturer:*

Other Similar products are found below :

[EVAL-ADM1168LQEBZ](#) [EVB-EP5348UI](#) [MIC23451-AAAYFL EV](#) [MIC5281YMME EV](#) [DA9063-EVAL](#) [ADP122-3.3-EVALZ](#) [ADP130-0.8-EVALZ](#) [ADP130-1.2-EVALZ](#) [ADP130-1.5-EVALZ](#) [ADP130-1.8-EVALZ](#) [ADP1714-3.3-EVALZ](#) [ADP1716-2.5-EVALZ](#) [ADP1740-1.5-EVALZ](#) [ADP1752-1.5-EVALZ](#) [ADP1828LC-EVALZ](#) [ADP1870-0.3-EVALZ](#) [ADP1871-0.6-EVALZ](#) [ADP1873-0.6-EVALZ](#) [ADP1874-0.3-EVALZ](#) [ADP1882-1.0-EVALZ](#) [ADP199CB-EVALZ](#) [ADP2102-1.25-EVALZ](#) [ADP2102-1.875EVALZ](#) [ADP2102-1.8-EVALZ](#) [ADP2102-2-EVALZ](#) [ADP2102-3-EVALZ](#) [ADP2102-4-EVALZ](#) [ADP2106-1.8-EVALZ](#) [ADP2147CB-110EVALZ](#) [AS3606-DB](#) [BQ24010EVM](#) [BQ24075TEVM](#) [BQ24155EVM](#) [BQ24157EVM-697](#) [BQ24160EVM-742](#) [BQ24296MEVM-655](#) [BQ25010EVM](#) [BQ3055EVM](#) [NCV891330PD50GEVB](#) [ISLUSBI2CKIT1Z](#) [LM2744EVAL](#) [LM2854EVAL](#) [LM3658SD-AEV/NOPB](#) [LM3658SDEV/NOPB](#) [LM3691TL-1.8EV/NOPB](#) [LM4510SDEV/NOPB](#) [LM5033SD-EVAL](#) [LP38512TS-1.8EV](#) [EVAL-ADM1186-1MBZ](#) [EVAL-ADM1186-2MBZ](#)