

## DESCRIPTION

Demonstration circuit 1317A-E is isolated input to high current output 1/8th Brick footprint converter featuring the LT<sup>®</sup>1952 switching controller with Active Reset circuit. The Active Reset circuit can improve the efficiency in wide input voltage applications. Also, the Active Reset allows the implementation of self-driven synchronous secondary rectifiers in some applications.

The DC1317A-E converts isolated 36V to 72V input to 5V output and provides over 12A of output current. The converter operates at 260kHz with the peak efficiency greater than 94% at 8A load. The DC1317 can be easily modified to generate output voltages in the range from 0.6V to 48V. The output currents are limited by total output power of up to 150W.

The other available versions of DC1317A are:

DC1317A-A, 36-72V<sub>in</sub> to 3.3V, 30A

DC1317A-B, 18-72V<sub>in</sub> to 5V, 25A

DC1317A-C, 18-72V<sub>in</sub> to 12V, 10A

DC1317A-D, 18-72V<sub>in</sub> to 24V, 5A

DC1317A-F, 9-36V<sub>in</sub> to 3.3V, 20A

DC1317A-G, 9-36V<sub>in</sub> to 12V, 5A

DC1317A-H, 9-36V<sub>in</sub> to 48V, 1.5A

The DC1317 circuit features soft-start which prevents output voltage overshoot on startup or when recovering from overload condition.

The DC1317 has precise over-current protection circuit that allows for continuous operation under short circuit conditions. The low power dissipation under short circuit conditions insures high reliability even during short circuits.

The LT1952 can be synchronized to an external clock of up to 400kHz. Please refer to LT1952 data sheet for design details and applications information.

**Design files for this circuit board are available. Call the LTC factory.**

LT is a trademark of Linear Technology Corporation

Table 1. Performance Summary

PARAMETER	CONDITION	VALUE
Minimum Input Voltage	I <sub>OUT</sub> = 0A to 12A	36V
Maximum Input Voltage	I <sub>OUT</sub> = 0A to 12A	72V
V <sub>OUT</sub>	V <sub>IN</sub> = 36V to 72V, I <sub>OUT</sub> = 0A to 12A	5V ±3%
Typical Output Ripple V <sub>OUT</sub>	V <sub>IN</sub> = 36V to 72V, I <sub>OUT</sub> = 0A to 12A	50mV <sub>P-P</sub>
Nominal Switching Frequency		260kHz

## QUICK START PROCEDURE

Demonstration circuit 1317 is easy to set up to evaluate the performance of LT1952 circuit. **Refer to Figure 1 for proper measurement equipment setup** and follow the procedure below:

**NOTE:** When measuring the input or output voltage ripple, care must be taken to avoid a long ground lead on the oscilloscope probe. Measure the input or output voltage ripple by touching the probe tip di-

# QUICK START GUIDE FOR DEMONSTRATION CIRCUIT 1317A-E

## ACTIVE RESET ISOLATED DC/DC POWER CONVERTER

rectly across the Vin or Vout and GND terminals. See Figure 2. for proper scope probe technique.

1. With power off, connect the input power supply to Vin and GND. Make sure that the input power supply has sufficient current rating at minimum input voltage for the required output load.

2. Turn on the power at the input.

**NOTE:** Make sure that the input voltage does not exceed 72V.

3. Check for the proper output voltage.

Vout = 5V.

If there is no output, temporarily disconnect the load to make sure that the load is not set too high.

4. Once the proper output voltage is established, adjust the load within the operating range and observe the output voltage regulation, ripple voltage, efficiency and other parameters.

5. The DC1317 is equipped with an output capacitor CSYS (470uF) that approximates typical system rail capacitance. If system board already has capacitance of similar value CSYS can be removed.

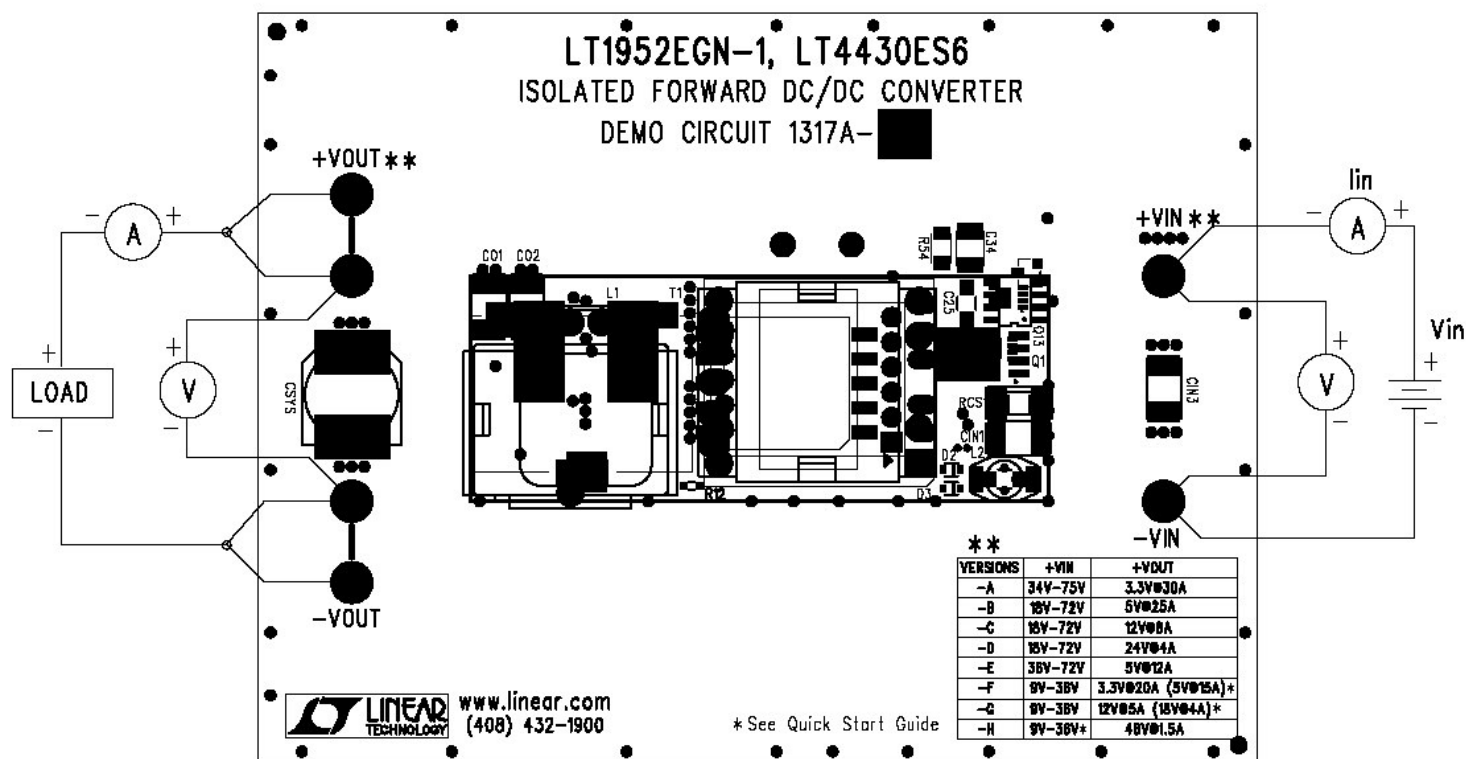
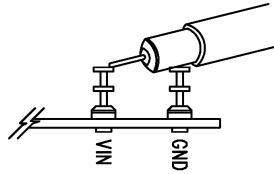

Figure 1. Proper Measurement Equipment Setup



**Figure 2. Scope Probe Placement for Measuring Input or Output Ripple**

### PRIMARY MOSFET DRIVER LTC4440

The DC1317 has an optional LTC4440 MOSFET driver U2. The LTC4440 can be used if much bigger MOSFETs are used. Please contact LT factory for assistance.

### ACTIVE RESET CIRCUIT

The DC1317 is equipped with an active reset circuit that consists of Q13 and C25. The capacitor C25 charges to the appropriate transformer reset voltage. The MOSFET Q13 applies the C25 reset voltage across the primary of transformer T1. The C25 reset voltage varies with the duty cycle and automatically adjusts to provide volt-second balance for transformer magnetizing current.

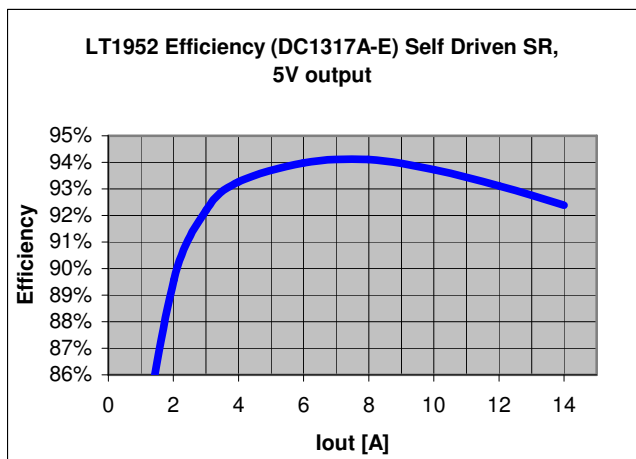

**Figure 3. High efficiency of DC1317A-E allows the board to be used in thermally demanding applications**

### OUTPUT LOAD STEP RESPONSE

The load step response of DC1317A-E is very fast even though relatively small amount of output capacitance is present (100uF ceramic and 470uF electrolytic). This is thanks to fast error amplifier of LT4430, optimal amount of current slope compensation of LT1952, fast opto coupler and fast error amplifier of LT1952. If higher load steps need to be handled more output capacitance can be added in order to keep the voltage transients at the desired level. The load step transients are shown in Figure 4.

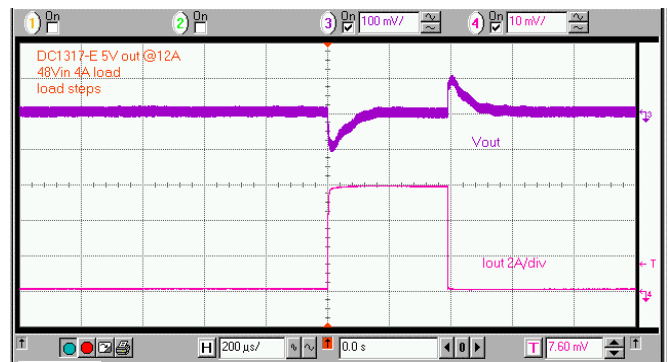

**Figure 4. Fast transient response of DC1317A-E is superior to many competing power modules without the additional output capacitors.**

### SOFT START FUNCTION

The DC1317 features LT4430 opto coupler driver that has soft start function which produces monotonic startup ramp shown in Figure 5. The rise time of output voltage is controlled by capacitor C19 that is connected to OC (overshoot control) pin of LT4430.

# QUICK START GUIDE FOR DEMONSTRATION CIRCUIT 1317A-E

## ACTIVE RESET ISOLATED DC/DC POWER CONVERTER

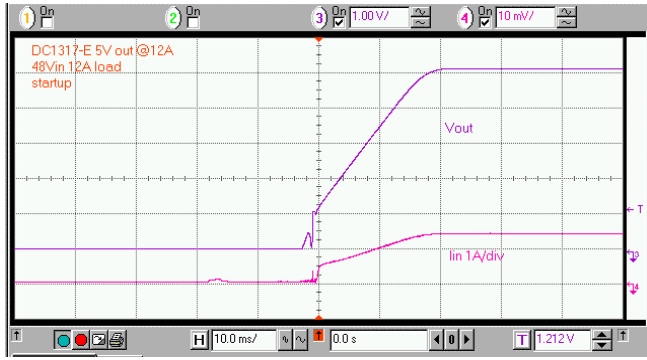

**Figure 5. The LT4430 opto coupler driver produces monotonic output voltage rise at startup without output voltage overshoot.**

### DEBUGGING AND TESTING

The DC1317 can easily be tested and debugged by powering the bias circuit separately from the main power circuit. To place DC1317 into debug mode remove the resistor R1 and connect 48V, 100mA power source to +Vb node (right side of R1). By doing this, the primary PWM controller LT1952 can be activated without the main primary power being applied to +Vin.

To activate the secondary side feedback circuit LT4430 diode OR a 10V, 100mA power source into collector of Q9.

Once the primary and secondary controllers are running the MOSFET gate timing can be checked.

If the MOSFET gate timing is correct the main power input can be applied to +Vin. By slowly increasing the +Vin from 0V to 48V the output voltage and input current can be monitored. The input current should not exceed 100mA without the output load. If one of the MOSFETs is damaged, the input current will exceed 100mA.

### PCB LAYOUT

The pcb layout should be carefully planned to avoid potential noise problems. The PCB layout for DC1317A can be used as a guide. Since demo board DC1317A has 8 versions the PCB layout has optional

components that can be removed. Also, the PCB layout has a common schematic that is used just for the layout. The actual circuit schematic shows component values. In some cases, a resistor is used in place of a capacitor as in case of C4. Please modify the reference designators in your schematic to reflect the actual component used. The following simple PCB layout rules should be helpful.

If possible use solid ground planes on layers 2 and N-1. The ground planes will prevent the switching noise from coupling into sensitive lines.

Place sensitive lines on the inner layers that will be shielded by grounds on layers 2 and N-1.

Keep the loop formed by Q1, RCS1, Cin and T1 tight.

Keep the loop formed by Q2, Q3 and T1 tight.

Keep noise sensitive nodes like SD/VSEC, ROsc, FB, COMP, ISENSE, BLANK and DELAY as small as possible by placing the associated components close to the LT1952 and LT4430 chips.

Use local vias for all components that connect to ground planes.

Do not place any traces on the layers 2 and N-1 to avoid ground planes from being compromised.

If the PCB layout has to be done on 2 or 4-layer PCB use the same guidelines as outlined above. Also, maximize the ground connections between components by placing the components tight together.

Please contact LT factory for additional assistance.

# QUICK START GUIDE FOR DEMONSTRATION CIRCUIT

## ACTIVE RESET ISOLATED DC/DC POWER SUPPLY

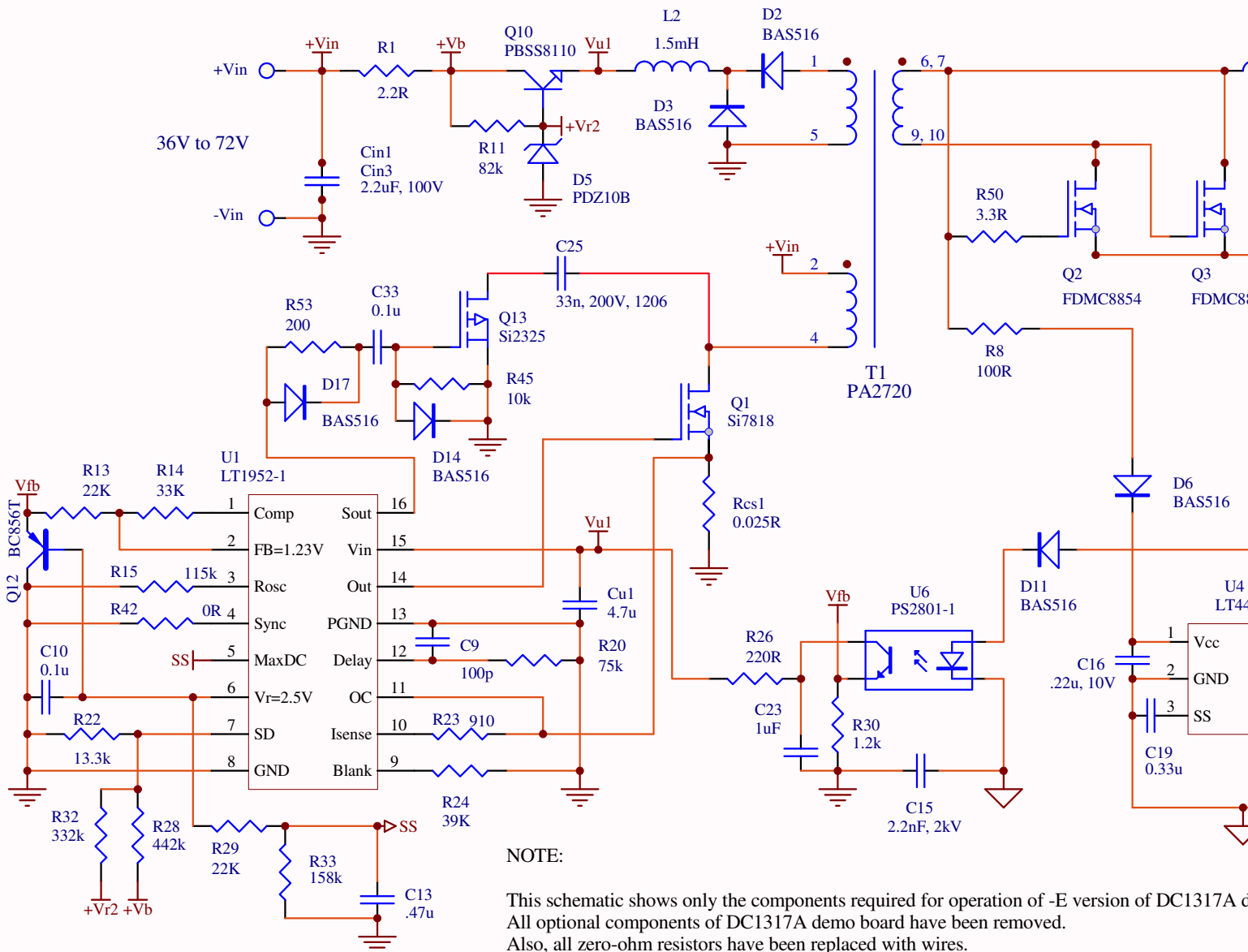

**NOTE:**

This schematic shows only the components required for operation of -E version of DC1317A. All optional components of DC1317A demo board have been removed. Also, all zero-ohm resistors have been replaced with wires. Please consult the full DC1317A-E schematic to decide if any of the optional components should be included.

**DC1317A-E schematic**

# QUICK START GUIDE FOR DEMONSTRATION CIRCUIT 1317A-E

## ACTIVE RESET ISOLATED DC/DC POWER CONVERTER

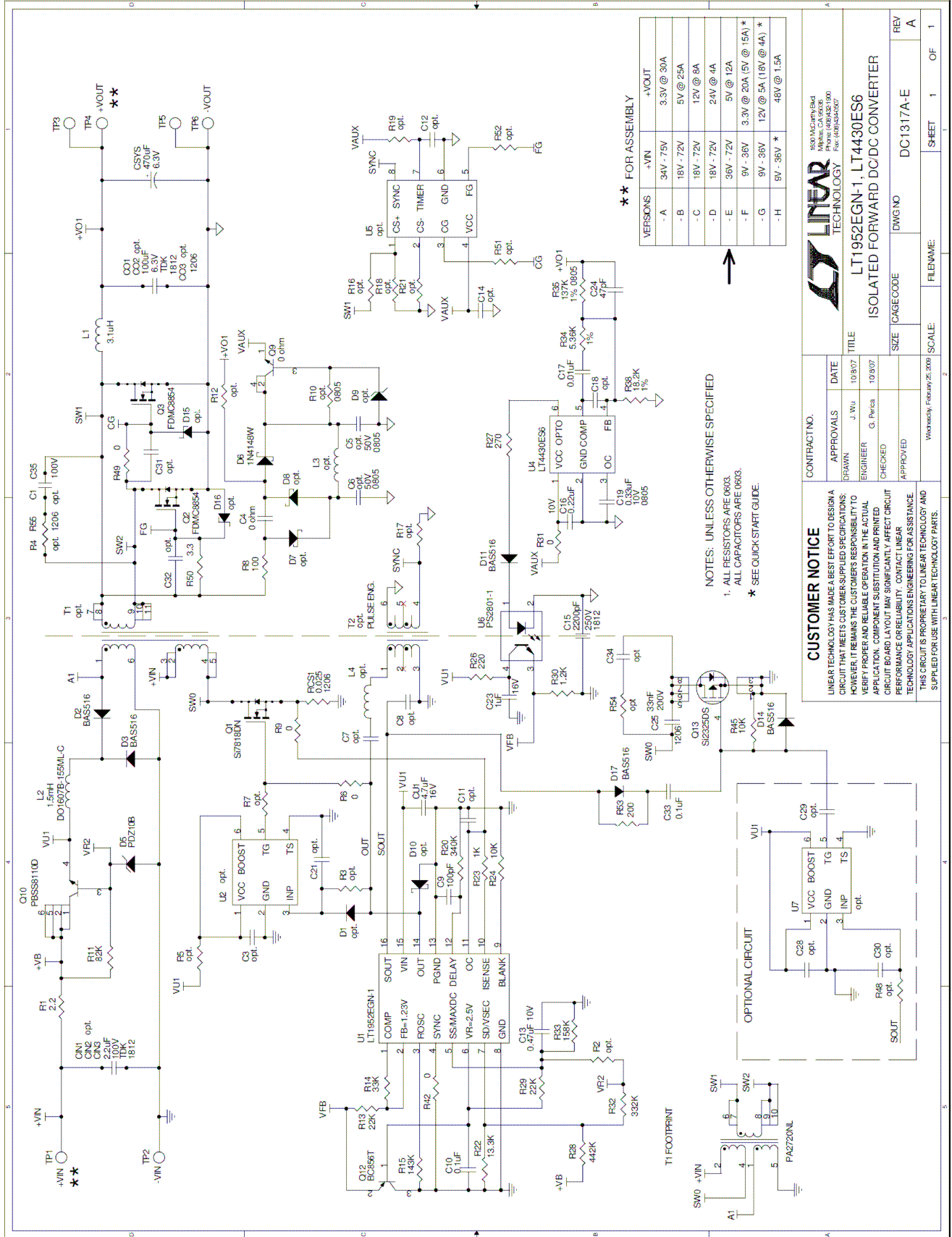

# QUICK START GUIDE FOR DEMONSTRATION CIRCUIT 1317A-E

## ACTIVE RESET ISOLATED DC/DC POWER CONVERTER

**NOTES: UNLESS OTHERWISE SPECIFIED**

1. WORKMANSHIP SHALL BE IN ACCORDANCE WITH IPC-A-610.
3. PARTS TO OMIT WILL BE SPECIFIED ON THE BILLS OF MATERIAL. LOCATIONS OF OMITTED PARTS SHALL BE FREE OF SOLDER. MASK THE SOLDER STENCIL WHERE SMT PARTS ARE OMITTED.
4. DEPANELIZE BOARDS AFTER ASSEMBLY AND ROUTE-OUT THE BREAKOUT TABS ON FOUR SIDES OF THE BOARD EDGE.
6. INSTALL 4 RUBBER FEET (BUMPON SJ-5303) AT 4 CORNERS AS SHOWN BELOW:

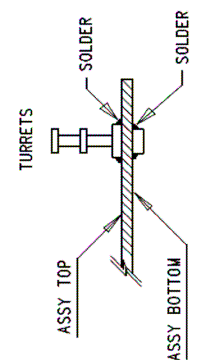
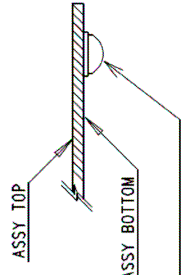

**ASSY DRAWING (BOTTOM VIEW)**

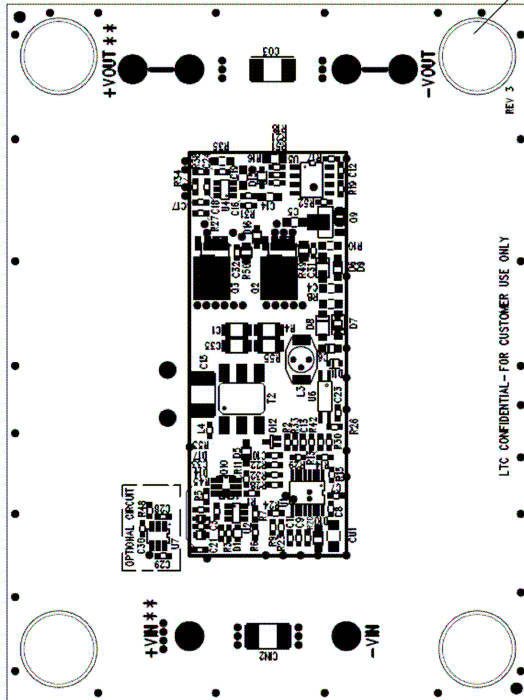

**BOTTOM VIEW**

Q1 INSTALLATION FOR "-E"

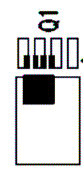

Q13 INSTALLATION FOR "-E"

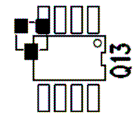

<b>APPROVALS</b>		 1630 McCarthy Blvd. Milpitas, CA 95035 PH: (408)432-1900	<b>TITLE:</b> LT1952EGN-1, LT4430ES6 ISOLATED FORWARD DC/DC CONVERTER	<b>SIZE</b> A <b>DEMO CIRCUIT</b> DC1317A-E <b>REV.</b> A	SHT 1 of 1
INIT	DATE				
DRAWN	CHECK				
DESIGN	J. WU 9/20/07				
ENGR	G. PERICA 9/20/07				
SCALE = NONE					

## X-ON Electronics

Largest Supplier of Electrical and Electronic Components

*Click to view similar products for [Power Management IC Development Tools](#) category:*

*Click to view products by [Analog Devices](#) manufacturer:*

Other Similar products are found below :

[EVAL-ADM1168LQEBZ](#) [EVB-EP5348UI](#) [MIC23451-AAAYFL EV](#) [MIC5281YMME EV](#) [DA9063-EVAL](#) [ADP122-3.3-EVALZ](#) [ADP130-0.8-EVALZ](#) [ADP130-1.2-EVALZ](#) [ADP130-1.5-EVALZ](#) [ADP130-1.8-EVALZ](#) [ADP1714-3.3-EVALZ](#) [ADP1716-2.5-EVALZ](#) [ADP1740-1.5-EVALZ](#) [ADP1752-1.5-EVALZ](#) [ADP1828LC-EVALZ](#) [ADP1870-0.3-EVALZ](#) [ADP1871-0.6-EVALZ](#) [ADP1873-0.6-EVALZ](#) [ADP1874-0.3-EVALZ](#) [ADP1882-1.0-EVALZ](#) [ADP199CB-EVALZ](#) [ADP2102-1.25-EVALZ](#) [ADP2102-1.875EVALZ](#) [ADP2102-1.8-EVALZ](#) [ADP2102-2-EVALZ](#) [ADP2102-3-EVALZ](#) [ADP2102-4-EVALZ](#) [ADP2106-1.8-EVALZ](#) [ADP2147CB-110EVALZ](#) [AS3606-DB](#) [BQ24010EVM](#) [BQ24075TEVM](#) [BQ24155EVM](#) [BQ24157EVM-697](#) [BQ24160EVM-742](#) [BQ24296MEVM-655](#) [BQ25010EVM](#) [BQ3055EVM](#) [NCV891330PD50GEVB](#) [ISLUSBI2CKIT1Z](#) [LM2744EVAL](#) [LM2854EVAL](#) [LM3658SD-AEV/NOPB](#) [LM3658SDEV/NOPB](#) [LM3691TL-1.8EV/NOPB](#) [LM4510SDEV/NOPB](#) [LM5033SD-EVAL](#) [LP38512TS-1.8EV](#) [EVAL-ADM1186-1MBZ](#) [EVAL-ADM1186-2MBZ](#)