

LTC3615
DUAL 4 MHz, 3A SYNCHRONOUS
STEP-DOWN DC/DC CONVERTER

DESCRIPTION

Demonstration circuit 1435 is a dual output regulator consisting of two constant-frequency step-down converters, based on the LTC3615 dual channel monolithic synchronous buck regulator. The DC1435 has an input voltage range of 2.25V to 5.5V, with each regulator capable of delivering up to 3A of output current. The DC1435 can operate in Burst Mode™, pulse-skip or forced continuous mode. In shutdown, the DC1435 requires less than 100 uA total. The DC1435 is a very efficient circuit: over 90%

for either circuit. The LTC3615 comes in a 24 Pin QFN or leaded package, which each having an exposed pad on the bottom-side of the IC for better thermal performance. These features, plus a programmable operating frequency range from 400 kHz to 4 MHz (2.25 MHz switching frequency with the RT pin connected to INTVcc), make the DC1435 demo board an ideal circuit for use industrial or distributed power applications. **Gerber files for this circuit are available. Call the LTC Factory.**

QUICK START PROCEDURE

The DC1435 is easy to set up to evaluate the performance of the LTC3615. For a proper measurement equipment configuration, set up the circuit according to the diagram in Fig. 1.

NOTE: When measuring the input or output voltage ripple, care must be taken to avoid a long ground lead on the oscilloscope probe. Measure the input or output voltage ripple by touching the probe tip directly across the Vin or Vout and GND terminals. See the proper scope probe technique in figure 2.

Please follow the procedure outlined below for proper operation.

1. Connect the input power supply to the Vin and GND terminals. Connect the loads between the Vout and GND terminals. Refer to figure 1 for the proper measurement equipment setup.

Before proceeding to operation, insert jumper shunts XJP1 and XJP2 into the OFF positions of headers J1 and J2, shunt XJP5 into the 180°out-of-phase position of PHASE header J5, shunts XJP3 and XJP4 into the soft-start (EXT SS) positions of headers J3 and J4, shunt XJP7 into the forced con-

tinuous mode (FCM) position of MODE header JP7, shunt XJP6 into the 2 MHz (RT) position of the frequency (Rt/SYNC) header JP6, shunts XJPCOMP1 and XJPCOMP2 into the external compensation (ECMP) positions of headers JITH1 and JITH2, and shunt XJP1 into the Vout1 voltage options of choice of header JP1-4: 1.8V, 2.5V, 3.3V, or user select, and shunt XJP2 into the Vout2 voltage options of choice of header JP1-3: 1.2V, 1.5V, 1.8V, or user select.

2. Apply 5.5V at Vin. Measure both Vouts; they should read 0V. If desired, one can measure the shutdown supply current at this point. The supply current will be less than 100 uA in shutdown.

3. Turn on Vout1 and Vout2 by shifting shunts XJP1 and XJP2 from the OFF positions to the ON positions. Both output voltages should be within a tolerance of +/- 2%.

4. Vary the input voltage from the min. Vin (which is dependent on Vout) to 5.5V, and the load currents from 0 to 3A. Both output voltages should be within +/- 4% tolerance.

5. Set the load current of both outputs to 3A and the input voltage to 5.5V, and then measure each output ripple voltage (refer to figure 2 for proper measurement technique); they should each measure less than 30 mVAC. Also, observe the voltage waveform at either switch node of each regulator. The switching frequencies should be between 1.6 MHz and 2.4 MHz ($T = 625$ ns and 417 ns). In all cases, both switch node waveforms should be rectangular in shape, and 180° out-of-phase with each other. Change the shunt position on header J5 to set the switch waveforms in phase with respect to each other. To operate the ckt.s in Burst Mode™ or pulse-skip mode, change the shunt in header J7. When finished, insert shunts XJP1 and XJP2 to the OFF position(s) and disconnect the power.

Warning - If the power for the demo board is carried in long leads, the input voltage at the part could “ring”, which could affect the operation of the circuit or even exceed the maximum voltage rating of the IC. To eliminate the ringing, a small tantalum capacitor (for instance, AVX part # TPSW107M010R0150) is inserted on the pads between the input power and return terminals on the bottom of the demo board. The (greater) ESR of the tantalum will dampen the (possible) ringing voltage due to the use of long input leads. On a normal, typical PCB, with short traces, this capacitor is not needed.

Table 1. Performance Summary ($T_A = 25^\circ\text{C}$)

PARAMETER	CONDITIONS	VALUE
Minimum Input Voltage		2.25V
Maximum Input Voltage		5.5V
Run	RUN Pin = GND	Shutdown
	RUN Pin = V_{IN}	Operating
Output Voltage V_{OUT1}	$V_{IN} = 2.5\text{V to } 5.5\text{V}, I_{OUT1} = 0\text{A to } 3\text{A}$	$1.8\text{V} \pm 4\%$ (1.728V – 1.872V)
	$V_{IN} = 3.3\text{V to } 5.5\text{V}, I_{OUT1} = 0\text{A to } 3\text{A}$	$2.5\text{V} \pm 4\%$ (2.4V – 2.6V)
	$V_{IN} = 3.9\text{V to } 5.5\text{V}, I_{OUT1} = 0\text{A to } 3\text{A}$	$3.3\text{V} \pm 4\%$ (3.168V – 3.432V)
Typical Output Ripple V_{OUT1}	$V_{IN} = 5\text{V}, I_{OUT1} = 3\text{A}$ (20 MHz BW)	< 30mV _{P-P}
Output Regulation V_{OUT1}	Line	$\pm 1\%$
	Load	$\pm 1\%$
Output Voltage V_{OUT2}	$V_{IN} = 2.25\text{V to } 5.5\text{V}, I_{OUT2} = 0\text{A to } 3\text{A}$	$1.2\text{V} \pm 4\%$ (1.152V – 1.248V)
	$V_{IN} = 2.5\text{V to } 5.5\text{V}, I_{OUT2} = 0\text{A to } 3\text{A}$	$1.5\text{V} \pm 4\%$ (1.44V - 1.56V)
	$V_{IN} = 2.5\text{V to } 5.5\text{V}, I_{OUT2} = 0\text{A to } 3\text{A}$	$1.8\text{V} \pm 4\%$ (1.728V – 1.872V)
Typical Output Ripple V_{OUT2}	$V_{IN} = 5\text{V}, I_{OUT2} = 3\text{A}$ (20 MHz BW)	< 30mV _{P-P}
Output Regulation V_{OUT2}	Line	$\pm 1\%$
	Load	$\pm 1\%$
Nominal Switching Frequencies	RT Pin connected to 200k	2 MHz
	RT Pin = INTV _{CC}	2.25 MHz
Burst Mode™ Operation	Channel 1: $V_{in} = 5\text{V}, V_{out1} = 3.3\text{V}$	$I_{out1} = 600$ mA
	Channel 2: $V_{in} = 5\text{V}, V_{out2} = 1.8\text{V}$	$I_{out2} = 700$ mA
Pulse-Skip Operation	Channel 1: $V_{in} = 5\text{V}, V_{out1} = 3.3\text{V}$	$I_{out1} = 600$ mA
	Channel 2: $V_{in} = 5\text{V}, V_{out2} = 1.8\text{V}$	$I_{out2} = 700$ mA
Phase	Phase Pin = SV_{IN}	180°Out-of-Phase
	Phase Pin OPEN	90°Out-of-Phase
	Phase Pin = GND	In Phase

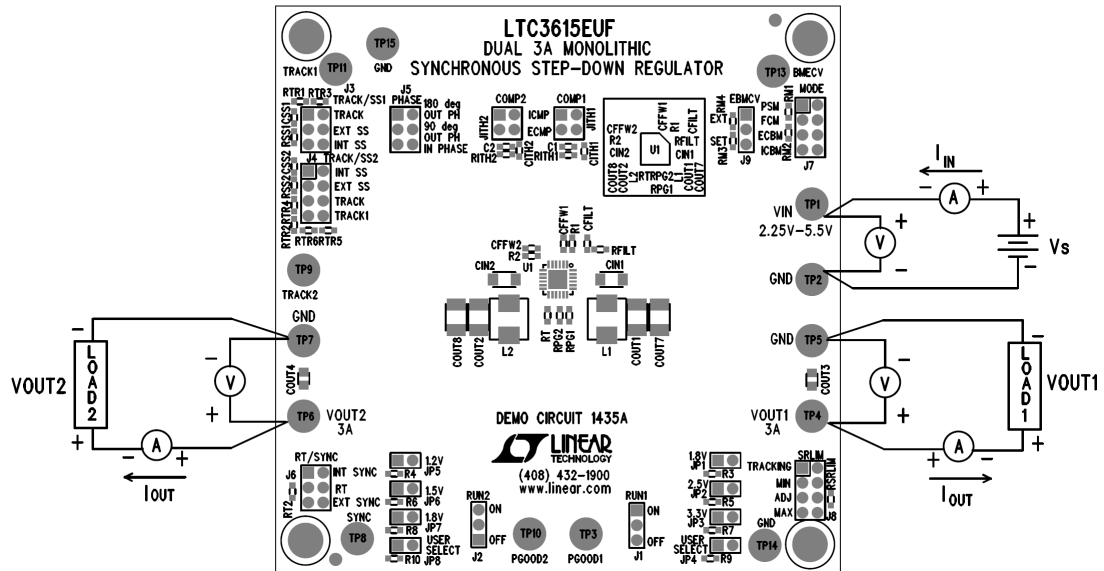

Figure 1. Proper Measurement Equipment Setup

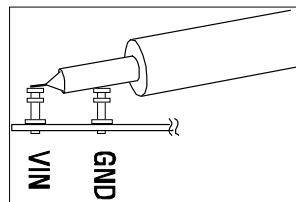

Figure 2. Measuring Input or Output Ripple

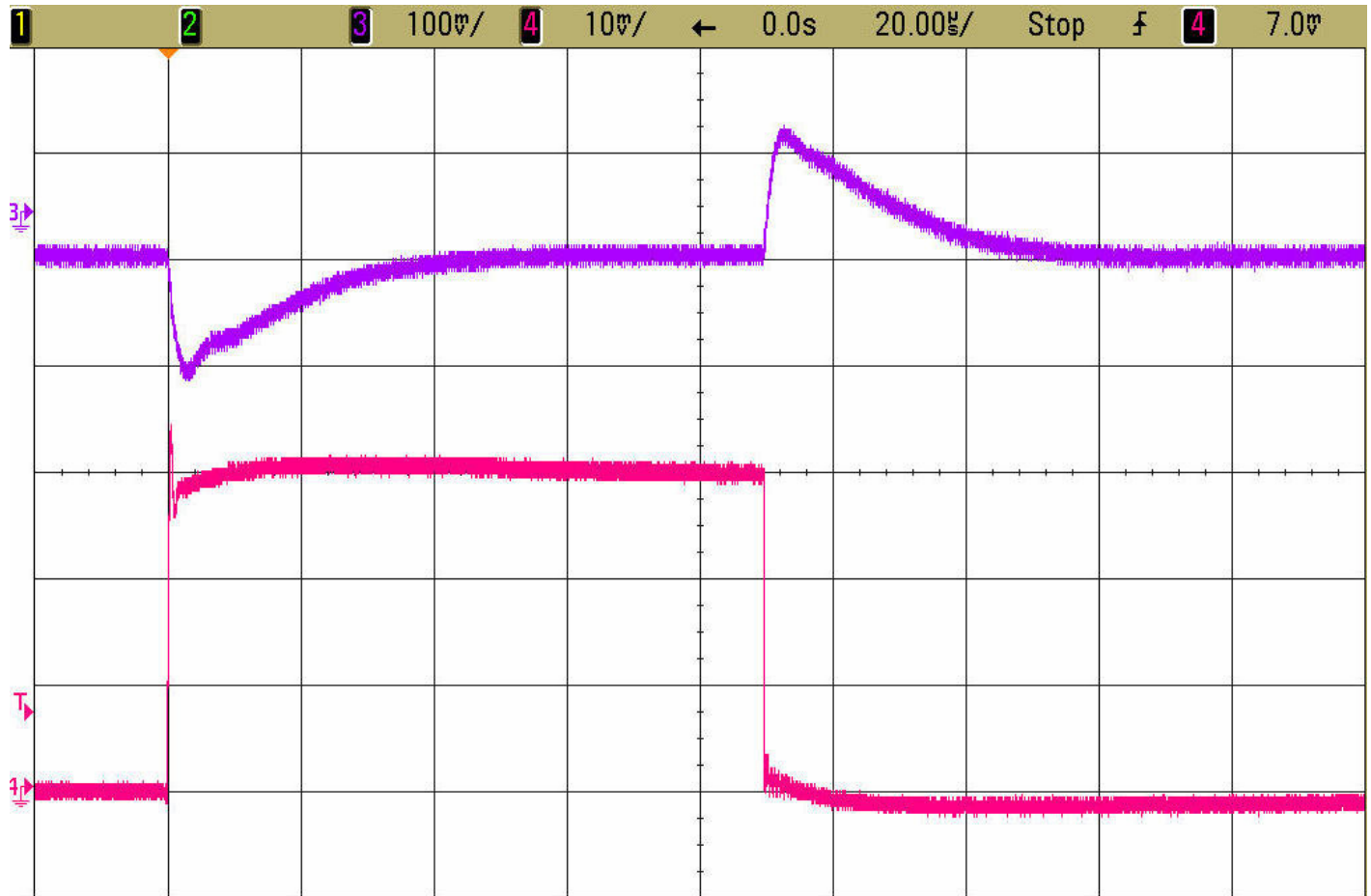

Figure 3. V_{OUT1} Load Step Response

$V_{IN} = 5V$, $V_{OUT1} = 3.3V$, 3A Load Step

Forced Continuous Mode $F_{sw} = 2\text{ MHz}$
External Compensation: $R_{ith} = 43k$, $C_{ith} = 220\text{ pF}$
Trace 3: Output Voltage (100mV/div AC)
Trace 4: Output Current (1A/div)

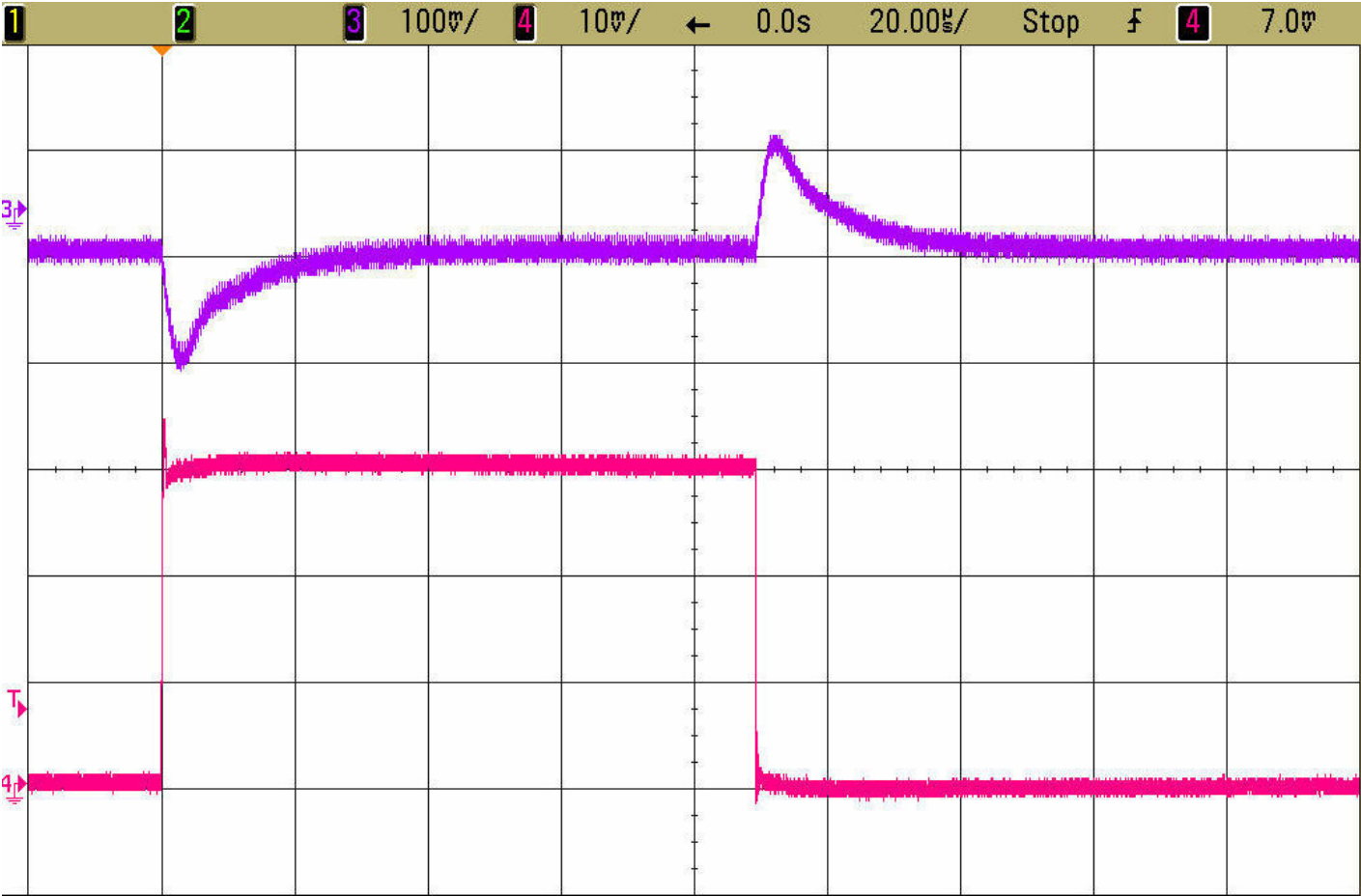

Figure 4. V_{OUT2} Load Step Response

$V_{IN} = 3.3V$, $V_{OUT2} = 1.8V$, 3A Load Step

Forced Continuous Mode $F_{sw} = 2\text{ MHz}$

External Compensation: $R_{ith} = 43k$, $C_{ith} = 220\text{ pF}$

Trace 3: Output Voltage (100mV/div AC)

Trace 4: Output Current (1A/div)

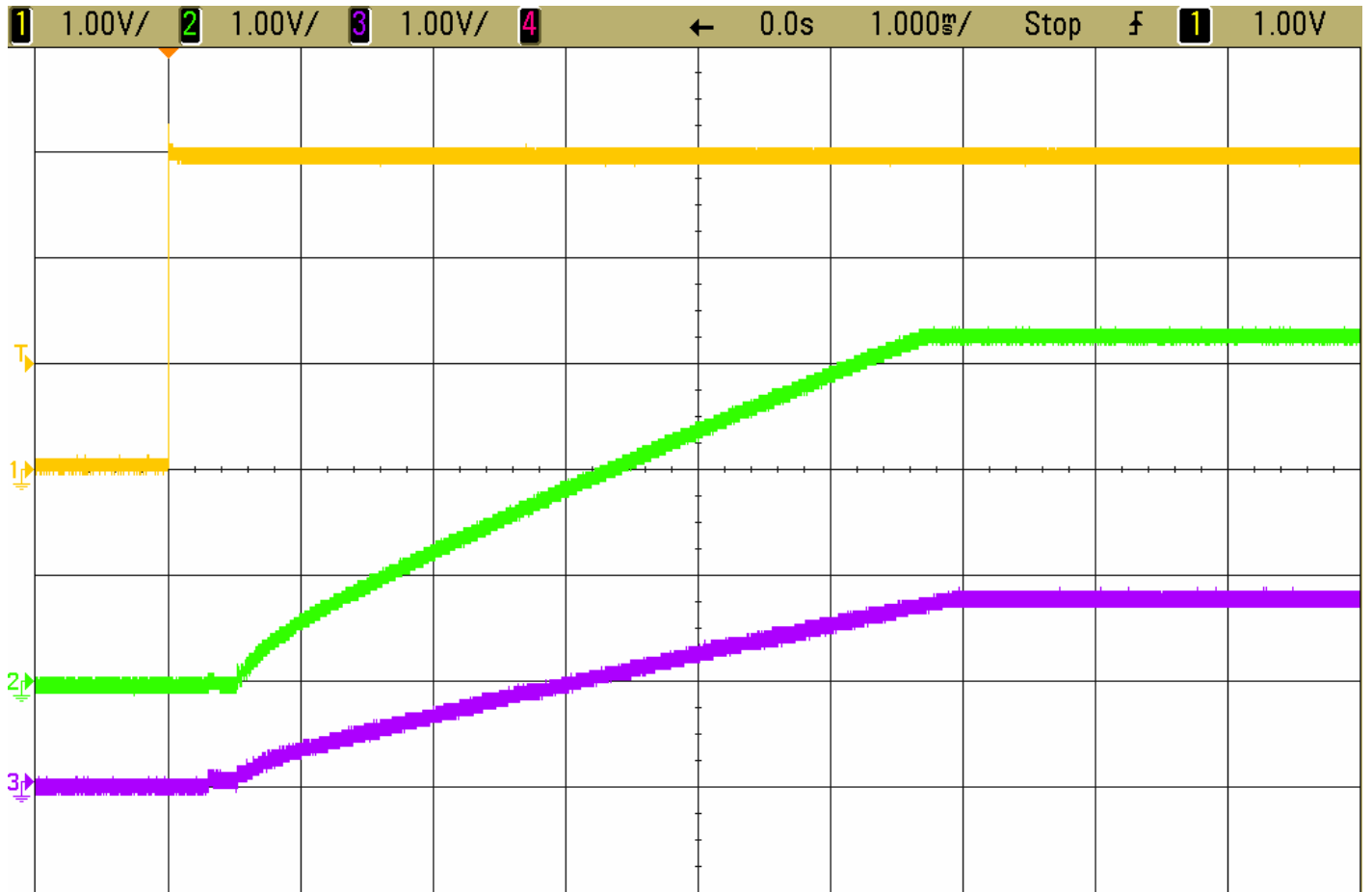

Figure 5. Start-Up Operation

$V_{IN} = 5V$, $V_{OUT1} = 3.3V$, $V_{OUT2} = 1.8V$, 3A Loads

$V_{RUN} = 2.5V$

Forced Continuous Mode $F_{SW} = 2\text{ MHz}$

External Compensation: $R_{ith} = 43k$, $C_{ith} = 220\text{ pF}$

Trace 1: RUN Voltage (1V/div)

Trace 2: Channel 1 Output Voltage (1V/div)

Trace 3: Channel 2 Output Voltage (1V/div)

LTC3615EUF DC1435 Efficiency Graph

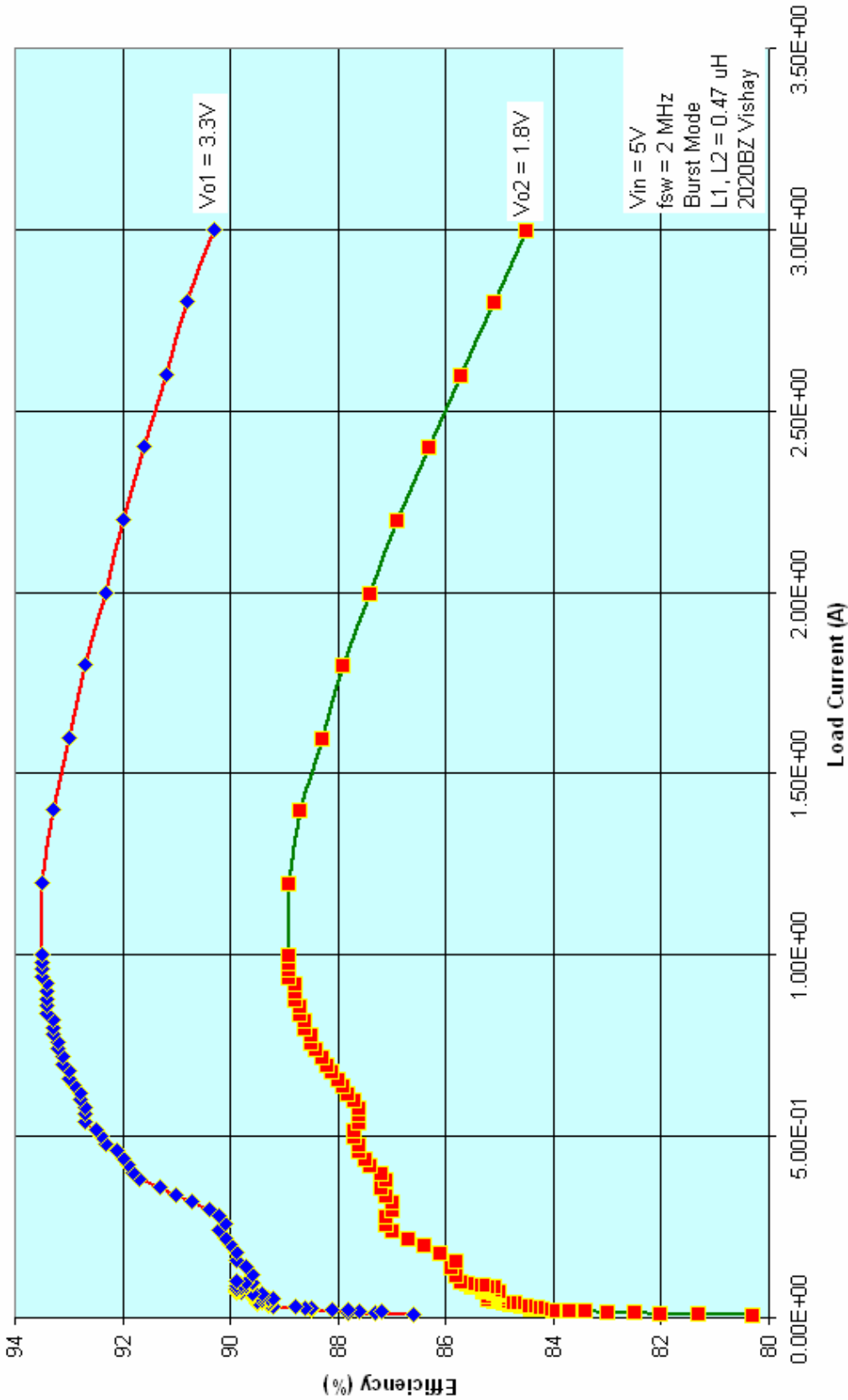

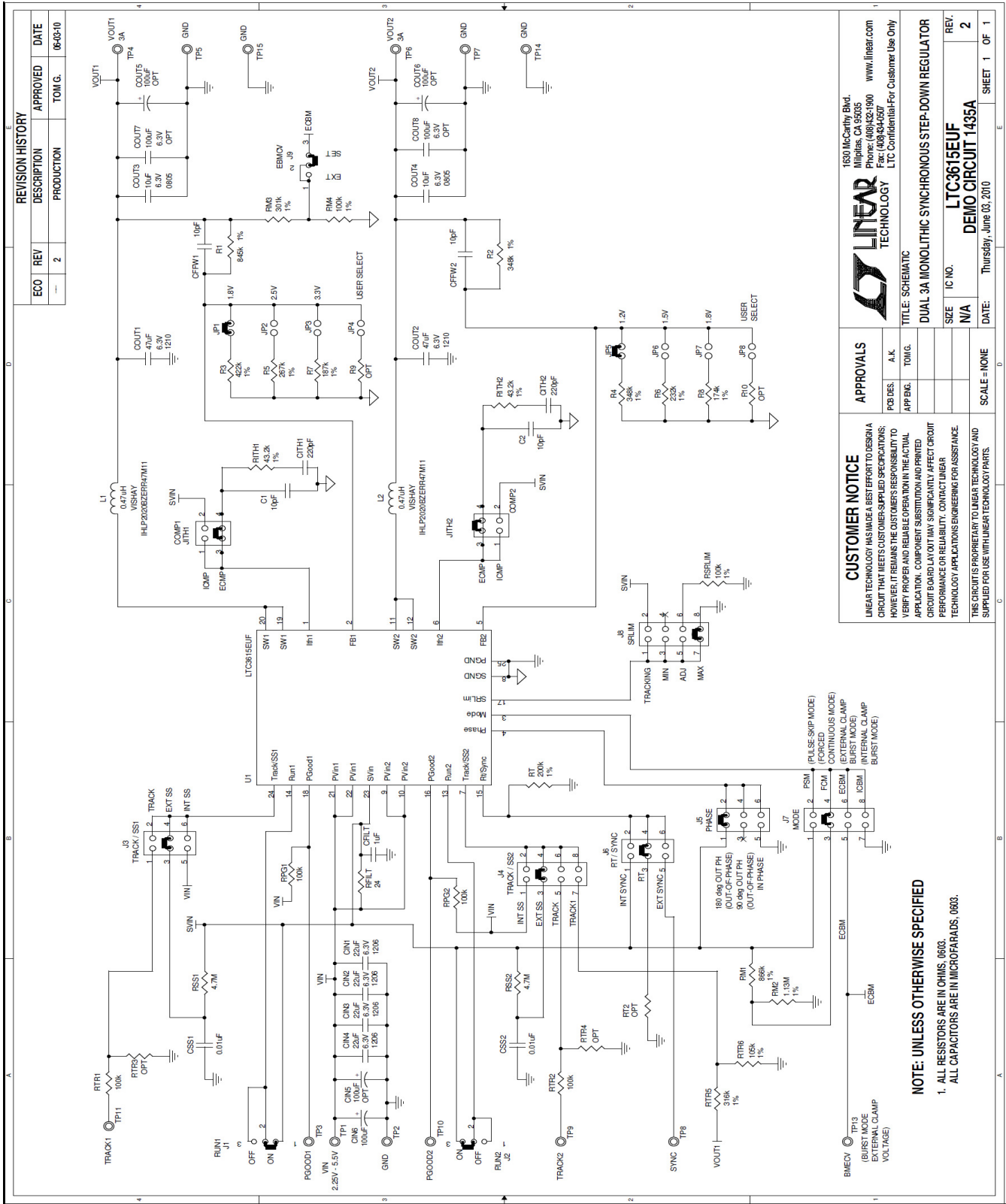

REVISION HISTORY			
ECO	REV	DESCRIPTION	DATE
---	2	PRODUCTION	06-03-10

APPROVALS		TITLE	
DESIGNER	A.K.	DESCRIPTION	DATE
		DUAL 3A MONOLITHIC SYNCHRONOUS STEP-DOWN REGULATOR	
		SCHEMATIC	

CUSTOMER NOTICE
 LINEAR TECHNOLOGY HAS MADE A BEST EFFORT TO DESCRIBE THIS CIRCUIT THAT MEETS CUSTOMER SPECIFICATIONS. HOWEVER, IT RELIES ON THE CUSTOMER'S RESPONSIBILITY TO VERIFY PROPER AND RELIABLE OPERATION IN THE ACTUAL APPLICATION. COMPONENT SUBSTITUTION AND PRINTED CIRCUIT BOARD LAYOUT MAY SIGNIFICANTLY AFFECT CIRCUIT PERFORMANCE OR REQUIREMENT. CONTACT LINEAR TECHNOLOGY APPLICATIONS ENGINEERING FOR ASSISTANCE. THIS CIRCUIT IS PROPRIETARY TO LINEAR TECHNOLOGY AND SUPPLIED FOR USE WITH LINEAR TECHNOLOGY PARTS.

NOTE: UNLESS OTHERWISE SPECIFIED
 1. ALL RESISTORS ARE IN OHMS, 0603.
 ALL CAPACITORS ARE IN MICROFARADS, 0603.

1390 McCarty Blvd.
 Milpitas, CA 95025
 Phone: (408) 255-0000
 Fax: (408) 454-5577
 www.linear.com
 LTC Confidential/For Customer Use Only

LINEAR TECHNOLOGY

IC NO. **LTC3615EUF**
 DEMO CIRCUIT 1435A

SCALE = NONE
 SHEET 1 OF 1

X-ON Electronics

Largest Supplier of Electrical and Electronic Components

Click to view similar products for [Power Management IC Development Tools](#) category:

Click to view products by [Analog Devices](#) manufacturer:

Other Similar products are found below :

[EVAL-ADM1168LQEBZ](#) [EVB-EP5348UI](#) [MIC23451-AAAYFL EV](#) [MIC5281YMME EV](#) [DA9063-EVAL](#) [ADP122-3.3-EVALZ](#) [ADP130-0.8-EVALZ](#) [ADP130-1.2-EVALZ](#) [ADP130-1.5-EVALZ](#) [ADP130-1.8-EVALZ](#) [ADP1714-3.3-EVALZ](#) [ADP1716-2.5-EVALZ](#) [ADP1740-1.5-EVALZ](#) [ADP1752-1.5-EVALZ](#) [ADP1828LC-EVALZ](#) [ADP1870-0.3-EVALZ](#) [ADP1871-0.6-EVALZ](#) [ADP1873-0.6-EVALZ](#) [ADP1874-0.3-EVALZ](#) [ADP1882-1.0-EVALZ](#) [ADP199CB-EVALZ](#) [ADP2102-1.25-EVALZ](#) [ADP2102-1.875EVALZ](#) [ADP2102-1.8-EVALZ](#) [ADP2102-2-EVALZ](#) [ADP2102-3-EVALZ](#) [ADP2102-4-EVALZ](#) [ADP2106-1.8-EVALZ](#) [ADP2147CB-110EVALZ](#) [AS3606-DB](#) [BQ24010EVM](#) [BQ24075TEVM](#) [BQ24155EVM](#) [BQ24157EVM-697](#) [BQ24160EVM-742](#) [BQ24296MEVM-655](#) [BQ25010EVM](#) [BQ3055EVM](#) [NCV891330PD50GEVB](#) [ISLUSBI2CKIT1Z](#) [LM2744EVAL](#) [LM2854EVAL](#) [LM3658SD-AEV/NOPB](#) [LM3658SDEV/NOPB](#) [LM3691TL-1.8EV/NOPB](#) [LM4510SDEV/NOPB](#) [LM5033SD-EVAL](#) [LP38512TS-1.8EV](#) [EVAL-ADM1186-1MBZ](#) [EVAL-ADM1186-2MBZ](#)