

LTC3589

8-Output Regulator with Sequencing and I²C

DESCRIPTION

Demonstration Circuit 1558A is a multioutput power supply with a pushbutton controller and I²C, featuring the [LTC®3589EUJ](#). The LTC3589 has three synchronous buck regulators, a buck-boost regulator, an always-on LDO, and three LDO regulators. The input range of the LTC3589 is ideal for single cell Li-Ion/Polymer battery applications.

The switching regulator settings such as enables, feedback voltages, operating modes and other functions can be controlled via I²C. All of the regulators, except the always-on LDO1, can also be enabled via external enable pins. After the first regulator is enabled, the remaining enable pins use a precision threshold to allow hardwired power-up sequences. All the regulators, except LDO1, can also be enabled via the I²C.

The LTC3589 has two status registers, PGSTAT and IRQ-STAT, that can be used to determine the current state of the device.

The two status registers can be read via I²C and indicate which regulators are in regulation and if an undervoltage (UV) or overtemperature (OT) event occurred. The command registers which are used to control the switching regulators and program the special functions can also be read back via I²C to assure the correct data was received.

Refer to the LTC3589 data sheet for more details on the electrical and timing specifications.

Design files for this circuit board are available at <http://www.linear.com/demo/DC1558A>

LT, LT, LTC, LTM, Linear Technology and the Linear Logo are registered trademarks and QuikEval is a trademark of Linear Technology Corporation. All other trademarks are the property of their respective owners.

PERFORMANCE SUMMARY

Specifications are at T_A = 25°C.

SYMBOL	PARAMETER	CONDITIONS	MIN	TYP	MAX	UNITS
V _{IN}	Input Voltage Range		2.7		5.5	V
V (Buck 1)	Buck Regulator 1 Output Voltage	Buck 1 Enabled, I (Buck 1) = 0A to 1.6A	0.62	1.206	1.38	V
V (Buck 2)	Buck Regulator 2 Output Voltage	Buck 2 Enabled, I (Buck 2) = 0A to 1.0A	0.937	1.819	2.08	V
V (Buck 3)	Buck Regulator 3 Output Voltage	Buck 3 Enabled, I (Buck 3) = 0A to 1.0A	0.648	1.259	1.44	V
V (Buck-Boost)	Buck-Boost Regulator Output Voltage	Buck-Boost Enabled, I (Buck-Boost) = 0A to 1.2A	3.17	3.30	3.43	V
V (LDO1)	LDO1 Regulator Output Voltage	LDO1 Is Always On, I (LDO1) = 0A to 25mA	1.13	1.20	1.27	V
V (LDO2)	LDO2 Regulator Output Voltage	LDO2 Enabled, I (LDO2) = 0A to 200mA	0.62	1.206	1.38	V
V (LDO3)	LDO3 Regulator Output Voltage	LDO3 Enabled, I (LDO3) = 0A to 200mA	1.756	1.80	1.854	V
V (LDO4)	LDO4 Regulator Output Voltage	LDO4 Enabled, I (LDO4) = 0A to 200mA	1.746	2.80	3.399	V

QUICK START PROCEDURE

DC1558A VIN range is 2.7V to 5.5V, ideal for single cell Li-Ion/Polymer battery applications. DC1558A utilizes the DC590B, USB to I²C interface board, to control the LTC3589 and to read back the contents of the command and status registers.

The DC1558 is easy to set up to evaluate the performance of the LTC3589. Refer to Figure 1 and Figure 2 for proper measurement equipment set-up and follow the evaluation procedure below using the DC590B board.

NOTE. When measuring the input or output voltage ripple, care must be taken to avoid a long ground lead on the oscilloscope probe. Measure the input or output voltage ripple by touching the probe tip directly across the VIN or VOUT and GND terminals. See Figure 2 for proper scope probe technique.

1. Ensure that JP1 to JP3, and SW1 are in their default positions, as shown in Figure 1. Set PS1 to 5V and turn on. The RST0 LED should light until LDO1 comes on, and the PGOOD LED should come on and stay on.

NOTE. The DVCC voltage level may be selected on the DC590B. This is done by setting the VCCIO jumper, JP6, on the DC590B board to one of the following settings: 3.3V, 5V, removed for 2.7V or set to external if an external supply is desired to be used. Please set DVCC to 5V. Please refer to the documentation for the DC590B board for more information.

2. Start the Linear Technology QuikEval™ program. Download and install the latest version of the QuikEval program from the following weblink: <http://www.linear.com/designtools/software/>. The QuikEval program installs the hardware drivers for the DC590 communications board. Run the “DC1558 GUI Installer” from the LTC3589

product page located at www.linear.com/product/LTC3589. The GUI installer will place a shortcut in the start menu at location: Linear Technology Corp/demoboards/LTC3589 GUI. Click on the shortcut to start the GUI. The GUI reads back the current voltages of the regulators. LDO1 should read 1.2V, and VIN should read 5V, all others should be 0V.

3. Press the PB1 button on the DC1558A for more than 0.5s, and all of the power supplies should come up and the displayed GUI page should match Figure 3. The sequencing for these supplies was set by LTC using resistor divider networks from the supply outputs to control the ENx lines. Note: All displayed voltages are $\pm 30\text{mV}$.
4. Each of the supplies can be loaded to test the regulators, but be aware that LDO2 to LDO4 can be powered from VIN (see JP1 and JP2), on the DC1558A and the dissipation can be significant. If significant current is desired from these regulators, care in input voltage selection will be required.
5. Press and hold the PB1 button for more than 5 seconds, and all of the regulators, except LDO1, will shut down. The GUI will show the voltages for all regulators, other than always on LDO1, as 0V. LDO1 should read 1.2V and V_{IN} should read 5V.
6. Refer to the USING THE LTC3589 SOFTWARE section for more information on how to control the device using the LTC3589 control window.
7. Refer to the LTC3589 data sheet for more details on how the LTC3589 operates.
8. When done, close the LTC3589 GUI and turn off all loads and power supplies.

QUICK START PROCEDURE

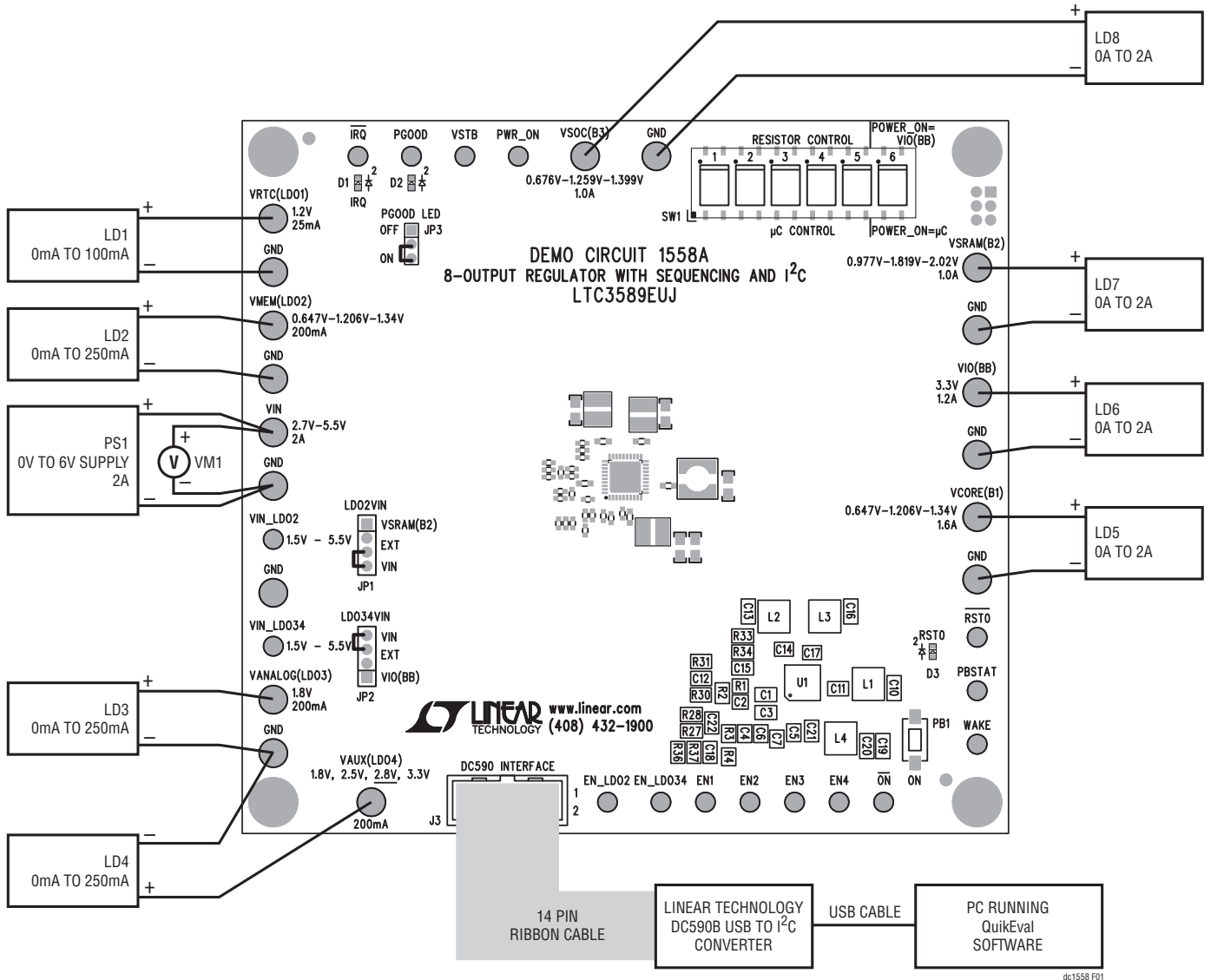

Figure 1. Proper Measurement Equipment Set-Up

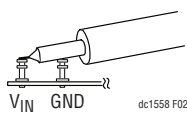

Figure 2. Measuring Input or Output Ripple

APPLICATIONS INFORMATION

The DC1558A demo board has been preconfigured to provide a power-on sequence compatible with a Freescale i.MX51 processor:

Ensure that SW1 is on Resistor Control for all switches and the GUI is in Normal Mode.

Press PB1 for more than one-half second to produce this start-up sequence:

Start-Up Sequence

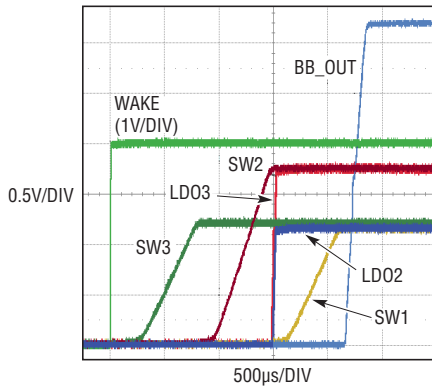

The efficiency of the switching regulators, as configured on the demo board has been measured.

Buck-Boost Efficiency vs I_{OUT}

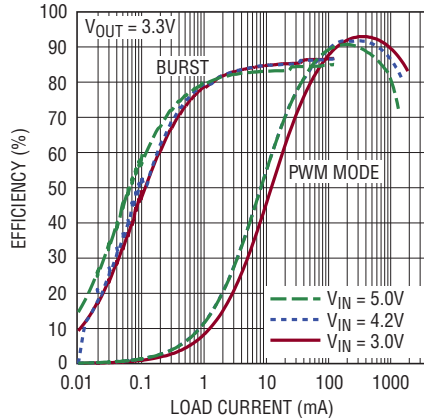

Step-Down Switching Regulator 1 Efficiency vs I_{OUT}

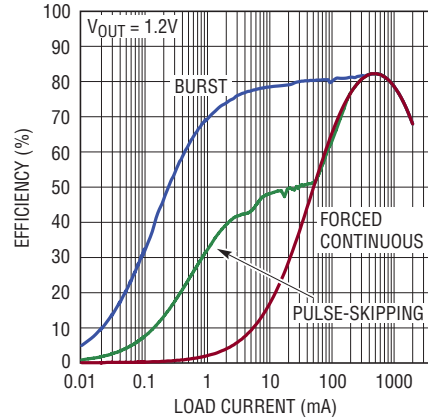

Step-Down Switching Regulator 2 Efficiency vs I_{OUT}

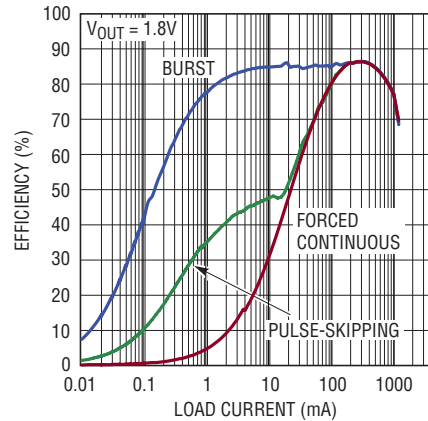

Step-Down Switching Regulator 3 Efficiency vs I_{OUT}

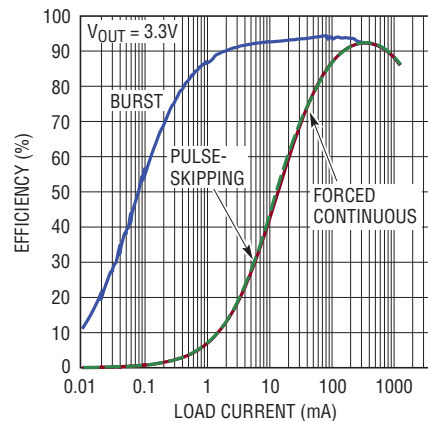

USING THE DC1558A SOFTWARE

Introduction

The LTC3589EUJ GUI provides control of most aspects of operation of the LTC3589EUJ. The LTC3589EUJ GUI also provides a means to manage the feedback divider resistors, turn the regulators on and off manually, and even to experiment with sequencing.

Ensure that the QuikEval software is installed on the computer. It can be downloaded from www.linear.com/designtools/software/. Download and install the LTC3589EUJ GUI from the product page at the Linear Technology website www.linear.com/product/LTC3589.

The LTC3589EUJ GUI is composed of four forms, the LTC3589 Form (Figure 3) that is brought up by the QuikEval program. The Manage feedback divider resistor values Form (Figure 4), that is brought up by pressing the “Change Resistor Divider Networks” button on the LTC3589 Form. The Advanced Settings form (Figure 5), that is brought up by pressing the “Advanced Settings” button on the LTC3589 Form. The Sequencing Form that is brought up by pressing the “Change LTC3589 Sequencing” button.

The Sequencing form in turn contains two tabs: Direct (Figure 6) and Table (Figure 7). These allow Direct control and Table based sequencing respectively.

SW1, positions 1 to 5, sets the source of the EN signals to the preselected resistor networks or to the onboard microcontroller. SW1, positions 1 to 5, should be set to the Resistor Control for Normal mode, and μ C Control for Sequence modes (Direct and Table).

SW1 position 6 controls the source of PWR_ON. Resistor Control makes the source the Buck-Boost regulator output. μ C Control makes it controlled by the onboard microcontroller. This switch should be set to Resistor Control for Normal mode and μ C Control for Sequence modes.

View LTC3589EUJ Product Page

This button opens your default internet browser, and searches the Linear Technology Corporation website for information on the LTC3589EUJ when an internet connection is available.

Buck1 to Buck3, Buck-Boost, and LDO2 to LDO4 Sections

These sections control most aspects of the regulator operation. Some of the controls for these regulators are on the Advanced Settings Form. Please consult the LTC3589 data sheet for operation of these bits.

In the Buck1 to Buck3, and LDO2 sections, there is a button labeled Go. Whenever the DAC sliders are changed or the regulator is switched between Normal and Standby, the appropriate control registers are changed. But, the LTC3589 will wait for the Go button to be pressed before going to the new voltage.

If the textbox has a grey background, it cannot be directly edited. A good example of this is the command registers SCR1, OVEN, SCR2, etc at the bottom of the LTC3589 form. These registers are changed by the various controls on the form.

The “Auto ReadBack Enabled” button determines if the IRQSTAT and PGSTAT values are automatically readback. If automatic readback is disabled, the “Readback” button will do a one time readback.

The “Auto Update Enabled” button determines if the command registers are automatically sent to the LTC3589 on change, and if the values of these registers are automatically readback. If automatic update is disabled, the “Update All button” will update all the command registers and readback the values.

For all the automatic update modes, an internal 100ms timer is used, so all values will be updated every 100ms, if enabled.

Interrupts and Status

The current state of IRQSTAT and PGSTAT are displayed on the right. If an interrupt is pending the IRQ LED (D1) on the DC1558 demo board will light. Interrupt box will change color to red, and display “Interrupt Pending”. To clear the interrupt press the “Clear Interrupt” button.

USING THE DC1558A SOFTWARE

Advanced Settings Button

This button brings up the Advanced Settings Form (Figure 5), which allows control of several less used bits. Any changes made in this form will be immediately reflected in the appropriate command registers, on the LTC3589 Form. However, if auto-update is disabled the value will not be sent to the LTC3589 until auto update is re-enabled or the “Update All” button is pressed.

Mode Display

This box displays the current operating mode. The value of this box can be changed in the Sequence form.

Load Factory Defaults

The factory default values for the command registers, regulator resistors and auto update states, are immediately loaded.

Load Stored Values

The state of the command registers, regulator resistors, and auto update states, can be saved to a file, and reused. This button causes the saved states to be loaded immediately.

Save Current Values

Immediately saves the state of the command registers, regulator resistors, and autoupdate states to file.

Start-Up

The Start-Up section determines what the GUI will do at startup, load default or stored command register, regulator resistors and autoupdate states, from file.

Shutdown

The Shutdown section determines what the GUI will do at shutdown, store the current command register, regulator resistor resistors and autoupdate values to file, or not.

Change Resistor Divider Networks Button

This button brings up the Manage feedback divider resistor values form (Figure 4), which allows of the feedback divider resistor values. Any changes made in this form will be immediately reflected in the appropriate voltage value

boxes, on the LTC3589 Form. It is the user’s responsibility to ensure that the values in this form are the same as the values of the actual resistors on the demo board.

Change LTC3589 Sequencing Button

This brings up the Sequencing form, which has two tabs Direct (Figure 6) and Table (Figure 7). These allow the direct control of the regulator on/off (Direct tab) or setup a sequence that will be downloaded to the onboard microcontroller to set the regulator sequencing (Table tab).

Both the Direct and the Table modes require that all positions of the SW1 dipswitch be in the μ C Control position.

Neither Direct nor Sequence mode can be enabled from the other mode. You must be in Normal mode to enable Direct or Sequence mode. Sequence mode will automatically return to Normal mode on sequence completion.

Returning to Normal mode explicitly, by using a button to disable Direct or Sequence modes, resets the regulator states to the default. However, if you return to normal mode by completing a downloaded sequence, the regulator states are not reset.

Direct

To directly control the on/off state of the regulators, choose the Direct tab, enable Direct mode (the mode display on the LTC3589 form should change to Direct. Ensure that the dipswitch positions are in the correct state, and check the appropriate boxes. The regulators can now be turned on and off directly.

The Measured Voltage boxes are live and updated on the 100ms update timer.

Table

To set up a sequence for the power supplies to power up, choose the Table tab. Do not enable Sequence mode until a Sequence Table has been downloaded. Sequence Tables can only be downloaded in Normal mode.

Some error checking is done on the table before downloading, such as ensuring that at least one regulator is controlled by WAKE, but in general the user must ensure that the Sequence Table is reasonable.

USING THE DC1558A SOFTWARE

In particular, always ensure that one regulator is controlled by WAKE and that at least one regulator, that is used in the particular sequence controls PWR_ON. It is not necessary that you use neither all regulators, nor that only one regulator is controlled at a time. For example, WAKE could start all regulators, or just one. If PWR_ON is not asserted in the sequence, the sequence will execute, but then the regulators will shutdown after 5 seconds.

Once a sequence has been downloaded, and Sequence mode set, press the PB1 button to start the sequence.

The level of the WAKE signal is the same as the level of the VIN signal, that is if VIN is 3V, WAKE will assert at 3V. So when choosing the threshold voltage for WAKE make

sure that you do not set it higher than the VIN voltage. In fact, you should choose a voltage that is \approx VIN/2.

When PWR_ON is asserted in the sequence, the onboard microcontroller determines that the sequence is done and sets the state to normal (without resetting the states of the regulators). The Sequence Table form can now be closed. If you wish to rerun the sequence, hold down PB1 for more than 5 seconds, until the regulators shut off. Go to the Sequence Table form, and enable Sequence mode. It is not necessary to download the sequence table again, as it is still in the onboard microcontroller's memory. Now, just press the PB1 button to restart the sequence.

The screenshot shows the LTC3589 software interface with the following sections:

- Header:** "LTC3589" title bar, "LINEAR TECHNOLOGY" logo, "VIEW LTC3589 PRODUCT PAGE" checkbox, "No Interrupt Pending" status, and "Clear Interrupt" button.
- Regulator Settings (Columns 1-8):** Buck1, Buck2, Buck3, Buck Boost, LDO1, LDO2, LDO3, LDO4. Each column includes:
 - Mode selection (Pulse Skip, Burst, Continuous).
 - Normal/Standby (NORM | STBY) tabs.
 - Normal Nominal Voltage (e.g., 1.205 V, 1.818 V, 1.259 V, 3.33 V, 1.2 V, 1.205 V, 1.800 V, 2.8 V).
 - Normal Vref (e.g., 675 mV, 800 mV, 800 mV, 675 mV).
 - Norm/Stby Go buttons.
 - Measured Voltage (e.g., 1.22 V, 1.81 V, 1.26 V, 3.36 V, 1.22 V, 1.22 V, 1.79 V, 2.8 V).
 - Dynamic Slew Rate (e.g., 7mV/µs).
 - Frequency (e.g., 2.25MHz).
 - Phase (e.g., Phase 1).
- IRQSTAT and PGSTAT (Right Side):**
 - IRQSTAT: TSD = 0, HOT = 0, UVLO = 0, Near UV = 0, PGSD = 0, Disused, Disused.
 - PGSTAT: LDO4 PG =, LDO3 PG =, LDO2 PG =, B-B PG = 1, Buck1 PG =, Buck2 PG =, Buck3 PG =, LDO1 PG =.
- Advanced Settings:** "Advanced Settings" button, "Measured Vin Voltage" (5.02 V), "Status Registers" (Readback, Auto Readback Enabled), "Command Registers" (Update All, Auto Update Enabled).
- Registers Table:**

	SCR1	OVEN	SCR2	VCCR	B1DTV1	B1DTV2	VRRCR	B2DTV1	B2DTV2	B3DTV1	B3DTV2	L2DTV1	L2DTV2
WRITE	00	00	00	00	19	19	FF	19	19	19	19	19	19
READ	00	00	00	00	19	19	FF	19	19	19	19	19	19
- Buttons:** "Load Factory Defaults", "Load Stored Values", "Save Current Values", "Startup" (Load Stored, Load Default), "Shutdown" (Store Current, Store None), "Change Resistor Divider Networks", "Change LTC3589 sequencing", "Normal Mode".

Figure 3. Main Form

USING THE DC1558A SOFTWARE

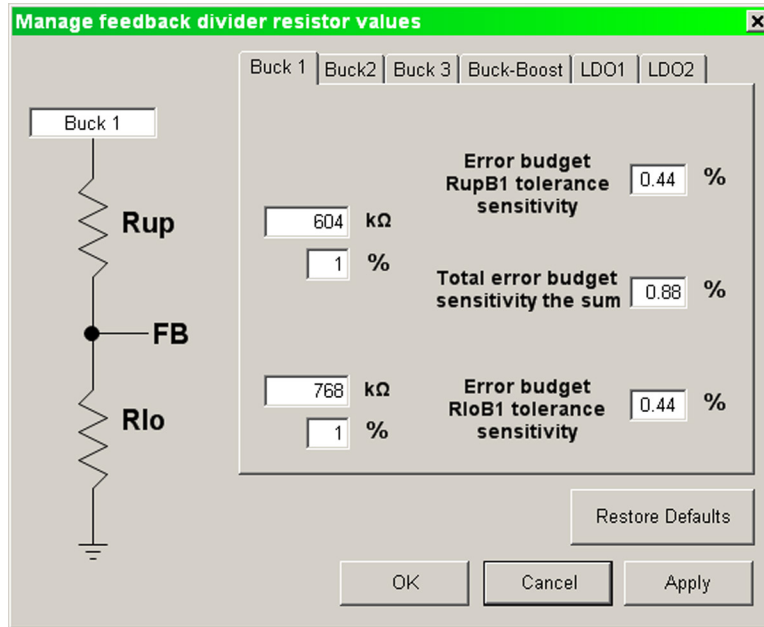

Figure 4. Manage Resistors Form

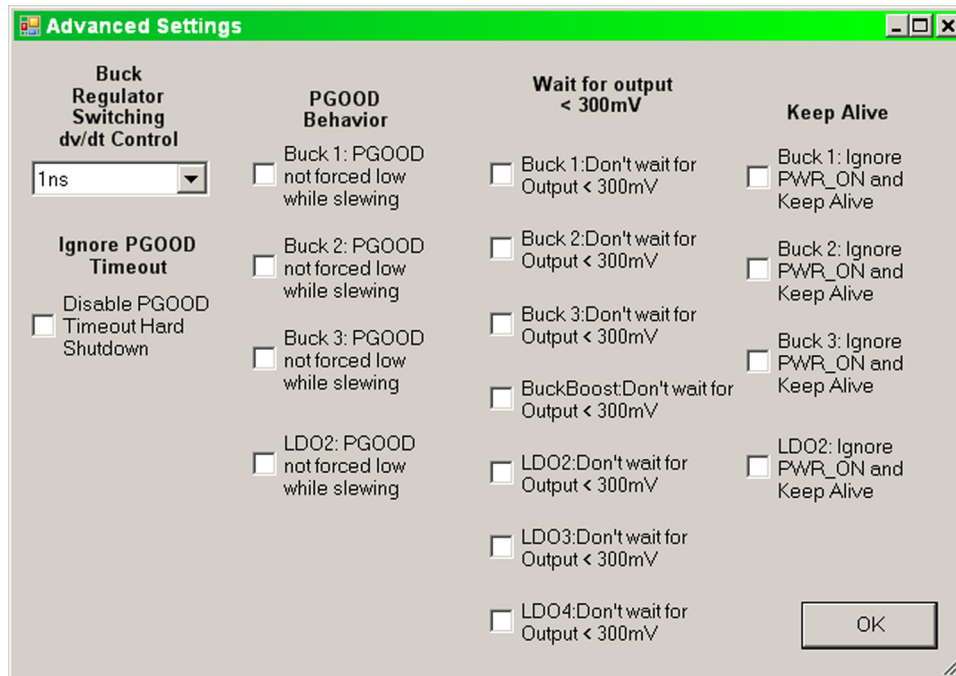

Figure 5. Advanced Settings Form

USING THE DC1558A SOFTWARE



Figure 6.

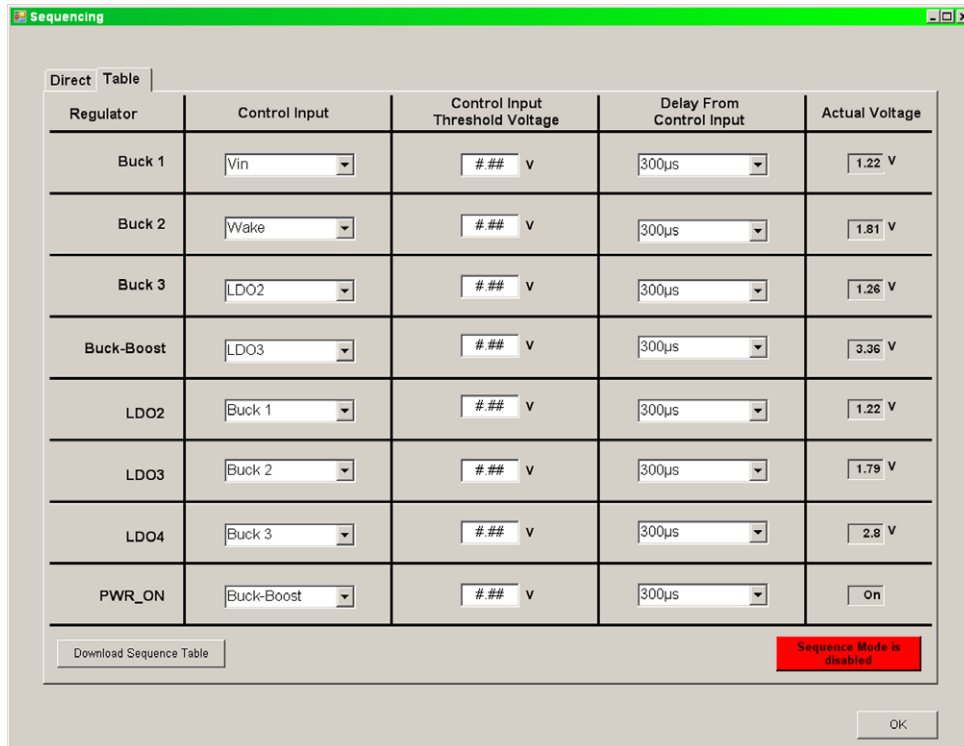

Figure 7.

DEMO MANUAL DC1558A

PARTS LIST

ITEM	QUANTITY	REFERENCE	DESCRIPTION	MANUFACTURER/PART NUMBER
Required Circuit Components:				
1	5	C1, C11, C14, C17, C21	CAP, CHIP X5R, 10 μ F, \pm 20%, 6.3V, 0603	TDK, C1608X5R0J106M
2	6	C2, C3, C4, C5, C6, C7	CAP, CHIP, X5R, 1 μ F, \pm 10%, 10V, 0402	MURATA, GRM155R61A105KE15D
3	5	C10, C13, C16, C19, C20	CAP, CHIP, X5R, 22 μ F, \pm 20%, 6.3V, 0805	TAIYO-YUDEN, JMK212BJ226MG
4	3	C12, C15, C18	CAP, CHIP, COG, 10pF, \pm 0.5pF, 50V, 0402	VISHAY, VJ0402A100
5	1	C22	CAP, CHIP, COG, 4.7pF, \pm 0.5pF, 50V, 0402	VISHAY, VJ0402A4R7
6	1	L1	IND, SMT, 2.7 μ H, 47m Ω , \pm 30%, 2.20A 4.8mm \times 4.8mm	WURTH, 7440420027
7	2	L2, L3	IND, SMT, 1.5 μ H, 36m Ω , \pm 20%, 5.8A, 4.2mm \times 4.2mm	COILCRAFT, XPL4020-152ML
8	1	L4	IND, SMT, 1.0 μ H, 29m Ω , \pm 20%, 6.5A, 4.2mm \times 4.2mm	COILCRAFT, XPL4020-102ML
9	2	R1, R55	RES, CHIP, 511k, \pm 1%, 1/16W, 0402	VISHAY, CRCW0402511KFKED
10	1	R2	RES, CHIP, 1.02M Ω , \pm 1%, 1/16W, 0402	VISHAY, CRCW04021M02FKED
11	2	R3, R37	RES, CHIP, 604k, \pm 1%, 1/16W, 0402	VISHAY, CRCW0402604KFKED
12	2	R4, R36	RES, CHIP, 768k, \pm 1%, 1/16W, 0402	VISHAY, CRCW0402768KFKED
13	1	R27	RES, CHIP, 316k, \pm 1%, 1/16W, 0402	VISHAY, CRCW0402316KFKED
14	1	R28	RES, CHIP, 1M Ω , \pm 1%, 1/16W, 0402	VISHAY, CRCW04021M00FKED
15	4	R29, R32, R35, R38	RES, CHIP, 20 Ω , \pm 5%, 1/16W, 0402	VISHAY, CRCW040220R0JNED
16	1	R30	RES, CHIP, 787k, \pm 1%, 1/16W, 0402	VISHAY, CRCW0402787KFKED
17	1	R31	RES, CHIP, 681k, \pm 1%, 1/16W, 0402	VISHAY, CRCW0402681KFKED
18	1	R33	RES, CHIP, 422k, \pm 1%, 1/16W, 0402	VISHAY, CRCW0402422KFKED
19	1	R34	RES, CHIP, 715k, \pm 1%, 1/16W, 0402	VISHAY, CRCW0402715KFKED
20	9	R43, R45, R47, R49, R50, R51, R53, R57, R58	RES, CHIP, 10k, \pm 1%, 1/16W, 0402	VISHAY, CRCW040210K0FKED
21	3	R44, R46, R54	RES, CHIP, 18.2k, \pm 1%, 1/16W, 0402	VISHAY, CRCW040218K2FKED
22	2	R48, R52	RES, CHIP, 9.09k, \pm 1%, 1/10W, 0402	VISHAY, CRCW04029K09FKED
23	1	U1	8 – OUTPUT REGULATOR WITH SEQUENCING AND I ² C	LINEAR TECHNOLOGY, LTC3589EUJ
Additional Demo Board Circuit Components:				
1	4	C8, C9, C25, C27	CAP, CHIP, X7R, 0.1 μ F, \pm 10%, 16V, 0402	MURATA, GRM155R71C104KA88S
2	2	C26, C28	CAP, CHIP, COG, 1000pF, \pm 5%, 50V, 0402	TDK, GRM1555C1H102J
3	2	C23, C24	CAP, CHIP, X5R, 2.2 μ F, \pm 20%, 6.3V, 0402	MURATA, GRM155R60J225ME15D
4	2	D1, D3	DIODE, LED, RED, SMT, 0603	PANASONIC, LNJ208R8ARA
5	1	D2	LED, AMBER HIGH BRIGHT ESS SMD, 0603	PANASONIC, LNJ436W82RA
6	1	D4	DIODE, SCHOTTKY, SMT, 20V, 0.5A, SOD123	ON SEMICONDUCTOR, MBR0520LG
7	1	D5	DIODE, SI SWITCHING, 100V, 80mA, SOD123	ON SEMICONDUCTOR, MMSD4148G
8	1	M1	MOSFET, 60V, 10 Ω , 115A, SOT-23	FAIRCHILD, 2N7002L
9	1	PB1	SWITCH, SMT, N.O. MOMENTARY, 3.5mm \times 6mm	PANASONIC, EVQPPFA25
10	1	Q1	BITRANS., GP SS NPN 40V, SOT-23	ON SEMICONDUCTOR, MMBT3904LG
11	4	R5, R10, R39, R56	RES, CHIP, 1k, \pm 5%, 1/16W, 0402	VISHAY, CRCW04021K00JNED
12	5	R6, R7, R8, R9, R40	RES, CHIP, 100k, \pm 5%, 1/16W, 0402	VISHAY, CRCW0402100KJNED
13	11	R11, R12, R13, R14, R15, R16, R17, R18, R19, R20, R21	RES, CHIP, 10k, 5%, 1/16W, 0402	VISHAY, CRCW040210K0JNED

PARTS LIST

ITEM	QUANTITY	REFERENCE	DESCRIPTION	MANUFACTURER/PART NUMBER
14	3	R22, R23, R25	RES, CHIP, 5.1k, 5%, 1/16W, 0402	VISHAY, CRCW04025K10JNED
15	2	R24, R26	RES, CHIP, 4.7k, ±5%, 1/16W, 0402	VISHAY, CRCW04024K70JNED
16	2	R41, R42	RES, CHIP, 100k, ±1%, 1/16W, 0402	VISHAY, CRCW0402100KFED
17	1	SW1	SWITCH, SMT, SPDT, 6 POS. DIP, 37mm × 8mm	CTS ELECTROCOMPONENTS, 204-126-LPS
18	1	U2	I ² C EEPROM	MICROCHIP, 24LC025-I/ST
19	1	U3	PIC MICROCONTROLLER, 6mm × 6mm QFN16	MICROCHIP, PIC16F722-I/ML
20	1	U4	LOW NOISE REGULATED CHARGE PUMP IN 2mm × 2mm DFN	LINEAR TECHNOLOGY, LTC3204BEDC-5

Hardware for Demo Board Only:

1	18	E1 TO E4, E6, E7, E9 TO E12, E27 TO E34	TURRET, 0.09 DIA	MILL-MAX, 2501-2-00-80-00-00-07-0
2	16	E5, E8, E13 TO E26	TURRET, 0.061 DIA	MILL-MAX, 2308-2-00-80-00-00-07-0
3	1	J2	HEADER, 2mm × 3mm, 0.079 DOUBLE ROW	SAMTEC, TMM-103-02-L-D
4	1	J3	CONN, HEADER 14POS 2mm VERT GOLD	MOLEX, 87831-1420
5	2	JP1, JP2	HEADER, 1mm × 4mm PIN 0.079 SINGLE ROW	SAMTEC, TMM-104-02-L-S
6	1	JP3	HEADER, 1mm × 3mm PIN 0.079 SINGLE ROW	SAMTEC, TMM-103-02-L-S
7	3	JP1 to JP3	SHUNT, 0.079" CENTER	SAMTEC, 2SN-KB-G
8	4		STAND-OFF, NYLON, 0.375" TALL (SNAP ON)	KEYSTONE, 8832 (SNAP ON)
9	1		FAB, PRINTED CIRCUIT BOARD	DEMO CIRCUIT 1558A
10	2		STENCIL – TOP & BOTTOM	STENCIL #1558A-TOP & BOTTOM

DEMO MANUAL DC1558A

SCHEMATIC DIAGRAM

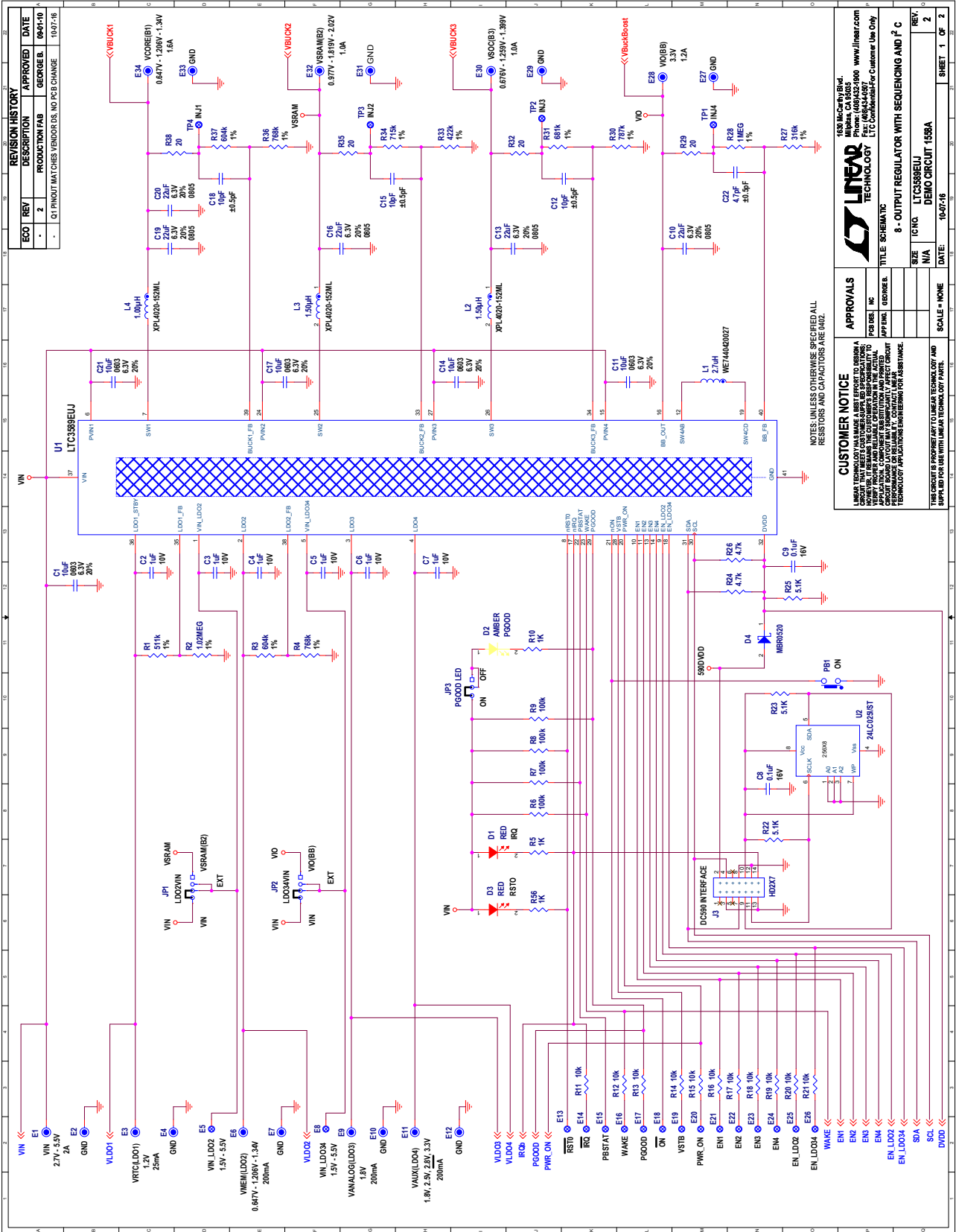

dc1558afb

SCHEMATIC DIAGRAM

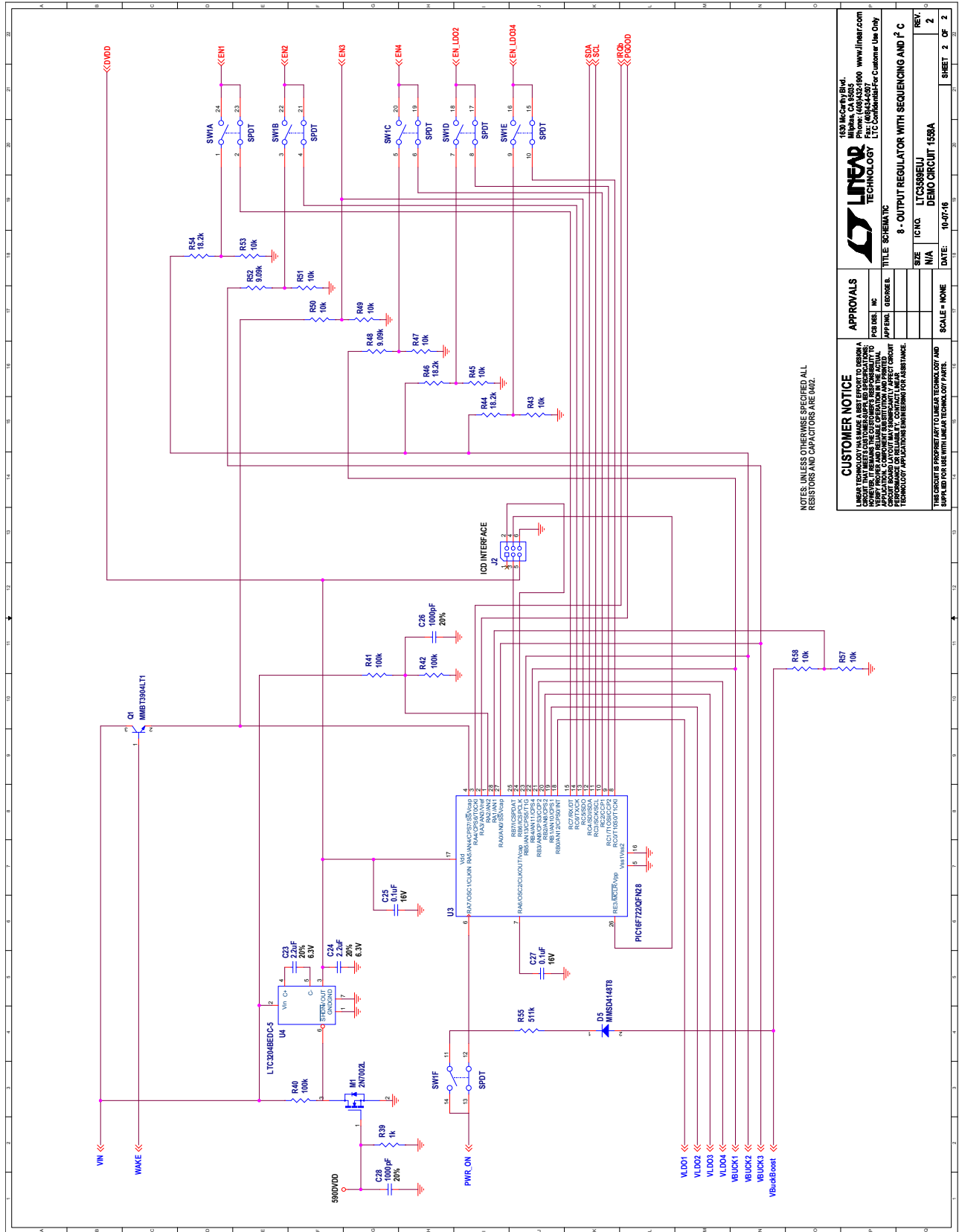

NOTES: UNLESS OTHERWISE SPECIFIED ALL RESISTORS AND CAPACITORS ARE IN Ω.

CUSTOMER NOTICE
 LINEAR TECHNOLOGY MAKES A BEST EFFORT TO DESIGN A CIRCUIT THAT MEETS CUSTOMER SUPPLIED OPERATING CONDITIONS. CUSTOMER SHOULD VERIFY PROPER AND RELIABLE OPERATION IN THE ACTUAL APPLICATION. CUSTOMER SHOULD VERIFY THAT THE ACTUAL CIRCUIT BOARD LAYOUT MAY INADEQUATELY AFFECT CIRCUIT PERFORMANCE. LINEAR TECHNOLOGY ASSUMES NO LIABILITY FOR ASSISTANCE.

APPROVALS
 DESIGNED BY: _____
 APPROVED BY: _____

LINEAR TECHNOLOGY
 1630 McCarty Blvd.
 Milpitas, CA 95035
 Tel: (415) 964-8000 www.linear.com
 Fax: (415) 964-8007
 LTC Confidential For Customer Use Only

8 - OUTPUT REGULATOR WITH SEQUENCING AND PFC
 DEMO CIRCUIT 1558A

DATE: 10-07-16 SCALE: NONE SHEET 2 OF 2



Information furnished by Linear Technology Corporation is believed to be accurate and reliable. However, no responsibility is assumed for its use. Linear Technology Corporation makes no representation that the interconnection of its circuits as described herein will not infringe on existing patent rights.

DEMO MANUAL DC1558A

DEMONSTRATION BOARD IMPORTANT NOTICE

Linear Technology Corporation (LTC) provides the enclosed product(s) under the following **AS IS** conditions:

This demonstration board (DEMO BOARD) kit being sold or provided by Linear Technology is intended for use for **ENGINEERING DEVELOPMENT OR EVALUATION PURPOSES ONLY** and is not provided by LTC for commercial use. As such, the DEMO BOARD herein may not be complete in terms of required design-, marketing-, and/or manufacturing-related protective considerations, including but not limited to product safety measures typically found in finished commercial goods. As a prototype, this product does not fall within the scope of the European Union directive on electromagnetic compatibility and therefore may or may not meet the technical requirements of the directive, or other regulations.

If this evaluation kit does not meet the specifications recited in the DEMO BOARD manual the kit may be returned within 30 days from the date of delivery for a full refund. **THE FOREGOING WARRANTY IS THE EXCLUSIVE WARRANTY MADE BY THE SELLER TO BUYER AND IS IN LIEU OF ALL OTHER WARRANTIES, EXPRESSED, IMPLIED, OR STATUTORY, INCLUDING ANY WARRANTY OF MERCHANTABILITY OR FITNESS FOR ANY PARTICULAR PURPOSE. EXCEPT TO THE EXTENT OF THIS INDEMNITY, NEITHER PARTY SHALL BE LIABLE TO THE OTHER FOR ANY INDIRECT, SPECIAL, INCIDENTAL, OR CONSEQUENTIAL DAMAGES.**

The user assumes all responsibility and liability for proper and safe handling of the goods. Further, the user releases LTC from all claims arising from the handling or use of the goods. Due to the open construction of the product, it is the user's responsibility to take any and all appropriate precautions with regard to electrostatic discharge. Also be aware that the products herein may not be regulatory compliant or agency certified (FCC, UL, CE, etc.).

No License is granted under any patent right or other intellectual property whatsoever. **LTC assumes no liability for applications assistance, customer product design, software performance, or infringement of patents or any other intellectual property rights of any kind.**

LTC currently services a variety of customers for products around the world, and therefore this transaction **is not exclusive**.

Please read the DEMO BOARD manual prior to handling the product. Persons handling this product must have electronics training and observe good laboratory practice standards. **Common sense is encouraged.**

This notice contains important safety information about temperatures and voltages. For further safety concerns, please contact a LTC application engineer.

Mailing Address:

Linear Technology
1630 McCarthy Blvd.
Milpitas, CA 95035

Copyright © 2004, Linear Technology Corporation

X-ON Electronics

Largest Supplier of Electrical and Electronic Components

Click to view similar products for [Power Management IC Development Tools](#) category:

Click to view products by [Analog Devices](#) manufacturer:

Other Similar products are found below :

[EVAL-ADM1168LQEBZ](#) [EVB-EP5348UI](#) [MIC23451-AAAYFL EV](#) [MIC5281YMME EV](#) [DA9063-EVAL](#) [ADP122-3.3-EVALZ](#) [ADP130-0.8-EVALZ](#) [ADP130-1.2-EVALZ](#) [ADP130-1.5-EVALZ](#) [ADP130-1.8-EVALZ](#) [ADP1714-3.3-EVALZ](#) [ADP1716-2.5-EVALZ](#) [ADP1740-1.5-EVALZ](#) [ADP1752-1.5-EVALZ](#) [ADP1828LC-EVALZ](#) [ADP1870-0.3-EVALZ](#) [ADP1871-0.6-EVALZ](#) [ADP1873-0.6-EVALZ](#) [ADP1874-0.3-EVALZ](#) [ADP1882-1.0-EVALZ](#) [ADP199CB-EVALZ](#) [ADP2102-1.25-EVALZ](#) [ADP2102-1.875EVALZ](#) [ADP2102-1.8-EVALZ](#) [ADP2102-2-EVALZ](#) [ADP2102-3-EVALZ](#) [ADP2102-4-EVALZ](#) [ADP2106-1.8-EVALZ](#) [ADP2147CB-110EVALZ](#) [AS3606-DB](#) [BQ24010EVM](#) [BQ24075TEVM](#) [BQ24155EVM](#) [BQ24157EVM-697](#) [BQ24160EVM-742](#) [BQ24296MEVM-655](#) [BQ25010EVM](#) [BQ3055EVM](#) [NCV891330PD50GEVB](#) [ISLUSBI2CKIT1Z](#) [LM2744EVAL](#) [LM2854EVAL](#) [LM3658SD-AEV/NOPB](#) [LM3658SDEV/NOPB](#) [LM3691TL-1.8EV/NOPB](#) [LM4510SDEV/NOPB](#) [LM5033SD-EVAL](#) [LP38512TS-1.8EV](#) [EVAL-ADM1186-1MBZ](#) [EVAL-ADM1186-2MBZ](#)