

LTC3838EUHF

High Efficiency Dual Output Step-Down DC/DC Converter

DESCRIPTION

Demonstration circuit 1801A is a dual output 1.5V/20A and 1.2V/20A synchronous buck converter operating with a switching frequency of 300kHz over an input voltage range of 4.5V to 14V. The demo board comes in two versions. The A version uses inductor DCR current sensing for high efficiency. The B version uses 2mΩ sense resistor for accurate current sensing with a low DCR ferrite inductor. The fixed on-time valley current mode topology of the LTC3838 allows for a fast load step response (see Figures 6 to 9). The load step response can be tested with the onboard load step circuit and a bench pulse generator.

The demo board uses a high density, two sided drop in layout. The entire converter, excluding the bulk output and input capacitors, fits within a compact 1.5" × 1.0" area on the board. The package style for the LTC3838EUHF is a 38-pin QFN with an exposed ground pad.

The main features of the board are listed below:

- MODE jumper to program either discontinuous mode (DCM) or forced continuous mode (FCM) at light or no load.
- EXTVCC pin.
- PLLIN pin to synchronize the converter to an external clock.
- Remote sensing for V_{OUT1} .
- Optional resistors to tie the two phases together.
- Each rail has its own RUN pin, PGOOD pin and TRACK/SS pin.

Design files for this circuit board are available at <http://www.linear.com/demo>

LT, LT, LTC, LTM, Linear Technology and the Linear logo are registered trademarks of Linear Technology Corporation. All other trademarks are the property of their respective owners.

PERFORMANCE SUMMARY ($T_A = 25^\circ\text{C}$)

PARAMETER	CONDITIONS	VALUE
Minimum Input Voltage		4.5V
Maximum Input Voltage		14V
Output Voltage V_{OUT1}	$I_{OUT1} = 0\text{A to } 20\text{A}, V_{IN} = 4.5\text{V to } 14\text{V}$	$1.2\text{V} \pm 2\%$
Output Voltage V_{OUT2}	$I_{OUT2} = 0\text{A to } 20\text{A}, V_{IN} = 4.5\text{V to } 14\text{V}$	$1.5\text{V} \pm 2\%$
V_{OUT1} Maximum Output Current, I_{OUT1}	$V_{IN} = 4.5\text{V to } 14\text{V}, V_{OUT1} = 1.2\text{V}$	20A
V_{OUT2} Maximum Output Current, I_{OUT2}	$V_{IN} = 4.5\text{V to } 14\text{V}, V_{OUT2} = 1.5\text{V}$	20A
Nominal Switching Frequency		300kHz
-A Efficiency (DCR Current Sense)	$V_{OUT1} = 1.2\text{V}, I_{OUT1} = 20\text{A}, V_{IN} = 12\text{V}$	91% Typical
See Figures 2 and 3	$V_{OUT2} = 1.5\text{V}, I_{OUT2} = 20\text{A}, V_{IN} = 12\text{V}$	92% Typical
-B Efficiency (R_{SENSE} Current Sense)	$V_{OUT1} = 1.2\text{V}, I_{OUT1} = 20\text{A}, V_{IN} = 12\text{V}$	89.5% Typical
See Figures 4 and 5	$V_{OUT2} = 1.5\text{V}, I_{OUT2} = 20\text{A}, V_{IN} = 12\text{V}$	91% Typical

QUICK START PROCEDURE

Demonstration circuit 1801A is easy to set up to evaluate the performance of the LTC3838EUHF. Please refer to Figure 1 for proper measurement equipment setup and follow the procedure below.

- 1) With power off, connect the input supply, load and meters as shown in Figure 1. Preset the load to 0A and V_{IN} supply to be 0V. Place jumpers in the following positions:

JP4	RUN1	ON
JP1	RUN2	ON
JP3	MODE	FCM

- 2) Adjust the input voltage to be between 4.5V to 14V. V_{OUT1} should $1.2V \pm 2\%$.

V_{OUT2} should $1.5V \pm 2\%$.

- 3) Next, apply 20A load and recheck V_{OUT} .
- 4) Once the DC regulation is confirmed, observe the output voltage ripple, load step response, efficiency and other parameters.

Note 1. Use the BNC connectors labeled V_{OUT1} or V_{OUT2} to measure the output voltage ripple.

Note 2. Do not apply the load from the $VO1_SNS^+$ turret to the $VO1_SNS^-$ turret or from the $VO2^+$ turret to the $VO2^-$ turret. These turrets are only intended to moni-

tor the voltage across $COUT1$ and $COUT5$ respectively. Heavy load currents applied across these turrets may damage the converter.

LOAD STEP TRANSIENT TESTING

Demonstration circuit 1801A provides a simple load step circuit consisting of a MOSFET and sense resistor for each rail. To apply a load step, follow the steps below.

- 1) Preset the amplitude of a pulse generator to 0.0V and the duty cycle to 5% or less.
- 2) Connect the scope to the $VOUT$ BNC connectors for the rail under test with a coax cable. To monitor the load step current, connect the scope probe across the $I_{STEP}^{+/-}$ turrets for that rail.
- 3) Connect the output of the pulse generator to the PULSE GEN turret for the rail under test and connect the return to one of the GND turrets.
- 4) With the converter running, slowly increase the amplitude of the pulse generator output to provide the desired load step pulse height. The scaling for the LOAD STEP signal is 10mV/Amp.

QUICK START PROCEDURE

A single output/dual phase converter may be preferred for high output current applications. The benefits of single output/dual phase operation is lower ripple current through the input and output capacitors, faster load step response and simplified thermal design. To implement single output/dual phase operation, make the following modifications:

- Tie V_{OUT1} to V_{OUT2} by tying together the exposed copper pads on the V_{OUT} shapes with pieces of heavy copper foil.
- Tie $VFB2$ to $INTVCC$ by stuffing 0Ω at R1. This will disable the error amp for phase-2 and internally tie the two ITH signals together.

- Remove the ITH compensation network, VFB divider and TRACK/SS capacitor for phase-2.
- Tie $VRNG1$ to $VRNG2$ by stuffing 0Ω at R4.
- Tie $RUN1$ to $RUN2$ by stuffing 0Ω at R7.
- If the optional transient detect circuit is used, externally tie the $DTR1$ pin to the $DTR2$ pin.
- Recompensate if necessary.

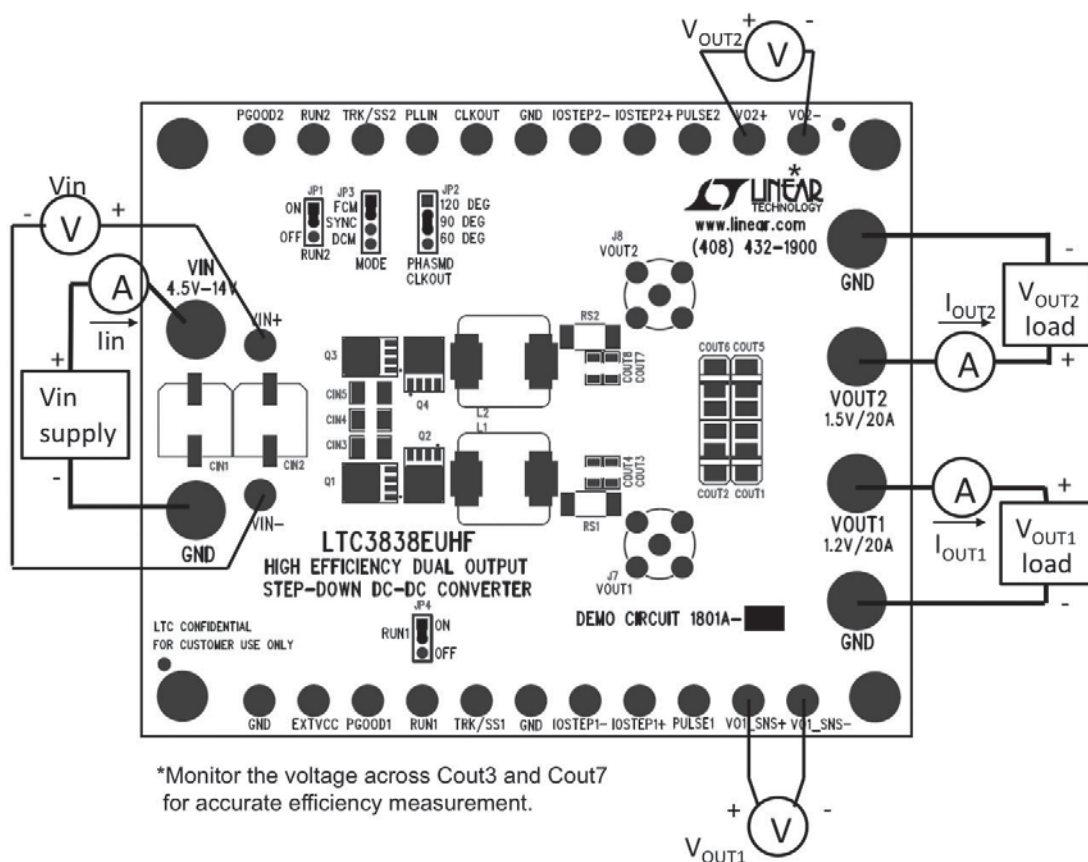
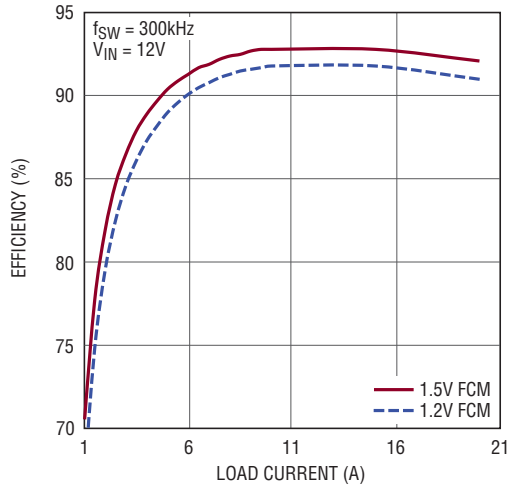

Figure 1. Proper Measurement Equipment Setup

QUICK START PROCEDURE



DC1801a F02

Figure 2. Efficiency Curves for the DC1801A-A (DCR_{SENSE}) in FCM

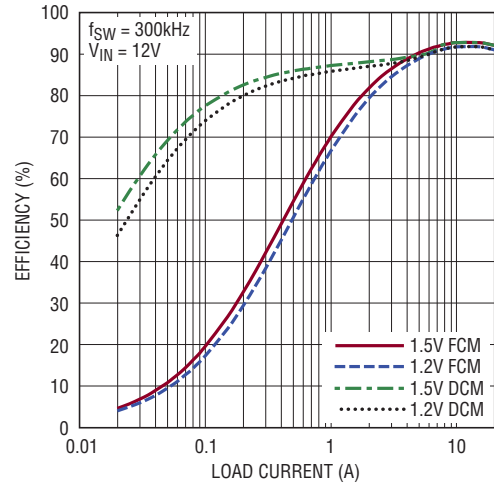

DC1801a F03

Figure 3. Efficiency Curves for the DC1801A-A (DCR_{SENSE}) in FCM and DCM.

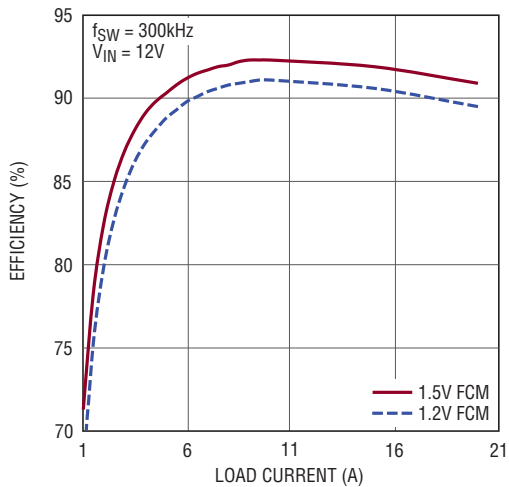

DC1801a F04

Figure 4. Efficiency Curves for the DC1801A-B (R_{SENSE}) in FCM

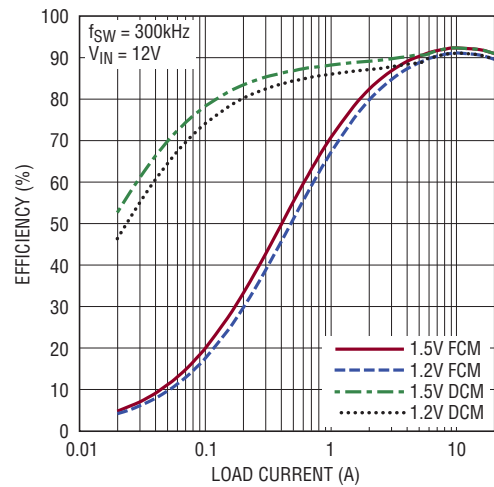

DC1801a F05

Figure 5. Efficiency Curves for the DC1801A-B (R_{SENSE}) in FCM and DCM

QUICK START PROCEDURE

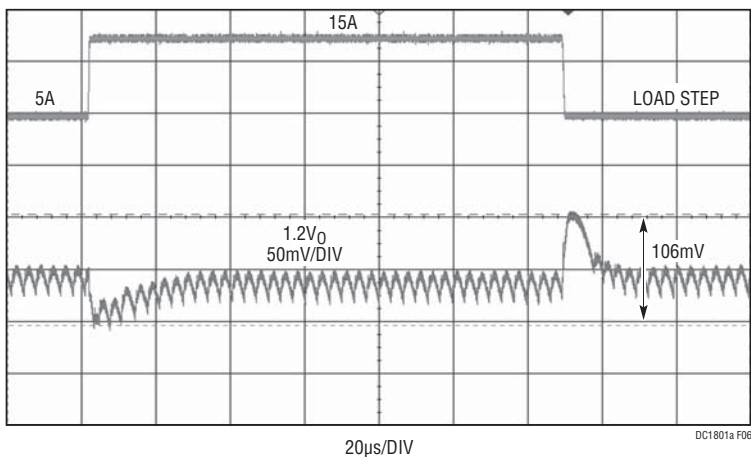

Figure 6. Load Step Response of the 1.2V Rail on the DC1801A-A (DCR_{SENSE}) at $V_{IN} = 12V$. $C_{OUT} = 2 \times$ Sanyo 2R5TPE330M9 || $2 \times 100\mu F$ X5R 6.3V 1206, $L = 0.47\mu H$, $f_{SW} = 300kHz$

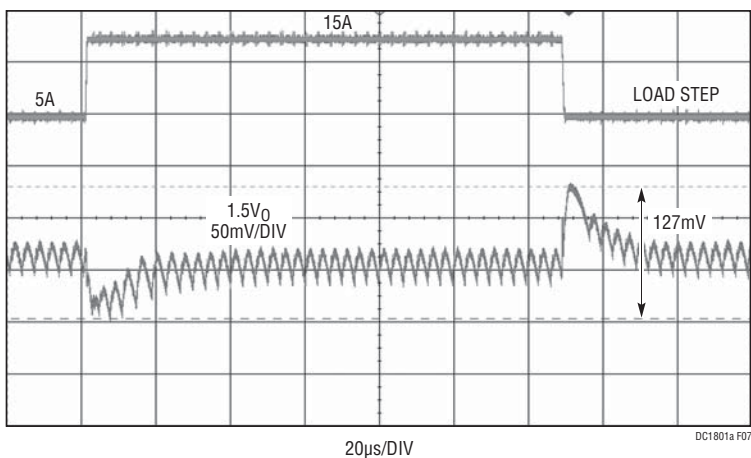

Figure 7. Load Step Response of the 1.5V Rail on the DC1801A-A (DCR_{SENSE}) at $V_{IN} = 12V$. $C_{OUT} = 2 \times$ Sanyo 2R5TPE330M9 || $2 \times 100\mu F$ X5R 6.3V 1206, $L = 0.47\mu H$, $f_{SW} = 300kHz$

QUICK START PROCEDURE

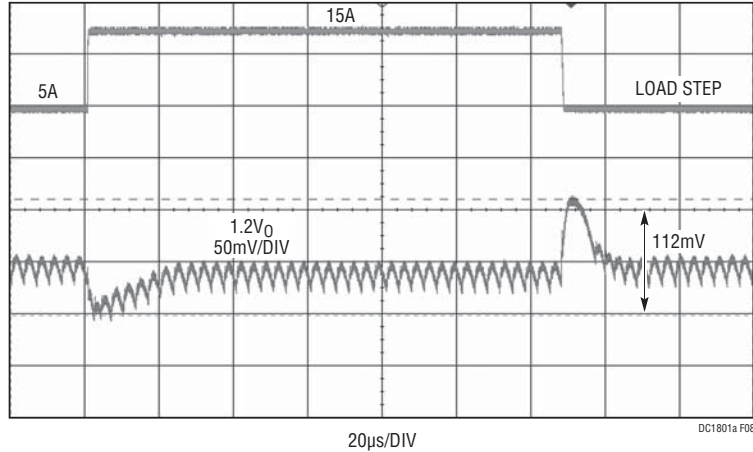

Figure 8. Load Step Response of the 1.2V Rail on the DC1801A-B (R_{SENSE}) at $V_{IN} = 12V$. $C_{OUT} = 2 \times$ Sanyo 2R5TPE330M9 || $2 \times 100\mu F$ X5R 6.3V 1206, $f_{SW} = 300kHz$, $L = 0.44\mu H$, $f_{SW} = 300kHz$

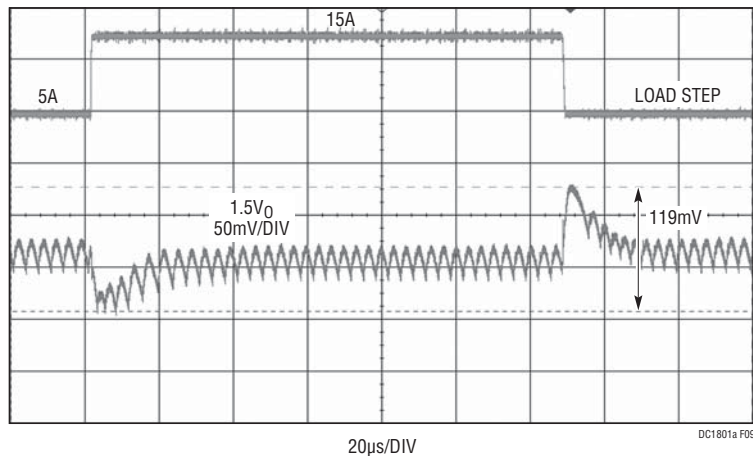

Figure 9. Load Step Response of the 1.5V Rail on the DC1801A-B (R_{SENSE}) at $V_{IN} = 12V$. $C_{OUT} = 2 \times$ Sanyo 2R5TPE330M9 || $2 \times 100\mu F$ X5R 6.3V 1206, $f_{SW} = 300kHz$, $L = 0.44\mu H$, $f_{SW} = 300kHz$

PARTS LIST

Demo Board 1801A-A

ITEM	QTY	REFERENCE	PART DESCRIPTION	MANUFACTURER/PART NUMBER
Required Circuit Components				
1	1	CIN1	CAP, 180 μ F, 16V, SVP-F8	SANYO, 16SVP180MX
2	2	CIN3, CIN5	CAP, X5R, 22 μ F, 16V, 1210	MURATA, GRM312ER61C226KE20L
3	4	COUT1, COUT2, COUT5, COUT6	CAP, 330 μ F, 2.5V, SIZE 7343	SANYO, 2R5TPE330M9
4	4	COUT3, COUT4, COUT7, COUT8	CAP, X5R, 100 μ F, 6.3V, 1206	MURATA, GRM31CR60J107ME39L
5	2	C3, C16	CAP, X6R, 0.22 μ F, 25V, 0603	MURATA, GRM188R60E224KA88D
6	5	C4, C5, C10, C13, C14	CAP, X5R, 0.1 μ F, 16V, 0603	AVX, 0603YD104KAT2A
7	2	C6, C11	CAP, NPO, 47pF, 16V, 0603	AVX, 0603YA470JAT2A
8	2	C7, C12	CAP, X7R, 470pF, 16V, 0603	AVX, 0603YC471JAT2A
9	1	C8	CAP, X5R, 4.7 μ F, 16V, 0805	AVX, 0805YD475KAT2A
10	2	C9, C18	CAP, X5R, 1 μ F, 16V, 0603	AVX, 0603YD105KAT2A
11	2	D1, D2	DIODE, SCHOTTKY, SOD-323	CENTRAL SEMI, CMDSH-4E TR
12	2	L1, L2	IND, 0.47 μ H	WÜRTH, 744355047
13	2	Q1, Q3	MOSFET, OPTIMOS, PG-TDSON-8	INFINEON, BSC050NE2LS
14	2	Q2, Q4	MOSFET, OPTIMOS, PG-TDSON-8	INFINEON, BSC010NE2LS
15	2	Q9, Q10	MOSFET, N-CH, 30V, TO-252	VISHAY, SUD50N03-12P-E3
16	7	R8, R11, R16, R35, R39, R55, R57	RES, CHIP, 0, 0603	VISHAY, CRCW06030000Z0EA
17	2	R12, R38	RES, CHIP, 100k, 1%, 0603	VISHAY, CRCW0603100KFKEA
18	3	R13, R21, R31	RES, CHIP, 15k, 1%, 0603	VISHAY, CRCW060315K0FKEA
19	0	R14, R15, R24, R29, R41, R45 (OPT)	RES, CHIP, 0603	
20	4	R17, R23, R40, R46	RES, CHIP, 10k, 1%, 0603	VISHAY, CRCW060310K0FKEA
21	2	R18, R32	RES, CHIP, 2.15k 1%, 0603	VISHAY, CRCW06032K15FKEAEA
22	4	R20, R26, R30, R36	RES, CHIP, 0, 0603	VISHAY, CRCW06030000Z0EA
23	2	R25, R27	RES, CHIP, 2.2 1%, 0603	VISHAY, CRCW06032R20FKEA
24	1	R28	RES, CHIP, 133k, 1%, 0603	VISHAY, CRCW0603133KFKEA
25	2	R42, R43	RES, CHIP, 10, 1%, 0603	VISHAY, CRCW060310R0FKED
26	2	RS1, RS2	RES, CHIP, 0.000 Ω , 2W, 2512	TEPRO, RN5326
27	1	U1	LTC3838EUHF, QFN, 38-LEAD	LINEAR TECHNOLOGY LTC3838EUHF

Additional Demo Board Circuit Components

1	0	CIN2 (OPT)	CAP, OPT, SVP-F8	
2	0	CIN4, CIN6, CIN7, CIN8 (OPT)	CAP, OPT, 1210	
3	0	C1, C2, C15, C17 (OPT)	CAP, OPT, 0603	
4	0	COUT13 TO COUT16 (OPT)	CAP, OPT, 7343	
5	0	Q5 TO Q8 (OPT)	MOSFET, OPTIMOS, PG-TDSON-8	
6	0	R1, R3, R4, R6, R7, R9, R10, R19, R34, R37, R44, R49, R50, R47, R48, R56 (OPT)	RES, CHIP, 0603	
7	2	R51, R52	RES, CHIP, 10k, 1%, 0603	VISHAY, CRCW060310K0FKEA
8	2	R53, R54	RES, CHIP, 0.01, 1/2W, 1%, 2010	VISHAY, WSL2010R0100FEA

DEMO MANUAL DC1801A

PARTS LIST

Demo Board 1801A-A

ITEM	QTY	REFERENCE	PART DESCRIPTION	MANUFACTURER/PART NUMBER
Hardware/Components (For Demo Board Only)				
1	20	E1 TO E20	TESTPOINT, TURRET, 0.095"	MILL-MAX, 2501-2-00-80-00-00-07-0
2	2	JP1, JP4	2mm SINGLE ROW HEADER, 3-PIN	SAMTEC, TMM-103-02-L-S
3	2	JP2, JP3	2mm SINGLE ROW HEADER, 4-PIN	SAMTEC, TMM-104-02-L-S
4	4	XJP1 TO XJP4	SHUNT	SAMTEC, 2SN-BK-G
5	6	J1 TO J6	JACK, BANANA	KEYSTONE, 575-4
6	2	J7, J8	CONN, BNC, 5 PINS	CONNEX, 112404
7	2	J9, J10	2mm SINGLE ROW HEADER, 2-PIN	SAMTEC, TMM-102-02-L-S
8	4	MH1 TO MH4	STAND-OFF, NYLON 0.25"	KEYSTONE, 8831 (SNAP ON)

PARTS LIST

Demo Board 1801A-B

ITEM	QTY	REFERENCE	PART DESCRIPTION	MANUFACTURER/PART NUMBER
Required Circuit Components				
1	1	CIN1	CAP, 180 μ F, 16V, SVP-F8	SANYO, 16SVP180MX
2	2	CIN3, CIN5	CAP, X5R, 22 μ F, 16V, 1210	MURATA, GRM312ER61C226KE20L
3	4	COUT1, COUT2, COUT5, COUT6	CAP, 330 μ F, 2.5V, SIZE 7343	SANYO, 2R5TPE330M9
4	4	COUT3, COUT4, COUT7, COUT8	CAP, X5R, 100 μ F, 6.3V, 1206	MURATA, GRM31CR60J107ME39L
5	2	C3, C16	CAP, X7R, 1000pF, 16V, 0603	AVX, 0603YC102KAT2A
6	5	C4, C5, C10, C13, C14	CAP, X5R, 0.1 μ F, 16V, 0603	AVX, 0603YD104KAT2A
7	2	C6, C11	CAP, NPO, 47pF, 16V, 0603	AVX, 0603YA470JAT2A
8	2	C7, C12	CAP, X7R, 470pF, 16V, 0603	AVX, 0603YC471JAT2A
9	1	C8	CAP, X5R, 4.7 μ F, 16V, 0805	AVX, 0805YD475KAT2A
10	2	C9, C18	CAP, X5R, 1 μ F, 16V, 0603	AVX, 0603YD105KAT2A
11	2	D1, D2	DIODE, SCHOTTKY, SOD-323	CENTRAL SEMI, CMDSH-4E TR
12	2	L1, L2	IND, 0.44 μ H	COOPER, FP1308R3-R44-R
13	2	Q1, Q3	MOSFET, OPTIMOS, PG-TDSON-8	INFINEON, BSC050NE2LS
14	2	Q2, Q4	MOSFET, OPTIMOS, PG-TDSON-8	INFINEON, BSC010NE2LS
15	2	Q9, Q10	MOSFET, N-CH, 30V, TO-252	VISHAY, SUD50N03-12P-E3
16	7	R8, R11, R16, R35, R39, R55, R57	RES, CHIP, 0, 0603	VISHAY, CRCW06030000Z0EA
17	2	R12, R38	RES, CHIP, 100k, 1%, 0603	VISHAY, CRCW0603100KFKEA
18	3	R13, R21, R31	RES, CHIP, 15k, 1%, 0603	VISHAY, CRCW060315K0FKEA
19	4	R14, R15, R41, R45	RES, CHIP, 10, 1%, 0603	VISHAY, CRCW060310R0FKED
20	4	R17, R23, R40, R46	RES, CHIP, 10k, 1%, 0603	VISHAY, CRCW060310K0FKEA
21	2	R24, R29	RES, CHIP, 0, 0603	VISHAY, CRCW06030000Z0EA
22	2	R25, R27	RES, CHIP, 2.2 1%, 0603	VISHAY, CRCW06032R20FKEA
23	1	R28	RES, CHIP, 133k, 1%, 0603	VISHAY, CRCW0603133KFKEA
24	2	R42, R43	RES, CHIP, 10, 1%, 0603	VISHAY, CRCW060310R0FKED
25	2	RS1, RS2	RES, CHIP, 2m Ω , 2W, 1%, 2512	VISHAY, WSL25122L000FEA
26	1	U1	LTC3838EUHF, QFN, 38-LEAD,	LINEAR TECHNOLOGY LTC3838EUHF

Additional Demo Board Circuit Components

1	0	CIN2 (OPT)	CAP, OPT, SVP-F8	
2	0	CIN4, CIN6 TO CIN8 (OPT)	CAP, OPT, 1210	
3	0	C1, C2, C15, C17 (OPT)	CAP, OPT, 0603	
4	0	COUT13 TO COUT16 (OPT)	CAP, OPT, 7343	
5	0	Q5 TO Q8 (OPT)	MOSFET, OPTIMOS, PG-TDSON-8	
6	0	R1, R3, R4, R6, R7, R9, R10, R19, R34, R37, R44, R49, R50, R47, R48, R56 (OPT)	RES, CHIP, 0603	
7	2	R51, R52	RES, CHIP, 10k, 1%, 0603	VISHAY, CRCW060310K0FKEA
8	2	R53, R54	RES, CHIP, 0.01, 1/2W, 1%, 2010	VISHAY, WSL2010R0100FEA
9	0	R18, R20, R26, R30, R32, R36 (OPT)	RES, CHIP, 0603	

DEMO MANUAL DC1801A

PARTS LIST

Demo Board 1801A-B

ITEM	QTY	REFERENCE	PART DESCRIPTION	MANUFACTURER/PART NUMBER
Hardware/Components (For Demo Board Only)				
1	20	E1 TO E20	TESTPOINT, TURRET, 0.095"	MILL-MAX, 2501-2-00-80-00-00-07-0
2	2	JP1 TO JP4	2mm SINGLE ROW HEADER, 3-PIN	SAMTEC, TMM-103-02-L-S
3	2	JP2, JP3	2mm SINGLE ROW HEADER, 4-PIN	SAMTEC, TMM-104-02-L-S
4	4	XJP1 TO XJP4	SHUNT	SAMTEC, 2SN-BK-G
5	6	J1 TO J6	JACK, BANANA	KEYSTONE, 575-4
6	2	J7, J8	CONN, BNC, 5 PINS	CONNEX, 112404
7	2	J9, J10	2mm SINGLE ROW HEADER, 2-PIN	SAMTEC, TMM-102-02-L-S
8	4	MH1 TO MH4	STAND-OFF, NYLON 0.25"	KEYSTONE, 8831 (SNAP ON)

SCHEMATIC DIAGRAM

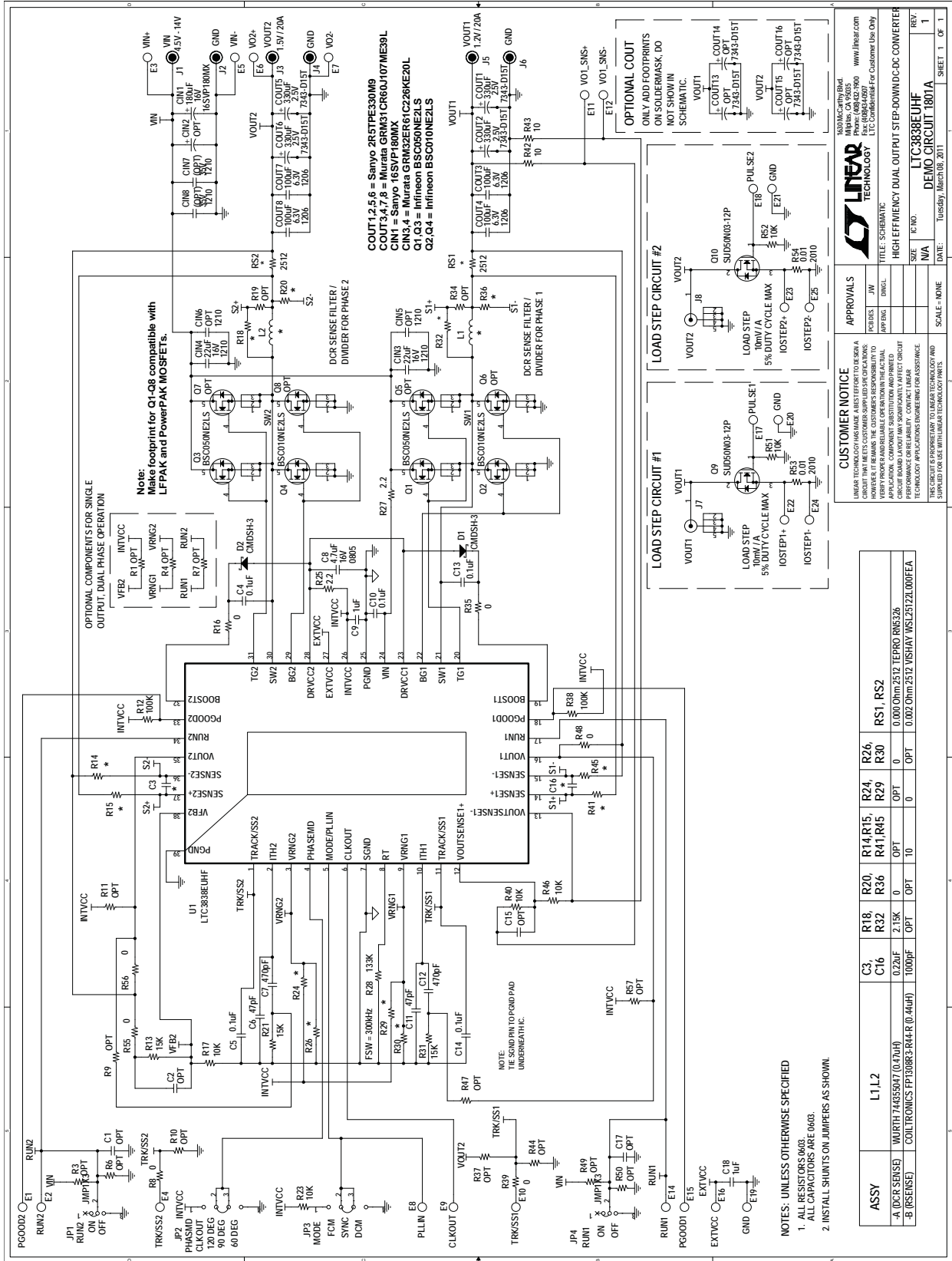

Information furnished by Linear Technology Corporation is believed to be accurate and reliable. However, no responsibility is assumed for its use. Linear Technology Corporation makes no representation that the interconnection of its circuits as described herein will not infringe on existing patent rights.

DEMO MANUAL DC1801A

DEMONSTRATION BOARD IMPORTANT NOTICE

Linear Technology Corporation (LTC) provides the enclosed product(s) under the following **AS IS** conditions:

This demonstration board (DEMO BOARD) kit being sold or provided by Linear Technology is intended for use for **ENGINEERING DEVELOPMENT OR EVALUATION PURPOSES ONLY** and is not provided by LTC for commercial use. As such, the DEMO BOARD herein may not be complete in terms of required design-, marketing-, and/or manufacturing-related protective considerations, including but not limited to product safety measures typically found in finished commercial goods. As a prototype, this product does not fall within the scope of the European Union directive on electromagnetic compatibility and therefore may or may not meet the technical requirements of the directive, or other regulations.

If this evaluation kit does not meet the specifications recited in the DEMO BOARD manual the kit may be returned within 30 days from the date of delivery for a full refund. **THE FOREGOING WARRANTY IS THE EXCLUSIVE WARRANTY MADE BY THE SELLER TO BUYER AND IS IN LIEU OF ALL OTHER WARRANTIES, EXPRESSED, IMPLIED, OR STATUTORY, INCLUDING ANY WARRANTY OF MERCHANTABILITY OR FITNESS FOR ANY PARTICULAR PURPOSE. EXCEPT TO THE EXTENT OF THIS INDEMNITY, NEITHER PARTY SHALL BE LIABLE TO THE OTHER FOR ANY INDIRECT, SPECIAL, INCIDENTAL, OR CONSEQUENTIAL DAMAGES.**

The user assumes all responsibility and liability for proper and safe handling of the goods. Further, the user releases LTC from all claims arising from the handling or use of the goods. Due to the open construction of the product, it is the user's responsibility to take any and all appropriate precautions with regard to electrostatic discharge. Also be aware that the products herein may not be regulatory compliant or agency certified (FCC, UL, CE, etc.).

No License is granted under any patent right or other intellectual property whatsoever. **LTC assumes no liability for applications assistance, customer product design, software performance, or infringement of patents or any other intellectual property rights of any kind.**

LTC currently services a variety of customers for products around the world, and therefore this transaction **is not exclusive**.

Please read the DEMO BOARD manual prior to handling the product. Persons handling this product must have electronics training and observe good laboratory practice standards. **Common sense is encouraged.**

This notice contains important safety information about temperatures and voltages. For further safety concerns, please contact a LTC application engineer.

Mailing Address:

Linear Technology
1630 McCarthy Blvd.
Milpitas, CA 95035

Copyright © 2004, Linear Technology Corporation

X-ON Electronics

Largest Supplier of Electrical and Electronic Components

Click to view similar products for [Power Management IC Development Tools](#) category:

Click to view products by [Analog Devices](#) manufacturer:

Other Similar products are found below :

[EVAL-ADM1168LQEBZ](#) [EVB-EP5348UI](#) [MIC23451-AAAYFL EV](#) [MIC5281YMME EV](#) [DA9063-EVAL](#) [ADP122-3.3-EVALZ](#) [ADP130-0.8-EVALZ](#) [ADP130-1.2-EVALZ](#) [ADP130-1.5-EVALZ](#) [ADP130-1.8-EVALZ](#) [ADP1714-3.3-EVALZ](#) [ADP1716-2.5-EVALZ](#) [ADP1740-1.5-EVALZ](#) [ADP1752-1.5-EVALZ](#) [ADP1828LC-EVALZ](#) [ADP1870-0.3-EVALZ](#) [ADP1871-0.6-EVALZ](#) [ADP1873-0.6-EVALZ](#) [ADP1874-0.3-EVALZ](#) [ADP1882-1.0-EVALZ](#) [ADP199CB-EVALZ](#) [ADP2102-1.25-EVALZ](#) [ADP2102-1.875EVALZ](#) [ADP2102-1.8-EVALZ](#) [ADP2102-2-EVALZ](#) [ADP2102-3-EVALZ](#) [ADP2102-4-EVALZ](#) [ADP2106-1.8-EVALZ](#) [ADP2147CB-110EVALZ](#) [AS3606-DB](#) [BQ24010EVM](#) [BQ24075TEVM](#) [BQ24155EVM](#) [BQ24157EVM-697](#) [BQ24160EVM-742](#) [BQ24296MEVM-655](#) [BQ25010EVM](#) [BQ3055EVM](#) [NCV891330PD50GEVB](#) [ISLUSBI2CKIT1Z](#) [LM2744EVAL](#) [LM2854EVAL](#) [LM3658SD-AEV/NOPB](#) [LM3658SDEV/NOPB](#) [LM3691TL-1.8EV/NOPB](#) [LM4510SDEV/NOPB](#) [LM5033SD-EVAL](#) [LP38512TS-1.8EV](#) [EVAL-ADM1186-1MBZ](#) [EVAL-ADM1186-2MBZ](#)