

LTM4676A Dual Step-Down μ Module Regulator with PMBus Digital Power System Management

DESCRIPTION

Demonstration circuit 1811B-B is a dual-output, high efficiency, high density, μ Module[®] regulator with 4.5V to 26.5V input range. Each output can supply 13A maximum load current. The demo board has a [LTM[®]4676A](#) μ Module regulator, which is a dual 13A or single 26A step-down regulator with PMBus power system management. Please see LTM4676A data sheet for more detailed information.

The DC1811B-B powers up to default settings and produces power based on configuration resistors without the need for any serial bus communication. This allows easy evaluation of the DC/DC converter. To fully explore the extensive power system management features of the part, download the GUI software LTpowerPlay[®] onto your

PC and use ADI's I²C/SMBus/PMBus dongle DC1613A to connect to the board. LTpowerPlay allows the user to reconfigure the part on-the-fly and store the configuration in EEPROM, view telemetry of voltage, current, temperature and fault status.

GUI Download

The software can be downloaded from: [LTpowerPlay](#)

For more details and instructions of LTpowerPlay, please refer to LTpowerPlay GUI for LTM4676A Quick Start Guide.

[Design files for this circuit board are available.](#)

All registered trademarks and trademarks are the property of their respective owners.

BOARD PHOTO

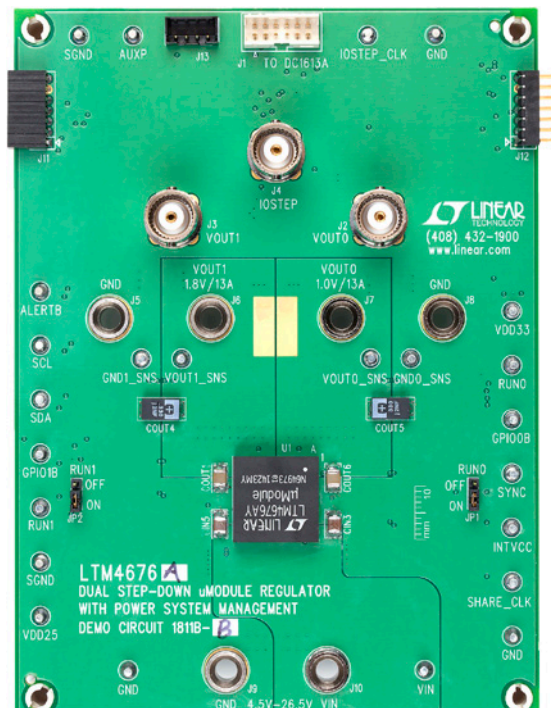

Figure 1. Dual-Output LTM4676A/DC1811B-B Demo Circuit

DEMO MANUAL DC1811B-B

PERFORMANCE SUMMARY (T_A = 25°C)

PARAMETER	CONDITION	VALUE
Input Voltage Range		4.5V to 26.5V
Output Voltage, V _{OUT0}	V _{IN} = 4.5V to 26.5V, I _{OUT0} = 0A to 13A	0.5V to 5.5V (Minimum On)*, Default: 1V
Maximum Output Current, I _{OUT0}	V _{IN} = 4.5V to 26.5V, V _{OUT} = 0.5V to 5.5V	13A
Output Voltage, V _{OUT1}	V _{IN} = 4.5V to 26.5V, I _{OUT1} = 0A to 13A	0.5V to 5.5V (Minimum On)*, Default: 1.8V
Maximum Output Current, I _{OUT1}	V _{IN} = 4.5V to 26.5V, V _{OUT} = 0.5V to 5.5V	13A
Typical Efficiency	V _{IN} = 12V, V _{OUT} = 1.8V, I _{OUT} = 13A	86.3%
Default Switching Frequency		500kHz

*For low duty cycle applications, it may approach minimum on the limit. The minimum on-time for LTM4676A is 45ns nominal, guardband to 90ns.

QUICK START PROCEDURE

Table 1. LTM4676/LTM4676A Demo Cards for Up to 130A Point-of-Load Regulation

MAXIMUM OUTPUT CURRENT	NUMBER OF OUTPUT VOLTAGES	NUMBER OF LTM4676/LTM4676A μ MODULE REGULATORS ON THE BOARD	DEMO BOARD NUMBER
13A, 13A	2	1× LTM4676	DC1811A/DC1811B-A
13A, 13A	2	1× LTM4676A	DC1811B-B
26A	1	1× LTM4676	DC2087A
50A	1	2× LTM4676	DC1989A-A
75A	1	3× LTM4676	DC1989A-B
100A	1	4× LTM4676	DC1989A-C
100A	1	1× LTM4676 (+ 3× LTM4620A)	DC2106A-A
130A	1	1× LTM4676 (+ 3× LTM4630)	DC2106A-B

Demonstration circuit 1811B-B is easy to set up to evaluate the performance of the LTM4676A. Refer to Figure 2 for the proper measurement equipment setup and follow the procedure below.

1. With power off, connect the input power supply to V_{IN} (4.5V to 26.5V) and GND (input return).
2. Connect the 1.0V output load between V_{OUT0} and GND (Initial load: no load).
3. Connect the 1.8V output load between V_{OUT1} and GND (Initial load: no load).
4. Connect the DVMs to the input and outputs. Set default jumper position: JP1: ON; JP2: ON.
5. Turn on the input power supply and check for the proper output voltages. V_{OUT0} should be 1.0V \pm 0.5%, and V_{OUT1} should be 1.8V \pm 0.5%.
6. Once the proper output voltages are established, adjust the loads within the operating range and observe the output voltage regulation, ripple voltage and other parameters.

7. Connect the dongle and control the output voltages from the GUI. See “LTpowerPlay GUI for the LTM4676A Quick Start Guide” for details.

Note: When measuring the output or input voltage ripple, do not use the long ground lead on the oscilloscope probe. See Figure 3 for the proper scope probe technique. Short, stiff leads need to be soldered to the (+) and (–) terminals of an output capacitor. The probe’s ground ring needs to touch the (–) lead and the probe tip needs to touch the (+) lead.

Connecting a PC to DC1811B-B

You can use a PC to reconfigure the power management features of the LTM4676A such as: nominal V_{OUT}, margin set points, OV/UV limits, temperature fault limits, sequencing parameters, the fault log, fault responses, GPIOs and other functionality. The DC1613A dongle may be plugged when V_{IN} is present.

QUICK START PROCEDURE

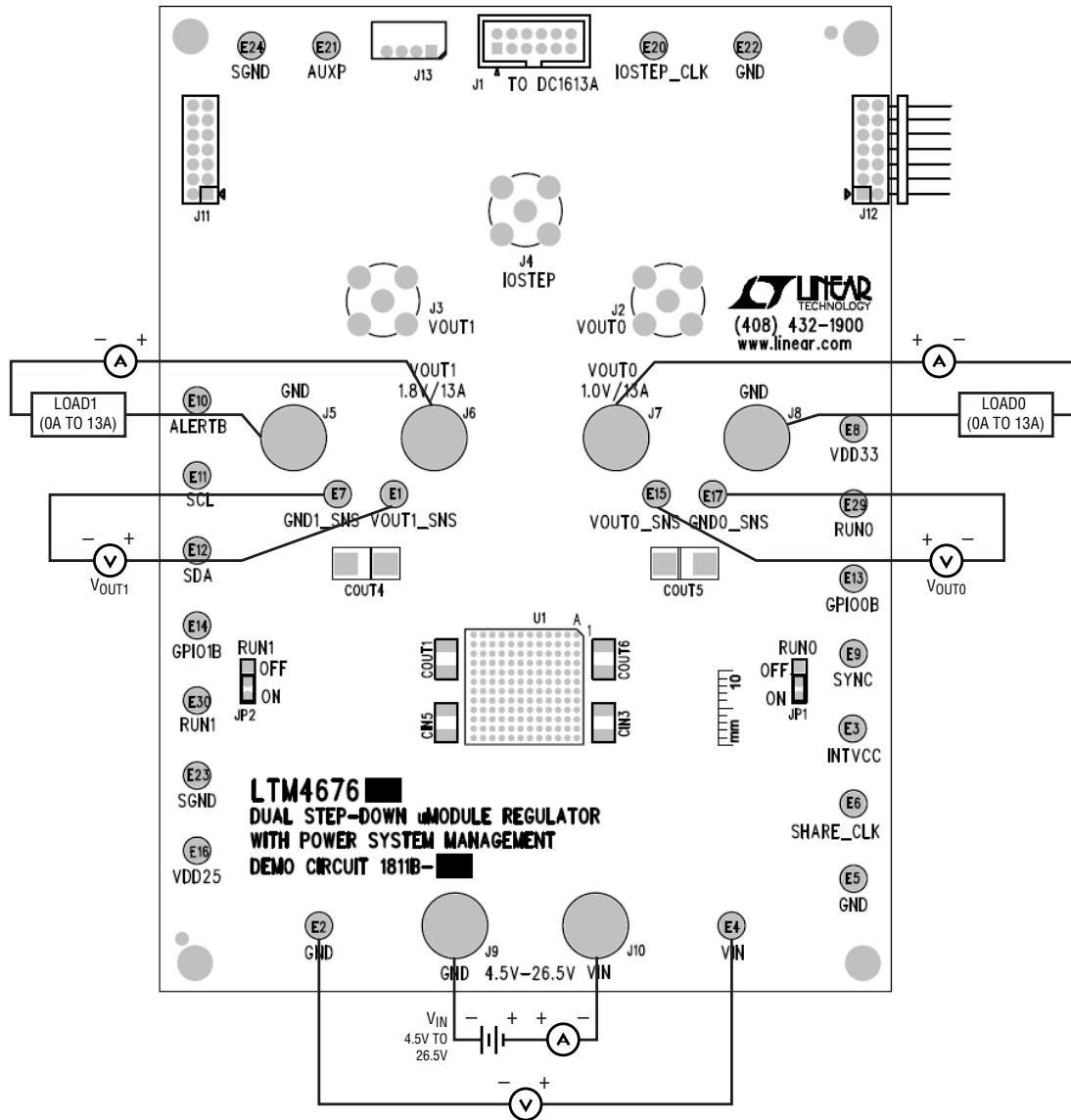

Figure 2. Proper Measurement Equipment Setup

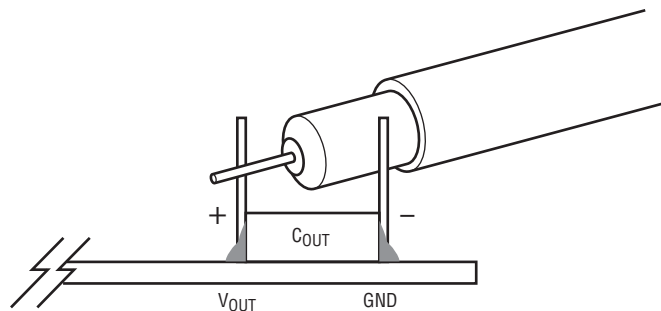

Figure 3. Measuring Output Voltage Ripple

QUICK START PROCEDURE

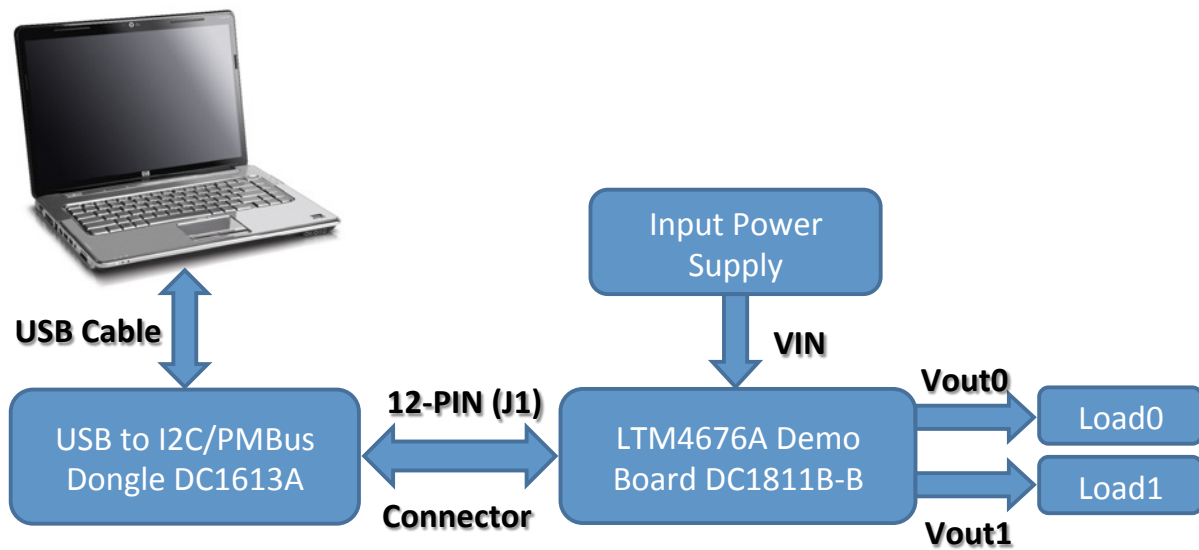

Figure 4. Demo Setup with PC

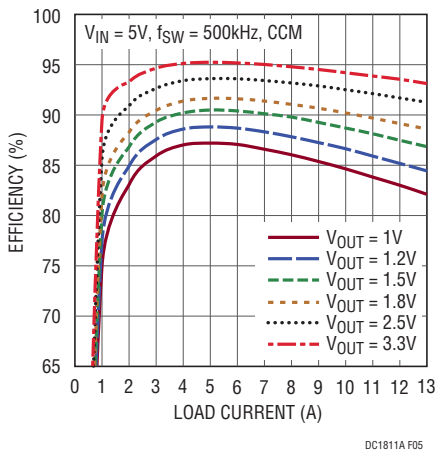

Figure 5. Efficiency vs Load Current at $V_{IN} = 5V$

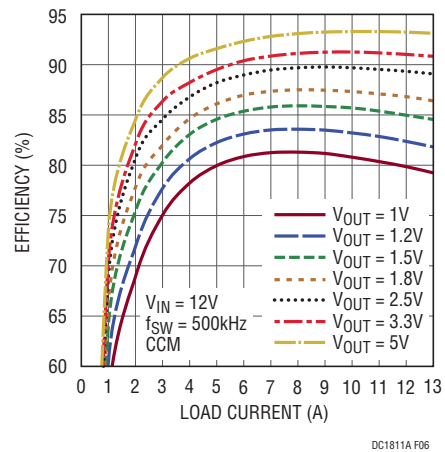

Figure 6. Efficiency vs Load Current at $V_{IN} = 12V$

QUICK START PROCEDURE

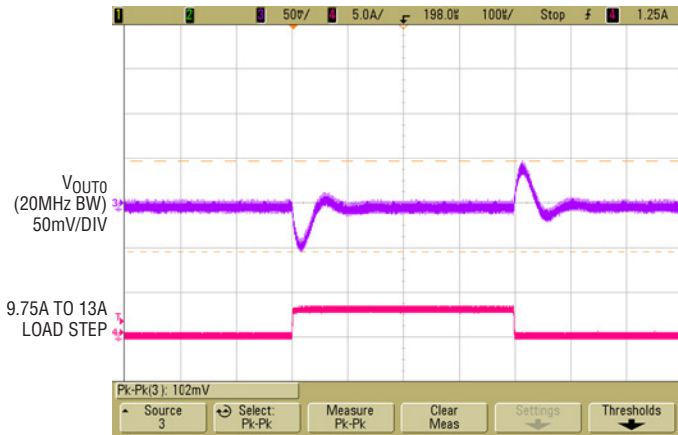

Figure 7. Output Voltage V_{OUT0} vs Load Current (V_{OUT0} Range = 0)

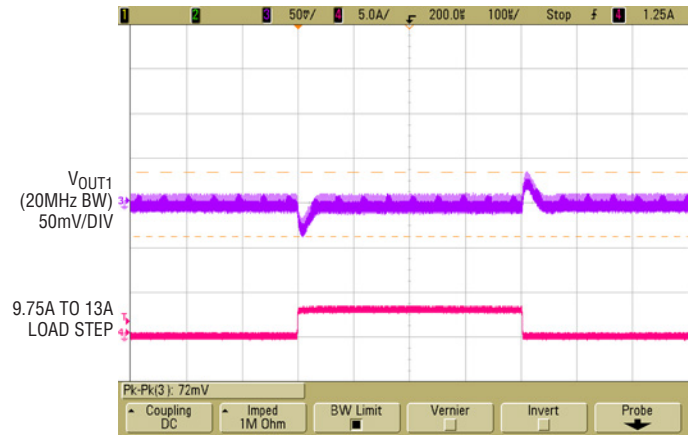

Figure 8. Output Voltage V_{OUT1} vs Load Current (V_{OUT1} Range = 1)

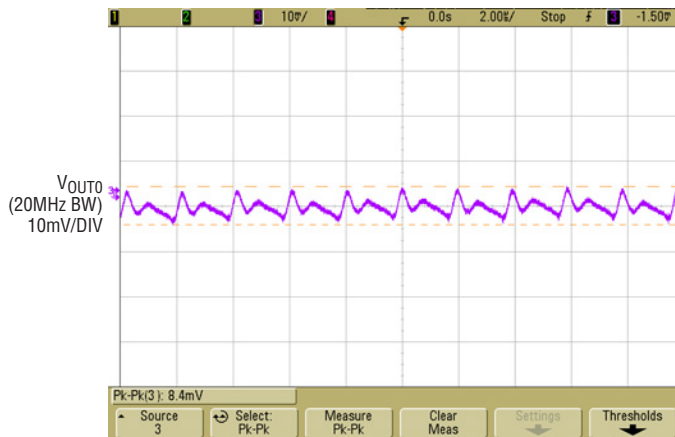

Figure 9. Output Voltage Ripple at $V_{IN} = 12V$, $V_{OUT0} = 1V$, $I_{OUT0} = 13A$

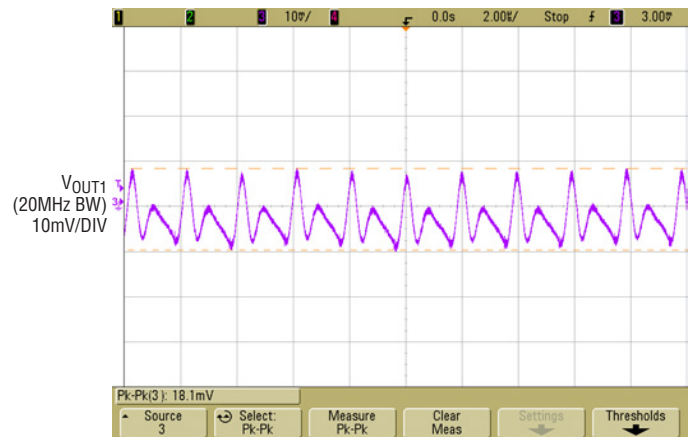

Figure 10. Output Voltage Ripple at $V_{IN} = 12V$, $V_{OUT1} = 1.8V$, $I_{OUT1} = 13A$

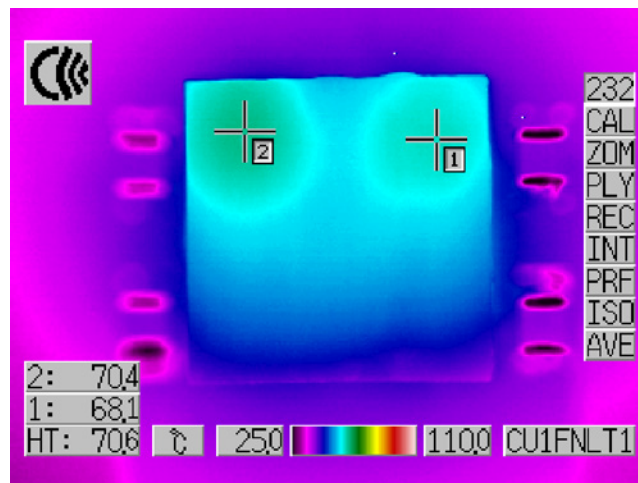

Figure 11. Thermal Performance at $V_{IN} = 12V$, $V_{OUT0} = 1.0V$, $I_{OUT0} = 13A$, $V_{OUT1} = 1.8V$, $I_{OUT1} = 13A$, $T_A = 24^\circ C$, 200LFM Airflow

DEMO MANUAL DC1811B-B

LTpowerPlay SOFTWARE GUI

LTpowerPlay is a powerful Windows-based development environment that supports Analog Devices power system management ICs, including the LTM4676A, LTC3880, LTC3883, LTC2974 and LTC2978. The software supports a variety of different tasks. You can use LTpowerPlay to evaluate Analog Devices ICs by connecting to a demo board system. LTpowerPlay can also be used in an offline mode (with no hardware present) in order to build a multichip configuration file that can be saved and reloaded at a later time. LTpowerPlay provides unprecedented diagnostic and debug features. It becomes a valuable diagnostic tool during board bring-up to program or tweak the power management scheme in a system, or to diagnose power

issues when bringing up rails. LTpowerPlay utilizes the DC1613A USB-to-SMBus controller to communicate with one of many potential targets, including the LTM4676A, the LTC3880 and the LTC3883's demo system, or a customer board. The software also provides an automatic update feature to keep the software current with the latest set of device drivers and documentation. The LTpowerPlay software can be downloaded from:

[LTpowerPlay](#)

To access technical support documents for ADI Digital Power Products visit [Help](#). View online help on the [LTpowerPlay](#) menu.

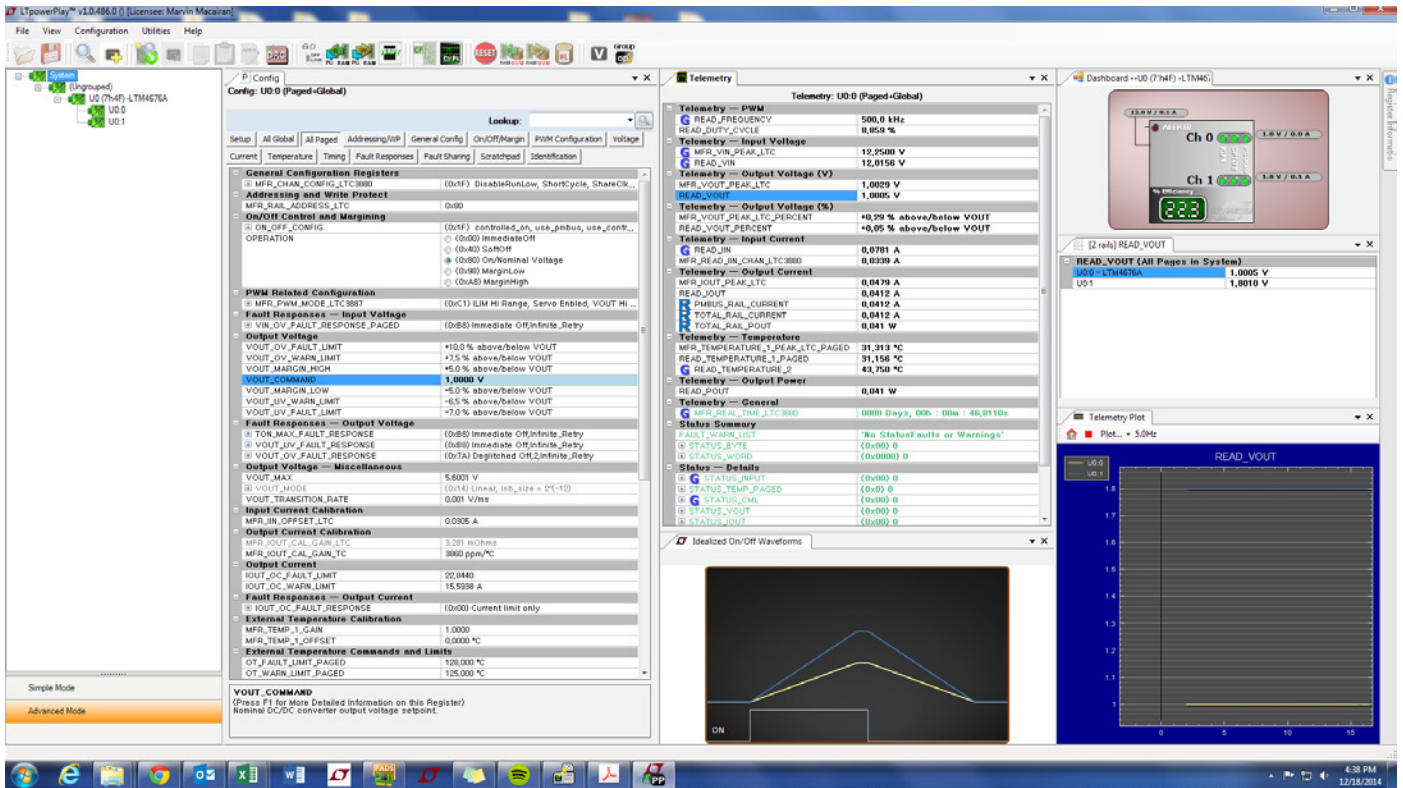

Figure 12. LTpowerPlay Main Interface

LTpowerPlay QUICK START GUIDE

The following procedure describes how to use LTpowerPlay to monitor and change the settings of LTM4676A.

1. Download and install the LTPowerPlay GUI:

[LTpowerPlay](#)

2. Launch the LTpowerPlay GUI.

- a. The GUI should automatically identify the DC1811B-B. The system tree on the left hand side should look like this:

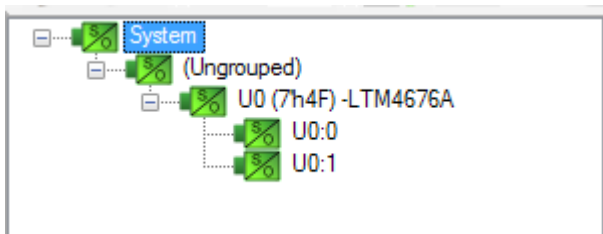

- b. A green message box shows for a few seconds in the lower left hand corner, confirming that LTM4676A is communicating:

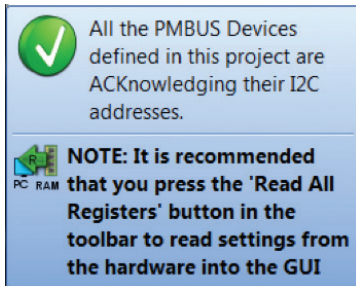

- c. In the Toolbar, click the “R” (RAM to PC) icon to read the RAM from the LTM4676A. This reads the configuration from the RAM of LTM4676A and loads it into the GUI.



- d. If you want to change the output voltage to a different value, like 1.5V. In the Config tab, type in 1.5 in the VOUT_COMMAND box, like this:

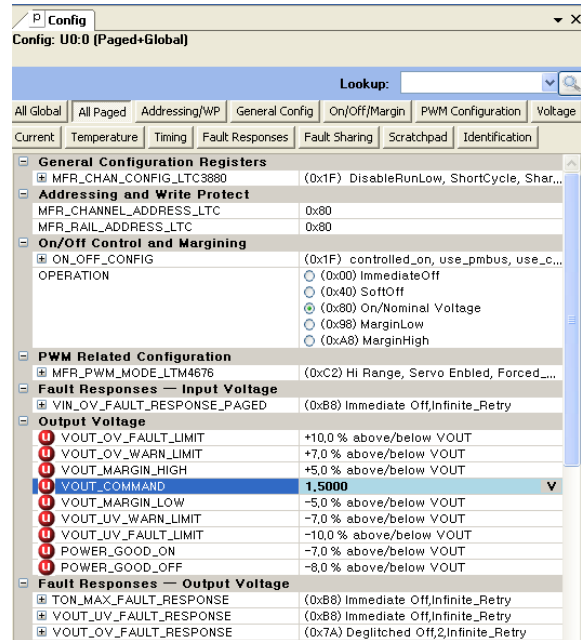

Then, click the “W” (PC to RAM) icon to write these register values to the LTM4676A. After finishing this step, you will see the output voltage will change to 1.5V.



If the write is successful, you will see the following message:

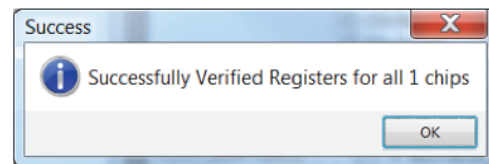

- e. You can save the changes into the NVM. In the toolbar, click “RAM to NVM” button, as following



- f. Save the demo board configuration to a (*.proj) file. Click the Save icon and save the file. Name it whatever you want.

DEMO MANUAL DC1811B-B

PARTS LIST

ITEM	QTY	REFERENCE	PART DESCRIPTION	MANUFACTURER/PART NUMBER
Required Circuit Components				
1	1	CIN1	CAP., 150µF, 35V, ALUMINUM ELECTR.,	SUN ELECT., 35CE150AX
2	4	CIN2, CIN3, CIN4, CIN5	CAP., X5R, 10µF, 35V, 10%,1210	MURATA, GRM32ER6YA106KA12
3	6	COU1-COU3, COU6-COU8	CAP., X5R, 100µF, 6.3V, 20%, 1210	AVX, 12106D107MAT2A
4	2	COU4, COU5	CAP., 330µF, 6.3V, POSCAP, D3L	PANASONIC, 6TPF330M9L
5	2	C1, C14	CAP., X7R, 2200pF, 25V, 10%, 0603	AVX, 06033C222KAT2A
6	1	C26	CAP., X5R, 100nF, 16V, 10%,0603	AVX, 0603YD104KAT2A
7	2	C27, C28	CAP., X7R, 10nF, 16V, 10%,0603	AVX, 0603YC103KAT2A
8	1	C23	CAP., X7R, 1µF, 25V,10%, 0805	AVX, 08053C105KAT2A
9	3	C21, C22, C24	CAP., X5R, 1µF, 25V,10%, 0603	AVX, 06033D105KAT2A
10	2	JP1, JP2	HEADER 3-PIN 0.079 SINGLE ROW	SULLIN, NRPNO31PAEN-RC
11	3	J2-J4	CONN, BNC, 5 PINS	CONNEX, 112404
12	1	J1	CONN HEADER 12POS 2mm STR DL PCB	FCI, 98414-G06-12ULF
13	6	J5-J10	BANANA JACK	KEYSTONE, 575-4
14	1	Q1	N-CHANNEL 40-V MOSFET	VISHAY, SUD50N04-8M8P-4GE3
15	1	D8	DIODE, ULTRA LOW SCHOTTKY RECTIFIER	NXP SEMI., PMEG2005AEL
16	1	Q19	P-CHANNEL 30-V MOSFET	DIODES INC., DMP3130L-7
17	1	J11	CONN RECEIPT 2mm DUAL R/A 14POS (F)	SULLINS, NPPN072FJFN-RC
18	1	J12	HEADER 14POS 2mm R/A GOLD (M)	MOLEX, 87760-1416
19	1	J13	HEADER, 4 PINS, SHROUDED	HIROSE, DF3A-4P-2DSA
20	10	R3, R5, R7, R9, R25, R31, R32, R63, R65, R66	RES., CHIP, 0Ω, 1%, 0603	NIC, NRC06ZOTRF
21	2	R69, R70	RES., CHIP, 10k, 1%, 0603	NIC, NRC06F10R0TRF
22	12	R10-R16, R18, R19, R24, R52, R77	RES., CHIP, 10k, 1%, 0603	NIC, NRC06F1002TRF
23	1	R78	RES., CHIP, 15.8k, 1%, 0603	NIC, NRC06F1582TRF
24	1	R30	RES., CHIP, 6.34k, 1%, 0603	VISHAY, CRCW06036K34FKEA
25	3	R2, R72, R73	RES., CHIP, 4.99k, 1%, 0603	NIC, NRC06F4991TRF
26	1	R22	RES., CHIP, 4.22k, 1%, 0603	VISHAY, CRCW06034K22FKEA
27	1	R48	RES., CHIP, 0Ω, 0.5W, 2010	NIC, NRC50ZOTRF
28	1	R53	RES., CHIP, 0.01Ω, 1/2W, 1%, 2010	VISHAY, WSL2010R0100FEA
29	1	U3	IC, 24LC025-I/ST, SOIC	MICROCHIP, 24LC025-I/ST
30	1	U1	IC, LTM4676AEY#PBF	ANALOG DEVICES, LTM4676AEY#PBF
Additional Demo Board Circuit Components				
1	0	C2, C15-C17(OPT)	CAP., 0603	
2	0	D1, D2 (OPT)	DIODE, SOD-323	
3	0	R4, R6, R8, R20, R23, R26-R29, R33, R35, R37, R38, R41, R49, R61, R62, R64, R67, R68, R74, R75, R82, R83, R88, R89 (OPT)	RES., OPTIONAL	
4	0	R50, R51(OPT)	RES., CHIP, 30, 1%, 2512	
Hardware-For Demo Board Only				
1	24	E1-E17, E20-E24, E28, E29	TESTPOINT, TURRET, 0.062"	MILL-MAX, 2308-2-00-80-00-00-07-0
2	2	XJP1, XJP2	SHUNT	SAMTEC, 2SN-BK-G
3	4	(STAND-OFF)	STAND-OFF, NYLON 0.50" TALL (SNAP ON)	KEYSTONE, 8833
4	1		FAB, PRINTED CIRCUIT BOARD	DEMO CIRCUIT 1811B-B

SCHEMATIC DIAGRAM

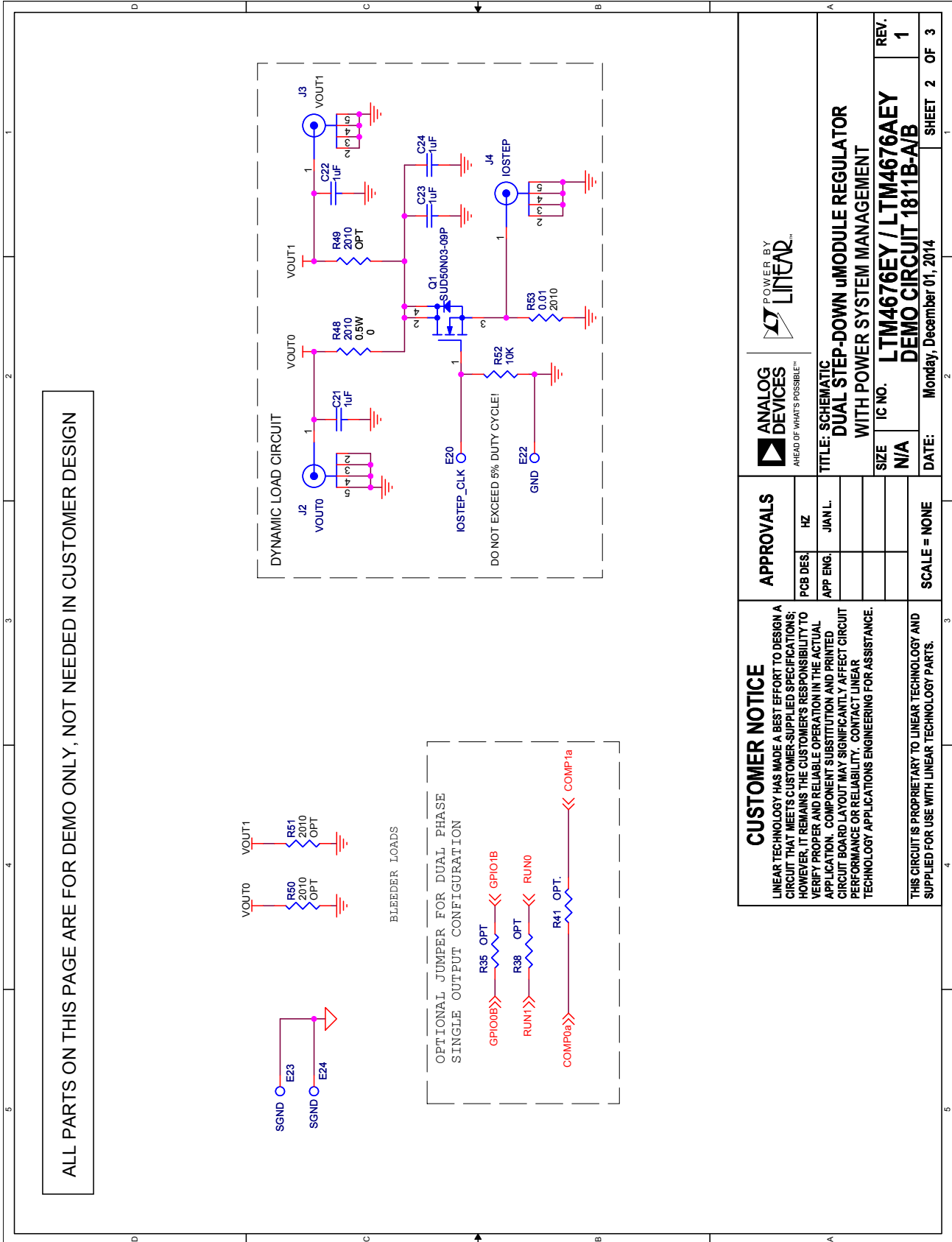

SCHEMATIC DIAGRAM

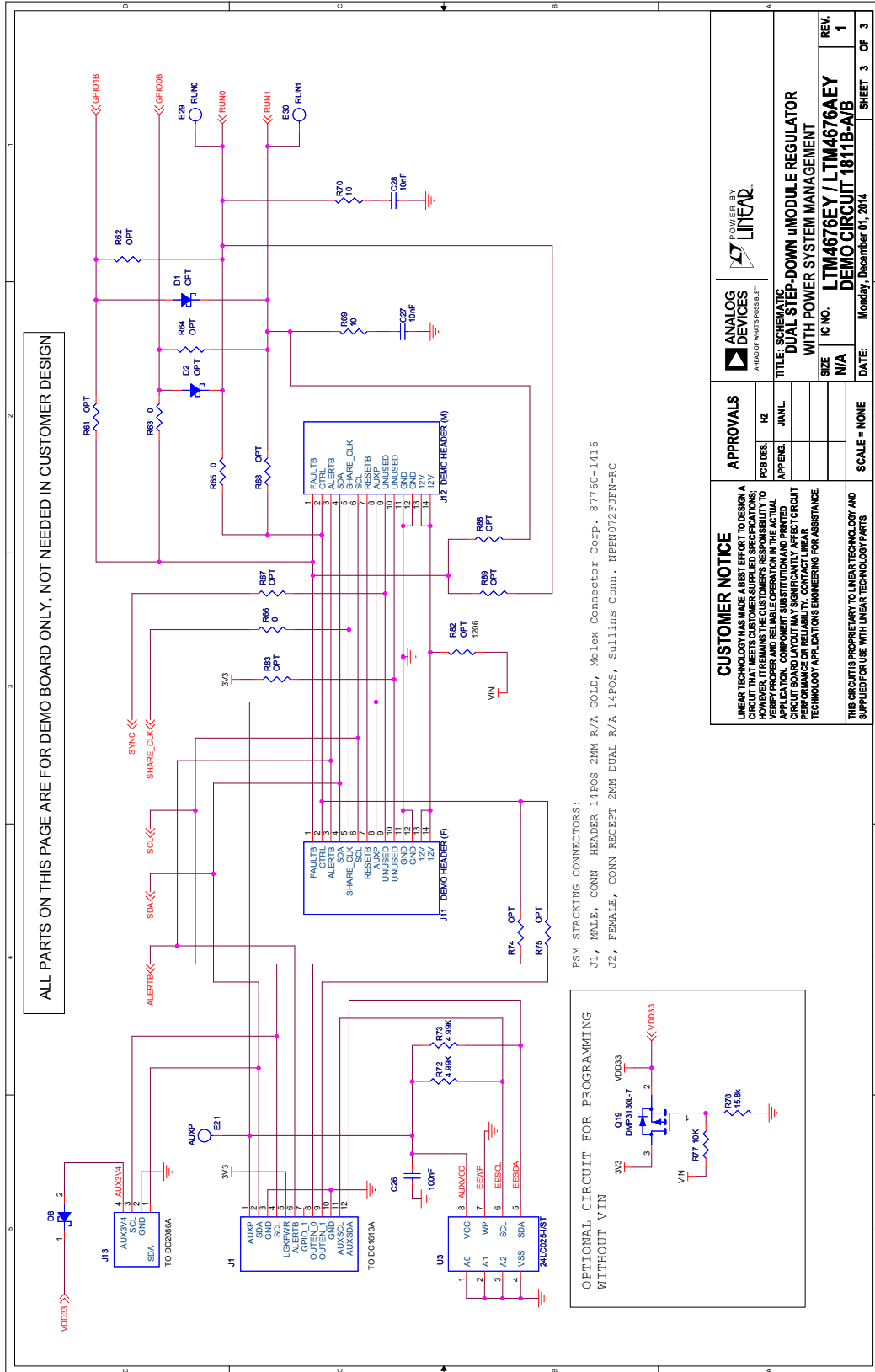



ESD Caution

ESD (electrostatic discharge) sensitive device. Charged devices and circuit boards can discharge without detection. Although this product features patented or proprietary protection circuitry, damage may occur on devices subjected to high energy ESD. Therefore, proper ESD precautions should be taken to avoid performance degradation or loss of functionality.

Legal Terms and Conditions

By using the evaluation board discussed herein (together with any tools, components documentation or support materials, the "Evaluation Board"), you are agreeing to be bound by the terms and conditions set forth below ("Agreement") unless you have purchased the Evaluation Board, in which case the Analog Devices Standard Terms and Conditions of Sale shall govern. Do not use the Evaluation Board until you have read and agreed to the Agreement. Your use of the Evaluation Board shall signify your acceptance of the Agreement. This Agreement is made by and between you ("Customer") and Analog Devices, Inc. ("ADI"), with its principal place of business at One Technology Way, Norwood, MA 02062, USA. Subject to the terms and conditions of the Agreement, ADI hereby grants to Customer a free, limited, personal, temporary, non-exclusive, non-sublicensable, non-transferable license to use the Evaluation Board FOR EVALUATION PURPOSES ONLY. Customer understands and agrees that the Evaluation Board is provided for the sole and exclusive purpose referenced above, and agrees not to use the Evaluation Board for any other purpose. Furthermore, the license granted is expressly made subject to the following additional limitations: Customer shall not (i) rent, lease, display, sell, transfer, assign, sublicense, or distribute the Evaluation Board; and (ii) permit any Third Party to access the Evaluation Board. As used herein, the term "Third Party" includes any entity other than ADI, Customer, their employees, affiliates and in-house consultants. The Evaluation Board is NOT sold to Customer; all rights not expressly granted herein, including ownership of the Evaluation Board, are reserved by ADI. CONFIDENTIALITY. This Agreement and the Evaluation Board shall all be considered the confidential and proprietary information of ADI. Customer may not disclose or transfer any portion of the Evaluation Board to any other party for any reason. Upon discontinuation of use of the Evaluation Board or termination of this Agreement, Customer agrees to promptly return the Evaluation Board to ADI. ADDITIONAL RESTRICTIONS. Customer may not disassemble, decompile or reverse engineer chips on the Evaluation Board. Customer shall inform ADI of any occurred damages or any modifications or alterations it makes to the Evaluation Board, including but not limited to soldering or any other activity that affects the material content of the Evaluation Board. Modifications to the Evaluation Board must comply with applicable law, including but not limited to the RoHS Directive. TERMINATION. ADI may terminate this Agreement at any time upon giving written notice to Customer. Customer agrees to return to ADI the Evaluation Board at that time. LIMITATION OF LIABILITY. THE EVALUATION BOARD PROVIDED HEREUNDER IS PROVIDED "AS IS" AND ADI MAKES NO WARRANTIES OR REPRESENTATIONS OF ANY KIND WITH RESPECT TO IT. ADI SPECIFICALLY DISCLAIMS ANY REPRESENTATIONS, ENDORSEMENTS, GUARANTEES, OR WARRANTIES, EXPRESS OR IMPLIED, RELATED TO THE EVALUATION BOARD INCLUDING, BUT NOT LIMITED TO, THE IMPLIED WARRANTY OF MERCHANTABILITY, TITLE, FITNESS FOR A PARTICULAR PURPOSE OR NON-INFRINGEMENT OF INTELLECTUAL PROPERTY RIGHTS. IN NO EVENT WILL ADI AND ITS LICENSORS BE LIABLE FOR ANY INCIDENTAL, SPECIAL, INDIRECT, OR CONSEQUENTIAL DAMAGES RESULTING FROM CUSTOMER'S POSSESSION OR USE OF THE EVALUATION BOARD, INCLUDING BUT NOT LIMITED TO LOST PROFITS, DELAY COSTS, LABOR COSTS OR LOSS OF GOODWILL. ADI'S TOTAL LIABILITY FROM ANY AND ALL CAUSES SHALL BE LIMITED TO THE AMOUNT OF ONE HUNDRED US DOLLARS (\$100.00). EXPORT. Customer agrees that it will not directly or indirectly export the Evaluation Board to another country, and that it will comply with all applicable United States federal laws and regulations relating to exports. GOVERNING LAW. This Agreement shall be governed by and construed in accordance with the substantive laws of the Commonwealth of Massachusetts (excluding conflict of law rules). Any legal action regarding this Agreement will be heard in the state or federal courts having jurisdiction in Suffolk County, Massachusetts, and Customer hereby submits to the personal jurisdiction and venue of such courts. The United Nations Convention on Contracts for the International Sale of Goods shall not apply to this Agreement and is expressly disclaimed.

X-ON Electronics

Largest Supplier of Electrical and Electronic Components

Click to view similar products for [Power Management IC Development Tools](#) category:

Click to view products by [Analog Devices](#) manufacturer:

Other Similar products are found below :

[EVAL-ADM1168LQEBZ](#) [EVB-EP5348UI](#) [MIC23451-AAAYFL EV](#) [MIC5281YMME EV](#) [DA9063-EVAL](#) [ADP122-3.3-EVALZ](#) [ADP130-0.8-EVALZ](#) [ADP130-1.2-EVALZ](#) [ADP130-1.5-EVALZ](#) [ADP130-1.8-EVALZ](#) [ADP1714-3.3-EVALZ](#) [ADP1716-2.5-EVALZ](#) [ADP1740-1.5-EVALZ](#) [ADP1752-1.5-EVALZ](#) [ADP1828LC-EVALZ](#) [ADP1870-0.3-EVALZ](#) [ADP1871-0.6-EVALZ](#) [ADP1873-0.6-EVALZ](#) [ADP1874-0.3-EVALZ](#) [ADP1882-1.0-EVALZ](#) [ADP199CB-EVALZ](#) [ADP2102-1.25-EVALZ](#) [ADP2102-1.875EVALZ](#) [ADP2102-1.8-EVALZ](#) [ADP2102-2-EVALZ](#) [ADP2102-3-EVALZ](#) [ADP2102-4-EVALZ](#) [ADP2106-1.8-EVALZ](#) [ADP2147CB-110EVALZ](#) [AS3606-DB](#) [BQ24010EVM](#) [BQ24075TEVM](#) [BQ24155EVM](#) [BQ24157EVM-697](#) [BQ24160EVM-742](#) [BQ24296MEVM-655](#) [BQ25010EVM](#) [BQ3055EVM](#) [NCV891330PD50GEVB](#) [ISLUSBI2CKIT1Z](#) [LM2744EVAL](#) [LM2854EVAL](#) [LM3658SD-AEV/NOPB](#) [LM3658SDEV/NOPB](#) [LM3691TL-1.8EV/NOPB](#) [LM4510SDEV/NOPB](#) [LM5033SD-EVAL](#) [LP38512TS-1.8EV](#) [EVAL-ADM1186-1MBZ](#) [EVAL-ADM1186-2MBZ](#)