

LTC3633A

Dual Channel 3A 20V Monolithic Synchronous Step-Down Regulator Board

DESCRIPTION

Demonstration circuit DC1895 is a dual output regulator consisting of two constant-frequency step-down converters, based on the [LTC3633A](#) monolithic dual channel synchronous buck regulator. The DC1895 has an input voltage range of 3.6V to 20V, with each regulator capable of delivering up to 3A of output current. The DC1895 can operate in either Burst Mode[®] operation or forced continuous mode. In shutdown, the DC1895 can run off of less than 15 μ A total. The DC1895 is a very efficient circuit: over 90% for either circuit. The DC1895 uses the 28-Pin QFN LTC3633AEUFD package, which has an exposed pad on

the bottom-side of the IC for better thermal performance. These features, plus a programmable operating frequency range from 500kHz to 4MHz (2MHz switching frequency with the RT pin connected to INTV_{CC}), make the DC1895 demo board an ideal circuit for use industrial or distributed power applications.

Design files for this circuit board are available at <http://www.linear.com/demo/DC1895A>

LT, LTC, LTM, Burst Mode, Linear Technology and the Linear logo are registered trademarks of Analog Devices, Inc. All other trademarks are the property of their respective owners.

PERFORMANCE SUMMARY Specifications are at T_A = 25°C

PARAMETER	CONDITIONS	VALUE
Minimum Input Voltage		3.6V
Maximum Input Voltage		20V
Run	RUN Pin = GND	Shutdown
	RUN Pin = V _{IN}	Operating
Output Voltage V _{OUT1}	V _{IN} = 3.6V to 20V, I _{OUT1} = 0A to 3A	1.2V \pm 4% (1.152V to 1.248V) 1.5V \pm 4% (1.44V to 1.56V) 1.8V \pm 4% (1.728V to 1.872V)
Typical Output Ripple V _{OUT1}	V _{IN} = 12V, I _{OUT1} = 3A (20MHz BW)	< 30mV _{p-p}
Output Regulation V _{OUT1}	Line	\pm 1%
	Load	\pm 1%
Output Voltage V _{OUT2}	V _{IN} = 3.6V to 20V, I _{OUT2} = 0A to 3A	2.5V \pm 4% (2.4V to 2.6V) 3.3V \pm 4% (3.168V to 3.432V) 5V \pm 4% (4.8V to 5.2V)
Typical Output Ripple V _{OUT2}	V _{IN} = 12V, I _{OUT2} = 3A (20MHz BW)	< 30mV _{p-p}
Output Regulation V _{OUT2}	Line	\pm 1%
	Load	\pm 1%
Nominal Switching Frequencies	RT Pin connected to 324k	1MHz
	RT Pin = INTV _{CC}	2MHz
Burst Mode Operation	Channel 1: V _{IN} = 12V, V _{OUT1} = 1.8V, f _{SW} = 1 MHz	I _{OUT1} = 1.3A
	Channel 2: V _{IN} = 12V, V _{OUT2} = 3.3V, f _{SW} = 1 MHz	I _{OUT2} = 850mA
	Channel 1: V _{IN} = 12V, V _{OUT1} = 1.8V, f _{SW} = 2 MHz	I _{OUT1} = 800mA
	Channel 2: V _{IN} = 12V, V _{OUT2} = 3.3V, f _{SW} = 2 MHz	I _{OUT2} = 500mA
Phase	Phase Pin = INTV _{CC}	Out-of-Phase
	Phase Pin = GND	In Phase
INTV _{CC}		3.3V
V2P5		2.5V

QUICK START PROCEDURE

The DC1895 is easy to set up to evaluate the performance of the LTC3633A. For a proper measurement equipment configuration, set up the circuit according to the diagram in Figure 1.

NOTE: When measuring the input or output voltage ripple, care must be taken to avoid a long ground lead on the oscilloscope probe. Measure the input or output voltage ripple by touching the probe tip directly across the V_{IN} or V_{OUT} and GND terminals. See the proper scope probe technique in Figure 2.

Please follow the procedure outlined below for proper operation.

1. Connect the input power supply to the V_{IN} and GND terminals. Connect the loads between the V_{OUT} and GND terminals. Refer to Figure 1 for the proper measurement equipment setup.

Before proceeding to operation, insert jumper shunts XJP1 and XJP2 into the OFF positions of headers JP1 and JP2, shunt XJP11 into the ON position (180° out-of-phase) of PHASE header JP11, shunts XJP3 and XJP4 into the soft-start (ss) positions of headers JP3 and JP4, shunt XJP8 into the forced continuous mode (FCM) position of MODE header JP8, shunt XJP14 into the 1MHz position of the frequency (FREQ) header JP14, shunts XJP12 and XJP13 into the external (EXT) compensation positions of headers JP12 and JP13, and shunt XJP6 into the V_{OUT1} voltage options of choice of header JP6: 1.2V, 1.5V, or 1.8V, and a shunt into the V_{OUT2} voltage option of choice: 2.5V (header JP15), 3.3V (header JP5), or 5V (header JP7).

2. Apply 5.5V at V_{IN} . Measure both V_{OUTS} ; they should read 0V. If desired, one can measure the shutdown supply current at this point. The supply current will be less than 100 μ A in shutdown.

3. Turn on V_{OUT1} and V_{OUT2} by shifting shunts XJP1 and XJP2 from the OFF positions to the ON positions. Both output voltages should be within a tolerance of $\pm 2\%$.
4. Vary the input voltage from 5.8V (the minimum V_{IN} is dependent on V_{OUT}) to 20V, and the load currents from 0A to 3A. Both output voltages should be within $\pm 4\%$ tolerance.
5. Set the load current of both outputs to 3A and the input voltage to 20V, and then measure each output ripple voltage (refer to Figure 2 for proper measurement technique); they should each measure less than 30mVAC. Also, observe the voltage waveforms at the switch nodes (Pins 23 and 24 for reg.1 and 13 and 14 for reg.2) of each regulator. The switching frequencies should be between 800kHz and 1.2MHz ($t = 1.25\mu$ s and 0.833 μ s). To realize 2MHz operation, change the shunt position on header JP14. In all cases, both switch node waveforms should be rectangular in shape, and 180° out-of-phase with each other. Change the shunt position on header JP11 to set the switch waveforms in phase with respect to each other. To operate the ckt.s in Burst Mode Operation, change the shunt in header JP8 to the Burst Mode position. When finished, insert shunts XJP1 and XJP2 to the OFF position(s) and disconnect the power.

Warning: If the power for the demo board is carried in long leads, the input voltage at the part could “ring”, which could affect the operation of the circuit or even exceed the maximum voltage rating of the IC. To eliminate the ringing, a small tantalum capacitor (for instance, AVX part number TPSY226M035R0200) is inserted on the pads between the input power and return terminals on the bottom of the demo board. The (greater) ESR of the tantalum will dampen the (possible) ringing voltage due to the use of long input leads. On a normal, typical PCB, with short traces, this capacitor is not needed.

QUICK START PROCEDURE

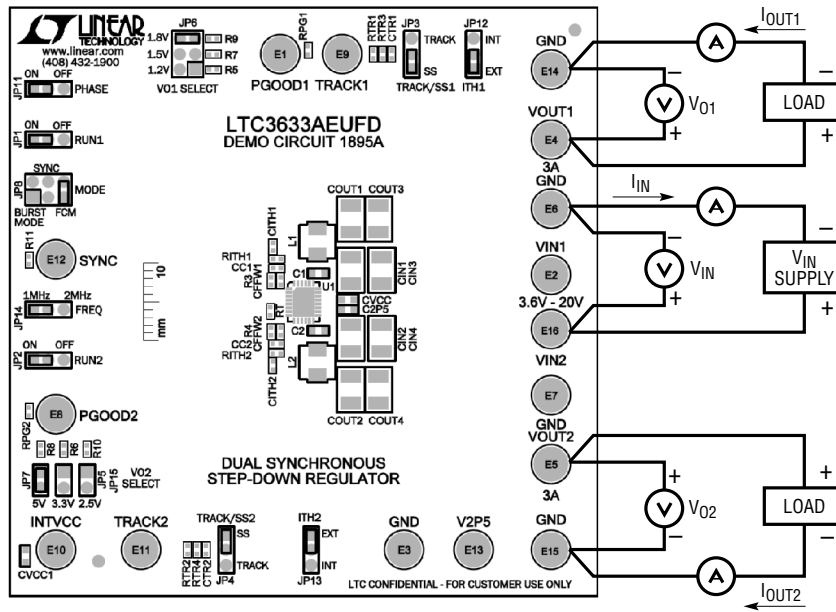

dc1895af F01

Figure 1. Proper Measurement Equipment Setup

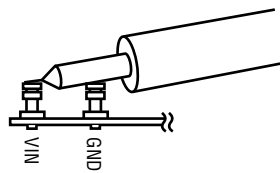
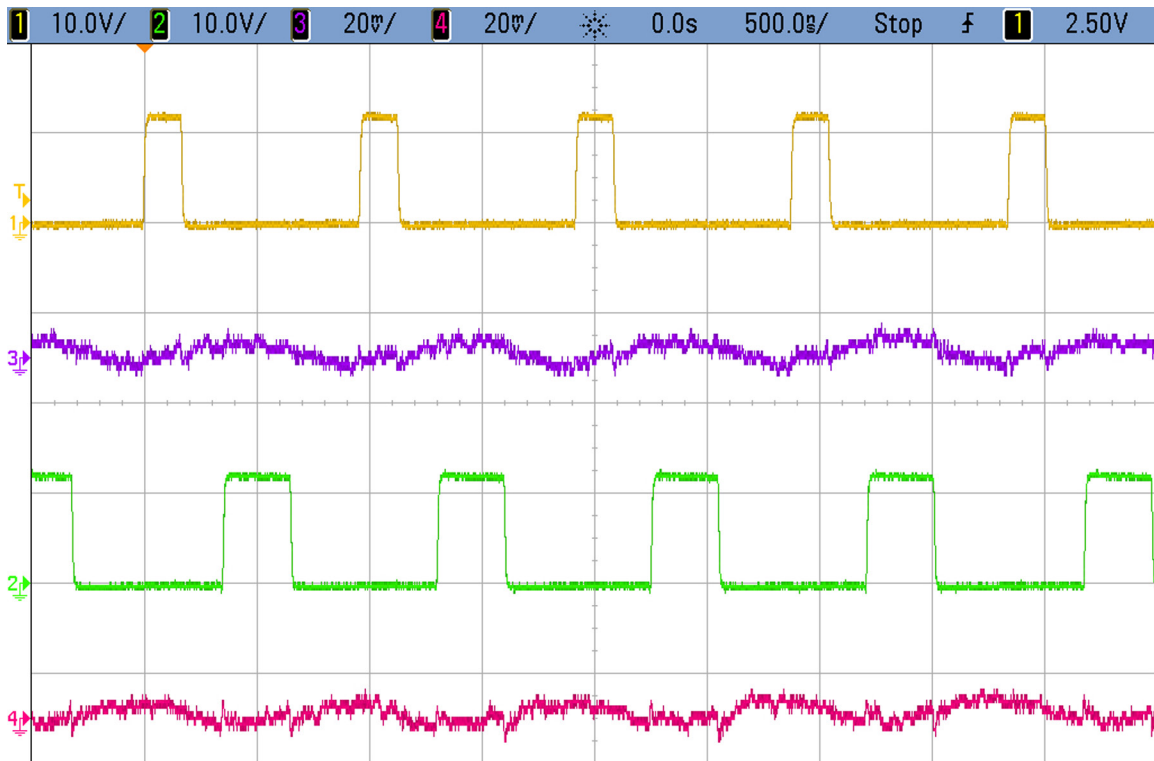

Figure 2. Measuring Input or Output Ripple

QUICK START PROCEDURE



$V_{IN} = 12V$, $V_{OUT1} = 1.8V$ at $I_{OUT1} = 3A$, $V_{OUT2} = 3.3V$ at $I_{OUT2} = 3A$

FORCED CONTINUOUS MODE $f_{SW} = 1MHz$

EXTERNAL COMPENSATION: $R_{ITHX} = 13k$, $C_{ITHX} = 220pF$

TRACE 1: V_{OUT1} (10V/DIV)

TRACE 3: V_{OUT1} AC VOLTAGE (20mV/DIV AC)

TRACE 2: V_{OUT2} (10V/DIV)

TRACE 4: V_{OUT2} AC VOLTAGE (20mV/DIV AC)

Figure 3. LTC3633A Switch Operation

QUICK START PROCEDURE

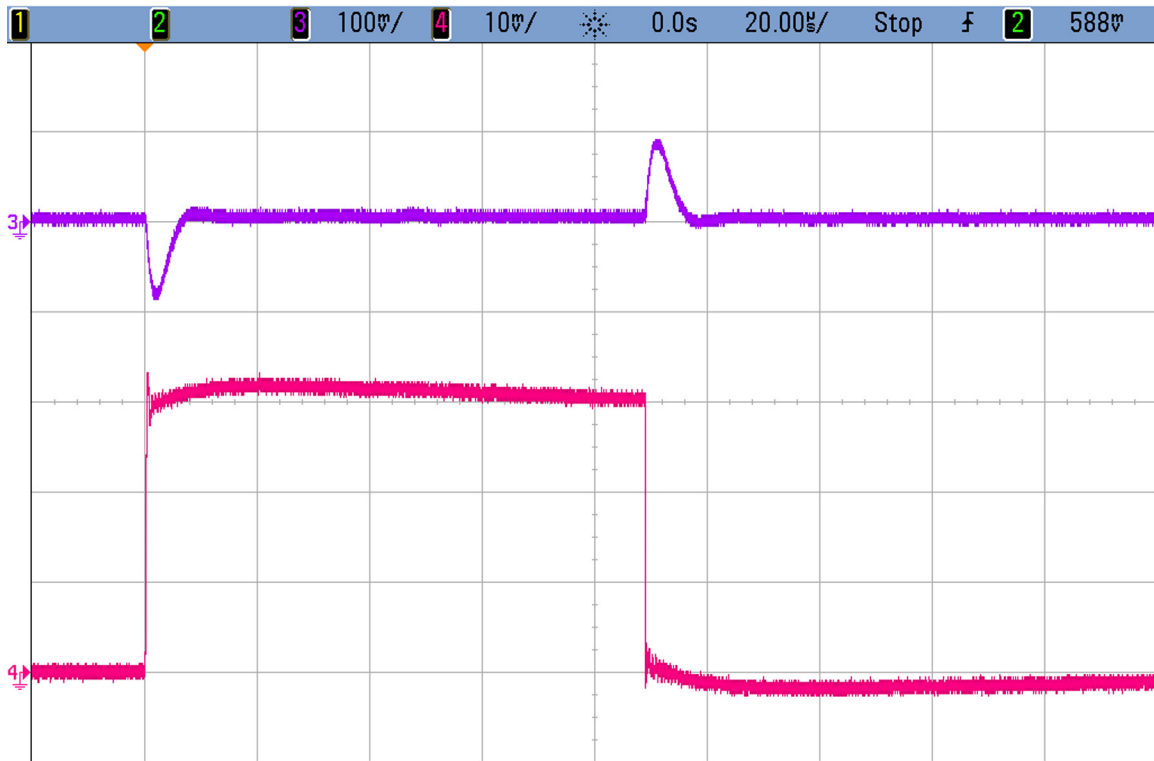

$V_{IN} = 12V$, $V_{OUT1} = 1.8V$, 3A LOAD STEP (0A < to > 3A)
 FORCED CONTINUOUS MODE $f_{SW} = 2MHz$
 EXTERNAL COMPENSATION: $R_{ITH} = 13k$, $C_{ITH} = 220pF$
 TRACE 3: OUTPUT VOLTAGE (100mV/DIV AC)
 TRACE 4: OUTPUT CURRENT (1A/DIV)

Figure 4. V_{OUT1} Load Step Response

QUICK START PROCEDURE

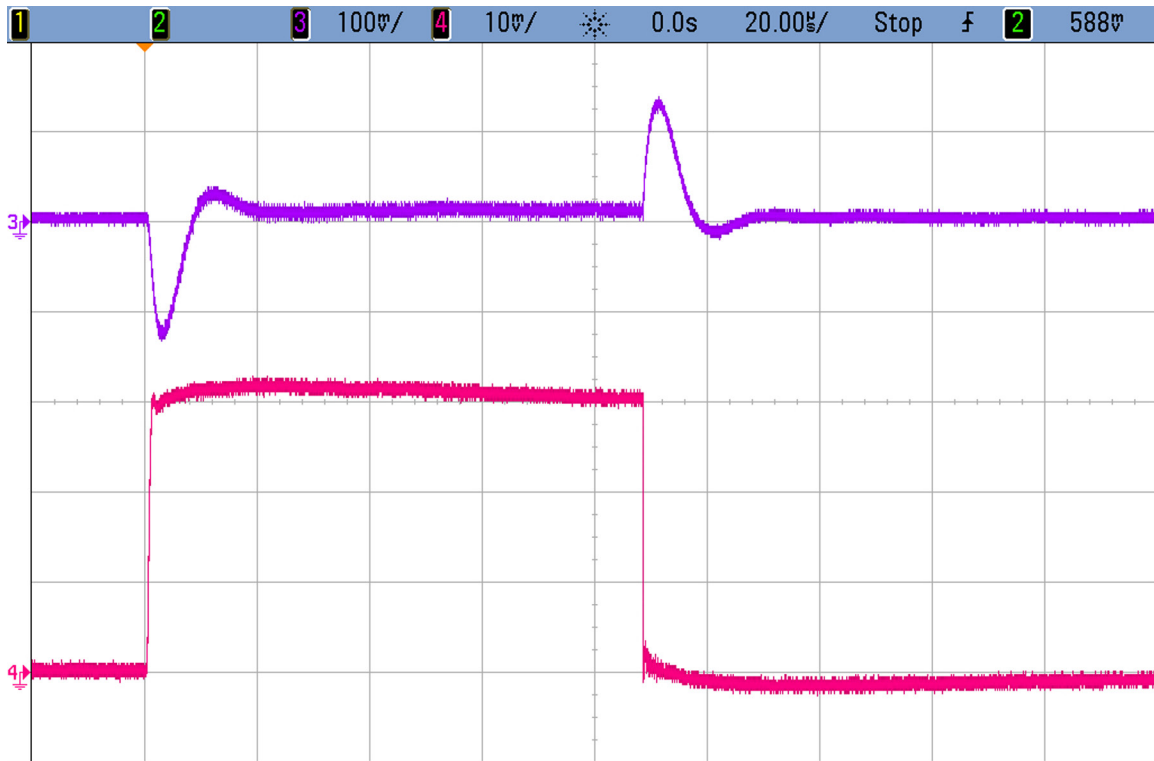

$V_{IN} = 12V$, $V_{OUT2} = 3.3V$, 3A LOAD STEP (0A < to > 3A)
FORCED CONTINUOUS MODE $f_{SW} = 2MHz$
EXTERNAL COMPENSATION: $R_{ITH} = 13k$, $C_{ITH} = 220pF$
TRACE 3: OUTPUT VOLTAGE (100mV/DIV AC)
TRACE 4: OUTPUT CURRENT (1A/DIV)

Figure 5. V_{OUT2} Load Step Response

QUICK START PROCEDURE

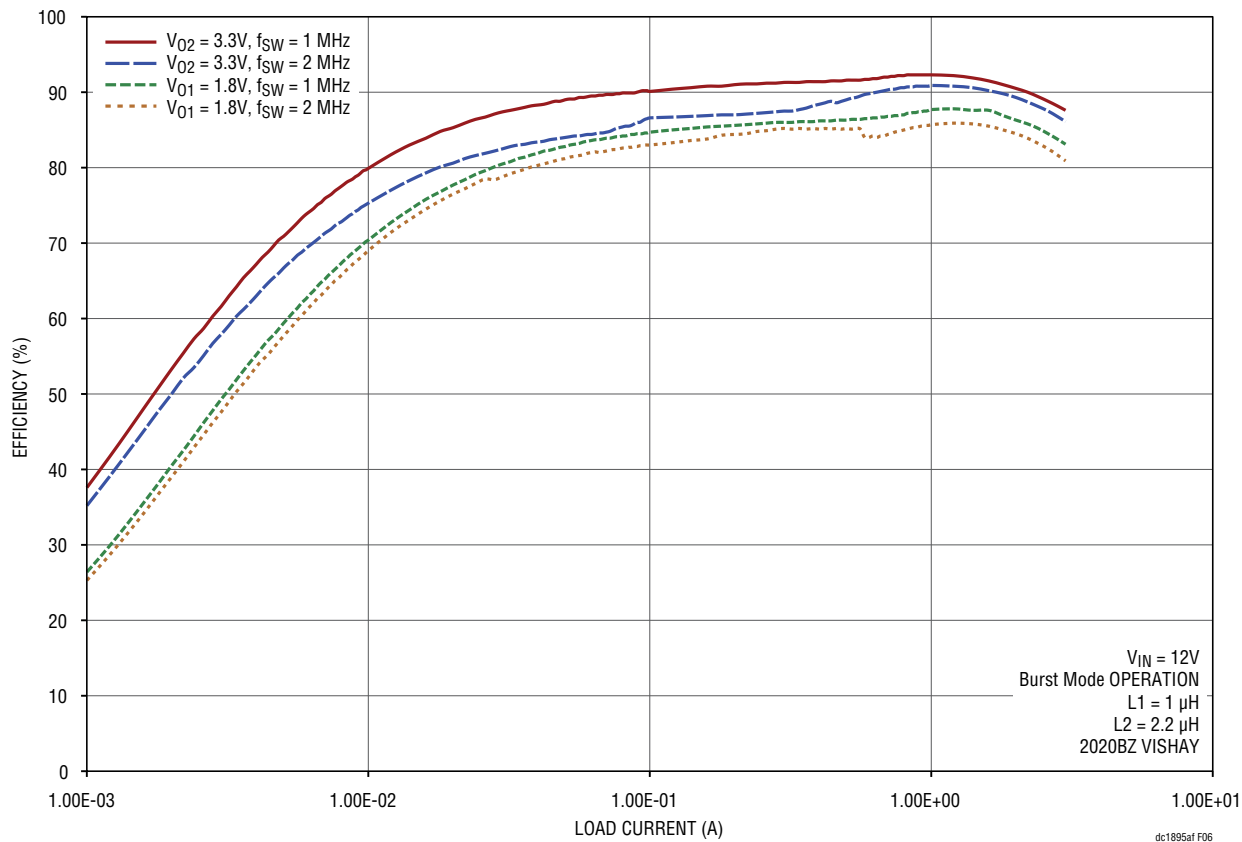

Figure 6. LTC3633A DC1895 Efficiency

DEMO MANUAL DC1895A

PARTS LIST

ITEM	QTY	REFERENCE	PART DESCRIPTION	MANUFACTURER/PART NUMBER
Required Circuit Components				
1	2	C1, C2	CAP, 0603, 0.1 μ F, 10%, 50V, X7R	TDK C1608X7R1H104K
2	2	CFFW1, CFFW2	CAP, 0402, 10pF, 5%, 25V, NPO	AVX 04023A100JAT2A
3	4	C _{IN1} to C _{IN4}	CAP, 1210, 22 μ F, 20%, 25V, X7R	TAIYO YUDEN TMK325B7226MM-TR
4	4	C _{OUT1} to C _{OUT4}	CAP, 1206, 22 μ F, 20%, 6.3V, X5R	TAIYO YUDEN JMK316BJ226ML-T
5	1	C _{VCC}	CAP, 0603, 1 μ F, 10%, 16V, X5R	AVX 0603YD105KAT2A
6	1	L1	IND, 1.0 μ H	VISHAY IHLP-2020BZER1R0M01
7	1	L2	IND, 2.2 μ H	VISHAY IHLP-2020BZER2R2M01
8	2	R3, R5	RES, 0402, 29.4k Ω , 1%, 1/16W	VISHAY CRCW040229K4FKED
9	1	R4	RES, 0402, 84.5k Ω , 1%, 1/16W	VISHAY CRCW040284K5FKED
10	1	R8	RES, 0402, 11.5k Ω , 1%, 1/16W	VISHAY CRCW040211K5FKED
11	1	U1	IC, DUAL STEP-DOWN REGULATOR	LINEAR TECH, LTC3633AEUFD
Additional Demo Board Circuit Components				
1	0	CC1, CC2	CAP, 0402, 10pF, 5%, 25V, NPO OPTION	AVX 04023A100JAT2A OPTION
2	2	C _{IN5} , C _{IN6}	CAP, 603, 2 3.3 μ F, 20%, 35V TANT	AVX TAJW335M035R
3	2	C _{ITH1} , C _{ITH2}	CAP, 0402, 220pF, 10%, 25V COG	AVX 04023A221KAT2A
4	0	CLD0	CAP, 0603, 1 μ F, 10%, 16V, X5R OPTION	AVX 0603YD105KAT2A OPTION
5	2	C _{OUT5} , C _{OUT6}	CAP, 0805, 10 μ F, 20%, 6.3V, X5R	TDK C2012X5R0J106M
6	2	CTR1, CTR2	CAP, 0402, 4700pF, 10%, 50V, X7R	AVX 04025C472KAT
7	2	C _{VCC1} , C2P5	CAP, 0603, 1 μ F, 10%, 16V, X5R	AVX 0603YD105KAT2A
8	2	C2P5, C _{VCC1}	CAP, 0603, 1 μ F, 10%, 16V, X5R	AVX 0603YD105KAT2A
9	2	R _{ITH1} , R _{ITH2}	RES, 0402, 13k Ω , 1%, 1/16W	NIC NRC04F1302TRF
10	2	RPG1, RPG2	RES, 0402, 100k Ω , 5%, 1/16W	VISHAY CRCW0402100KJNED
11	3	R1, R2, RPHMDE	RES, 0402, 1M Ω , 5%, 1/16W	VISHAY CRCW04021M00JNED
12	1	R _T	RES, 0402, 324k Ω , 1%, 1/16W	VISHAY CRCW0402324KFKED
13	2	RTR1, RTR2	RES, 0402, 0 Ω , JUMPER	VISHAY CRCW04020000Z0ED
14	0	RTR3, RTR4	RES, 0402, OPTION	OPTION
15	1	R6	RES, 0402, 18.7k Ω , 1%, 1/16W	VISHAY CRCW040218K7FKED
16	1	R7	RES, 0402, 19.6k Ω , 1%, 1/16W	VISHAY CRCW040219K6FKED
17	1	R9	RES, 0402, 14.7k Ω , 1%, 1/16W	VISHAY CRCW040214K7FKED
18	1	R10	RES, 0402, 26.7k Ω , 1%, 1/16W	VISHAY CRCW040226K7FKED
19	1	R11	RES, 0402, 10k Ω , 5%, 1/16W	VISHAY CRCW040210K0JNED
Hardware: For Demo Board Only				
1	16	E1 to E16	TURRET	MILL-MAX 2501-2-00-80-00-00-07-0
2	8	JP1 to JP4, JP11 to JP14	HEADER, 3Pin, 2mm	SULLINS, NRPNO31PAEN-RC
3	3	JP5, JP7, JP15	HEADER, 2Pin, 2mm	SULLINS, NRPNO21PAEN-RC
4	2	JP6, JP8	HEADER, 3Pin, DBL ROW 2mm	SULLINS, NRPNO32PAEN-RC
5	11	JP1 to JP4, JP6 to JP8, JP11 to JP14	SHUNT, 2mm	SAMTEC 2SN-BK-G

SCHEMATIC DIAGRAM

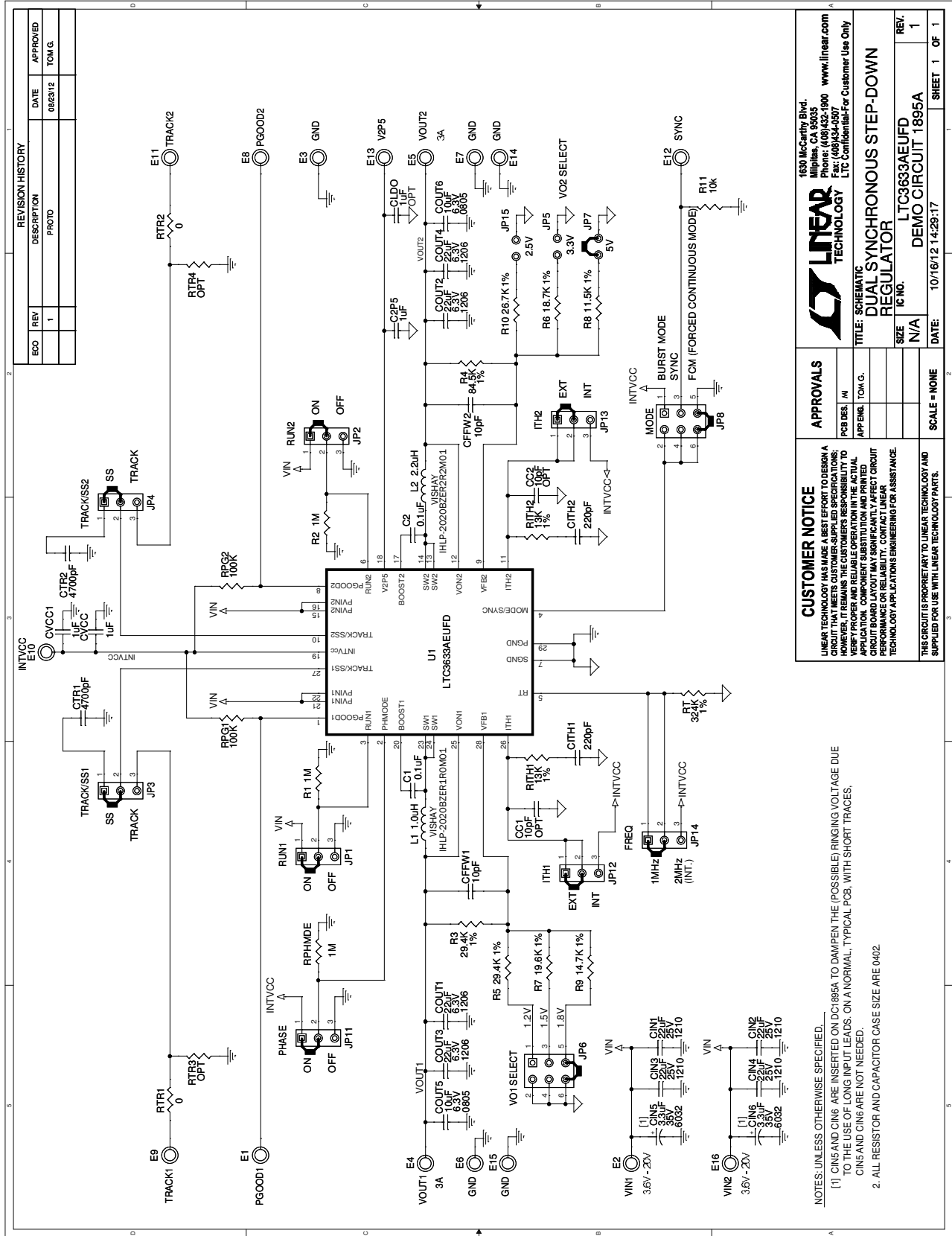

DEMO MANUAL DC1895A

DEMONSTRATION BOARD IMPORTANT NOTICE

Linear Technology Corporation (LTC) provides the enclosed product(s) under the following **AS IS** conditions:

This demonstration board (DEMO BOARD) kit being sold or provided by Linear Technology is intended for use for **ENGINEERING DEVELOPMENT OR EVALUATION PURPOSES ONLY** and is not provided by LTC for commercial use. As such, the DEMO BOARD herein may not be complete in terms of required design-, marketing-, and/or manufacturing-related protective considerations, including but not limited to product safety measures typically found in finished commercial goods. As a prototype, this product does not fall within the scope of the European Union directive on electromagnetic compatibility and therefore may or may not meet the technical requirements of the directive, or other regulations.

If this evaluation kit does not meet the specifications recited in the DEMO BOARD manual the kit may be returned within 30 days from the date of delivery for a full refund. **THE FOREGOING WARRANTY IS THE EXCLUSIVE WARRANTY MADE BY THE SELLER TO BUYER AND IS IN LIEU OF ALL OTHER WARRANTIES, EXPRESSED, IMPLIED, OR STATUTORY, INCLUDING ANY WARRANTY OF MERCHANTABILITY OR FITNESS FOR ANY PARTICULAR PURPOSE. EXCEPT TO THE EXTENT OF THIS INDEMNITY, NEITHER PARTY SHALL BE LIABLE TO THE OTHER FOR ANY INDIRECT, SPECIAL, INCIDENTAL, OR CONSEQUENTIAL DAMAGES.**

The user assumes all responsibility and liability for proper and safe handling of the goods. Further, the user releases LTC from all claims arising from the handling or use of the goods. Due to the open construction of the product, it is the user's responsibility to take any and all appropriate precautions with regard to electrostatic discharge. Also be aware that the products herein may not be regulatory compliant or agency certified (FCC, UL, CE, etc.).

No License is granted under any patent right or other intellectual property whatsoever. **LTC assumes no liability for applications assistance, customer product design, software performance, or infringement of patents or any other intellectual property rights of any kind.**

LTC currently services a variety of customers for products around the world, and therefore this transaction **is not exclusive**.

Please read the DEMO BOARD manual prior to handling the product. Persons handling this product must have electronics training and observe good laboratory practice standards. **Common sense is encouraged.**

This notice contains important safety information about temperatures and voltages. For further safety concerns, please contact a LTC application engineer.

Mailing Address:

Linear Technology
1630 McCarthy Blvd.
Milpitas, CA 95035

Copyright © 2004, Linear Technology Corporation

X-ON Electronics

Largest Supplier of Electrical and Electronic Components

Click to view similar products for [Power Management IC Development Tools](#) category:

Click to view products by [Analog Devices](#) manufacturer:

Other Similar products are found below :

[EVAL-ADM1168LQEBZ](#) [EVB-EP5348UI](#) [MIC23451-AAAYFL EV](#) [MIC5281YMME EV](#) [DA9063-EVAL](#) [ADP122-3.3-EVALZ](#) [ADP130-0.8-EVALZ](#) [ADP130-1.2-EVALZ](#) [ADP130-1.5-EVALZ](#) [ADP130-1.8-EVALZ](#) [ADP1714-3.3-EVALZ](#) [ADP1716-2.5-EVALZ](#) [ADP1740-1.5-EVALZ](#) [ADP1752-1.5-EVALZ](#) [ADP1828LC-EVALZ](#) [ADP1870-0.3-EVALZ](#) [ADP1871-0.6-EVALZ](#) [ADP1873-0.6-EVALZ](#) [ADP1874-0.3-EVALZ](#) [ADP1882-1.0-EVALZ](#) [ADP199CB-EVALZ](#) [ADP2102-1.25-EVALZ](#) [ADP2102-1.875EVALZ](#) [ADP2102-1.8-EVALZ](#) [ADP2102-2-EVALZ](#) [ADP2102-3-EVALZ](#) [ADP2102-4-EVALZ](#) [ADP2106-1.8-EVALZ](#) [ADP2147CB-110EVALZ](#) [AS3606-DB](#) [BQ24010EVM](#) [BQ24075TEVM](#) [BQ24155EVM](#) [BQ24157EVM-697](#) [BQ24160EVM-742](#) [BQ24296MEVM-655](#) [BQ25010EVM](#) [BQ3055EVM](#) [NCV891330PD50GEVB](#) [ISLUSBI2CKIT1Z](#) [LM2744EVAL](#) [LM2854EVAL](#) [LM3658SD-AEV/NOPB](#) [LM3658SDEV/NOPB](#) [LM3691TL-1.8EV/NOPB](#) [LM4510SDEV/NOPB](#) [LM5033SD-EVAL](#) [LP38512TS-1.8EV](#) [EVAL-ADM1186-1MBZ](#) [EVAL-ADM1186-2MBZ](#)