

## LTM4676AEY Dual 13A or Single 26A $\mu$ Module Regulator with Digital Power System Management 2x LTM4676A, 50A

### DESCRIPTION

Demonstration circuit 1989B-A is a high efficiency, high density,  $\mu$ Module regulator with 4.5V to 17V input range. The output voltage is adjustable from 0.5V to 4V, and it can supply 50A maximum load current. The demo board has two LTM<sup>®</sup>4676A  $\mu$ Module regulators, and the LTM4676A is a dual 13A or single 26A step-down regulator with PMBus power system management. Please see LTM4676A data sheet for more detailed information

DC1989B-A powers up to default settings and produces power based on configuration resistors without the need for any serial bus communication. This allows easy evaluation of the DC/DC converter. To fully explore the extensive power system management features of the part, download the GUI software LTpowerPlay™ onto your PC and use LTC's I<sup>2</sup>C/SMBus/PMBus dongle DC1613A to connect to

the board. LTpowerPlay allows the user to reconfigure the part on the fly and store the configuration in EEPROM, view telemetry of voltage, current, temperature and fault status

### GUI Download

The software can be downloaded from:

<http://www.linear.com/ltpowerplay>

For more details and instructions of LTpowerPlay, please refer to LTpowerPlay GUI for LTM4676A Quick Start Guide.

**Design files for this circuit board are available at <http://www.linear.com/demo/DC1989B-A>**

LT, LT, LTC, LTM, Linear Technology, the Linear logo, Burst Mode, Dust Networks and Dust are registered trademarks of Linear Technology Corporation. All other trademarks are the property of their respective owners.

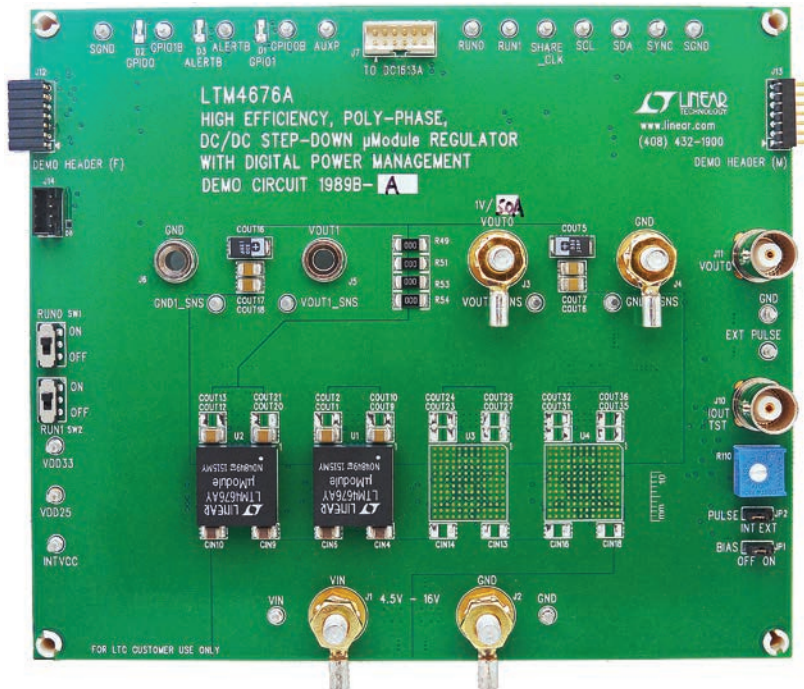

Figure 1. 2x LTM4676A; 50A DC1989B-A Demo Circuit

# DEMO MANUAL DC1989B-A

## PERFORMANCE SUMMARY Specifications are at $T_A = 25^\circ\text{C}$

PARAMETER	CONDITION	VALUE
Input Voltage Range		4.5V to 17V
Output Voltage, $V_{OUT0}$	$V_{IN} = 4.5$ to 17V, $I_{OUT0} = 0\text{A}$ to 50A	0.5 to 4V, Default: 1V
Maximum Output Current, $I_{OUT0}$	$V_{IN} = 4.5$ to 17V, $V_{OUT} = 0.5\text{V}$ to 4V	50A
Typical Efficiency	$V_{IN} = 12\text{V}$ , $V_{OUT} = 1\text{V}$ , $I_{OUT} = 50\text{A}$	80.4%
Default Switching Frequency		350kHz

## QUICK START PROCEDURE

Demonstration circuit 1989B-A is easy to set up to evaluate the performance of the LTM4676AEY. Refer to Figure 2 for the proper measurement equipment setup and follow the procedure below.

1. With power off, connect the input power supply to  $V_{IN}$  (4.5V to 17V) and GND (input return).
2. Connect the output load between  $V_{OUT0}$  and GND (Initial load: no load).
3. Connect the DVMs to the input and outputs. Set default switch position: SW1: ON; SW2: ON.
4. Turn on the input power supply and check for the proper output voltages.  $V_{OUT0}$  should be  $1\text{V} \pm 1\%$ .
5. Once the proper output voltages are established, adjust the loads within the operating range and observe the output voltage regulation, ripple voltage and other parameters.

6. Connect the dongle and control the output voltages from the GUI. See “LTpowerPlay GUI for the LTM4676A Quick Start Guide” for details.

Note: When measuring the output or input voltage ripple, do not use the long ground lead on the oscilloscope probe. See Figure 3 for the proper scope probe technique. Short, stiff leads need to be soldered to the (+) and (-) terminals of an output capacitor. The probe’s ground ring needs to touch the (-) lead and the probe tip needs to touch the (+) lead.

### Connecting a PC to DC1989B-A

You can use a PC to reconfigure the power management features of the LTM4676A such as: nominal  $V_{OUT}$ , margin set points, OV/UV limits, temperature fault limits, sequencing parameters, the fault log, fault responses, GPIOs and other functionality. The DC1613A dongle may be plugged when  $V_{IN}$  is present.

Table 1. LTM4676/LTM4676A Demo Cards for Up to 130A Point-of-Load Regulation

MAXIMUM OUTPUT CURRENT	NUMBER OF OUTPUT VOLTAGES	NUMBER OF LTM4676/LTM4676A $\mu$ MODULE REGULATORS ON THE BOARD	DEMO BOARD NUMBER
13A, 13A	2	1× LTM4676	DC1811A/DC1811B-A
13A, 13A	2	1× LTM4676A	DC1811B-B
26A	1	1× LTM4676	DC2087A
50A	1	2× LTM4676A	DC1989B-A
75A	1	3× LTM4676A	DC1989B-B
100A	1	4× LTM4676A	DC1989B-C
100A	1	1× LTM4676 (+ 3× LTM4620A)	DC2106A-A
130A	1	1× LTM4676 (+ 3× LTM4630)	DC2106A-B
100A	1	1× LTM4676A (+ 3× LTM4620A)	DC2106B-A
130A	1	1× LTM4676A (+ 3× LTM4630)	DC2106B-B

QUICK START PROCEDURE

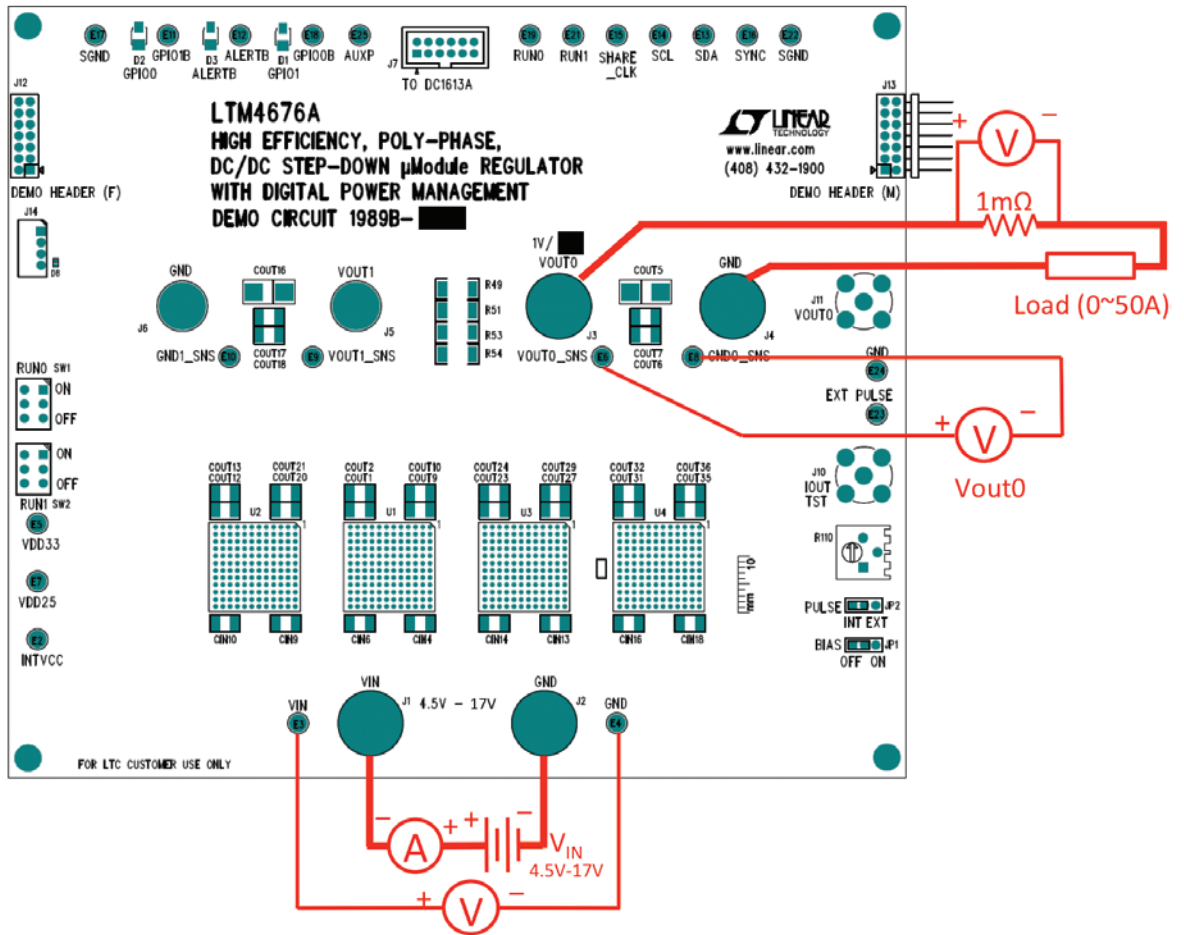

Figure 2. Proper Measurement Equipment Setup

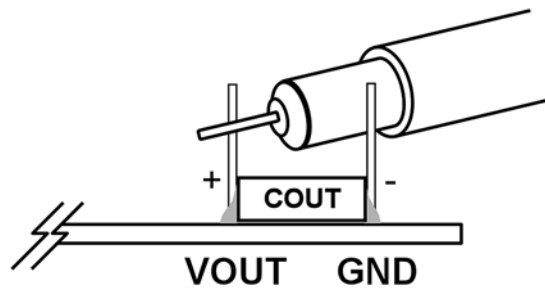

Figure 3. Measuring Output Voltage Ripple

## QUICK START PROCEDURE

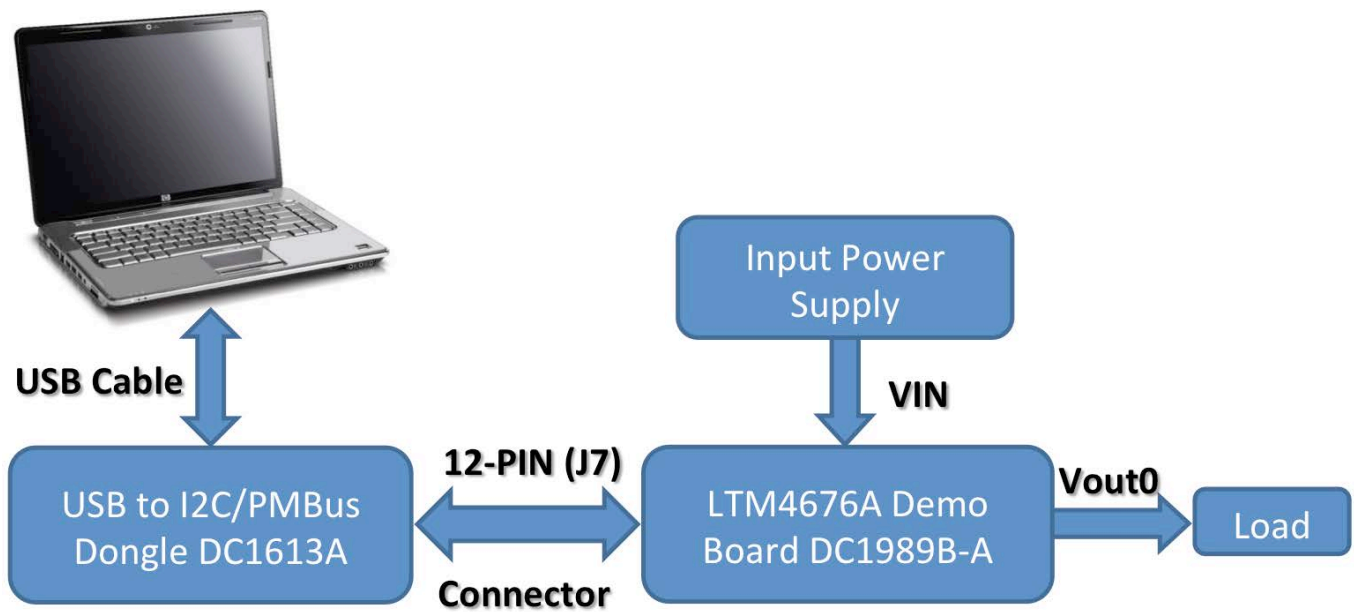

Figure 4. Demo Setup with PC

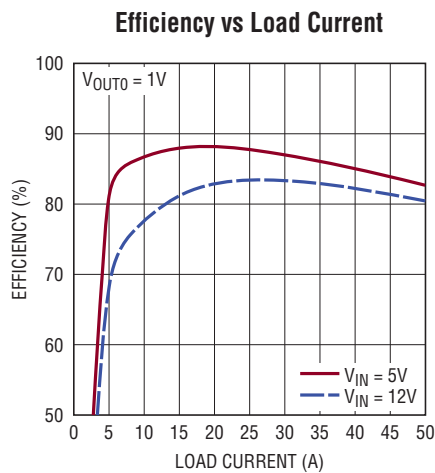
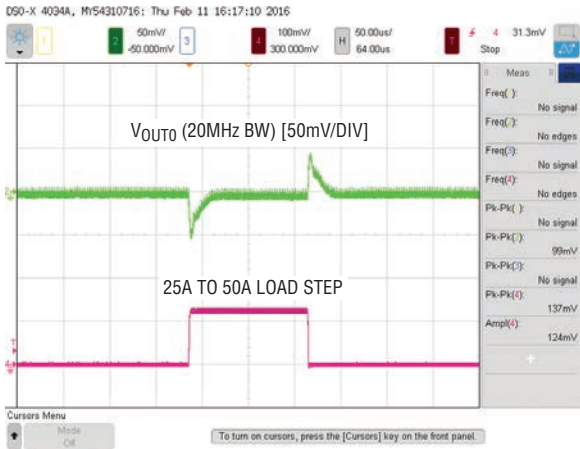
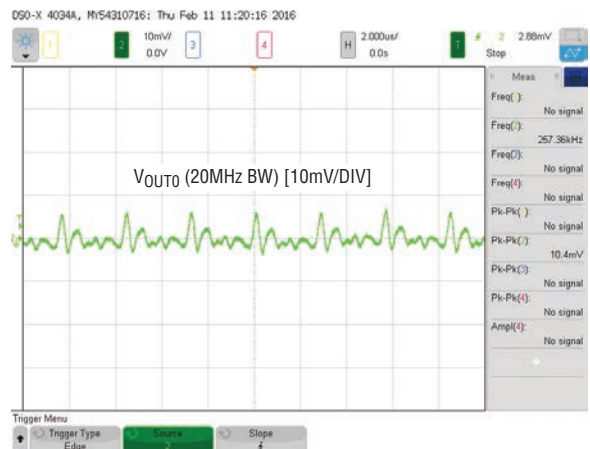

Figure 5. Efficiency vs Load Current at  $V_{IN} = 5V$  and  $V_{IN} = 12V$

**QUICK START PROCEDURE**



**Figure 6. Output Voltage  $V_{OUT0}$  vs Load Current ( $V_{OUT0}$  RANGE = 1)**



**Figure 7. Output Voltage Ripple at  $V_{IN} = 12V$ ,  $V_{OUT0} = 1V$ ,  $I_{OUT0} = 50A$**

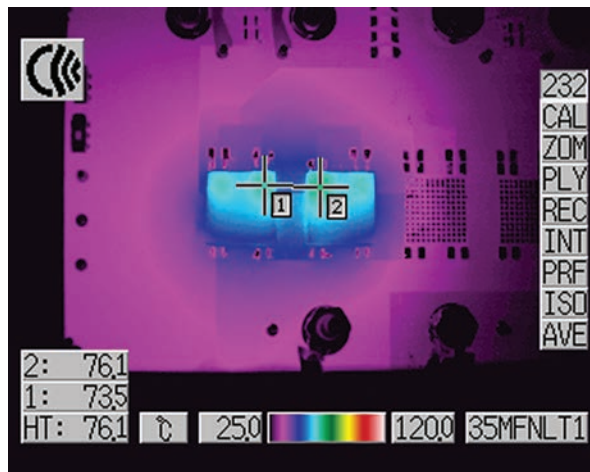

**Figure 8. Thermal Performance at  $V_{IN} = 12V$ ,  $V_{OUT0} = 1V$ ,  $I_{OUT0} = 50A$ ,  $T_A = 23.8^\circ C$ , Air Flow 200LFM**

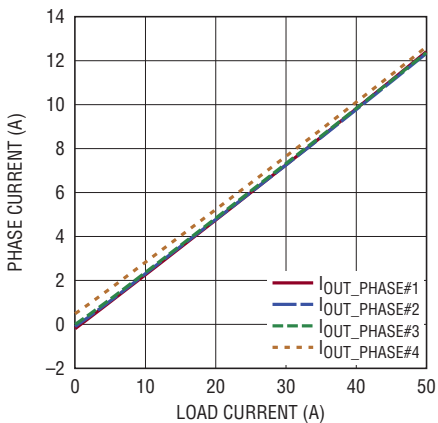

**Figure 9. Current Sharing at  $V_{IN} = 12V$ ,  $V_{OUT0} = 1V$  (Based on the Current Readback)**

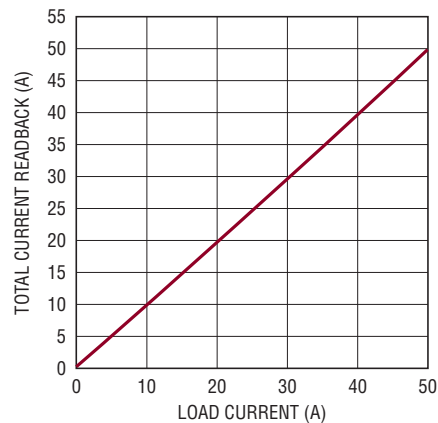

**Figure 10. Total Current Readback vs Load Current at  $V_{IN} = 12V$ ,  $V_{OUT0} = 1V$**



## QUICK START PROCEDURE

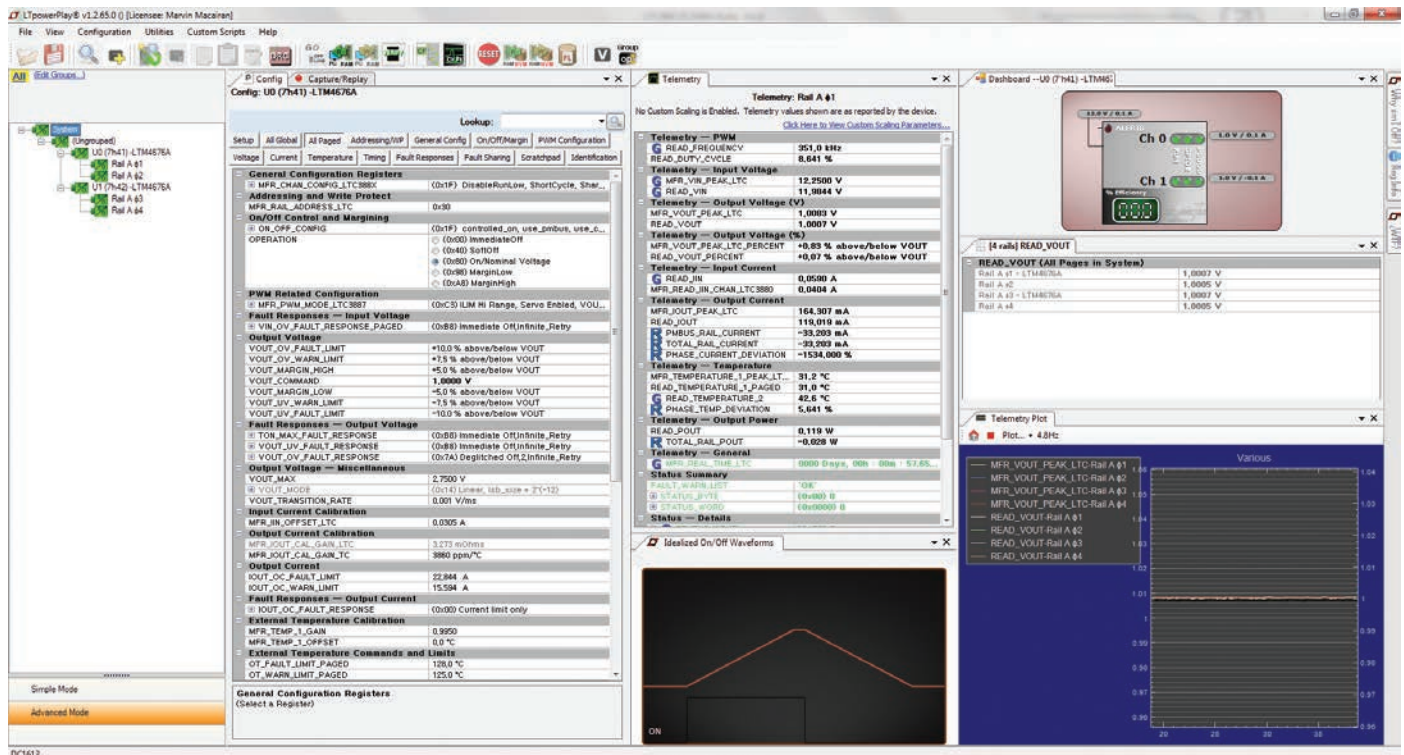

Figure 11. LTpowerPlay Main Interface

### LTpowerPlay Software GUI

LTpowerPlay is a powerful Windows based development environment that supports Linear Technology power system management ICs, including the LTM4676A, LTC3880, LTC3883, LTC2974 and LTC2978. The software supports a variety of different tasks. You can use LTpowerPlay to evaluate Linear Technology ICs by connecting to a demo board system. LTpowerPlay can also be used in an offline mode (with no hardware present) in order to build a multichip configuration file that can be saved and reloaded at a later time. LTpowerPlay provides unprecedented diagnostic and debug features. It becomes a valuable diagnostic tool during board bring-up to program or tweak the power management scheme in a system, or to diagnose power issues when bringing up rails. LTpowerPlay utilizes the DC1613A USB-to-SMBus controller to communicate with one of many potential targets, including the LTM4676A, the

LTC3880 and the LTC3883's demo system, or a customer board. The software also provides an automatic update feature to keep the software current with the latest set of device drivers and documentation. The LTpowerPlay software can be downloaded from:

<http://linear.com/ltpowerplay>

To access technical support documents for LTC Digital Power Products visit Help. View online help on the LTpowerPlay menu.

### LTpowerPlay QUICK START PROCEDURE

The following procedure describes how to use LTpowerPlay to monitor and change the settings of LTM4676A.

1. Download and install the LTpowerPlay GUI:

<http://linear.com/ltpowerplay>

## QUICK START PROCEDURE

2. Launch the LTpowerPlay GUI.

- a. The GUI should automatically identify the DC1989B-A. The system tree on the left hand side should look like this:

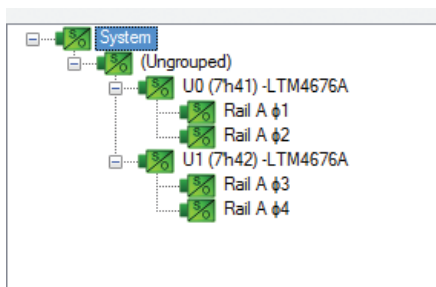

- b. A green message box shows for a few seconds in the lower left hand corner, confirming that LTM4676A is communicating:

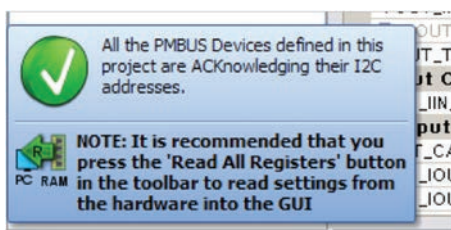

- c. In the Toolbar, click the “R” (RAM to PC) icon to read the RAM from the LTM4676A. This reads the configuration from the RAM of LTM4676A and loads it into the GUI.



- d. If you want to change the output voltage to a different value, like 1.5V. In the Config tab, type in 1.5 in the VOUT\_COMMAND box, like this:

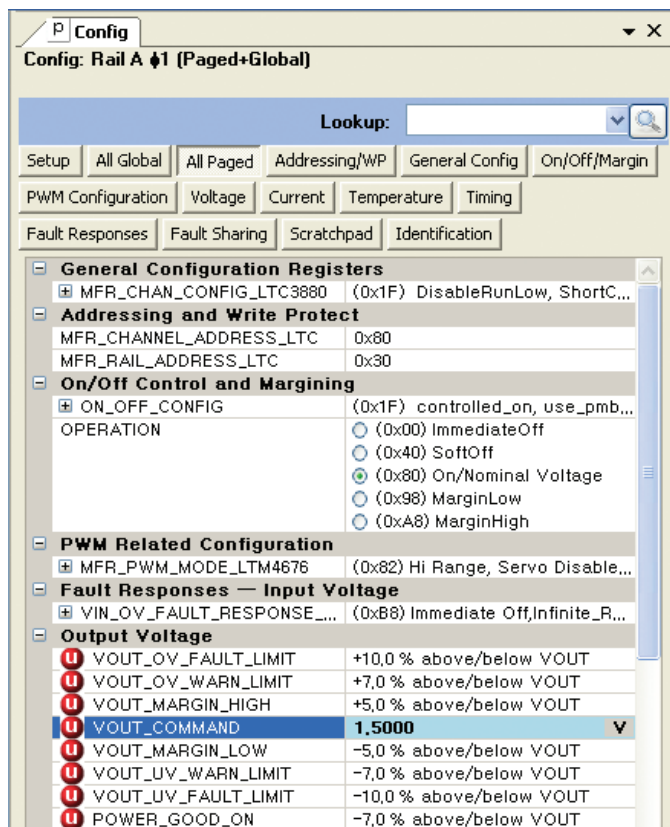

Then, click the “W” (PC to RAM) icon to write these register values to the LTM4676A. After finishing this step, you will see the output voltage will change to 1.5V.



If the write is successful, you will see the following message:



- e. You can save the changes into the NVM. In the tool bar, click “RAM to NVM” button, as following



- f. Save the demo board configuration to a (\*.proj) file. Click the Save icon and save the file. Name it whatever you want.

# DEMO MANUAL DC1989B-A

## PARTS LIST

ITEM	QTY	REFERENCE	PART DESCRIPTION	MANUFACTURER/PART NUMBER
<b>Required Circuit Components</b>				
1	10	CIN1, CIN2, CIN4-CIN11	CAP., X5R, 10 $\mu$ F, 35V, 10%, 1210	AVX, 1210DD106KAT2A
2	1	CIN3	CAP., 150 $\mu$ F, 35V, ALUMINUM ELECTR.	SUN ELECTRONIC INDUSTRIES CORPORATION, 35CE150AX
3	10	COUT1, COUT6, COUT7, COUT9, COUT12, COUT17, COUT18, COUT20	CAP., X5R, 100 $\mu$ F, 6.3V, 20% 1210	AVX, 12106D107KAT2A
4	1	C3	CAP., X7R, 220pF, 16V, 10%, 0603	AVX, 0603YC221KAT2A
5	6	COUT4, COUT5, COUT8, COUT15, COUT16, COUT19	CAP., 330 $\mu$ F, 6.3V, POSCAP, D3L	PANASONIC, 6TPF330M9L
6	1	C7	CAP., X7R, 470pF, 25V, 10%, 0603	AVX, 06033C471KAT2A
7	1	C4	CAP., X7R, 3.3nF, 16V, 10%, 0603	AVX, 0603YC332KAT2A
8	1	C32	CAP., X5R, 100nF, 16V, 10%, 0603	AVX, 0603YD104KAT2A
9	1	C70	CAP., X5R, 1 $\mu$ F, 25V, 10%, 0805	AVX, 08053D105KAT2A
10	2	C65, C68	CAP., X5R, 1 $\mu$ F, 25V, 10%, 1206	AVX, 12063D105KAT2A
11	1	C67	CAP., X7R, 0.1 $\mu$ F, 25V, 10%, 1206	AVX, 12063C104KAT2A
12	1	C64	CAP., X5R, 4.7 $\mu$ F, 25V, 10%, 0603	MURATA, GRM188R61E475KE11D
13	1	C66	CAP., X5R, 0.22 $\mu$ F, 25V, 10%, 0805	AVX, 08053D224KAT2A
14	2	D1, D2	LED, 0603 GREEN	WURTH ELEKTRONIK 150060GS75000
15	1	D3	LED, 0603 RED	WURTH ELEKTRONIK 150060SS75000
16	1	D8	DIODE SCHOTTKY 20V 500MA SOD882	NXP SEMI. PMEG2005AEL
17	1	Q2	MOSFET P-CH 20V 5.9A TO-236	VISHAY SI2365EDS-T1-GE3
18	2	Q3, Q4	MOSFET N-CH 60V 115MA SOT-23	FAIRCHILD 2N7002K
19	2	Q11, Q12	XSTR, N-CH 40V 14A TO-252	VISHAY SUD50N04-8M8P-4GE3
27	1	Q19	P-CHANNEL 30-V MOSFET	DIODES INC., DMP3130L-7
28	1	R20	RES., CHIP, 22.6k, 1%, 0603	VISHAY CRCW060322K6FKEA
29	23	R2, R4, R18, R25, R26, R30, R32, R47, R48, R50, R56, R58, R60, R72, R74, R104, R119, R120, R121, R122, R131, R135, R143	RES., CHIP, 0 $\Omega$ , 1%, 0603	VISHAY CRCW06030000Z0EA
30	4	R49, R51, R53, R54	RES., CHIP, 0 $\Omega$ , 1%, 2010	VISHAY CRCW20100000Z0EF
31	15	R6, R7, R8, R9, R10, R11, R12, R15, R35, R36, R39, R64, R78, R116, R130	RES., CHIP, 10k, 1%, 0603	VISHAY CRCW060310K0FKEA
32	1	R14	RES., CHIP, 2.8k, 1%, 0603	VISHAY CRCW06032K80FKEA
33	2	R40, R42	RES., CHIP, 1.65k, 1%, 0603	VISHAY CRCW06031K65FKEA
34	2	R16, R41	RES., CHIP, 10 $\Omega$ , 1%, 0603	VISHAY CRCW060310R0FKEA
35	1	R112	RES., CHIP, 100 $\Omega$ , 1%, 0603	VISHAY CRCW0603100RFKEA
36	1	R113	RES., CHIP, 576 $\Omega$ , 1%, 0603	
37	1	R19	RES., CHIP, 787 $\Omega$ , 1%, 0603	PANASONIC ERJ-3EKF7870V
38	1	R27	RES., CHIP, 51k, 1%, 0603	VISHAY CRCW060351K0FKEA
39	1	R141	RES., CHIP, 15.8k, 1%, 0603	VISHAY CRCW060315K8FKEA
40	2	R134, R144	RES., CHIP, 4.99k, 1%, 0603	VISHAY CRCW06034K99FKEA
41	2	R85, R124	RES., CHIP, 200 $\Omega$ , 1%, 0603	VISHAY CRCW0603200RFKEA
42	1	R86	RES., CHIP, 127 $\Omega$ , 1%, 0603	VISHAY CRCW0603127RFKEA
43	1	R123	RES., CHIP, 1M, 1%, 0603	VISHAY CRCW06031M00FKEA
44	1	R105	RES., CHIP, 681k, 1%, 0603	VISHAY CRCW0603681KFKEA

dc1989baf



## PARTS LIST

ITEM	QTY	REFERENCE	PART DESCRIPTION	MANUFACTURER/PART NUMBER
45	1	R106	RES., CHIP, 3.3Ω, 1%, 0603	VISHAY CRCW06033R30FKEA
46	1	R107	RES., CHIP, 82.5Ω, 1%, 0603	VISHAY CRCW060382R5FKEA
47	2	R108, R118	RES., CHIP, 0.01Ω, 1%, 2010	VISHAY, WSL2010R0100FEA
48	1	R109	RES., CHIP, 100k, 1%, 0603	VISHAY CRCW0603100KFKEA
49	1	R110	TRIMMING POTENTIOMETER, 5k	BOURNS, 3386P-1-502LF
50	2	R111, R115	RES., CHIP, 20k, 1%, 0603	VISHAY CRCW060320K0FKEA
51	1	R114	RES., CHIP, 154k, 1%, 0603	VISHAY CRCW0603154KFKEA
52	1	R117	RES., CHIP, 2Ω, 1%, 0603	VISHAY CRCW06032R00FKEA
53	2	U1, U2	IC, LTM4676AEY	LINEAR TECH., LTM4676AEY#PBF
54	1	U9	IC, 24LC025T-I/ST SOT-23 6-LEAD	MICROCHIP, 24LC025T-I/ST
55	1	U6	IC., LT1129CS8-5, S8	LINEAR TECH. LT1129CS8-5#PBF
56	1	U7	IC., LTC6992-1, S6-TSOT	LINEAR TECH. LTC6992CS6-1#PBF
57	1	U8	IC., LT1803IS5, S5-TSOT	LINEAR TECH. LT1803IS5#PBF

### Additional Demo Board Circuit Components

1	0	COUT2, COUT3, COUT10, COUT11, CIN12-CIN19, COUT21-COUT25, COUT27, COUT29-COUT33, COUT35-COUT37, COUT26, COUT28, COUT34, COUT38, C1, C2, C6, C8-C20	CAP., OPTIONAL	
2	0	C69 OPT		
3	0	D4, D5	OPT SOD323	
4	0	R3, R5, R17, R33, R34, R38, R59, R61, R63, R73, R75, R77, R126, R127, R128, R132, R133, R136, R137, R139, R140, R142, R1, R13, R29, R37, R57, R62, R71, R76, R21, R22, R23, R24, R43, R44, R45, R46, R65, R66, R67, R68, R69, R70, R79-R84, R102, R103, R138	RES., OPTIONAL	
5	0	U3, U4	OPTIONAL	

### Hardware: For Demo Board Only

1	23	E2-E24	TESTPOINT, TURRET, 0.062"	MILL-MAX, 2308-2-00-80-00-00-07-0
2	2	JP1, JP2	HEADER, 1X3 PIN 0.079" SINGLE ROW	SULLIN, NRPN031PAEN-RC
3	2	XJP1, XJP2	SHUNT, 0.079" CENTER	SAMTEC, 2SN-KB-G
4	4	J1, J2, J3, J4	STUD, TESTPIN	PEM KFH-032-10
5	8	J1, J2, J3, J4 (x2)	NUT, BRASS 10-32	ANY #10-32
6	4	J1, J2, J3, J4	RING, LUG #10	KEYSTONE 8205
7	4	J1, J2, J3, J4	WASHER, TIN PLATED BRASS	ANY #10EXT BZ TN
8	2	J5, J6	JACK, BANANA	KEYSTONE 575-4
9	1	J7	CONN HEADER 12POS 2MM STR DL PCB	FCI 98414-G06-12ULF
10	1	J12	CONN RECEIPT 2MM DUAL R/A 14POS (F)	SULLINS, NPPN072FJFN-RC
11	1	J13	HEADER 14POS 2MM R/A GOLD (M)	MOLEX, 87760-1416
12	2	J10, J11	CONN, BNC, 5PINS	CONNEX, 112404
13	1	J14	HEADER, 4 PINS, SHROUDED	HIROSE, DF3A-4P-2DSA
14	2	SW1, SW2	CONNECTOR, SUB MINIATURE SLIDE SWITCHES	C&K., JS202011CQN
15	4	(STAND-OFF)	STAND-OFF, NYLON 0.50" tall, SNAP ON	KEYSTONE, 8833

# DEMO MANUAL DC1989B-A

## SCHEMATIC DIAGRAM

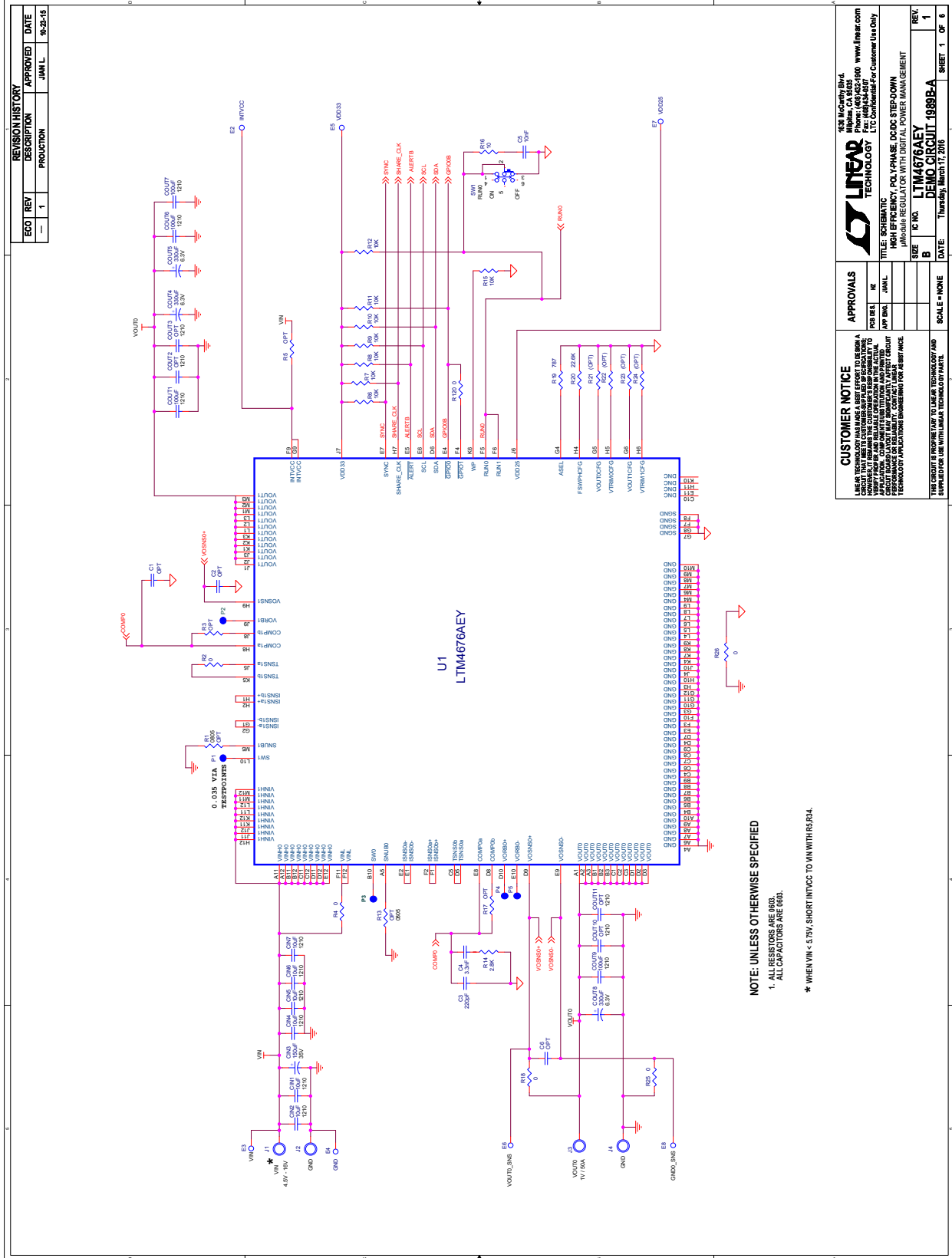

**SCHEMATIC DIAGRAM**

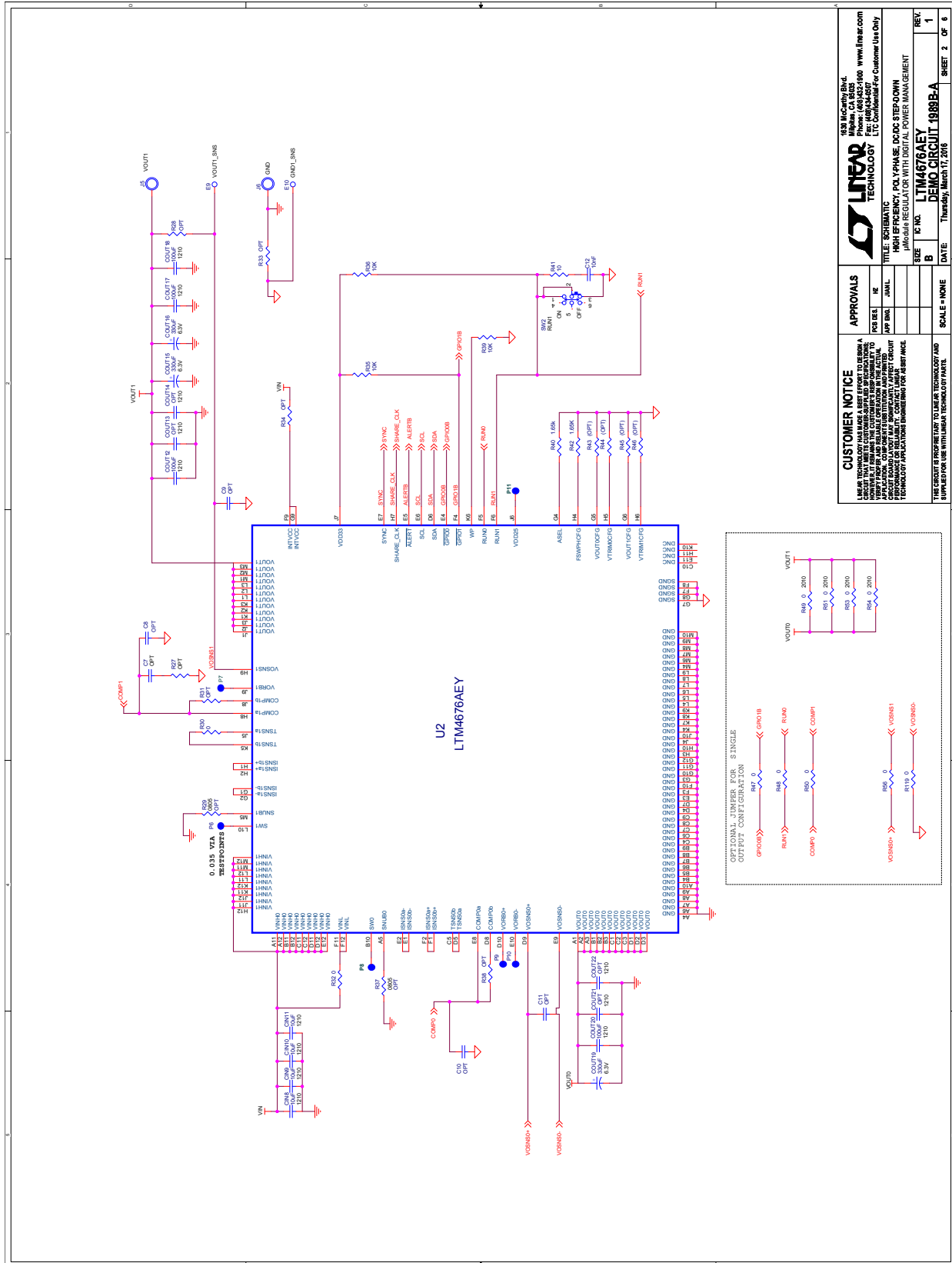

**CUSTOMER NOTICE**  
 LINEAR TECHNOLOGY MAKES A BEST EFFORT TO DESIGN A CIRCUIT THAT WILL BE OPERABLE IN THE FIELD. HOWEVER, WE DO NOT WARRANT OR REPRESENT THAT ANY CIRCUIT DESIGN OR APPLICATION WILL BE OPERABLE IN ALL APPLICATIONS. CUSTOMERS ARE RESPONSIBLE FOR THE PROPER DESIGN AND APPLICATION OF THE PRODUCT TO THEIR APPLICATIONS. LINEAR TECHNOLOGY ASSUMES NO LIABILITY FOR THE PROPER DESIGN OR APPLICATION OF THE PRODUCT TO THEIR APPLICATIONS.

**APPROVALS**

DESIGN	IN
APP. INCL.	JAIL

**SCALE** = NONE

**DATE** = Thursday, March 12, 2015

**REV.** 1

**SHEET** 2 OF 6

**IC INC.** LTM4676AEY

**DESCRIPTION** HIGH EFFICIENCY, POLY-PHASE, MODE STEP-DOWN  $\mu$ Module REGULATOR WITH DIGITAL POWER MANAGEMENT

**LINEAR TECHNOLOGY**  
 1630 McCarty Blvd.  
 Fremont, CA 94538-4000  
 www.linear.com  
 Tel: (415) 564-2000  
 Fax: (415) 564-2007  
 LTC Confidential - For Customer Use Only

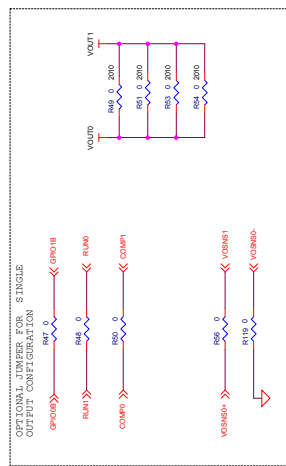

# DEMO MANUAL DC1989B-A

## SCHEMATIC DIAGRAM

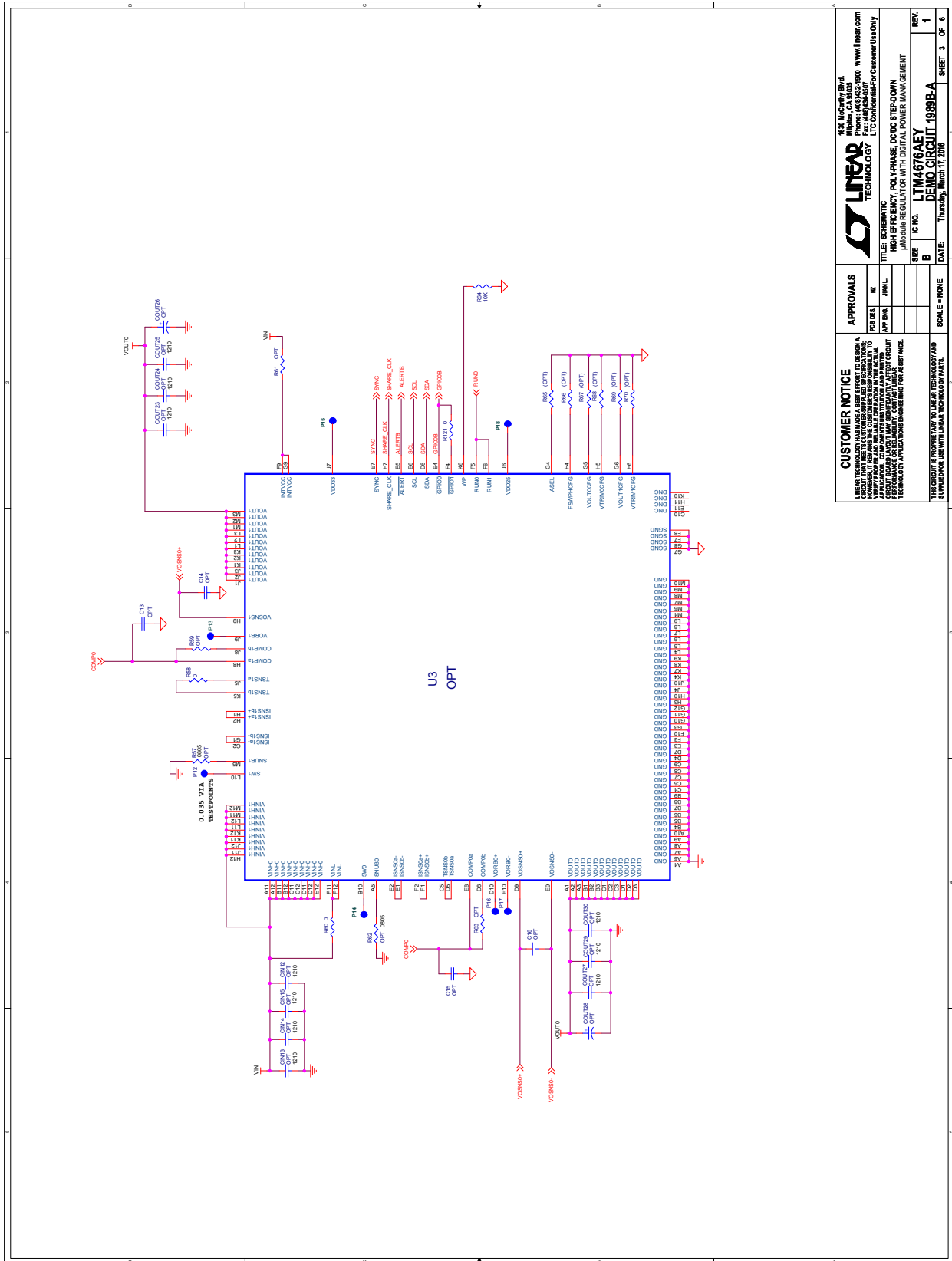

150 McCarty Blvd.  
 Linear Technology  
 Phone: (408) 451-1000 www.linear.com  
 Fax: (408) 451-1001  
 Litz Customer Care Center

**CUSTOMER NOTICE**  
 LINEAR TECHNOLOGY HAS MADE A BEST EFFORT TO DESIGN A SCHEMATIC THAT WILL BE USED AS A GUIDE TO REPRODUCE A FUNCTIONAL DEMO CIRCUIT. THE SCHEMATIC IS PROVIDED AS A GUIDE ONLY AND DOES NOT REPRESENT A COMPLETE DESIGN. THE USER IS RESPONSIBLE FOR THE DESIGN AND PERFORMANCE OF THE CIRCUIT. CONTACT LINEAR TECHNOLOGY APPLICATION ENGINEERING FOR ASSISTANCE.

**APPROVALS**

DESIGNER	JK
CHK'D BY	JANL
APP'D BY	

**SCALE** = NONE

**IC NO.** LTM4676AEY  
**TITLE** SCHEMATIC  
**DESCRIPTION** HIGH EFFICIENCY, POLYPHASE, I2C/DC STEP-DOWN  
 MICRO-REGULATOR WITH DIGITAL POWER MANAGEMENT

**REV.** 1  
**DATE** Thursday, March 17, 2016  
**SHEET** 3 OF 6







**SCHEMATIC DIAGRAM**

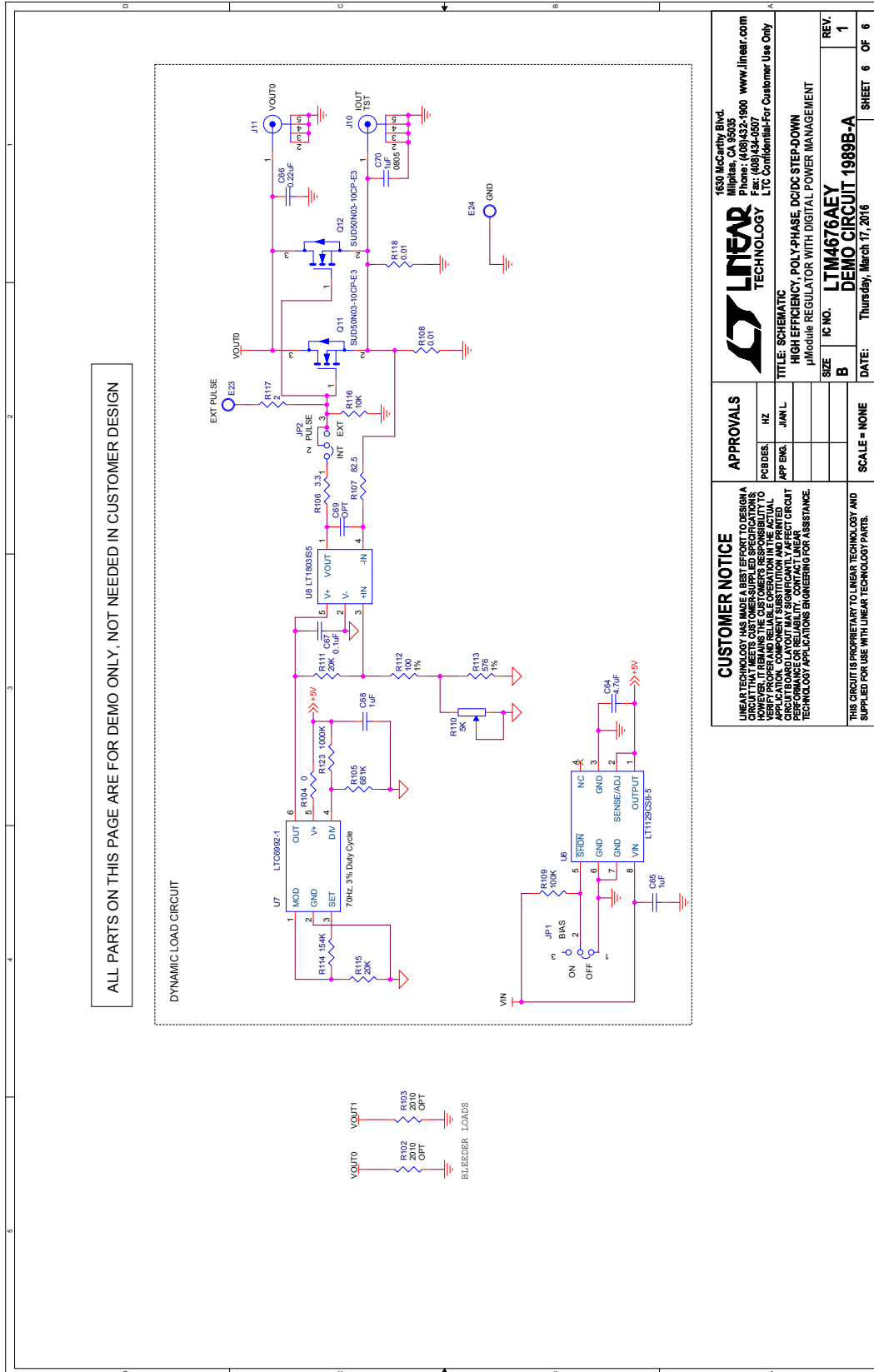

Figure 7. Circuit Schematic

# DEMO MANUAL DC1989B-A

---

## DEMONSTRATION BOARD IMPORTANT NOTICE

Linear Technology Corporation (LTC) provides the enclosed product(s) under the following **AS IS** conditions:

This demonstration board (DEMO BOARD) kit being sold or provided by Linear Technology is intended for use for **ENGINEERING DEVELOPMENT OR EVALUATION PURPOSES ONLY** and is not provided by LTC for commercial use. As such, the DEMO BOARD herein may not be complete in terms of required design-, marketing-, and/or manufacturing-related protective considerations, including but not limited to product safety measures typically found in finished commercial goods. As a prototype, this product does not fall within the scope of the European Union directive on electromagnetic compatibility and therefore may or may not meet the technical requirements of the directive, or other regulations.

If this evaluation kit does not meet the specifications recited in the DEMO BOARD manual the kit may be returned within 30 days from the date of delivery for a full refund. **THE FOREGOING WARRANTY IS THE EXCLUSIVE WARRANTY MADE BY THE SELLER TO BUYER AND IS IN LIEU OF ALL OTHER WARRANTIES, EXPRESSED, IMPLIED, OR STATUTORY, INCLUDING ANY WARRANTY OF MERCHANTABILITY OR FITNESS FOR ANY PARTICULAR PURPOSE. EXCEPT TO THE EXTENT OF THIS INDEMNITY, NEITHER PARTY SHALL BE LIABLE TO THE OTHER FOR ANY INDIRECT, SPECIAL, INCIDENTAL, OR CONSEQUENTIAL DAMAGES.**

The user assumes all responsibility and liability for proper and safe handling of the goods. Further, the user releases LTC from all claims arising from the handling or use of the goods. Due to the open construction of the product, it is the user's responsibility to take any and all appropriate precautions with regard to electrostatic discharge. Also be aware that the products herein may not be regulatory compliant or agency certified (FCC, UL, CE, etc.).

No License is granted under any patent right or other intellectual property whatsoever. **LTC assumes no liability for applications assistance, customer product design, software performance, or infringement of patents or any other intellectual property rights of any kind.**

LTC currently services a variety of customers for products around the world, and therefore this transaction **is not exclusive**.

**Please read the DEMO BOARD manual prior to handling the product.** Persons handling this product must have electronics training and observe good laboratory practice standards. **Common sense is encouraged.**

This notice contains important safety information about temperatures and voltages. For further safety concerns, please contact a LTC application engineer.

Mailing Address:

Linear Technology  
1630 McCarthy Blvd.  
Milpitas, CA 95035

Copyright © 2004, Linear Technology Corporation

## X-ON Electronics

Largest Supplier of Electrical and Electronic Components

*Click to view similar products for [Power Management IC Development Tools](#) category:*

*Click to view products by [Analog Devices](#) manufacturer:*

Other Similar products are found below :

[EVAL-ADM1168LQEBZ](#) [EVB-EP5348UI](#) [MIC23451-AAAYFL EV](#) [MIC5281YMME EV](#) [DA9063-EVAL](#) [ADP122-3.3-EVALZ](#) [ADP130-0.8-EVALZ](#) [ADP130-1.2-EVALZ](#) [ADP130-1.5-EVALZ](#) [ADP130-1.8-EVALZ](#) [ADP1714-3.3-EVALZ](#) [ADP1716-2.5-EVALZ](#) [ADP1740-1.5-EVALZ](#) [ADP1752-1.5-EVALZ](#) [ADP1828LC-EVALZ](#) [ADP1870-0.3-EVALZ](#) [ADP1871-0.6-EVALZ](#) [ADP1873-0.6-EVALZ](#) [ADP1874-0.3-EVALZ](#) [ADP1882-1.0-EVALZ](#) [ADP199CB-EVALZ](#) [ADP2102-1.25-EVALZ](#) [ADP2102-1.875EVALZ](#) [ADP2102-1.8-EVALZ](#) [ADP2102-2-EVALZ](#) [ADP2102-3-EVALZ](#) [ADP2102-4-EVALZ](#) [ADP2106-1.8-EVALZ](#) [ADP2147CB-110EVALZ](#) [AS3606-DB](#) [BQ24010EVM](#) [BQ24075TEVM](#) [BQ24155EVM](#) [BQ24157EVM-697](#) [BQ24160EVM-742](#) [BQ24296MEVM-655](#) [BQ25010EVM](#) [BQ3055EVM](#) [NCV891330PD50GEVB](#) [ISLUSBI2CKIT1Z](#) [LM2744EVAL](#) [LM2854EVAL](#) [LM3658SD-AEV/NOPB](#) [LM3658SDEV/NOPB](#) [LM3691TL-1.8EV/NOPB](#) [LM4510SDEV/NOPB](#) [LM5033SD-EVAL](#) [LP38512TS-1.8EV](#) [EVAL-ADM1186-1MBZ](#) [EVAL-ADM1186-2MBZ](#)