

15V, ±5A Monolithic Synchronous Step-Down Regulator

DESCRIPTION

Demonstration circuit 2131A is a current mode DC/DC step-down Silent Switcher® buck regulator featuring the LTC®3623. The board operates from an input range of 4V to 15V, and provides ±5A of output current. The output voltage of the demonstration board can be set from 0V to $V_{IN} - 0.5V$. It operates at 1MHz and may be synchronized to an external clock. A soft-start feature controls output voltage slew rate at start-up, reducing current surge and voltage overshoot. A power good output and current monitor signal are provided. Discontinuous conduction mode can be selected with a jumper. The demonstration board has options for cable drop compensation, negative output voltage and input voltage regulation.

This board is suitable for a wide range of battery-powered, point-of-load, DDR memory, Thermo Electric Cooler (TEC) systems and other applications. The LTC3623 is available in a low profile, 24-pin QFN package. For other output requirements, see the LTC3623 data sheet.

Design files for this circuit board are available at <http://www.linear.com/demo/DC2131A>

LT, LT, LTC, LTM, Linear Technology, the Linear logo and Silent Switcher are registered trademarks of Linear Technology Corporation. All other trademarks are the property of their respective owners.

PERFORMANCE SUMMARY Specifications are at $T_A = 25^\circ C$

SYMBOL	PARAMETER	CONDITIONS	MIN	TYP	MAX	UNITS
V_{IN}	Input Supply Range		4		15	V
V_{OUT}	Output Voltage	Jumper Selectable	1		5	V
I_{OUT}	Output Current Range, Continuous	200LFM	0		5	A
f_{SW}	Switching (Clock) Frequency			1		MHz
V_{OUT_P-P}	Output Ripple	$V_{IN} = 12V, V_{OUT} = 5V, I_{OUT} = 5A$ (20MHz BW)		<25		mV _{P-P}
I_{REG}	Output Regulation	$V_{IN}: 4V \text{ to } 15V, A_{OUT}: 0A \text{ to } 5A, V_{OUT} = 1V$		±2		%
		$V_{IN}: 4V \text{ to } 15V, A_{OUT}: 0A \text{ to } 5A, V_{OUT} = 1.5V$		±2		%
		$V_{IN}: 4V \text{ to } 15V, A_{OUT}: 0A \text{ to } 5A, V_{OUT} = 2.5V$		±2		%
		$V_{IN}: 4.7V \text{ to } 15V, A_{OUT}: 0A \text{ to } 5A, V_{OUT} = 3.3V$		±2		%
		$V_{IN}: 6.5V \text{ to } 15V, A_{OUT}: 0A \text{ to } 5A, V_{OUT} = 5V$		±2		%

QUICK START PROCEDURE

Demonstration circuit 2131A is easy to set up to evaluate the performance of the LTC3623. Refer to Figure 1 for proper measurement equipment setup and follow the procedure below:

NOTE: When measuring the output voltage ripple, care must be taken to avoid a long ground lead on the oscilloscope probe. Measure the output voltage ripple by touching the probe tip and ground ring directly across the last output capacitor as shown in Figure 1.

1. Using an input power supply that is capable of 4V to 15V, set the voltage to 12V. Then turn off the supply.
2. With power off, connect the supply to the input terminals $+V_{IN}$ and $-V_{IN}$.
 - a. If efficiency measurements are desired, an ammeter capable of measuring 5A DC or a resistor shunt can be put in series with the input supply in order to measure the DC1722A's input current.
 - b. A Voltmeter with a capability of measuring at least 15V can be placed across the input terminals in order to get an accurate input voltage measurement.
3. Turn on the power at the input.

NOTE: Make sure that the input voltage never exceeds 15V.
4. Check for the proper output voltage which is set using a jumper. Setting the jumper to the OPT position will set the output voltage to 5V.
5. Once the proper output voltage is established, connect a variable load capable of sinking 5A at 5V to the output terminals $+V_{OUT}$ and $-V_{OUT}$. Set the current for 0A.
 - a. If efficiency measurements are desired, an ammeter or a resistor shunt that is capable of handling 5A DC can be put in series with the output load in order to measure the DC3623A's output current.
 - b. A Voltmeter with a capability of measuring at least 5V can be placed across the output terminals in order to get an accurate output voltage measurement.

NOTE: If there is no output, temporarily disconnect the load to make sure that the load is not set too high.
6. Adjust the load and/or input within the operating range and observe the output voltage regulation, ripple voltage, efficiency and other desired parameters.

QUICK START PROCEDURE

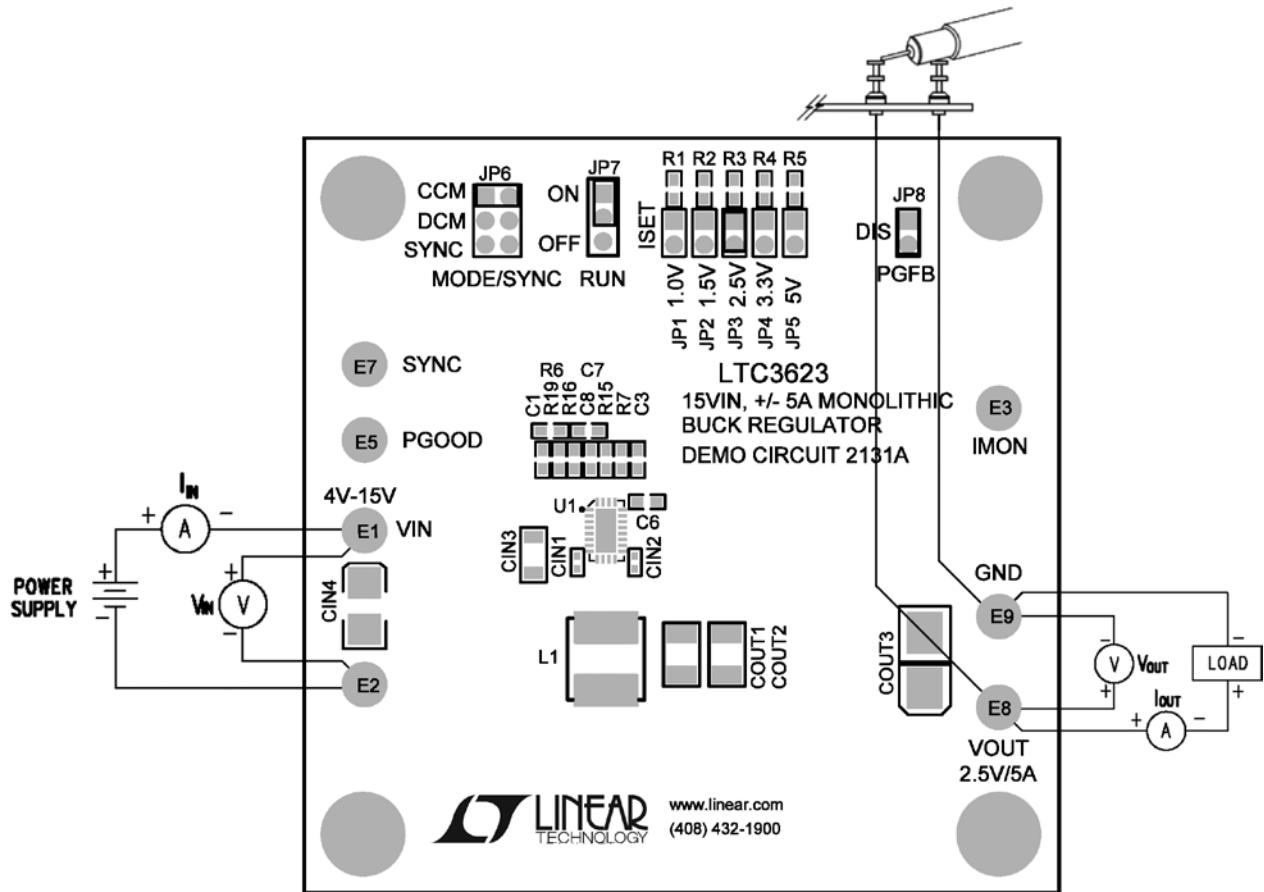

Figure 1. Proper Measurement Equipment Setup

QUICK START PROCEDURE

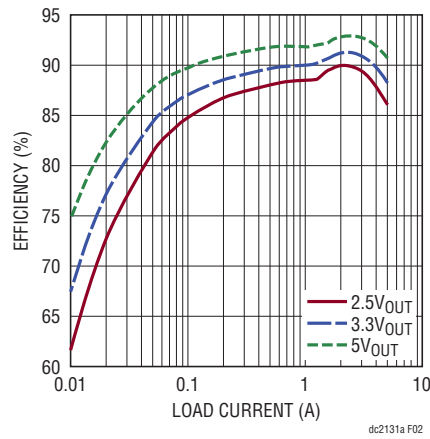

Figure 2. 12V_{IN} DCM Efficiency

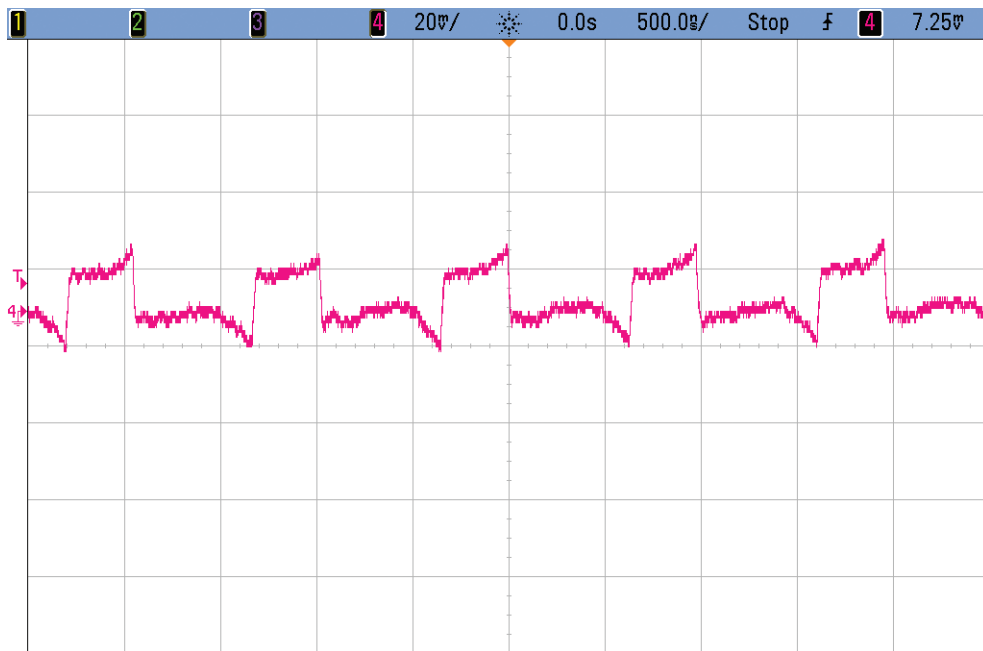

Figure 3. Output Ripple at 15V_{IN}, 5V_{OUT} and 5A_{OUT} (20mV, 500ns/DIV, 20MHz Bandwidth)

QUICK START PROCEDURE

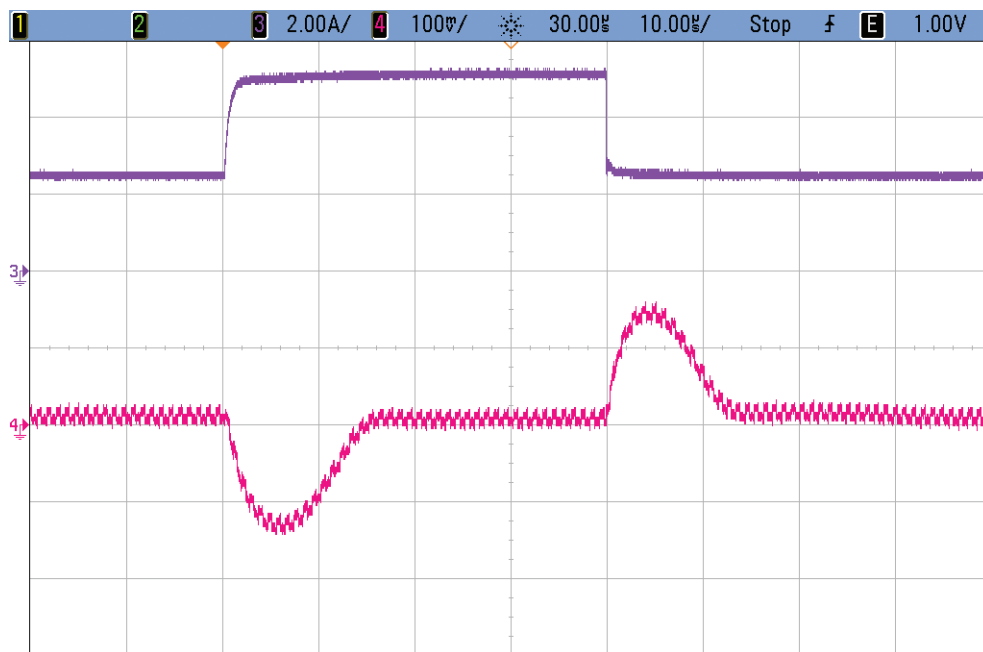

Figure 4. Transient Response Waveform at 12V_{IN}, 5V_{OUT} and 2.5 – 5 – 2.5A_{OUT} (2A, 100mV, 10µs/DIV, 20MHz Bandwidth)

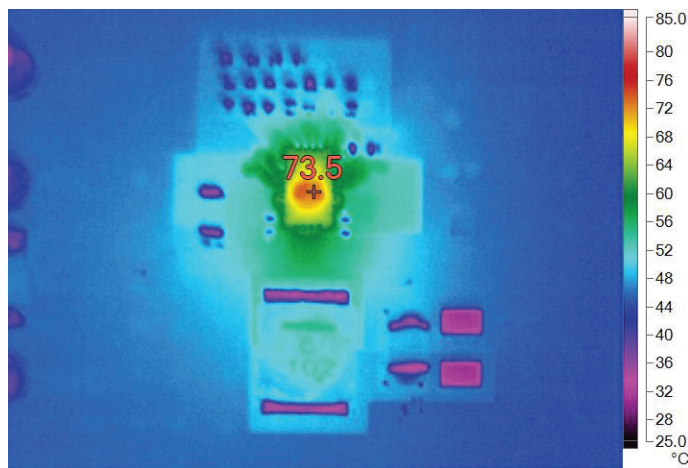

Figure 5. Thermal at 12V_{IN}, 3.3V_{OUT} and 5A_{OUT}, OLFM

DEMO MANUAL DC2131A

PARTS LIST

ITEM	QTY	REFERENCE	PART DESCRIPTION	MANUFACTURER/PART NUMBER
Required Circuit Components				
1	2	CIN1, CIN2	CAP, 2.2 μ F, X5R, 25V, 10%, 0402	MURATA., GRM155R61E225KE11
2	1	CIN3	CAP, 10 μ F, X5R, 25V, 10%, 1206	AVX., 12063D106KAT2A
3	1	CIN4	CAP, POSCAP, 22 μ F, 20V, B2 SIZE, TQC SERIES	PANASONIC, 20TQC22MYFB
4	1	COUT1	CAP, 100 μ F, X5R, 10V, 20%, 1210	MURATA, GRM32ER61A107ME20L
5	2	C1, C3	CAP, 0.01 μ F, X5R, 25V, 10%, 0603	AVX., 06033D103KAT2A
6	2	C4, C5	CAP, 0.1 μ F, X7R, 25V, 10%, 0603	AVX, 06033C104KAT2A
7	1	C6	CAP, 4.7 μ F, X5R, 10V, 0603	AVX, 0603ZD475KAT2A
8	1	C7	CAP, 1nF, COG, 25V, 1%, 0603	AVX, 06033A102FAT2A
9	1	C8	CAP, COG, 100pF, 25V, 5%, 0603	AVX, 06033A101JAT2A
10	1	L1	IND., PWR 1 μ H, 20% XAL60XX SERIES	COILCRAFT, XAL6030-102MEB
11	1	R1	RES., 24.9k, 1/10W, 1%, 0603	VISHAY, CRCW060324K0FKEA
12	1	R2	RES., 43k, 1/10W, 1%, 0603	VISHAY, CRCW060343K0FKEA
13	1	R3	RES., 100k, 1/10W, 1%, 0603	VISHAY, CRCW0603100KFKEA
14	1	R4	RES., 196k, 1/10W, 1%, 0603	VISHAY, CRCW0603200KFKEA
15	1	R7	RES., 10k, 1/10W, 1%, 0603	VISHAY, CRCW060310K0FKEA
16	1	R8	RES., 1M, 1/10W, 5%, 0603	VISHAY, CRCW06031M00JNEA
17	1	R12	RES., 1 Ω , 1/10W, 5%, 0603	VISHAY, CRCW06031R00JNEA
18	1	R15	RES., 33.2k, 1/10W, 1%, 0603	VISHAY, CRCW060333K2FKEA
19	1	R16	RES., 5.49k, 1/10W, 1%, 0603	VISHAY, CRCW06035K49FKEA
20	2	R17, R19	RES., 100k, 1/10W, 5%, 0603	VISHAY, CRCW0603100KJNEA
21	1	U1	I.C., 15V, 5A MONOLITHIC SYNCHRONOUS BUCK CONV	LINEAR TECH., LTC3623EUDD#PBF
Additional Demo Board Circuit Components				
22	0	COUT2	CAP, OPTION 1210	OPTION
23	0	COUT3, COUT4	CAP, OPTION 7343	OPTION
24	0	C9, C10, C11	CAP, OPTION 0603	OPTION
25	0	C12	CAP, OPTION 1206	OPTION
26	0	D7	DIODE, OPTION	OPTION
27	0	R5, R10, R11, R13, R14, R18, R20, R21, R24, R25	RES, OPTION 0603	OPTION
28	4	R6, R9, R22, R23	RES., 0 Ω , 1/10W, 0603	VISHAY, CRCW06030000Z0EA
Hardware: For Demo Board Only				
29	7	E1, E2, E3, E5, E7, E8, E9	TEST POINT, TURRET, 0.094" MTG. HOLE	MILL-MAX, 2501-2-00-80-00-00-07
30	6	JP1, JP2, JP3, JP4, JP5, JP8	CONN., HEADER, 1X2, 2mm	SULLINS, NRPN021PAEN-RC
31	1	JP6	CONN., HEADER, 2X3, 2mm	SULLINS, NRPN032PAEN-RC
32	1	JP7	CONN., HEADER, 1X3, 2mm	SULLINS, NRPN031PAEN-RC
33	4	XJP1, XJP3, XJP4, XJP5	SHUNT, 2mm	SAMTEC, 2SN-BK-G
34	4	(STAND-OFF)	STAND-OFF, NYLON 0.50" TALL	KEYSTONE, 8833(SNAP ON)

SCHEMATIC DIAGRAM

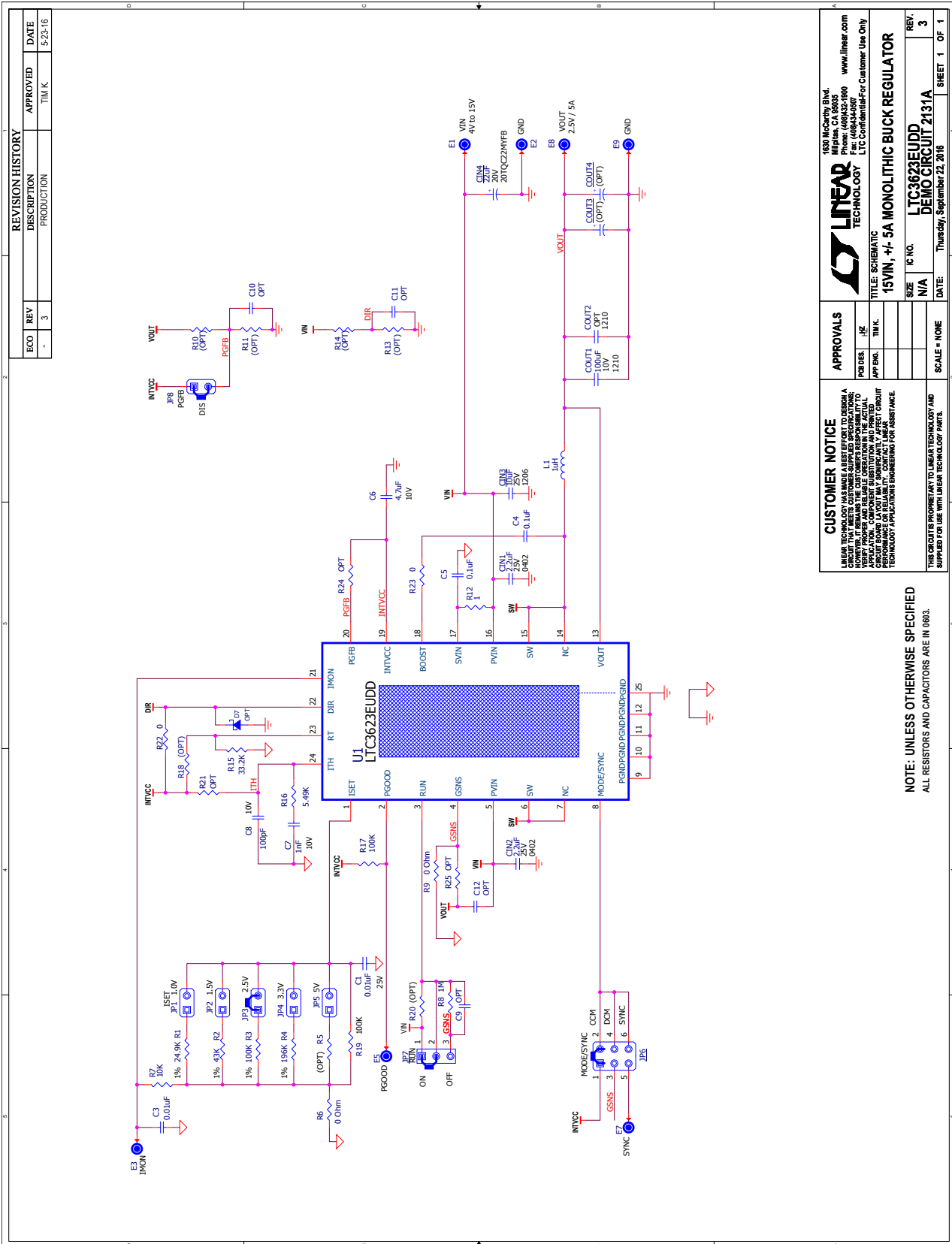

LINEAR TECHNOLOGY
 1630 McCarthy Blvd.
 Milpitas, CA 95035
 Phone: (408)452-1000
 www.linear.com
 L.T.C. Confidential - For Customer Use Only

CUSTOMER NOTICE
 LINEAR TECHNOLOGY HAS MADE A BEST EFFORT TO DESIGN A SCHEMATIC AND BOARD LAYOUT FOR THIS DEMO CIRCUIT. HOWEVER, IT REMAINS THE CUSTOMER'S RESPONSIBILITY TO VERIFY THE SCHEMATIC AND BOARD LAYOUT FOR THEIR APPLICATION. COMPONENT SUBSTITUTION AND PRINTED CIRCUIT BOARD MANUFACTURING VARIATIONS MAY AFFECT CIRCUIT PERFORMANCE OR RELIABILITY. CONTACT LINEAR TECHNOLOGY APPLICATIONS ENGINEERING FOR ASSISTANCE.

THIS CIRCUIT IS PROPRIETARY TO LINEAR TECHNOLOGY AND SUPPLIED FOR USE WITH LINEAR TECHNOLOGY PARTS.

APPROVALS	PCB DES.	APP. DES.	APP. MFG.
JK	TJK		

TITLE: SCHEMATIC
15VIN, +/-5A MONOLITHIC BUCK REGULATOR

SIZE	IC NO.	DATE
N/A	LTC3623EUDD	Thursday, September 23, 2016

DEMO CIRCUIT 2131A
 REV. 3
 SCALE = NONE
 SHEET 1 OF 1

NOTE: UNLESS OTHERWISE SPECIFIED
 ALL RESISTORS AND CAPACITORS ARE IN OHMS.

DEMO MANUAL DC2131A

DEMONSTRATION BOARD IMPORTANT NOTICE

Linear Technology Corporation (LTC) provides the enclosed product(s) under the following **AS IS** conditions:

This demonstration board (DEMO BOARD) kit being sold or provided by Linear Technology is intended for use for **ENGINEERING DEVELOPMENT OR EVALUATION PURPOSES ONLY** and is not provided by LTC for commercial use. As such, the DEMO BOARD herein may not be complete in terms of required design-, marketing-, and/or manufacturing-related protective considerations, including but not limited to product safety measures typically found in finished commercial goods. As a prototype, this product does not fall within the scope of the European Union directive on electromagnetic compatibility and therefore may or may not meet the technical requirements of the directive, or other regulations.

If this evaluation kit does not meet the specifications recited in the DEMO BOARD manual the kit may be returned within 30 days from the date of delivery for a full refund. **THE FOREGOING WARRANTY IS THE EXCLUSIVE WARRANTY MADE BY THE SELLER TO BUYER AND IS IN LIEU OF ALL OTHER WARRANTIES, EXPRESSED, IMPLIED, OR STATUTORY, INCLUDING ANY WARRANTY OF MERCHANTABILITY OR FITNESS FOR ANY PARTICULAR PURPOSE. EXCEPT TO THE EXTENT OF THIS INDEMNITY, NEITHER PARTY SHALL BE LIABLE TO THE OTHER FOR ANY INDIRECT, SPECIAL, INCIDENTAL, OR CONSEQUENTIAL DAMAGES.**

The user assumes all responsibility and liability for proper and safe handling of the goods. Further, the user releases LTC from all claims arising from the handling or use of the goods. Due to the open construction of the product, it is the user's responsibility to take any and all appropriate precautions with regard to electrostatic discharge. Also be aware that the products herein may not be regulatory compliant or agency certified (FCC, UL, CE, etc.).

No License is granted under any patent right or other intellectual property whatsoever. **LTC assumes no liability for applications assistance, customer product design, software performance, or infringement of patents or any other intellectual property rights of any kind.**

LTC currently services a variety of customers for products around the world, and therefore this transaction **is not exclusive**.

Please read the DEMO BOARD manual prior to handling the product. Persons handling this product must have electronics training and observe good laboratory practice standards. **Common sense is encouraged.**

This notice contains important safety information about temperatures and voltages. For further safety concerns, please contact a LTC application engineer.

Mailing Address:

Linear Technology
1630 McCarthy Blvd.
Milpitas, CA 95035

Copyright © 2004, Linear Technology Corporation

X-ON Electronics

Largest Supplier of Electrical and Electronic Components

Click to view similar products for [Power Management IC Development Tools](#) category:

Click to view products by [Analog Devices](#) manufacturer:

Other Similar products are found below :

[EVAL-ADM1168LQEBZ](#) [EVB-EP5348UI](#) [MIC23451-AAAYFL EV](#) [MIC5281YMME EV](#) [DA9063-EVAL](#) [ADP122-3.3-EVALZ](#) [ADP130-0.8-EVALZ](#) [ADP130-1.2-EVALZ](#) [ADP130-1.5-EVALZ](#) [ADP130-1.8-EVALZ](#) [ADP1714-3.3-EVALZ](#) [ADP1716-2.5-EVALZ](#) [ADP1740-1.5-EVALZ](#) [ADP1752-1.5-EVALZ](#) [ADP1828LC-EVALZ](#) [ADP1870-0.3-EVALZ](#) [ADP1871-0.6-EVALZ](#) [ADP1873-0.6-EVALZ](#) [ADP1874-0.3-EVALZ](#) [ADP1882-1.0-EVALZ](#) [ADP199CB-EVALZ](#) [ADP2102-1.25-EVALZ](#) [ADP2102-1.875EVALZ](#) [ADP2102-1.8-EVALZ](#) [ADP2102-2-EVALZ](#) [ADP2102-3-EVALZ](#) [ADP2102-4-EVALZ](#) [ADP2106-1.8-EVALZ](#) [ADP2147CB-110EVALZ](#) [AS3606-DB](#) [BQ24010EVM](#) [BQ24075TEVM](#) [BQ24155EVM](#) [BQ24157EVM-697](#) [BQ24160EVM-742](#) [BQ24296MEVM-655](#) [BQ25010EVM](#) [BQ3055EVM](#) [NCV891330PD50GEVB](#) [ISLUSBI2CKIT1Z](#) [LM2744EVAL](#) [LM2854EVAL](#) [LM3658SD-AEV/NOPB](#) [LM3658SDEV/NOPB](#) [LM3691TL-1.8EV/NOPB](#) [LM4510SDEV/NOPB](#) [LM5033SD-EVAL](#) [LP38512TS-1.8EV](#) [EVAL-ADM1186-1MBZ](#) [EVAL-ADM1186-2MBZ](#)