

LT4276, LT4321 PoE with Synchronous Forward and Ideal Diode Bridge

DESCRIPTION

Demonstration circuit 2262 is a PoE Powered Device (PD) with a synchronous forward isolated power supply featuring the LT[®]4276 and an ideal diode bridge controller (LT4321).

The LT4276 provides IEEE802.3af (PoE, Type 1), IEEE802.3at (PoE+, Type 2), and LTPoE++ PD interfacing and power supply control. When the PD is connected to a PSE, the LT4276 turns on an external, low-resistance, high-power N-channel Hot Swap™ FET. The LT4276 controls a high-power, small-sized power supply that utilizes a highly efficient, synchronously rectified, active clamp

forward topology. The LT4321 provides further efficiency improvement by minimizing bridge losses.

The DC2262A-A supplies a 5V output at up to 13A. It also demonstrates the use of an optional auxiliary power supply input of 48V. When present, the auxiliary supply takes priority over the PoE power path.

Design files for this circuit board are available at <http://www.linear.com/demo/DC2262A-A>

LT, LT, LTC, LTM, Linear Technology and the Linear logo are registered trademarks of Analog Devices, Inc. All other trademarks are the property of their respective owners.

PERFORMANCE SUMMARY

Specifications are at T_A = 25°C

PARAMETER	CONDITIONS	MIN	TYP	MAX	UNITS
Port Voltage (V _{PORT})	At Ethernet Port	37		57	V
Auxiliary Voltage	From AUX ⁺ to AUX ⁻ Terminals	37		57	V
Output Voltage			5		V
Output Current				13	A
Output Voltage Ripple	V _{PORT} = 57V, I _{OUT} = 13A		42		mVpp
Output Regulation			±0.1		%
Efficiency	V _{PORT} = 41V, Ethernet Port to Output		92		%
Switching Frequency			250		kHz

BOARD PHOTO

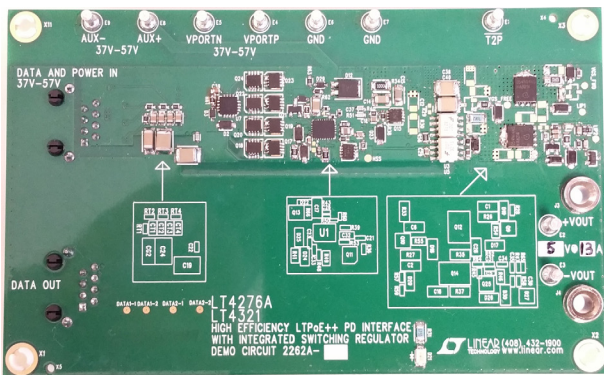

Top Side

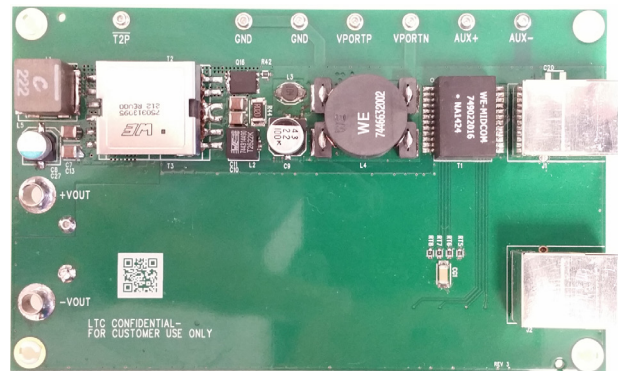

Bottom Side

TYPICAL PERFORMANCE CHARACTERISTICS

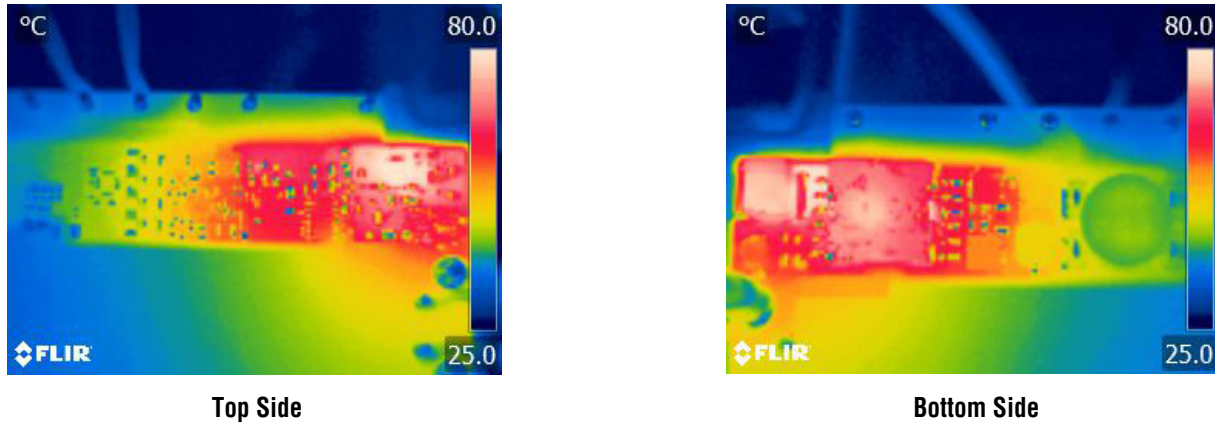

Figure 1. Thermal Pictures — $V_{PORT} = 57V$, $V_{OUT} = 5V$, $I_{OUT} = 13A$

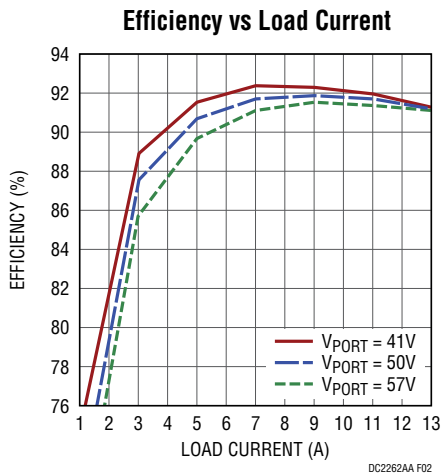

Figure 2. Efficiency (Ethernet Port to Output)

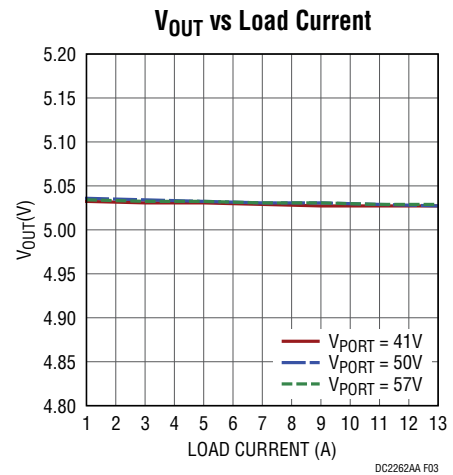

Figure 3. Output Voltage Regulation

TYPICAL PERFORMANCE CHARACTERISTICS

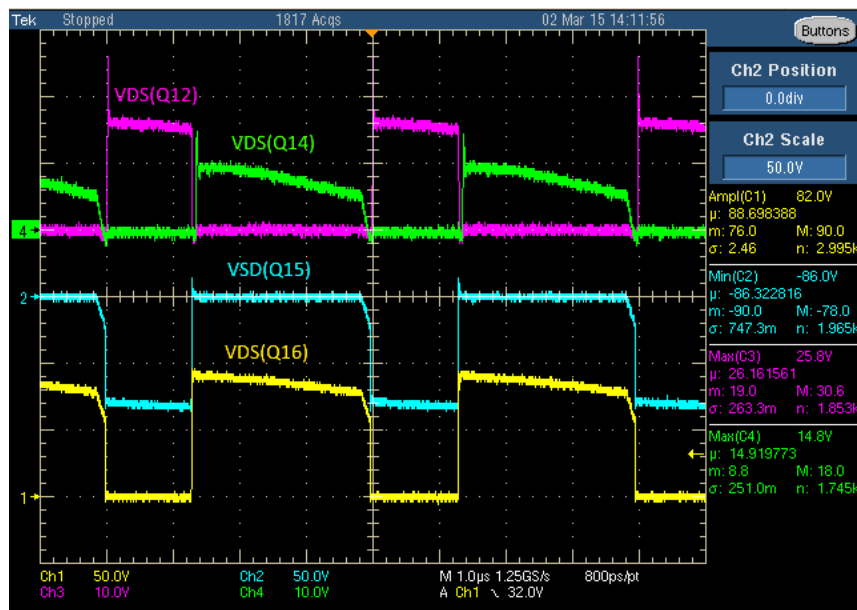

Figure 4. Stresses (V_{PORT} = 57V, 5V/13A)

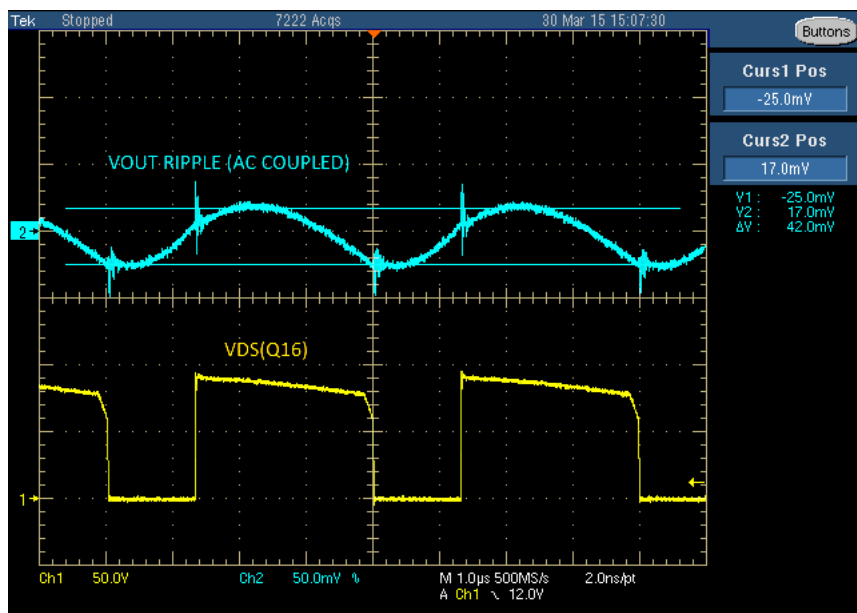

Figure 5. Output Voltage Ripple (V_{PORT} = 57V, 5V/13A)

TYPICAL PERFORMANCE CHARACTERISTICS

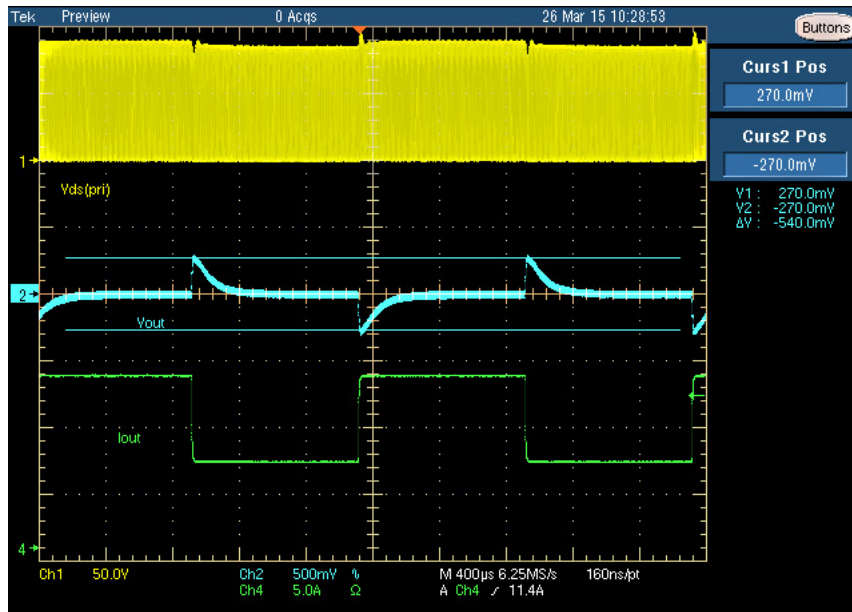

Figure 6. Load Transient Response ($V_{PORT} = 57V$, 6.5A to 13A to 6.5A)

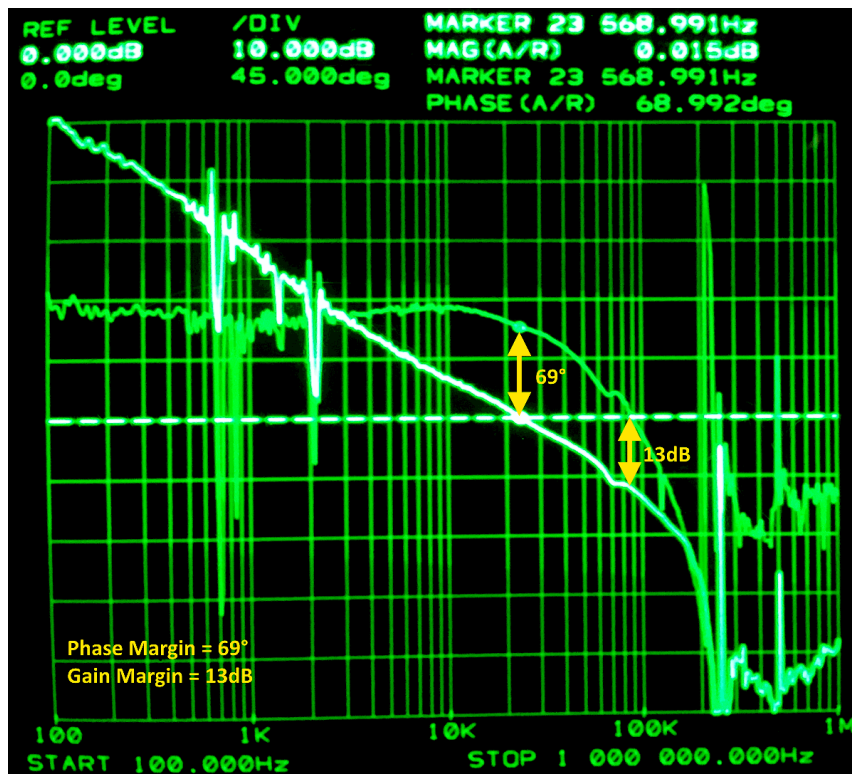

Figure 7. Gain and Phase Margin ($V_{PORT} = 57V$, 5V/13A)

QUICK START PROCEDURE

Demonstration circuit 2262A-A is easy to set up to evaluate the performance of the LT4276 in a PoE application. Refer to Figure 8 for proper equipment setup and follow the procedure below:

NOTE: When measuring the input or output voltage ripple, care must be taken to avoid a long ground lead on the oscilloscope probe. Measure the output voltage ripple by touching the probe tip and probe ground directly across the +VOUT and -VOUT terminals. See Figure 9 for proper scope probe technique.

1. Place test equipment (voltmeters, ammeters, power supplies, and electronic load) as shown in Figure 8.

2. Input supplies:

- a. Connect a LTPoE+ capable PSE with a CAT-5 cable to the RJ45 connector, J1 such as the DC1814A-D.
- b. Or, connect a 37V to 57V capable power supply (“Power Supply” in Figure 8) across VPORTP and VPORTN.
- c. If evaluating the auxiliary power supply (“Auxiliary Supply” in Figure 8), connect a 37V to 57V capable power supply across AUX+ to AUX-.

3. Check for the proper output voltage of 5V.

4. Once the proper output voltage is confirmed, adjust the load within the operating range and observe the output voltage regulation, ripple voltage, efficiency, and other parameters.

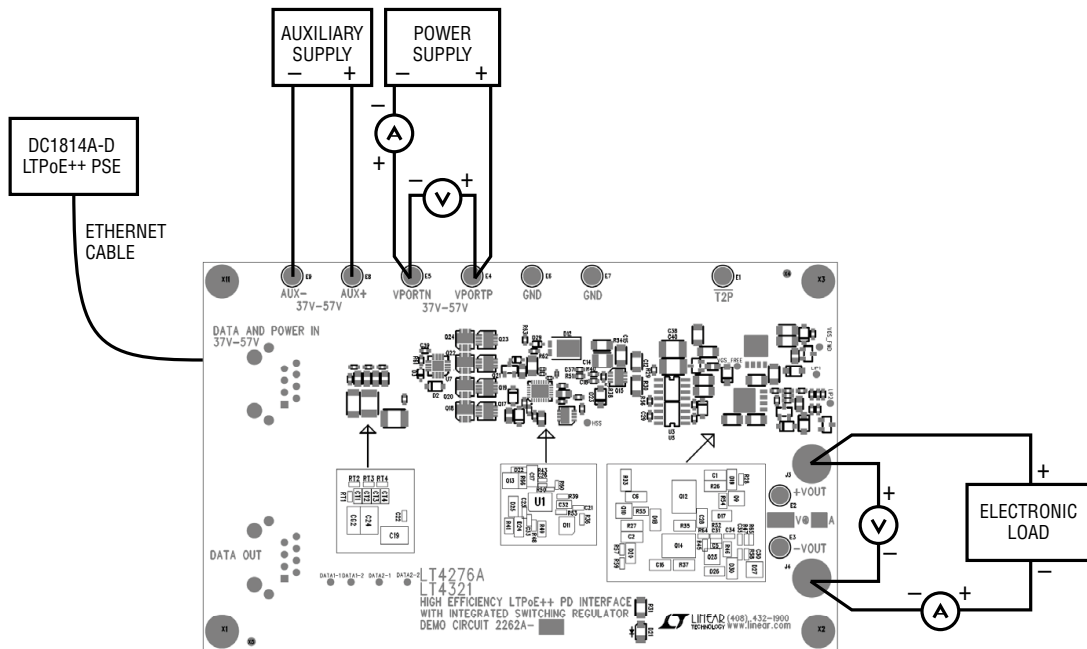

Figure 8. Proper Measurement Equipment Setup

DC2262AA F08

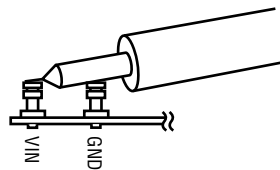

Figure 9. Measuring Input or Output Ripple

DEMO MANUAL DC2262A-A

PARTS LIST

ITEM	QTY	REFERENCE	PART DESCRIPTION	MANUFACTURER/PART NUMBER
DC2262A Required Circuit Components				
1	2	CG1, CG2	CAP, CER, X7R 1000pF 2kV 10% 1808	MURATA GR442QR73D102KW01L
2	4	CT1, CT2, CT3, CT4	CAP, CER, X7R 0.01µF 100V 20% 0805	MURATA GRM21BR72A103MA01L
3	1	C9	CAP, ELEC, 22µF 100V 20% 8 X 10.2	SUNCON 100CE22KX
4	2	C10, C11	CAP, CER, X7R 2.2µF 100V 10% 1210	MURATA GRM32ER72A225KA35
5	0	C20	CAP, CER, OPT 1206	OPT
6	1	C17	CAP, CER, X7R 10µF 16V 10% 0805	MURATA GRM31CR71A106KA01
7	4	C5, C18, C29, C31	CAP, CER, X7R 0.1µF 50V 20% 0603	MURATA GRM188R71H104MA93
8	4	C19, C24, C38, C40	CAP, CER, X7R 2.2nF 2kV 10% 1812	MURATA GR443QR73D222KW01L
9	1	C21	CAP, CER, X7R 10nF 100V 10% 0603	MURATA GRM188R72A103KA01D
10	1	C22	CAP, CER, X7R 1nF 100V 10% 0603	MURATA GRM188R72A102KA01
11	2	C23, C39	CAP, CER, X7R 0.047µF 100V 10% 0603	KEMET C0603C473K1RACTU
12	0	C26	CAP, CER, OPT 0402	OPT
13	1	C33	CAP, CER, COG 100pF 50V 10% 0603	TDK C1608C0G1H101K080AA
14	1	C37	CAP, CER, X7R 100pF 50V 10% 0603	AVX 06035C101KAT2A
15	3	D2, D24, D25	DIODE, TVS, PTVS58VS1UR 58V SOD123	NXP PTVS58VS1UR
16	1	D3	DIODE, ZENER, MMSZ5252BS 24V SOD323	DIODES INC MMSZ5252BS
17	1	D12	DIODE, SCHOTTKY, PDS5100H 100V PowerDI5	DIODES INC PDS5100H
18	1	D21	DIODE, LED, 1208, GREEN	ROHM SML-010FTT86L
19	1	D22	DIODE, SILICON, BAV19WS 120V SOD-323	DIODES INC. BAV19WS
20	1	D23	DIODE, SCHOTTKY, CMMSH1-40L 40V SOD-123F	CENTRAL SEMI. CMMSH1-40L
21	1	D27	IC, REFERENCE, ZR431F01TA SOT23	DIODES INC ZR431F01TA
22	1	D29	DIODE, SCHOTTKY, BAT54WS 30V SOD323	DIODE INC BAT54WS
23	9	E1, E2, E3, E4, E5, E6, E7, E8, E9	TP, TURRET, PAD150-094 0.094"	MILL-MAX 2501-2-00-80-00-00-07-0
24	2	J1, J2	CONN, RJ-45, SS-6488-NF-K1	STEWART CONNECTOR SS-6488-NF-K1 ALTERNATE SS-6488S-A-NF
25	2	J3, J4	CONN, BANANA, 575-4 0.175"	KEYSTONE 575-4
26	1	L3	IND, 100µH DO1608	COILCRAFT DO1608C-104
27	1	L4	IND, CMC, 2.2mH WE-LF	WÜRTH 7446632002
28	1	Q11	MOSFET, N-CH, PSMN040-100MSE 100V LFPAK33	NXP PSMN040-100MSE
29	1	Q13	TRANSISTOR, PNP, FMMT723 100V SOT23	DIODES INC. FMMT723
30	1	Q15	MOSFET, N-CH, FDMC2523P 150V POWER33	FAIRCHILD FDMC2523P
31	8	Q17, Q18, Q19, Q20, Q21, Q22, Q23, Q24	MOSFET, N-CH, PSMN075-100MSE 100 LFPAK33	NXP PSMN075-100MSE
32	8	RT1, RT2, RT3, RT4, RT5, RT6, RT7, RT8	RES, CHIP, 75Ω 5% 0603	NIC NRC06J750TRF
33	1	R28	RES, CHIP, 47k 5% 0603	NIC NRC06J473TRF
34	3	R29, R38, R57	RES, CHIP, 10k 5% 0603	NIC NRC06J103TRF
35	0	R30, R35, R37	RES, CHIP, OPT 1206	OPT
36	1	R36	RES, CHIP, 3.3k 5% 0603	NIC NRC06J332TRF
37	3	R40, R42, R65	RES, CHIP, 0Ω 5% 0603	NIC NRC06Z0TRF

PARTS LIST

ITEM	QTY	REFERENCE	PART DESCRIPTION	MANUFACTURER/PART NUMBER
38	1	R41	RES, CHIP, 8.2Ω 5% 0805	NIC NRC10J8R2TRF
39	3	R43, R50, R60	RES, CHIP, 0Ω 5% 0402	NIC NRC04ZOTRF
40	1	R51	RES, CHIP, 100k 5% 0603	NIC NRC06J104TRF
41	1	R53	RES, CHIP, 107k 1% 0603	NIC NRC06F1073TRF
42	1	R56	RES, CHIP, 750Ω 5% 0603	VISHAY CRCW0603750RJNEA
43	1	R61	Res, CHIP, 0Ω 5% 0603	NIC NRC06ZOTRF
44	1	R62	Res, CHIP, 52.3k 1% 0603	NIC NRC06F5232TRF
45	1	R63	Res, CHIP, 174k 1% 0603	NIC NRC06F1743TRF
46	1	R66	RES, CHIP, 20Ω 5% 0805	NIC NRC06F20R0TRF
47	1	T1	TRANSFORMER, ETHERNET, 749022016	WÜRTH 749022016
48	2	U3, U5	OPTO, MOC207M SOIC-8	FAIRCHILD MOC207M
49	1	U7	IC, PoE IDEAL BRIDGE CONTROLLER, LT4321IUF QFN16	LINEAR TECHNOLOGY LT4321IUF
50	4	MH1, MH2, MH3, MH4	STANDOFF, SNAP ON, 0.625"	KEYSTONE 8834

DC2262A-A Required Circuit Components

1	0	C1, C2	CAP, CER, OPT 1206	OPT
2	0	C6	CAP, CER, OPT 1206	OPT
3	0	C16	CAP, CER, OPT 1206	OPT
4	2	C7, C13	CAP, CER, X5R 100μF 6.3V 20% 1210	MURATA GRM32ER60J107ME20
5	1	C8	CAP, ELEC, 100μF 6.3V 20% 6.3 X 6.0	SUNCON 6HVA100M
6	0	C12	CAP, CER, OPT 1206	OPT
7	1	C14	CAP, CER, X7R 0.1μF 250V 10% 1210	MURATA GRM32DR72E104KW01
8	1	C15	CAP, CER, X5R 10nF 250V 1206	MURATA GRM31B7U2E103JW31
9	0	C27	CAP, ELEC, OPT 8 X 10.5	OPT
10	0	C28	CAP, CER, OPT 1206	OPT
11	1	C35	CAP, CER, X7R 33nF 50V 10% 0603	TDK C1608X7R1H333K080AA
12	1	C32	CAP, CER, X7R 0.47μF 16V 10% 0805	MURATA GRM21BR71C474KA01L
13	1	C34	CAP, CER, X7R 4.7nF 50V 10% 0603	MURATA GRM188R71H472KA01D
14	1	C30	CAP, CER, X7R 10nF 50V 10% 0603	MURATA GRM188R71H103KA01D
15	1	D26	DIODE, ZENER, CMHZ4694 8.2V SOD-123	CENTRAL SEMI. CMHZ4694
16	2	D17, D18	DIODE, SCHOTTKY, CMMSH1-40L 40V SOD-123F	CENTRAL SEMI. CMMSH1-40L
17	2	D19, D20	DIODE, ZENER, CMHZ5248B SOD-123	CENTRAL SEMI. CMHZ5248B
18	1	D30	DIODE, SCHOTTKY, CMMSH1-40L 40V SOD-123F	CENTRAL SEMI. CMMSH1-40L
19	1	L1	IND, 2.2μH XAL1010	COILCRAFT XAL1010-222ME
20	1	L2	IND, 4.9μH 744314490	WÜRTH 744 314 490
21	0	L5	IND, OPT HC1	OPT
22	0	Q9, Q10	TRANSISTOR, NPN, OPT SOT23	OPT
23	2	Q12, Q14	MOSFET, N-CH, 40V 8-PowerTDFN	INFINEON BSC054N04NSG
24	1	Q16	MOSFET, N-CH, BSC190N12NS3 120V PG-TDSON-8	INFINEON BSC190N12NS3
25	1	Q25	TRANSISTOR, NPN, MMBT3904 40V SOT23	DIODES INC. MMBT3904
26	1	R26	RES, CHIP, 10Ω 5% 1206	NIC NRC12J100TRF

DEMO MANUAL DC2262A-A

PARTS LIST

ITEM	QTY	REFERENCE	PART DESCRIPTION	MANUFACTURER/PART NUMBER
27	1	R27	RES, CHIP, 5.1 Ω 5% 1206	NIC NRC12J5R1TRF
28	1	R52	RES, CHIP, 240 Ω 5% 0603	VISHAY CRCW0603240RJNEA
29	1	R31	RES, CHIP, 620 Ω 5% 1206	NIC NRC12J621TRF
30	0	R33	RES, CHIP, OPT 1206	OPT
31	1	R34	RES, CHIP, 100 Ω 5% 1206	NIC NRC12J101TRF
32	1	R39	RES, CHIP, 13k 5% 0603	VISHAY CRCW060313K0JNEA
33	1	R44	RES, CHIP, 20m 1% 2010	VISHAY WSL2010R0200FEA
34	1	R45	Res, CHIP, 1k 5% 0603	NIC NRC06J102TRF
35	1	R46	Res, CHIP, 10 Ω 5% 0805	NIC NRC06J100TRF
36	0	R64	Res, CHIP, OPT 0603	OPT
37	1	R47	RES, CHIP, 10.0k 1% 0603	NIC NRC06F1002TRF
38	1	R48	RES, CHIP, 64.9 Ω 1% 0603	NIC NRC06F64R9TRF
39	1	R49	RES, CHIP, 80.6 Ω 1% 0805	NIC NRC06F80R6TRF
40	2	R54, R55	RES, CHIP, 0 Ω 5% 0805	NIC NRC10ZOTRF
41	1	R58	RES, CHIP, 10.0k 1% 0603	NIC NRC06F1002TRF
42	1	R59	Res, CHIP, 330 Ω 5% 0603	VISHAY CRCW0603330RJNEA
43	1	T2	TRANSFORMER, FORWARD, 750313095 EFD20	WÜRTH 750 313 095
44	0	T3	TRANSFORMER, FORWARD, OPT PLANAR	OPT
45	1	U1	IC, PD & SWITCHER CONTROLLER, LT4276 QFN28	LINEAR TECHNOLOGY LT4276AHUFD

SCHEMATIC DIAGRAM

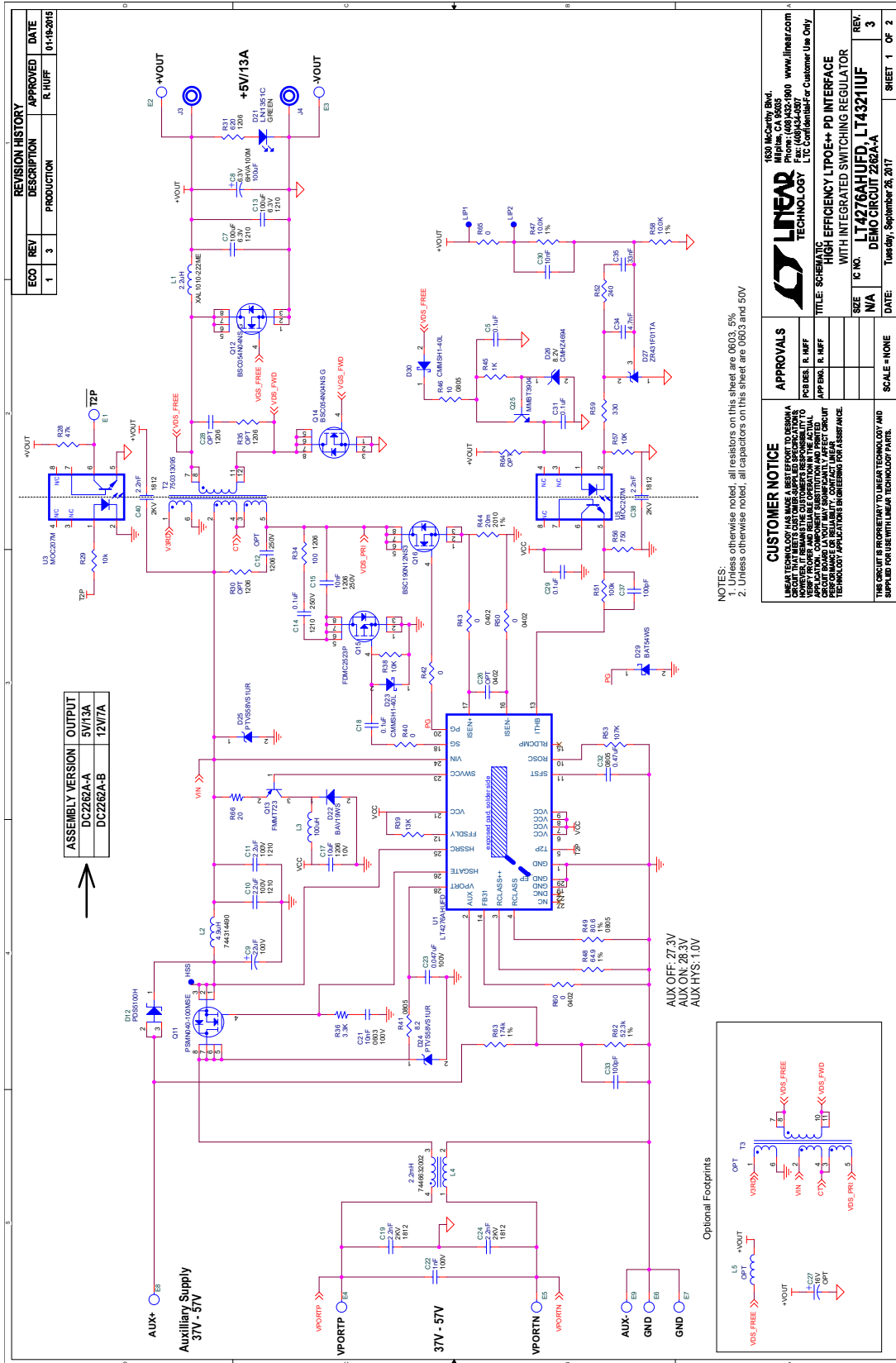

Figure 10. DC2262A-A Demo Circuit Schematic (Sheet 1)



SCHEMATIC DIAGRAM

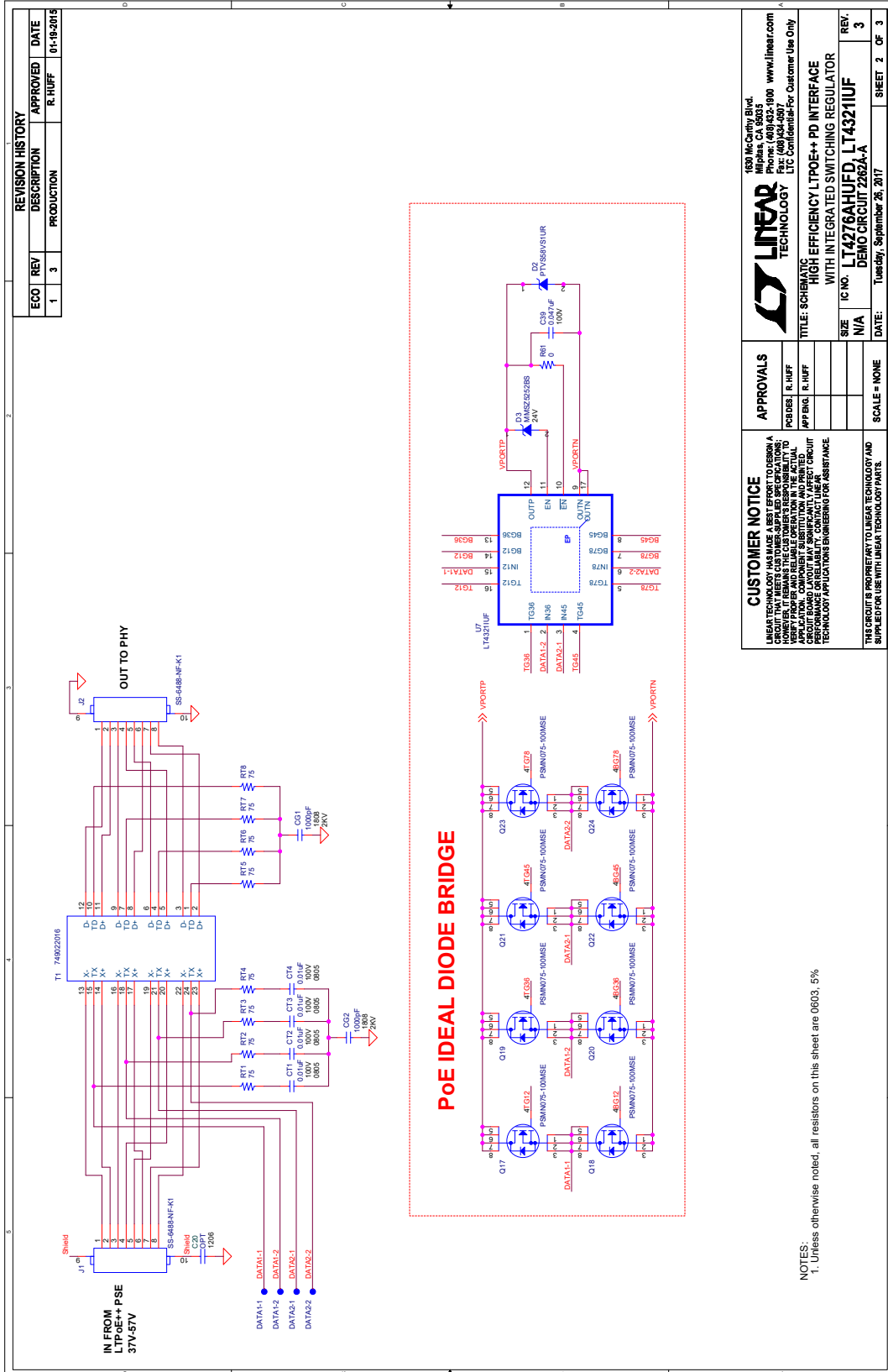
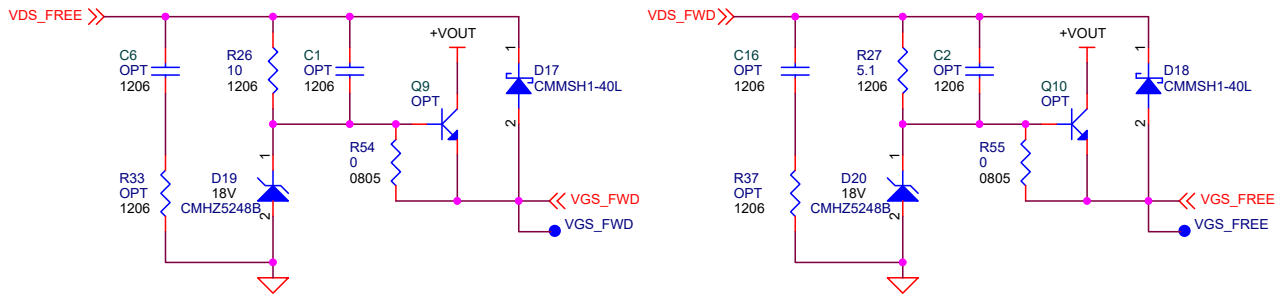

Figure 11. DC2262A-A Demo Circuit Schematic (Sheet 2)

SCHEMATIC DIAGRAM



<p>CUSTOMER NOTICE LINEAR TECHNOLOGY HAS MADE A BEST EFFORT TO DESIGN A CIRCUIT THAT MEETS CUSTOMER-SUPPLIED SPECIFICATIONS; HOWEVER, IT REMAINS THE CUSTOMER'S RESPONSIBILITY TO VERIFY PROPER AND RELIABLE OPERATION IN THE ACTUAL APPLICATION. COMPONENT SUBSTITUTION AND PRINTED CIRCUIT BOARD LAYOUT MAY SIGNIFICANTLY AFFECT CIRCUIT PERFORMANCE OR RELIABILITY. CONTACT LINEAR TECHNOLOGY APPLICATIONS ENGINEERING FOR ASSISTANCE.</p>	APPROVALS			1630 McCarthy Blvd. Milpitas, CA 95035 Phone: (408)432-1900 www.linear.com Fax: (408)434-0507 LTC Confidential-For Customer Use Only	
	PCB DES.	R. HUFF			
	APP ENG.	R. HUFF	TITLE: SCHEMATIC HIGH EFFICIENCY LTPOE++ PD INTERFACE WITH INTEGRATED SWITCHING REGULATOR		
	THIS CIRCUIT IS PROPRIETARY TO LINEAR TECHNOLOGY AND SUPPLIED FOR USE WITH LINEAR TECHNOLOGY PARTS.		SCALE = NONE	SIZE N/A	IC NO. LT4276AHUFD, LT4321IUF DEMO CIRCUIT 2262A-A
			DATE:	Tuesday, September 26, 2017	SHEET 3 OF 3

Figure 12. DC2262A-A Demo Circuit Schematic (Sheet 3)

DEMO MANUAL DC2262A-A

DEMONSTRATION BOARD IMPORTANT NOTICE

Linear Technology Corporation (LTC) provides the enclosed product(s) under the following **AS IS** conditions:

This demonstration board (DEMO BOARD) kit being sold or provided by Linear Technology is intended for use for **ENGINEERING DEVELOPMENT OR EVALUATION PURPOSES ONLY** and is not provided by LTC for commercial use. As such, the DEMO BOARD herein may not be complete in terms of required design-, marketing-, and/or manufacturing-related protective considerations, including but not limited to product safety measures typically found in finished commercial goods. As a prototype, this product does not fall within the scope of the European Union directive on electromagnetic compatibility and therefore may or may not meet the technical requirements of the directive, or other regulations.

If this evaluation kit does not meet the specifications recited in the DEMO BOARD manual the kit may be returned within 30 days from the date of delivery for a full refund. **THE FOREGOING WARRANTY IS THE EXCLUSIVE WARRANTY MADE BY THE SELLER TO BUYER AND IS IN LIEU OF ALL OTHER WARRANTIES, EXPRESSED, IMPLIED, OR STATUTORY, INCLUDING ANY WARRANTY OF MERCHANTABILITY OR FITNESS FOR ANY PARTICULAR PURPOSE. EXCEPT TO THE EXTENT OF THIS INDEMNITY, NEITHER PARTY SHALL BE LIABLE TO THE OTHER FOR ANY INDIRECT, SPECIAL, INCIDENTAL, OR CONSEQUENTIAL DAMAGES.**

The user assumes all responsibility and liability for proper and safe handling of the goods. Further, the user releases LTC from all claims arising from the handling or use of the goods. Due to the open construction of the product, it is the user's responsibility to take any and all appropriate precautions with regard to electrostatic discharge. Also be aware that the products herein may not be regulatory compliant or agency certified (FCC, UL, CE, etc.).

No License is granted under any patent right or other intellectual property whatsoever. **LTC assumes no liability for applications assistance, customer product design, software performance, or infringement of patents or any other intellectual property rights of any kind.**

LTC currently services a variety of customers for products around the world, and therefore this transaction **is not exclusive**.

Please read the DEMO BOARD manual prior to handling the product. Persons handling this product must have electronics training and observe good laboratory practice standards. **Common sense is encouraged.**

This notice contains important safety information about temperatures and voltages. For further safety concerns, please contact a LTC application engineer.

Mailing Address:

Linear Technology
1630 McCarthy Blvd.
Milpitas, CA 95035

Copyright © 2004, Linear Technology Corporation

X-ON Electronics

Largest Supplier of Electrical and Electronic Components

Click to view similar products for [Power Management IC Development Tools](#) category:

Click to view products by [Analog Devices](#) manufacturer:

Other Similar products are found below :

[EVAL-ADM1168LQEBZ](#) [EVB-EP5348UI](#) [MIC23451-AAAYFL EV](#) [MIC5281YMME EV](#) [DA9063-EVAL](#) [ADP122-3.3-EVALZ](#) [ADP130-0.8-EVALZ](#) [ADP130-1.2-EVALZ](#) [ADP130-1.5-EVALZ](#) [ADP130-1.8-EVALZ](#) [ADP1714-3.3-EVALZ](#) [ADP1716-2.5-EVALZ](#) [ADP1740-1.5-EVALZ](#) [ADP1752-1.5-EVALZ](#) [ADP1828LC-EVALZ](#) [ADP1870-0.3-EVALZ](#) [ADP1871-0.6-EVALZ](#) [ADP1873-0.6-EVALZ](#) [ADP1874-0.3-EVALZ](#) [ADP1882-1.0-EVALZ](#) [ADP199CB-EVALZ](#) [ADP2102-1.25-EVALZ](#) [ADP2102-1.875EVALZ](#) [ADP2102-1.8-EVALZ](#) [ADP2102-2-EVALZ](#) [ADP2102-3-EVALZ](#) [ADP2102-4-EVALZ](#) [ADP2106-1.8-EVALZ](#) [ADP2147CB-110EVALZ](#) [AS3606-DB](#) [BQ24010EVM](#) [BQ24075TEVM](#) [BQ24155EVM](#) [BQ24157EVM-697](#) [BQ24160EVM-742](#) [BQ24296MEVM-655](#) [BQ25010EVM](#) [BQ3055EVM](#) [NCV891330PD50GEVB](#) [ISLUSBI2CKIT1Z](#) [LM2744EVAL](#) [LM2854EVAL](#) [LM3658SD-AEV/NOPB](#) [LM3658SDEV/NOPB](#) [LM3691TL-1.8EV/NOPB](#) [LM4510SDEV/NOPB](#) [LM5033SD-EVAL](#) [LP38512TS-1.8EV](#) [EVAL-ADM1186-1MBZ](#) [EVAL-ADM1186-2MBZ](#)