

# LTC7124 17V<sub>IN</sub>, Dual 3.5A Synchronous Step-Down Regulator with Ultra-Low Quiescent Current

## DESCRIPTION

Demonstration circuit DC2329A features the [LTC<sup>®</sup>7124IUDD](#): a wide input and output voltage range, high efficiency and power density, dual 3.5A DC/DC step-down monolithic regulator. The input voltage range of the DC2329A is 3.1V to 17V. The default setting of V<sub>OUT1</sub> is user selectable from 1.2V, 1.5V and 1.8V at 3.5A max. The default setting of V<sub>OUT2</sub> is user selectable from 2.5V, 3.3V and 5.0V at 3.5A max. The default switching frequency of DC2329A is set at 1MHz typical. Programmable peak current limit of either 2.6A or 5A can be achieved by changing the setting of ILIM pin. Selectable internal or external loop compensation allows users more options to optimize the loop bandwidth and output load transient response. A user-selectable mode input is provided to allow users to trade off ripple noise for light load efficiency: pulse skipping mode (PS) or Burst Mode<sup>®</sup> (BM) of operation delivers higher efficiency at light load while forced continuous conduction mode (FCM) is preferred

for noise sensitive applications. The Mode pin can also be used to synchronize the switching frequency to an external clock. Programmable switching frequency ranges from 500kHz to 4MHz with a ±25% synchronization capture range. The constant frequency, peak current mode control architecture and integrated internal or optional external control loop compensation network, allows very fast transient response to line and load changes while maintaining loop stability.

The LTC7124 is available in a thermally enhanced, low profile 24-lead 3mm x 5mm QFN package.

It is recommended to read the data sheet and demo manual of the LTC7124 prior to using or making any changes to the DC2329A.

**Design files for this circuit board are available at <http://www.linear.com/demo/DC2329A>**

LT, LT, LTC, LTM, Linear Technology, Burst Mode and the Linear logo are registered trademarks of Analog Devices, Inc. All other trademarks are the property of their respective owners.

## PERFORMANCE SUMMARY Specifications are at T<sub>A</sub> = 25°C

SYMBOL	PARAMETER	CONDITIONS	VALUE
V <sub>IN</sub>	Input Voltage Range		3.1V to 17V
V <sub>OUT1</sub> , V <sub>OUT2</sub>	Default Output Voltages	f <sub>SW</sub> = 1MHz, V <sub>IN</sub> = 3.1V to 17V, I <sub>LOAD</sub> = 0A to 3.5A	1.8V ±2% 2.5V ±2%
	Default Switching Frequency	Programmed frequency with an external resistor from RT to GND	1MHz ±10%
I <sub>OUT1</sub> , I <sub>OUT2</sub>	Maximum Continuous Output Current I <sub>OUT</sub> per Channel	f <sub>SW</sub> = 1MHz, V <sub>IN</sub> = 3.1V to 17V (V <sub>OUT</sub> < V <sub>IN</sub> ) V <sub>OUT</sub> = 1.2V, 1.5V, 1.8V, 2.5V, 3.3V, 5V	3.5A
	Efficiency	f <sub>SW</sub> = 1MHz, V <sub>IN</sub> = 12V V <sub>OUT1</sub> = 1.8V at I <sub>OUT1</sub> = 3.5A, V <sub>OUT2</sub> = 2.5V at I <sub>OUT2</sub> = 3.5A	Channel 1: 83.7% (Figure 3) Channel 2: 87.1% (Figure 3)
	Thermal Performance (Peak Temperature)	f <sub>SW</sub> = 1MHz, V <sub>IN</sub> = 12V V <sub>OUT1</sub> = 1.8V, V <sub>OUT2</sub> = 2.5V, I <sub>OUT</sub> = 3.5A per Channel T <sub>A</sub> = 25°C, No Heat Sink, No Forced Airflow	LTC7124: 71.1°C L1: 54.8°C L2: 57°C (Figure 5)
V <sub>OUT1(P-P)</sub> V <sub>OUT2(P-P)</sub>	Dynamic Load Transient Response	f <sub>SW</sub> = 1MHz, V <sub>IN</sub> = 12V, Mode = FCM V <sub>OUT1</sub> = 1.8V, I <sub>OUT1_STEP</sub> = 1.75A to 3.5A, V <sub>OUT2</sub> = 2.5V, I <sub>OUT2_STEP</sub> = 1.75A to 3.5A C <sub>OUT</sub> = 1x100µF + 1x47µF per Channel	V <sub>OUT1(P-P)</sub> = 150mV (Figure 7a) V <sub>OUT2(P-P)</sub> = 181mV (Figure 7b)
V <sub>OUT1(P-P)</sub> V <sub>OUT2(P-P)</sub>	Output Voltage Ripples (Peak-to-Peak)	f <sub>SW</sub> = 1MHz, V <sub>IN</sub> = 12V V <sub>OUT1</sub> = 1.8V at I <sub>OUT1</sub> = 3.5A, V <sub>OUT2</sub> = 2.5V at I <sub>OUT2</sub> = 3.5A C <sub>OUT</sub> = 1x100µF + 1x47µF per Channel	V <sub>OUT1(P-P)</sub> = 6.6mV (Figure 8a) V <sub>OUT2(P-P)</sub> = 5.3mV (Figure 8b)

## QUICK START PROCEDURE

Demonstration circuit DC2329A is easy to set up to evaluate the performance of the LTC7124. Please refer to Figure 1 for proper measurement equipment setup and follow the test procedures below:

1. With power off, connect the input power supply between  $V_{IN1}$  (E1) and GND (E3).  $V_{IN1}$  and  $V_{IN2}$  are tied together (using zero ohm jumper R1) by default.
2. Connect the first load between  $V_{OUT1}$  (E11) and GND (E14) for channel 1, connect the second load between  $V_{OUT2}$  (E12) and GND (E13) for channel 2. Preset all the loads to 0A.
3. Connect the DMMs between the input test points: E1 and E3 to monitor input voltage. Connect DMMs between  $V_{OUT1}$  (E11) and GND (E14),  $V_{OUT2}$  (E12) and GND (E13) to monitor corresponding DC output voltages of Channel 1 and Channel 2.
4. Turn on the power supply at the input. Measure and make sure the input supply voltage is 12V. Place the RUN 1 (JP1) and RUN 2 (JP2) jumpers to the "ON" position. The output voltage should be 1.8V  $\pm$ 2% for channel 1 and 2.5V  $\pm$ 2% for channel 2.
5. Once the input and output voltages are properly established, adjust the input voltage between 3.1V to 17V and the load current within the operating range of 0A to 3.5A max per channel. Observe the output voltage regulation, output voltage ripples, switch node waveform, load transient response and other parameters. Refer to Figure 2 for proper output voltage ripple measurement.

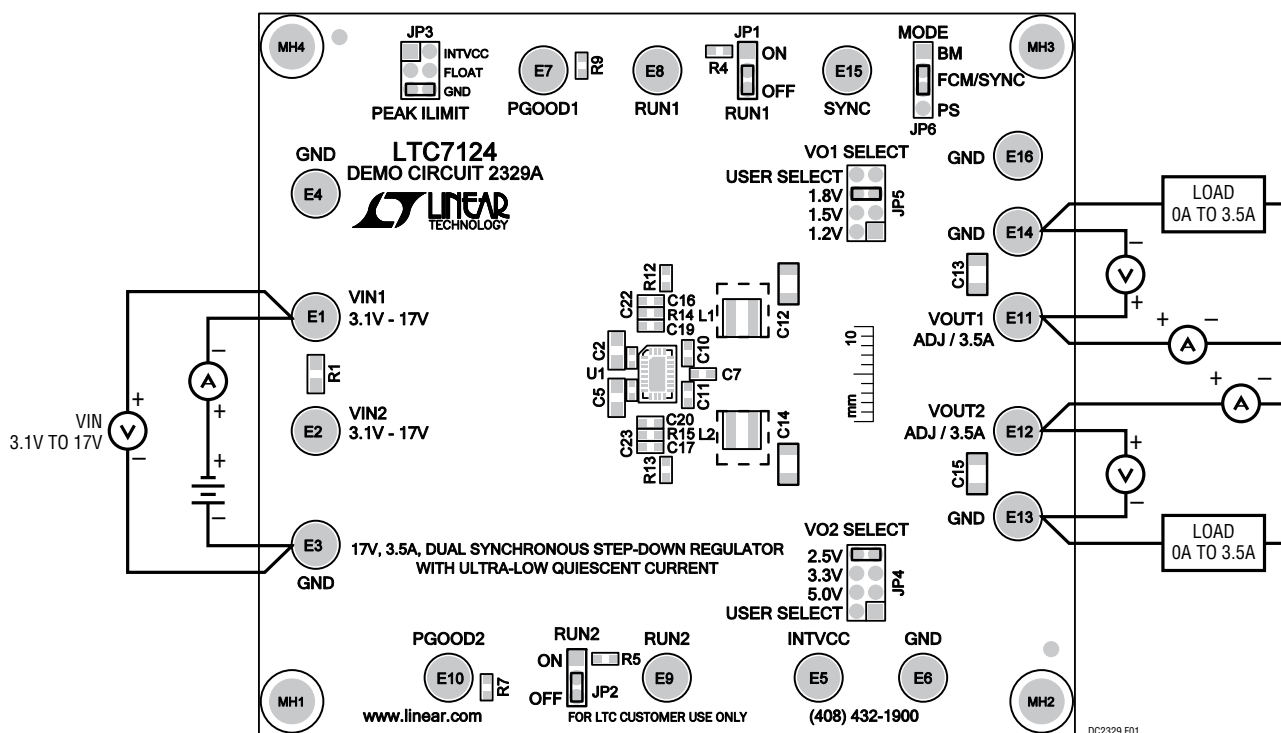

Figure 1. Proper Measurement Equipment Setup

## QUICK START PROCEDURE

Note 1: To measure the input/output voltage ripples properly, do not use the long ground lead on the oscilloscope probe. See Figure 2 for the proper scope probe technique. Short, still leads need to be soldered to the (+) and (-) terminals of an input or output capacitor. The probe's ground ring needs to touch the (-) lead and the probe tip needs to touch the (+) lead.

6. To program other output voltages for channel 1 or channel 2, put the RUN1 (JP1) and RUN2 (JP2) jumpers to the "OFF" positions, move JP5 and JP4 to the desired output voltage marking of VO1 SELECT, VO2 SELECT and repeat step 1 to step 5.
7. **(Option) Programmable Peak Current Limit.**

The default onboard current limit setting is 5A peak current limit for both channels. DC2329A provides an option to program the peak current limit as the following:

ILIM SETTINGS (USE JP3)	TYPICAL PEAK CURRENT LIMIT
GND	5A (Both Channels)
INTV <sub>CC</sub>	2.6A (Both Channels)
FLOAT	5A (Channel 1) 2.6A (Channel 2)

Notes: Selecting another ILIM setting that is different from the default demo board ILIM setting results in different control loop bandwidth and load transient performance. Therefore, it is recommended to optimize the loop accordingly when consider changing the ILIM pin setting to obtain the best load transient response and loop stability.

8. **(Option) Selectable Internal Or External Control Loop Compensation Network**

DC2329A uses onboard external type II compensation network that has been optimized for the default input and output voltage ranges at no load to maximum load current at 1MHz switching frequency. The internal control loop compensation network can be activated by removing all external compensation components at ITH1 and ITH2 (C16, C19, R14; C17, C20, R15), then shorting ITH1 and ITH2 to INTV<sub>CC</sub> (stuff R12 and R13 with zero ohm resistors). Users can adjust the output capacitors and feedforward capacitors (C18, C21) of channel 1 and channel 2 to obtain the desired loop bandwidth if internal compensation is being used.

9. **(Option) Programmable Switching Frequency**

The default switching frequency of DC2329A is set at 1MHz typical. Switching frequency is programmed by a single resistor from RT pin to GND. It is recommended to select R3 between 226kΩ to 20.5kΩ to set the switching frequency from 500kHz to 4MHz respectively.

10. **(Option) External Frequency Synchronization**

The MODE/PLLIN pin can be used to synchronize the internal oscillator clock frequency to the external clock signal. Place JP6 (MODE) at FCM/SYNC position and make sure R26 and R27 are not stuffed. Apply an external clock signal at SYNC test point (E15) to vary the switching frequency within ±25% of the preset frequency.

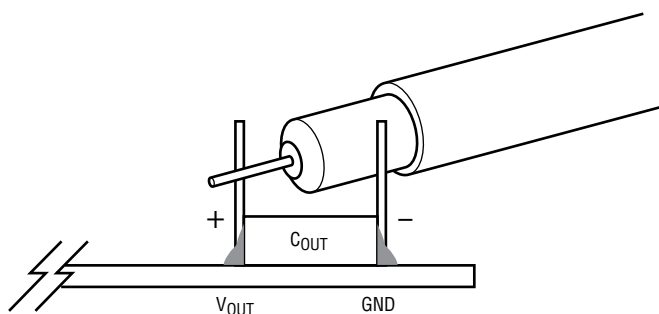

Figure 2. Scope Probe Placement for Measuring Input or Output Voltage Ripples

## QUICK START PROCEDURE

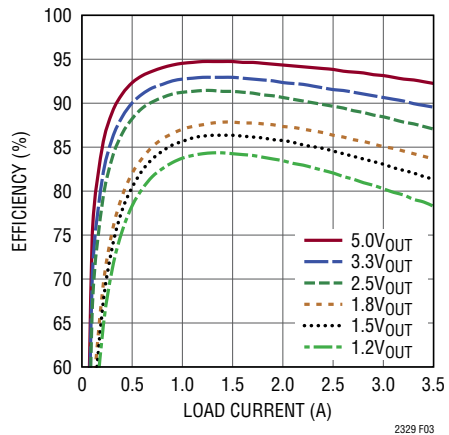

Figure 3. Measured Efficiency at 12V<sub>IN</sub>, 1MHz, FCM

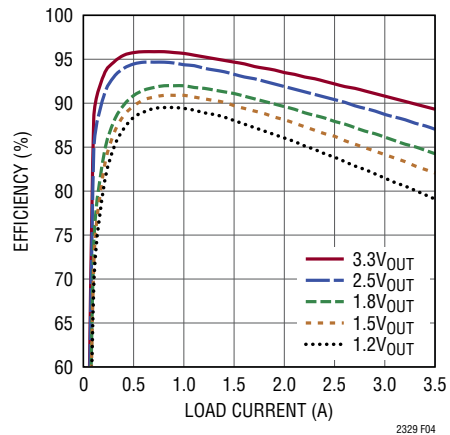
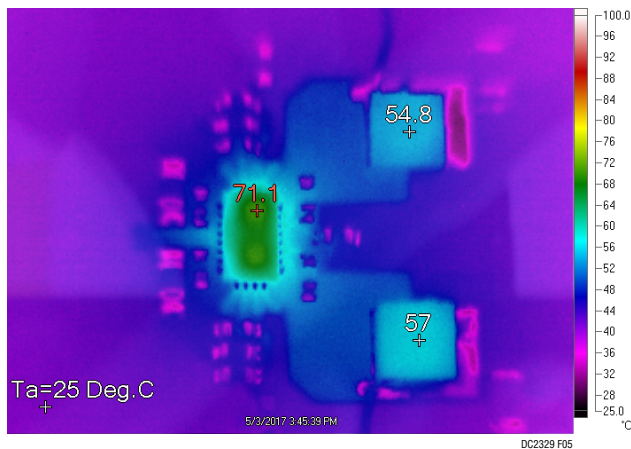
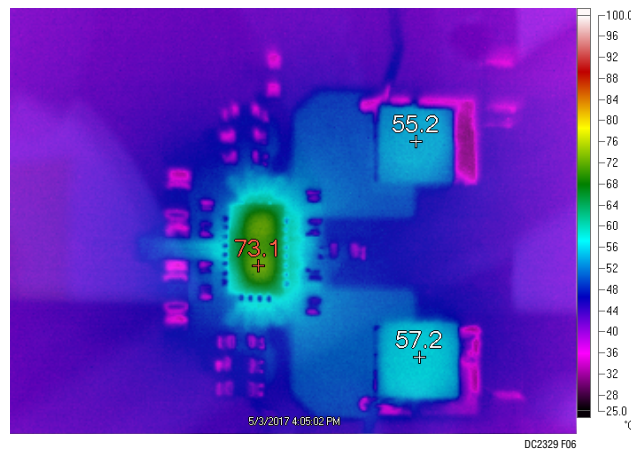

Figure 4. Measured Efficiency at 5V<sub>IN</sub>, 1MHz, FCM



f<sub>SW</sub> = 1MHz TYPICAL  
 V<sub>OUT1</sub> = 1.8V AT 3.5A  
 V<sub>OUT2</sub> = 2.5V AT 3.5A  
 T<sub>A</sub> = 25°C  
 NO HEAT SINK, NO FORCED AIRFLOW

Figure 5. Thermal Performance at 12V<sub>IN</sub>



f<sub>SW</sub> = 1MHz TYPICAL  
 V<sub>OUT1</sub> = 1.8V AT 3.5A  
 V<sub>OUT2</sub> = 2.5V AT 3.5A  
 T<sub>A</sub> = 25°C  
 NO HEAT SINK, NO FORCED AIRFLOW

Figure 6. Thermal Performance at 5V<sub>IN</sub>

## QUICK START PROCEDURE

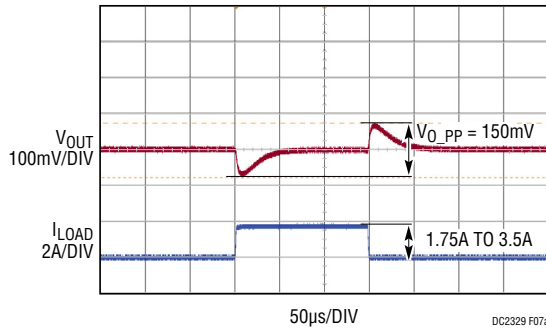

$f_{SW} = 1\text{MHz}$   
 $V_{IN} = 12\text{V}, V_{OUT1} = 1.8\text{V}$   
 $L = 1.5\mu\text{H}$   
 $I_{LOAD\ STEP} = 1.75\text{A TO } 3.5\text{A AT } 1.75\text{A}/\mu\text{s}$   
 $C_{OUT\_CERAMIC} = 1 \times 100\mu\text{F}, 6.3\text{V}, \text{X5R}, 1206$   
 $+ 1 \times 47\mu\text{F}, 10\text{V}, \text{X5R}, 1206$   
**EXTERNAL COMPENSATION:**  
 $C_{THP} = 15\text{pF}, C_{TH} = 1000\text{pF}, R_{TH} = 14\text{k}, C_{FF} = 22\text{pF}$

**Figure 7a. Load Transient Response (CH1)**

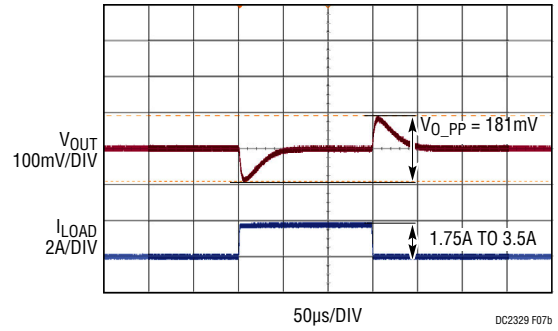

$f_{SW} = 1\text{MHz}$   
 $V_{IN} = 12\text{V}, V_{OUT2} = 2.5\text{V}$   
 $L = 3.3\mu\text{H}$   
 $I_{LOAD\ STEP} = 1.75\text{A TO } 3.5\text{A AT } 1.75\text{A}/\mu\text{s}$   
 $C_{OUT\_CERAMIC} = 1 \times 100\mu\text{F}, 6.3\text{V}, \text{X5R}, 1206$   
 $+ 1 \times 47\mu\text{F}, 10\text{V}, \text{X5R}, 1206$   
**EXTERNAL COMPENSATION:**  
 $C_{THP} = 10\text{pF}, C_{TH} = 820\text{pF}, R_{TH} = 12.4\text{k}, C_{FF} = 22\text{pF}$

**Figure 7b. Load Transient Response (CH2)**

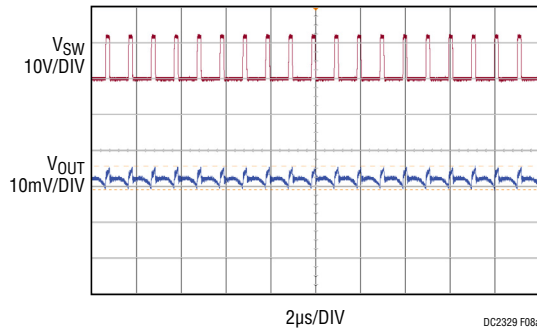

$f_{SW} = 1\text{MHz}$   
 $V_{IN} = 12\text{V}, V_{OUT1} = 1.8\text{V}$   
 $I_{LOAD1} = 3.5\text{A}$

**Figure 8a. Measured Output Ripple Voltage (CH1)**

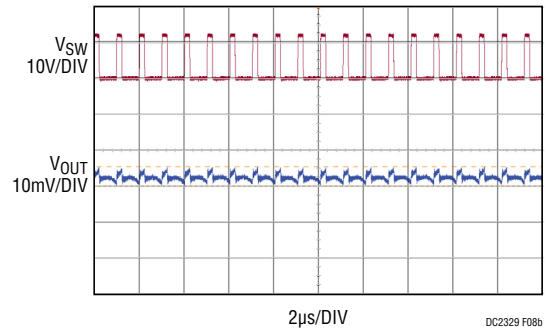

$f_{SW} = 1\text{MHz}$   
 $V_{IN} = 12\text{V}, V_{OUT2} = 2.5\text{V}$   
 $I_{LOAD2} = 3.5\text{A}$

**Figure 8b. Measured Output Ripple Voltage (CH2)**

## PARTS LIST

ITEM	QTY	REFERENCE	PART DESCRIPTION	MANUFACTURER/PART NUMBER
<b>Required Circuit Components</b>				
1	2	CIN1, CIN2	CAP, 47µF 20% 25V 50m Ohm	AVX TCJE476M025R0050
2	2	C1, C6	CAP, 1206 22µF 10% 25V X5R	AVX 12063D226KAT2A
3	2	C2, C5	CAP, 0805 10µF 10% 25V, X5R	MURATA GRM219R61E106KA12D
4	1	C7	CAP, 0603 4.7µF 10% 10V X5R	AVX 0603ZD475KAT2A
5	2	C10, C11	CAP, 0603 0.1µF 10% 50V X7R	TDK C1608X7R1H104K

# DEMO MANUAL DC2329A

## PARTS LIST

ITEM	QTY	REFERENCE	PART DESCRIPTION	MANUFACTURER/PART NUMBER
6	2	C12, C14	CAP, 1206 100µF 20% 6.3V X5R	MURATA GRM31CR60J107ME39L
7	2	C13, C15	CAP, 1206 47µF 10% 10V X5R	MURATA GRM31CR61A476KE15
8	1	C16	CAP, 0603 1nF 5% 50V X7R	AVX 06035C102JAT2A
9	1	C17	CAP, 0603 820pF 5% 50V C0G	AVX 06035A821JAT2A
10	2	C18, C21	CAP, 0603 22pF 5% 50V C0G	MURATA GRM1885C1H220JA01D
11	1	C19	CAP, 0603 15pF 5% 50V C0G	AVX 06035A150JAT2A
12	1	C20	CAP, 0603 10pF 5% 50V C0G	AVX 06035A100JAT2A
13	1	C22, C23	CAP, 0402 2.2µF 10% 25V X5R	MURATA GRM155R61E225KE11D
14	1	L1	IND, 1.5µH	COILCRAFT XAL4020-152ME
15	1	L2	IND, 3.3µH	COILCRAFT XAL4030-332ME
16	3	R1	RES, 0805 0Ω JUMPER	VISHAY CRCW08050000Z0EA
17	2	R3, R7, R9	RES, 0603 100k 1% 0.1W	VISHAY CRCW0603100KFKEA
18	2	R4, R5, R10, R11	RES, 0603 0Ω JUMPER	VISHAY CRCW06030000Z0EA
19	1	R14	RES, 0603 14k 1% 0.1W	VISHAY CRCW060314K0FKEA
20	1	R15	RES, 0603 12.4k 1% 0.1W	VISHAY CRCW060312K4FKEA
21	3	R16, R17, R21	RES, 0603 619k 1% 1/10W	VISHAY CRCW0603619KFKEA
22	1	R19	RES, 0603 309k 1% 1/10W	VISHAY CRCW0603309KFKEA
23	1	R20	RES, 0603 412k 1% 1/10W	VISHAY CRCW0603412KFKEA
24	1	R22	RES, 0603 196k 1% 1/10W	VISHAY CRCW0603196KFKEA
25	1	R23	RES, 0603 137k 1% 1/10W	VISHAY CRCW0603137KFKEA
26	1	R24	RES, 0603 84.5k 1% 1/10W	VISHAY CRCW060384K5FKEA
27	2	R26, R27	RES, 0603 1MΩ 1% 1/10W	VISHAY CRCW06031M00FKEA
28	1	U1	IC, DUAL DC/DC SYNCHRONOUS STEP-DOWN REGULATOR	LINEAR TECH LTC7124IUDD

### Additional Demo Board Circuit Components

1	0	C3, C4	CAP, 100µF 20% 25V ELEC OPTION	PANASONIC 25SVPF100M OPTION
2	0	C8, C9, C24	CAP, 0603 OPTION	OPTION
3	0	C25, C26	CAP, 1206 OPTION	OPTION
4	0	R6, R8, R18, R25	RES, 0603 OPTION	OPTION
5	0	R12, R13	RES, 0603 0Ω JUMPER OPTION	VISHAY CRCW06030000Z0EA OPTION

### Hardware: For Demo Board Only

1	16	E1, E2, E3, E4, E5, E6, E7, E8, E9, E10, E11, E12, E13, E14, E15, E16	TURRET	MILL-MAX 2501-2-00-80-00-00-07-0
2	2	JP1, JP2	HEADER, 3PIN, 2mm	SAMTEC TMM-103-02-L-S
3	1	JP3	HEADER, 3PIN, DBL ROW 2mm	SULLINS NRPN032PAEN-RC
4	2	JP4, JP5	HEADER, 4PIN, DBL ROW 2mm	SAMTEC TMM-104-02-L-D
5	1	JP6	HEADER, 4PIN, 2mm	SAMTEC TMM-104-02-L-S
6	4	MH1, MH2, MH3, MH4	STANDOFF, SNAP ON	KEYSTONE_8834
7	6	XJP1, XJP2, XJP3, XJP4, XJP5, XJP6	SHUNT, 2mm	SAMTEC 2SN-BK-G

SCHEMATIC DIAGRAM

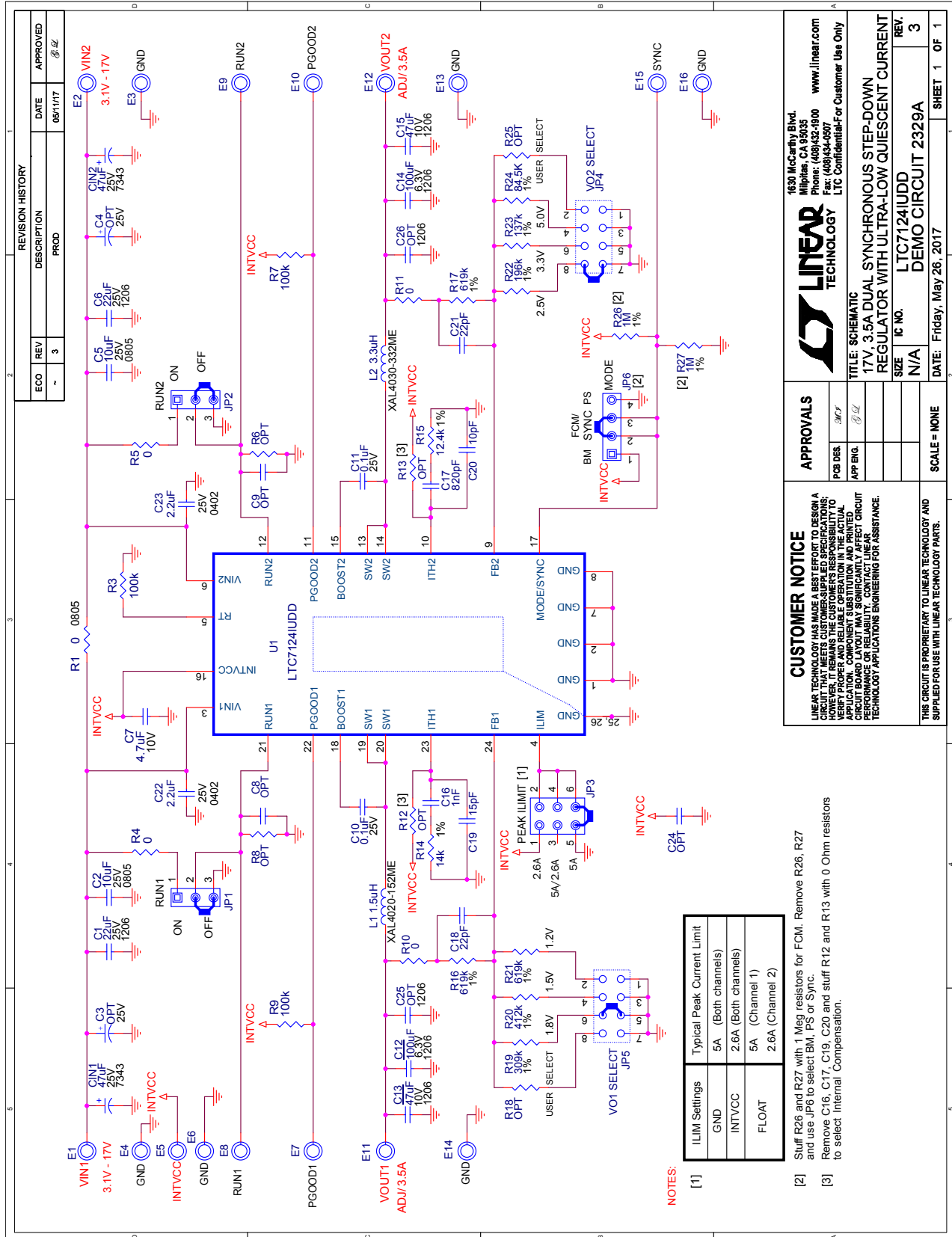



# DEMO MANUAL DC2329A

---

## DEMONSTRATION BOARD IMPORTANT NOTICE

Linear Technology Corporation (LTC) provides the enclosed product(s) under the following **AS IS** conditions:

This demonstration board (DEMO BOARD) kit being sold or provided by Linear Technology is intended for use for **ENGINEERING DEVELOPMENT OR EVALUATION PURPOSES ONLY** and is not provided by LTC for commercial use. As such, the DEMO BOARD herein may not be complete in terms of required design-, marketing-, and/or manufacturing-related protective considerations, including but not limited to product safety measures typically found in finished commercial goods. As a prototype, this product does not fall within the scope of the European Union directive on electromagnetic compatibility and therefore may or may not meet the technical requirements of the directive, or other regulations.

If this evaluation kit does not meet the specifications recited in the DEMO BOARD manual the kit may be returned within 30 days from the date of delivery for a full refund. **THE FOREGOING WARRANTY IS THE EXCLUSIVE WARRANTY MADE BY THE SELLER TO BUYER AND IS IN LIEU OF ALL OTHER WARRANTIES, EXPRESSED, IMPLIED, OR STATUTORY, INCLUDING ANY WARRANTY OF MERCHANTABILITY OR FITNESS FOR ANY PARTICULAR PURPOSE. EXCEPT TO THE EXTENT OF THIS INDEMNITY, NEITHER PARTY SHALL BE LIABLE TO THE OTHER FOR ANY INDIRECT, SPECIAL, INCIDENTAL, OR CONSEQUENTIAL DAMAGES.**

The user assumes all responsibility and liability for proper and safe handling of the goods. Further, the user releases LTC from all claims arising from the handling or use of the goods. Due to the open construction of the product, it is the user's responsibility to take any and all appropriate precautions with regard to electrostatic discharge. Also be aware that the products herein may not be regulatory compliant or agency certified (FCC, UL, CE, etc.).

No License is granted under any patent right or other intellectual property whatsoever. **LTC assumes no liability for applications assistance, customer product design, software performance, or infringement of patents or any other intellectual property rights of any kind.**

LTC currently services a variety of customers for products around the world, and therefore this transaction **is not exclusive**.

**Please read the DEMO BOARD manual prior to handling the product.** Persons handling this product must have electronics training and observe good laboratory practice standards. **Common sense is encouraged.**

This notice contains important safety information about temperatures and voltages. For further safety concerns, please contact a LTC application engineer.

Mailing Address:

Linear Technology  
1630 McCarthy Blvd.  
Milpitas, CA 95035

Copyright © 2004, Linear Technology Corporation



## X-ON Electronics

Largest Supplier of Electrical and Electronic Components

*Click to view similar products for [Power Management IC Development Tools](#) category:*

*Click to view products by [Analog Devices](#) manufacturer:*

Other Similar products are found below :

[EVAL-ADM1168LQEBZ](#) [EVB-EP5348UI](#) [MIC23451-AAAYFL EV](#) [MIC5281YMME EV](#) [DA9063-EVAL](#) [ADP122-3.3-EVALZ](#) [ADP130-0.8-EVALZ](#) [ADP130-1.2-EVALZ](#) [ADP130-1.5-EVALZ](#) [ADP130-1.8-EVALZ](#) [ADP1714-3.3-EVALZ](#) [ADP1716-2.5-EVALZ](#) [ADP1740-1.5-EVALZ](#) [ADP1752-1.5-EVALZ](#) [ADP1828LC-EVALZ](#) [ADP1870-0.3-EVALZ](#) [ADP1871-0.6-EVALZ](#) [ADP1873-0.6-EVALZ](#) [ADP1874-0.3-EVALZ](#) [ADP1882-1.0-EVALZ](#) [ADP199CB-EVALZ](#) [ADP2102-1.25-EVALZ](#) [ADP2102-1.875EVALZ](#) [ADP2102-1.8-EVALZ](#) [ADP2102-2-EVALZ](#) [ADP2102-3-EVALZ](#) [ADP2102-4-EVALZ](#) [ADP2106-1.8-EVALZ](#) [ADP2147CB-110EVALZ](#) [AS3606-DB](#) [BQ24010EVM](#) [BQ24075TEVM](#) [BQ24155EVM](#) [BQ24157EVM-697](#) [BQ24160EVM-742](#) [BQ24296MEVM-655](#) [BQ25010EVM](#) [BQ3055EVM](#) [NCV891330PD50GEVB](#) [ISLUSBI2CKIT1Z](#) [LM2744EVAL](#) [LM2854EVAL](#) [LM3658SD-AEV/NOPB](#) [LM3658SDEV/NOPB](#) [LM3691TL-1.8EV/NOPB](#) [LM4510SDEV/NOPB](#) [LM5033SD-EVAL](#) [LP38512TS-1.8EV](#) [EVAL-ADM1186-1MBZ](#) [EVAL-ADM1186-2MBZ](#)