

LTM4650EY-1

High Efficiency, PolyPhase 200A Step-Down Power μ Module[®] Regulator 4x LTM4650EY-1, 200A

DESCRIPTION

Demonstration Circuit 2455A-C features PolyPhase[®] design using the **LTM[®]4650EY-1** (B-grade), the high efficiency, high density, dual 25A, switch mode step-down power module regulator. The input voltage is from 4.5V to 15V. The output voltage is jumper selectable from 0.9V to 1.8V. DC2455A-C can deliver nominal 200A output current. As explained in the data sheet, output current de-rating is necessary for certain V_{IN} , V_{OUT} , and thermal conditions. The LTM4650-1 on DC2455A-C always operate in continuous conduction mode. The switching frequency can be programmed through a resistor or can be synchronized to an external clock signal. The board allows the user to program how its output voltage ramps up and down through the

TRACK pin. The output voltage is tightly regulated between “ V_0 ” and “ V_0 ” through remote output voltage sensing which improves output voltage regulation at heavy loads. These features and the availability of the LTM4650EY-1 in a compact 16mm \times 16mm \times 5.01mm BGA package make it ideal for use in many high-density point-of-load regulation applications. The LTM4650-1 data sheet must be read in conjunction with this demo manual for working on or modifying the demo circuit DC2455A-C.

Design files for this circuit board are available at <http://www.linear.com/demo/DC2455A-C>

LT, LTC, LTM, Linear Technology, the Linear logo, μ Module, PolyPhase and TimerBlox are registered trademarks of Linear Technology Corporation. All other trademarks are the property of their respective owners.

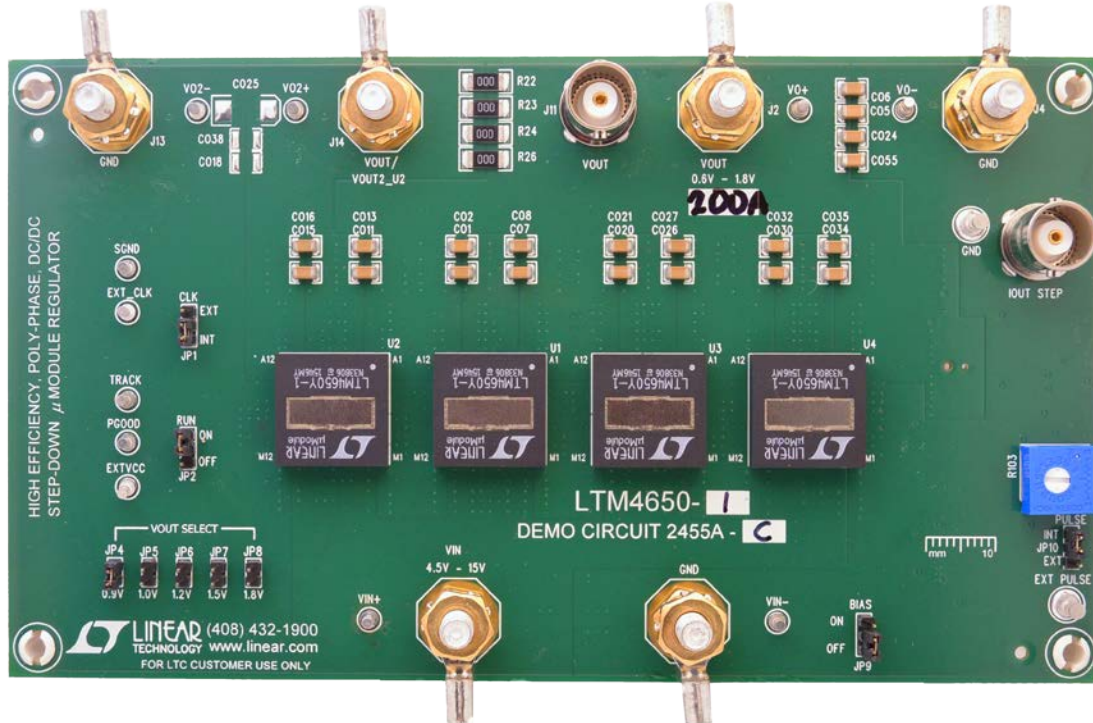

Figure 1. 4x LTM4650-1, 200A PolyPhase LTM4650-1/DC2455A-C Demo Board

DEMO MANUAL DC2455A-C

PERFORMANCE SUMMARY Specifications are at T_A = 25°C

PARAMETER	CONDITIONS / NOTES	VALUE
Input Voltage Range		4.5V ~ 15V
Output Voltage V _{OUT}	V _{IN} = 4.5V to 15V, I _{OUT} = 0A to 200A, JP5: 1.0V	1.0V ± 1.5% (0.985V ~ 1.015V)
Maximum Continuous Output Current	De-rating is necessary for certain V _{IN} , V _{OUT} and thermal conditions, see data sheet for detail.	200A
Default Operating Frequency		500kHz
Resistor Programmable Frequency Range		400kHz – 780kHz
External Clock Sync. Frequency Range		400kHz – 780kHz
Efficiency	V _{IN} = 12V, V _{OUT} = 1.0V, I _{OUT} = 200A, f _{SW} = 500kHz	86.1% See Figure 3
Load Transient	V _{IN} = 12V, V _{OUT} = 1.0V, I _{STEP} = 100A to 150A	< 53mV, See Figure 4

QUICK START PROCEDURE

Demonstration circuit DC2455A-C is easy to set up to evaluate the performance of PolyPhase operation of the LTM4650EY-1. Due to the high input/output current, user should select the proper input supply/load/cable which can sustain the full load operation. It's recommended to pull load current from J2 and J4. The load current pulled from J5 and J6 shouldn't exceed 25A. Please refer to Figure 2 for proper measurement setup and follow the procedure below:

- Place jumpers in the following positions for a typical 1.0V_{OUT} application:

JP1	JP2	JP4~JP8
CLK	RUN	V_{OUT} SELECT
INT	OFF	ON JP5 / 1.0V

- With power off, connect the input power supply, load and meters as shown in Figure 2. Preset the load to 0A and V_{IN} supply to 12V.
- Turn on the power supply at the input. Place JP2 to ON position. The output voltage between “V₀⁺” and “V₀⁻” should be 1.0V ± 1.5% (0.985V~1.015V).
- Once the proper output voltage is established, adjust the load within the operating range and observe the output

voltage regulation, output voltage ripple, efficiency and other parameters. Output voltage ripple should be measured at J11 with BNC cables. 50Ω termination should be set on the oscilloscope or BNC cables.

- (Optional) For optional load transient test, apply an adjustable pulse signal between “IOSTEP CLK” and “GND” test point. Pulse amplitude (3V~3.5V) sets the load step current amplitude. The output transient current can be monitored at the BNC connector J12 (5mV/A). The pulse signal should be very small duty cycle (<10%) to limit the thermal stress on the transient load circuit.
- (Optional) LTM4650-1 can be synchronized to an external clock signal. Place the JP1 jumper on EXT and apply a clock signal (0V~5V, square wave) on the “EXT_CLK” test point.
- (Optional) The outputs of LTM4650-1 can track another supply. The output voltage tracks the voltage on TRACK when a valid signal is applied on the test point.
- (Optional) DC2455A-C can be configured to a dual outputs configuration with V₀ at 175A load current and V₀₂ at 25A load current. Stuff 0Ω resistor on R61 and 0.1μF on C14. Remove R22, R23, R24, R26, R27, R28, R32, R33, R35. Output voltage V₀₂ is set by R37 based on the equation $V_{02} = 0.6V(1+60.4k/R37)$.

QUICK START PROCEDURE

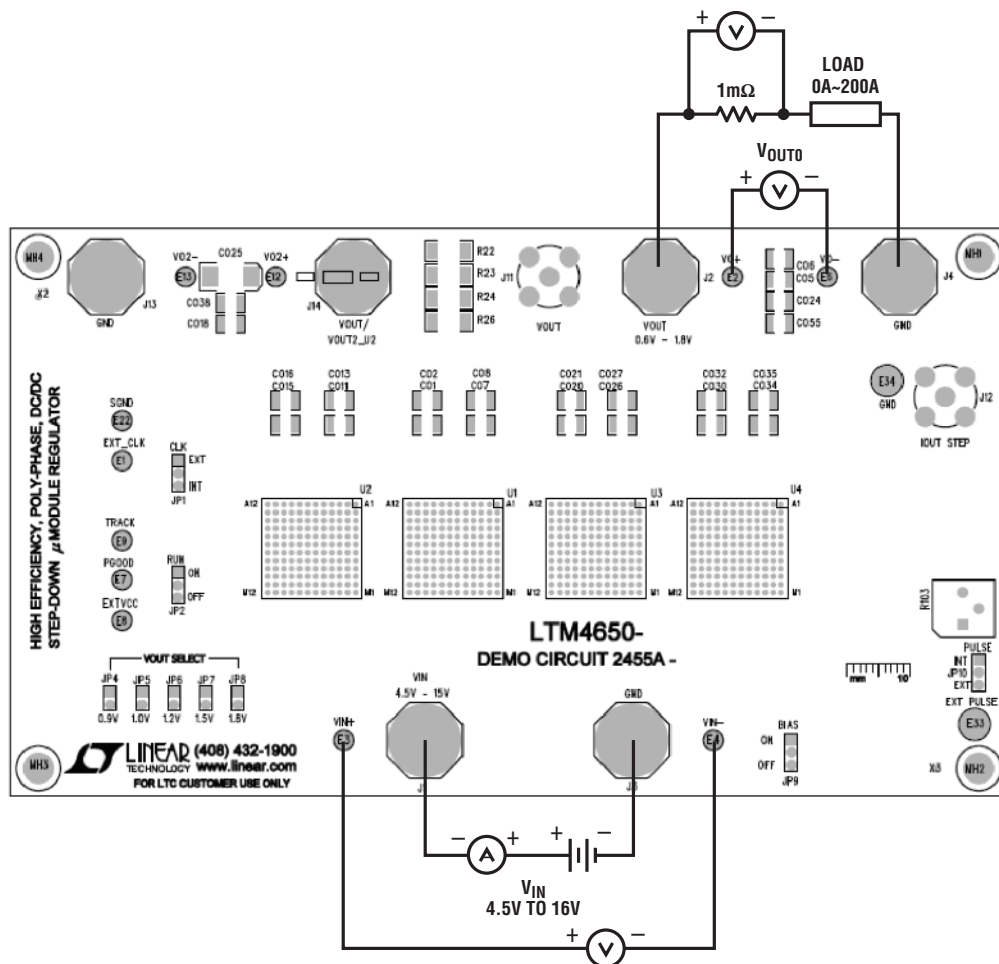

Figure 2. Test Setup of DC2455A-C

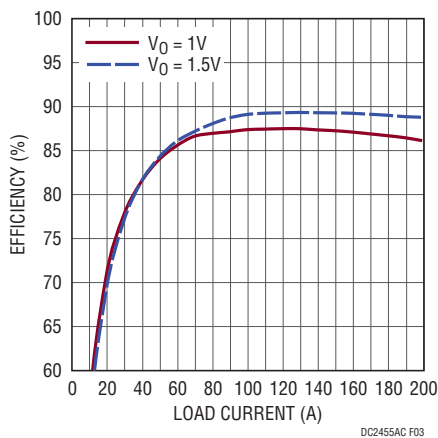

Figure 3. Measured Efficiency $V_{IN} = 12V$, $f_{SW} = 500kHz$

QUICK START PROCEDURE

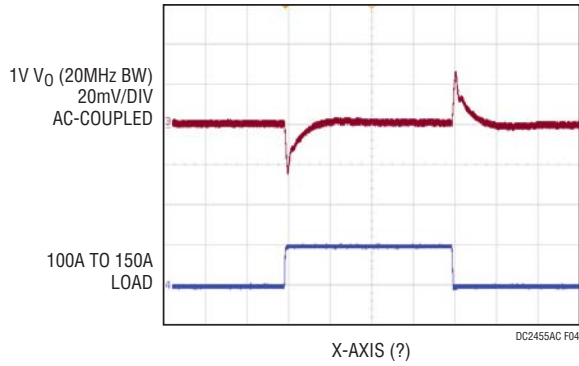

Figure 4. Load Transient 100A to 150A ($V_{IN} = 12V$, $V_{OUT1} = 1V$, $f_{SW} = 500kHz$)

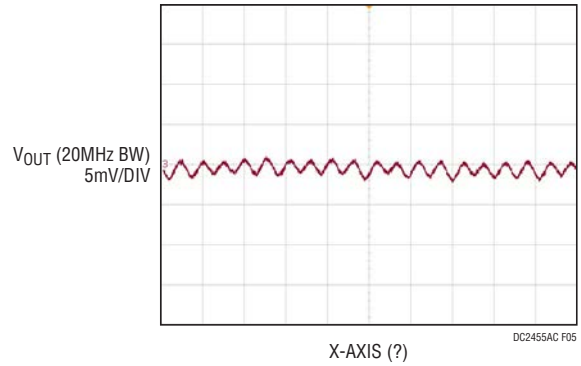

Figure 5. Output Voltage Ripple ($V_{IN} = 12V$, $V_{OUT1} = 1V$, $I_{OUT} = 200A$, $f_{SW} = 500kHz$)

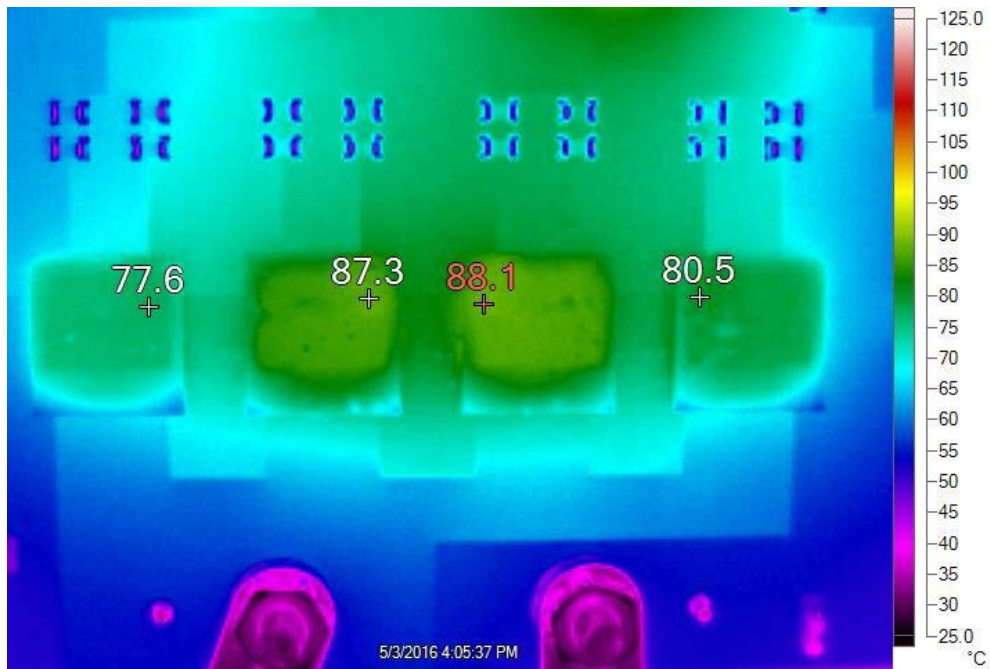

Figure 6. Thermal Performance at $V_{IN} = 12V$, $V_{OUT} = 1V$, $I_{OUT} = 200A$, $T_A = 23.8^\circ C$, 400LFM Air Flow

PARTS LIST

ITEM	QTY	REFERENCE	PART DESCRIPTION	MANUFACTURER/PART NUMBER
Required Circuit Components				
1	1	CIN1	CAP, 150µF 25% 25V ALUM	SUN ELECT., 25HVH150M
2	2	CIN2, CIN11	CAP, 1206 1µF 10% 25V X5R	TAIYO YUDEN, TMK316BJ105KD-T
3	8	CIN3-CIN10	CAP, 1210 22µF 10% 25V X5R	AVX, 12103D226KAT2A
4	8	CIN12-CIN19	CAP, 1210 22µF 10% 25V X5R	AVX, 12103D226KAT2A
5	16	C01, C02, C05, C06, C07, C08, C011, C013, C015, C016, C024, C055, C056, C057, C058, C059	CAP, 1206 220µF 20% 4V X5R	MURATA, GRM31CR60G227ME11L
6	16	C020, C021, C022, C026, C027, C028, C030, C032, C033, C034, C035, C036, C048, C050, C052, C054	CAP, 1206 220µF 20% 4V X5R	MURATA, GRM31CR60G227ME11L
7	1	C1	CAP, 0603 330pF 10% 50V X7R	AVX, 06035C331KAT2A-CT
8	4	C4, C10, C18, C22	CAP, 0603 4.7µF 20% 10V X5R	TAIYO YUDEN, LMK107BJ475MA-T
9	7	C6, C11, C19, C23, COUT26, C42, C43	CAP, 0603 1µF 10% 10V X7R	TAIYO YUDEN, LMK107BJ105KA-T
10	1	C7	CAP, 0603 0.1µF 10% 25V X7R	AVX, 06033C104KAT2A
11	1	C31	CAP, 0603 15nF 10% 50V X7R	AVX, 06035C153KAZ2A
12	1	C39	CAP, 0603 100nF 10% 100V X7R	MURATA, GRM188R72A104KA35D
13	1	C40	CAP, 0603 150pF 5% 50V C0G	AVX, 06035A151JAT2A
14	2	C41, C48	CAP, 1210 100µF 10V X5R	MURATA, GRM32ER61A107ME20L
15	8	C41, C44, C45, C48, C52, C53, C54, C55	CAP, 1210 100µF 10% 6.3V X5R	MURATA, GRM32ER60J107ME20L
16	1	C46	CAP, 1210 10µF 16V X5R	MURATA, GRM32DR61C106KA01L
17	1	C47	CAP, 0603 220pF 10% 50V X7R	AVX, 06035C221KAT2A
18	1	C49	CAP, 0603 47nF 10% 50V X7R	AVX, 06035C473KAZ2A
19	1	L1	IND, 68µH, CDRH105	SUMIDA CDRH105RNP-680N
20	2	Q1, Q2	MOSFET, N-CH D-S 40V TO252	VISHAY, SUD50N04-8M8P-4GE3
21	4	R1, R3, R25, R29	RES, 0603 10Ω 5% 1/10W	VISHAY, CRCW060310R0JNEA
22	9	R2, R9, R14, R21, R31, R39, R43, R47, R51	RES, 0603 121kΩ 1% 1/10W	VISHAY, CRCW0603121KFKEA
23	4	R4, R36, R41, R98	RES, 0603 10kΩ 5% 1/10W	VISHAY, CRCW060310K0JNEA
24	1	R11	RES, 0603 1.74kΩ 1% 1/10W	VISHAY, CRCW06031K74FKEA
25	1	R15	RES, 0603 90.9kΩ 1% 1/10W	VISHAY, CRCW060390K9FKEA
26	1	R16	RES, 0603 60.4kΩ 1% 1/10W	VISHAY, CRCW060360K4FKEA
27	1	R17	RES, 0603 40.2kΩ 1% 1/10W	VISHAY, CRCW060340K2FKEA
28	1	R18	RES, 0603 30.1kΩ 1% 1/10W	VISHAY, CRCW060330K1FKEA
29	1	R89	RES, 0603 2Ω 1% 1/10W	VISHAY, CRCW06032R00FNEA
30	1	R92	RES, 0603 3.3Ω 1% 1/10W	VISHAY, CRCW06033R3FKEA
31	1	R93	RES, 0603 154kΩ 1% 1/10W	VISHAY, CRCW0603154KFKEA
32	1	R94	RES, 0603 1MΩ 5% 1/10W	VISHAY, CRCW06031M00JNEA
33	3	R95, R96, R107	RES, 0603 20kΩ 5% 1/10W	VISHAY, CRCW060320K0JNTA
34	1	R97	RES, 0603 681kΩ 1% 1/10W	VISHAY, CRCW0603681KFKEA
35	1	R99	RES, 0603 301Ω 1% 1/10W	VISHAY, CRCW0603301RFKEA
36	1	R100	RES, 0603 82.5Ω 1% 1/10W	VISHAY, CRCW060382R5FKEA
37	2	R101, R102	RES, 2512 0.010Ω 1% 1W	VISHAY, WSL2512R01000FEA
38	1	R103	RES POT, 5k	BOURNS 3386P-1-502-LF

DEMO MANUAL DC2455A-C

PARTS LIST

ITEM	QTY	REFERENCE	PART DESCRIPTION	MANUFACTURER/PART NUMBER
39	1	R104	RES, 0603 1k Ω 1% 1/10W	VISHAY, CRCW06031K00FKEA
40	1	R105	RES, 0603 105k Ω 1% 1/10W	VISHAY CRCW0603105KFKEA
41	1	R106	RES, 0603 80.6k Ω 1% 1/10W	VISHAY CRCW060380K6FKEA
42	4	U1, U2, U3, U4	IC, VOLTAGE REGULATOR, BGA	LINEAR TECH., LTM4650EY-1#PBF
43	1	U5	IC, TimerBlox [®]	LINEAR TECH., LTC6992IS6-1B#PBF
44	1	U6	IC, OP-AMP, SINGLE, BIPOLAR	LINEAR TECH., LT1803IS5#PBF
45	1	U7	IC, LTC3630EMSE	LINEAR TECH., LTC3630EMSE#PBF

Additional Demo Board Circuit Components

1	0	C03, C09, C014, C017, C018, C038, C040, C042, C045, C046	CAP, 1210 OPTION	OPTION
2	0	C04, C010, C012, C019, C023, C025, C029, C031, C037, C039, C041, C043, C044, C047, C049, C051, C053	CAP, 7343 OPTION	OPTION
3	0	C2, C3, C5, C8, C9, C12, C17, C20, C21, C29, C30, C32	CAP, 0603 OPTION	OPTION
4	0	R5, R7, R8, R10, R30, R37, R38, R42, R44, R48, R49, R50, R52, R53, R55, R61, R64, R87	RES, 0603 OPTION	OPTION
5	13	R6, R19, R20, R27, R28, R32, R33, R35, R40, R45, R62, R63, R91	RES, 0603 0 OHMS JUMPER	VISHAY, CRCW06030000Z0EA
6	0	R13	RES, 0603 OPTION	OPTION
7	1	R34	RES, 0603 0 Ω JUMPER	VISHAY, CRCW06030000Z0EA
8	4	R22, R23, R24, R26	RES, 2010 0 Ω JUMPER	VISHAY, CRCW20100000ZEA9
9	1	R60	RES, 1206 0 Ω JUMPER	VISHAY, CRCW12060000Z0EA

Hardware: For Demo Board Only

1	11	E1-E4, E6-E9, E12, E13, E22	TESTPOINT, TURRET, .063"	MILL MAX, 2308-2-00-80-00-00-07-0
2	0	E5, E10, E11, E14, E15, E16, E17, E18, E23, E24, E25, E26, E27, E28, E29, E30	TEST PAD SMD	
3	2	E33, E34	TESTPOINT, TURRET, .094"	MILL MAX, 2501-2-00-80-00-00-07-0
4	4	JP1, JP2, JP9, JP10	HEADER, 3 PIN 2mm SINGLE ROW	WURTH ELEKTRONIK, 620-003-111-21
5	5	JP4, JP5, JP6, JP7, JP8	HEADER, 2 PIN 2mm SINGLE ROW	WURTH ELEKTRONIK, 620-002-111-21
6	6	J1, J2, J3, J4, J13, J14	STUD, TEST PIN	PEM, KFH-032-10
7	12	J1, J2, J3, J4, J13, J14 (x2)	NUT, BRASS PL # 10-32	ANY, 10-32M/S BR PL
8	6	J1, J2, J3, J4, J13, J14	LUG RING, #10	KEYSTONE, 8205
9	6	J1, J2, J3, J4, J13, J14	WASHER, TIN PLATED BRASS	ANY, #10EXT BZ TN
10	2	J11, J12	CON, BNC, 5 PINS	CONNEX, 112404
11	5	XJP1, XJP2, XJP4, XJP9, XJP10	SHUNT 2mm	WURTH ELEKTRONIK, 608-002-134-21
12	4	MTGS AT 4 CORNERS	STAND-OFF, NYLON	KEYSTONE, 8833

SCHEMATIC DIAGRAM

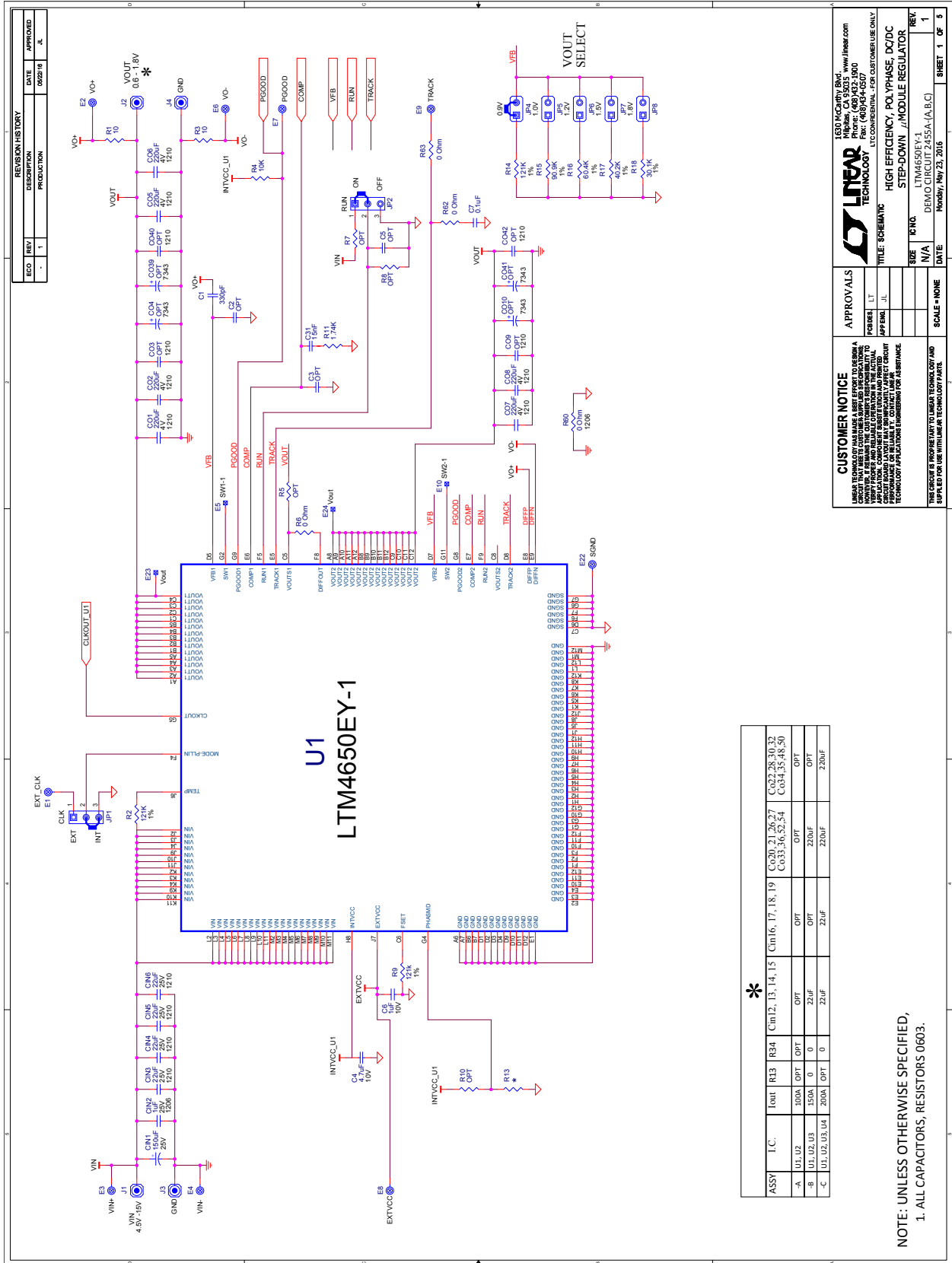

REVISION HISTORY			
ECO	REV	DATE	APPROVED
-	1	02/21/16	JL

CUSTOMER NOTICE
 LINEAR TECHNOLOGY MAKES A BEST EFFORT TO DESIGN A BOARD THAT WILL BE FUNCTIONAL AND OPERATIONAL IN THE ACTUAL MARKET. THE BOARD IS NOT A REPRESENTATIVE OF THE ACTUAL PRODUCT. THE BOARD IS NOT A REPRESENTATIVE OF THE ACTUAL PRODUCT. THE BOARD IS NOT A REPRESENTATIVE OF THE ACTUAL PRODUCT.

APPROVALS

DESIGNED BY	JL
CHECKED BY	JL
DATE	02/21/16

LINEAR TECHNOLOGY
 1630 McCarty Blvd., www.linear.com
 Phone: (408) 432-3900
 Fax: (408) 434-0807
 LTC CONVENTIONAL - FOR CUSTOMER USE ONLY

STEP-DOWN, POLYPHASE, DC/DC
 HIGH EFFICIENCY, POLYPHASE, DC/DC
 LTM4650EY-1
 DEMO CIRCUIT 2455A-1A,B,C
 Monday, May 23, 2016

SCALE	NONE
DATE	02/21/16
SHEET	1 OF 5

NOTE: UNLESS OTHERWISE SPECIFIED,
 1. ALL CAPACITORS, RESISTORS 0603.

SCHEMATIC DIAGRAM

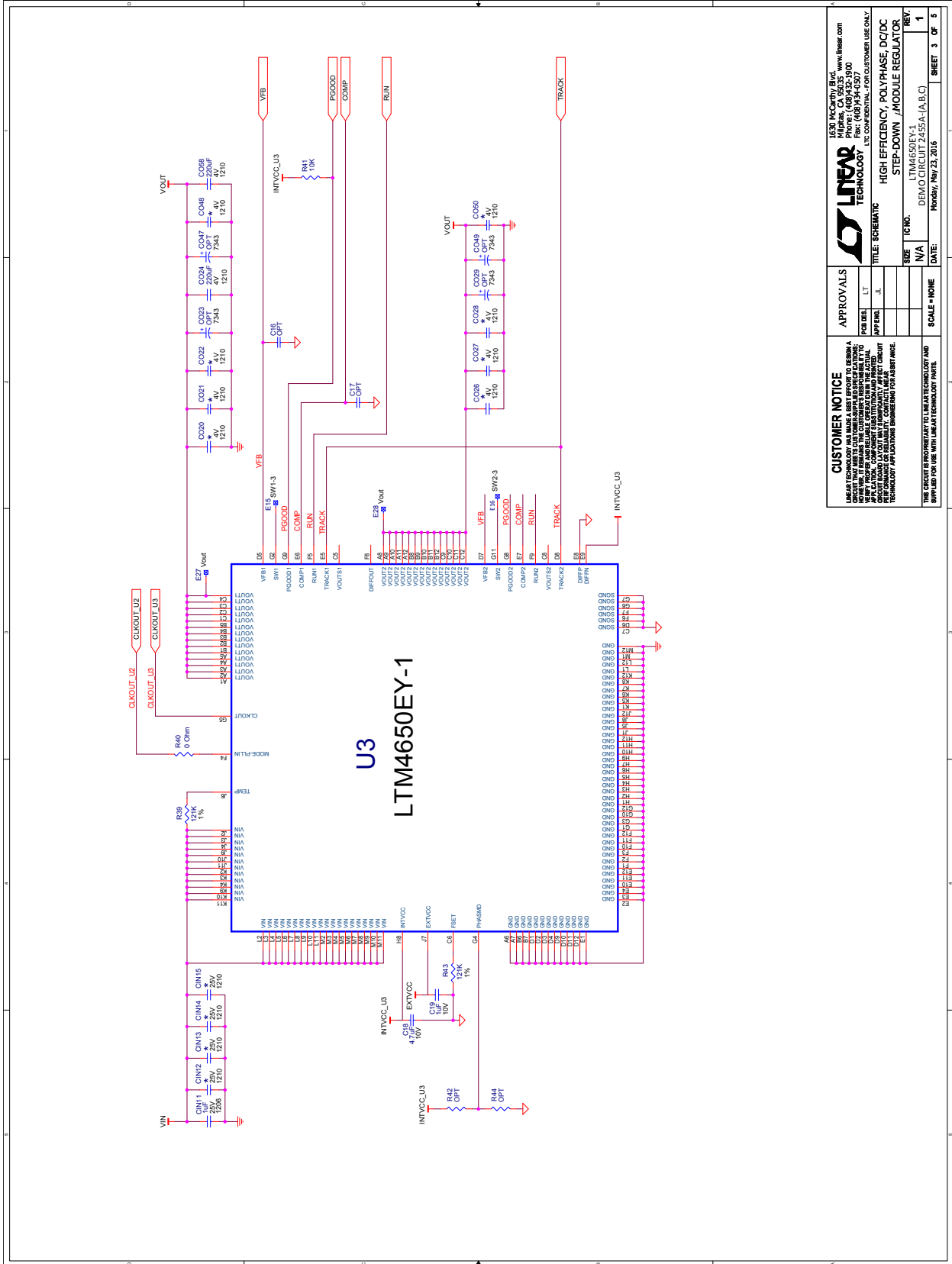

CUSTOMER NOTICE
 THE CIRCuits ARE PROPRIETARY TO LINEAR TECHNOLOGY AND SUPPLIED FOR USE WITH LINEAR TECHNOLOGY PARTS.
 ANY REUSE OR MODIFICATION OF THESE SCHEMATICs WITHOUT THE WRITTEN PERMISSION OF LINEAR TECHNOLOGY IS PROHIBITED.
 THIS DOCUMENT IS UNCLASSIFIED AND INTENDED FOR GENERAL DISTRIBUTION. IT IS NOT TO BE REPRODUCED OR TRANSMITTED IN ANY FORM OR BY ANY MEANS, ELECTRONIC OR MECHANICAL, INCLUDING PHOTOCOPYING, RECORDING, OR BY ANY INFORMATION STORAGE AND RETRIEVAL SYSTEM, WITHOUT THE WRITTEN PERMISSION OF LINEAR TECHNOLOGY.

APPROVALS
 PBR: J.L.
 J.P.
 J.P.
 J.P.

LINEAR TECHNOLOGY
 1630 McCarthy Blvd.
 Milpitas, CA 95035
 Phone: (415) 994-2200
 Fax: (415) 994-2099
 www.linear.com

TITLE: SCHEMATIC
HIGH EFFICIENCY, POLYPHASE, DC/DC STEP-DOWN /MODULE REGULATOR

REF: 16NO.
LTM4650EY-1
DEMO CIRCUIT 2455A-(A,B,C)
DATE: Monday, May 23, 2016

SCALE: NONE
SHEET 3 OF 5

DEMO MANUAL DC2455A-C

DEMONSTRATION BOARD IMPORTANT NOTICE

Linear Technology Corporation (LTC) provides the enclosed product(s) under the following **AS IS** conditions:

This demonstration board (DEMO BOARD) kit being sold or provided by Linear Technology is intended for use for **ENGINEERING DEVELOPMENT OR EVALUATION PURPOSES ONLY** and is not provided by LTC for commercial use. As such, the DEMO BOARD herein may not be complete in terms of required design-, marketing-, and/or manufacturing-related protective considerations, including but not limited to product safety measures typically found in finished commercial goods. As a prototype, this product does not fall within the scope of the European Union directive on electromagnetic compatibility and therefore may or may not meet the technical requirements of the directive, or other regulations.

If this evaluation kit does not meet the specifications recited in the DEMO BOARD manual the kit may be returned within 30 days from the date of delivery for a full refund. **THE FOREGOING WARRANTY IS THE EXCLUSIVE WARRANTY MADE BY THE SELLER TO BUYER AND IS IN LIEU OF ALL OTHER WARRANTIES, EXPRESSED, IMPLIED, OR STATUTORY, INCLUDING ANY WARRANTY OF MERCHANTABILITY OR FITNESS FOR ANY PARTICULAR PURPOSE. EXCEPT TO THE EXTENT OF THIS INDEMNITY, NEITHER PARTY SHALL BE LIABLE TO THE OTHER FOR ANY INDIRECT, SPECIAL, INCIDENTAL, OR CONSEQUENTIAL DAMAGES.**

The user assumes all responsibility and liability for proper and safe handling of the goods. Further, the user releases LTC from all claims arising from the handling or use of the goods. Due to the open construction of the product, it is the user's responsibility to take any and all appropriate precautions with regard to electrostatic discharge. Also be aware that the products herein may not be regulatory compliant or agency certified (FCC, UL, CE, etc.).

No License is granted under any patent right or other intellectual property whatsoever. **LTC assumes no liability for applications assistance, customer product design, software performance, or infringement of patents or any other intellectual property rights of any kind.**

LTC currently services a variety of customers for products around the world, and therefore this transaction **is not exclusive**.

Please read the DEMO BOARD manual prior to handling the product. Persons handling this product must have electronics training and observe good laboratory practice standards. **Common sense is encouraged.**

This notice contains important safety information about temperatures and voltages. For further safety concerns, please contact a LTC application engineer.

Mailing Address:

Linear Technology
1630 McCarthy Blvd.
Milpitas, CA 95035

Copyright © 2004, Linear Technology Corporation

X-ON Electronics

Largest Supplier of Electrical and Electronic Components

Click to view similar products for [Power Management IC Development Tools](#) category:

Click to view products by [Analog Devices](#) manufacturer:

Other Similar products are found below :

[EVAL-ADM1168LQEBZ](#) [EVB-EP5348UI](#) [MIC23451-AAAYFL EV](#) [MIC5281YMME EV](#) [DA9063-EVAL](#) [ADP122-3.3-EVALZ](#) [ADP130-0.8-EVALZ](#) [ADP130-1.2-EVALZ](#) [ADP130-1.5-EVALZ](#) [ADP130-1.8-EVALZ](#) [ADP1714-3.3-EVALZ](#) [ADP1716-2.5-EVALZ](#) [ADP1740-1.5-EVALZ](#) [ADP1752-1.5-EVALZ](#) [ADP1828LC-EVALZ](#) [ADP1870-0.3-EVALZ](#) [ADP1871-0.6-EVALZ](#) [ADP1873-0.6-EVALZ](#) [ADP1874-0.3-EVALZ](#) [ADP1882-1.0-EVALZ](#) [ADP199CB-EVALZ](#) [ADP2102-1.25-EVALZ](#) [ADP2102-1.875EVALZ](#) [ADP2102-1.8-EVALZ](#) [ADP2102-2-EVALZ](#) [ADP2102-3-EVALZ](#) [ADP2102-4-EVALZ](#) [ADP2106-1.8-EVALZ](#) [ADP2147CB-110EVALZ](#) [AS3606-DB](#) [BQ24010EVM](#) [BQ24075TEVM](#) [BQ24155EVM](#) [BQ24157EVM-697](#) [BQ24160EVM-742](#) [BQ24296MEVM-655](#) [BQ25010EVM](#) [BQ3055EVM](#) [NCV891330PD50GEVB](#) [ISLUSBI2CKIT1Z](#) [LM2744EVAL](#) [LM2854EVAL](#) [LM3658SD-AEV/NOPB](#) [LM3658SDEV/NOPB](#) [LM3691TL-1.8EV/NOPB](#) [LM4510SDEV/NOPB](#) [LM5033SD-EVAL](#) [LP38512TS-1.8EV](#) [EVAL-ADM1186-1MBZ](#) [EVAL-ADM1186-2MBZ](#)