

## LT8646S 65V, 8A Synchronous Step-Down Silent Switcher 2

### DESCRIPTION

Demonstration circuit 2660A is a 65V, 8A synchronous step-down second generation Silent Switcher® with spread spectrum frequency modulation featuring the [LT®8646S](#). The demo board is designed for 5V output from a 5.6V to 65V input. The wide input range allows a variety of input sources, such as automotive batteries and industrial supplies. The LT8646S is a compact, ultralow emission, high efficiency, and high speed synchronous monolithic step-down switching regulator. The integrated bypass capacitors optimize all the fast current loops and make it easier to minimize EMI/EMC emissions by reducing layout sensitivity. Selectable spread spectrum mode can further improve EMI/EMC performance. Fast minimum on-time of 40ns enables high  $V_{IN}$  to low  $V_{OUT}$  conversion at high frequency.

The LT8646S switching frequency can be programmed either via oscillator resistor or external clock over a 200kHz to 2.2MHz range. The default frequency of demo circuit 2660A is 2MHz. The SYNC pin on the demo board is grounded (JP1 at BURST position) by default for low ripple burst mode operation. To synchronize to an external clock, move JP1 to SYNC and apply the external clock to the SYNC terminal. Spread spectrum mode and pulse skipping mode can be selected respectively by moving JP1 shunt. Figure 1 shows the efficiency of the circuit at 12V input and 24V input in Burst Mode Operation (input from VIN terminal to bypass the EMI filter). Figure 2 shows the LT8646S temperature rising on DC2660A demo board under different load conditions. The rated

maximum load current is 8A, while derating is necessary for certain input voltage and thermal conditions. Low switching frequency can extend the output load capability by reducing the power dissipations. Figure 3 shows the temperature rising at 500kHz switching frequency.

The demo board has an EMI filter installed. The EMI performance of the board (with EMI filter) is shown on Figure 4. The red line in Radiated EMI Performance is CISPR25 Class 5 peak limit. The figure shows that the circuit passes the test with a wide margin. To achieve EMI/EMC performance as shown in Figure 4, the input EMI filter is required and the input voltage should be applied at VEMI terminal. An inductor can be added in the EMI filter to further reduce the conducted emission. The EMI filter can be bypassed by applying the input voltage at VIN terminal.

The LT8646S data sheet gives a complete description of the part, operation and application information. The data sheet must be read in conjunction with this demo manual for demo circuit 2660A. The LT8646S is assembled in a 6mm × 4mm LQFN package with exposed pads for low thermal resistance. The layout recommendations for low EMI operation and maximum thermal performance are available in the data sheet section Low EMI PCB Layout and Thermal Considerations.

**Design files for this circuit board are available at <http://www.linear.com/demo/DC2660A>**

All registered trademarks and trademarks are the property of their respective owners.

### PERFORMANCE SUMMARY Specifications are at $T_A = 25^\circ\text{C}$

SYMBOL	PARAMETER	CONDITIONS	MIN	TYP	MAX	UNITS
$V_{IN\_EMI}$	Input Supply Range with EMI Filter		5.6		65	V
$V_{OUT}$	Output Voltage		4.85	5	5.15	V
$I_{OUT}$	Maximum Output Current	Derating is Necessary for Certain $V_{IN}$ and Thermal Conditions	8			A
$f_{SW}$	Switching Frequency		1.85	2	2.15	MHz
EFF	Efficiency	$V_{IN} = 12V, I_{OUT} = 4A$		93.8		%

dc2660af

## DESCRIPTION

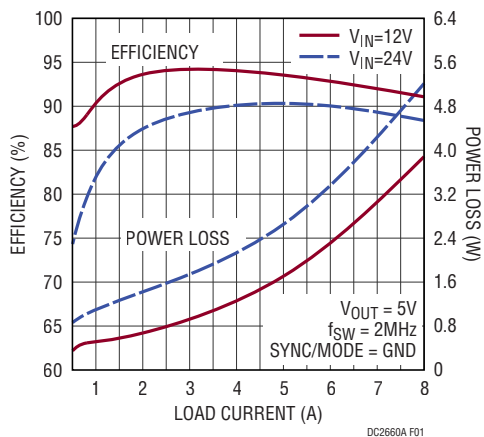

**Figure 1. LT8646S Demo Circuit DC2660A Efficiency vs Load Current (Input from VIN Terminal)**

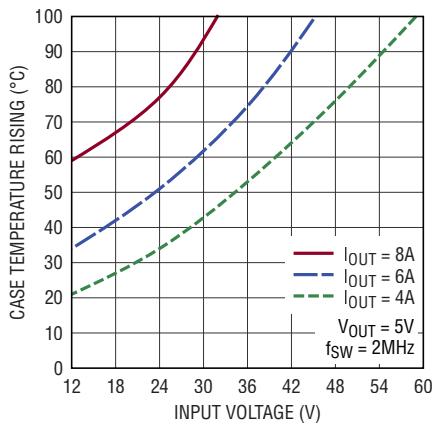

**Figure 2. LT8646S Demo Circuit DC2660A Case Temperature Rising vs Input Voltage (2MHz)**

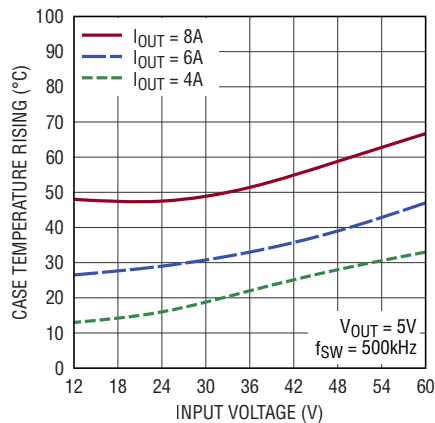

**Figure 3. LT8646S Demo Circuit DC2660A Case Temperature Rising vs Input Voltage (500kHz)**

DESCRIPTION

Conducted EMI Performance

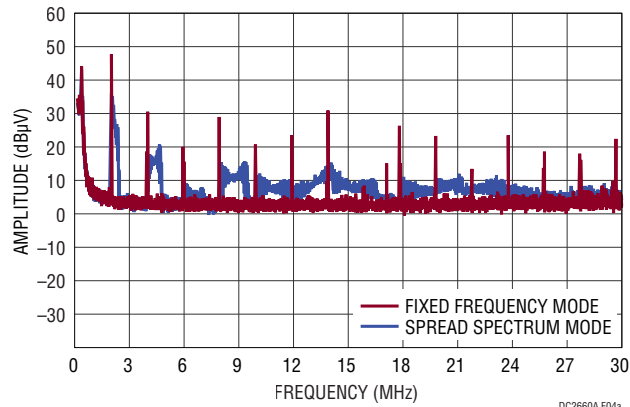

(WITH EMI FILTER INSTALLED)  
14V INPUT TO 5V OUTPUT AT 4A,  $f_{SW} = 2\text{MHz}$

DC2660A F04a

Radiated EMI Performance  
(CISPR25 Radiated Emission Test with Class 5 Peak Limits)

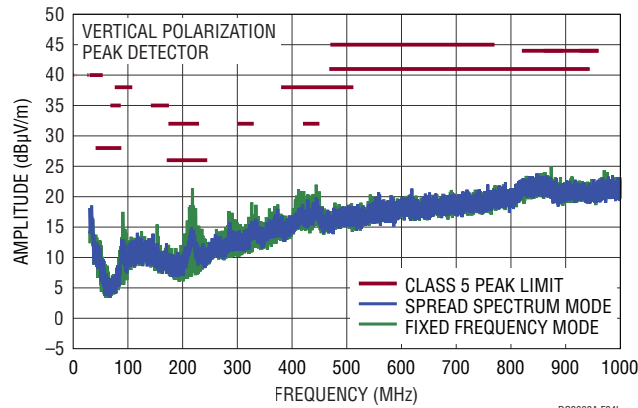

DC2660A F04b

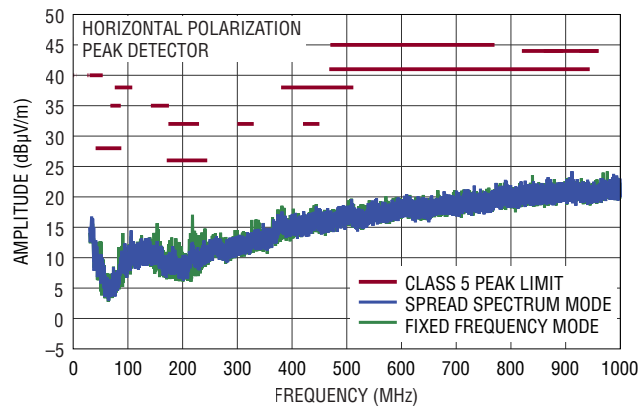

DC2660A F04c

(WITH EMI FILTER INSTALLED)  
14V INPUT TO 5V OUTPUT AT 4A,  $f_{SW} = 2\text{MHz}$

Figure 4. LT8646S Demo Circuit DC2660A EMI Performance  
(14V Input from VEMI, with EMI filter,  $I_{OUT} = 4\text{A}$ )

## QUICK START PROCEDURE

Demonstration circuit 2660A is easy to set up to evaluate the performance of the LT8646S. Refer to Figure 5 for proper measurement equipment setup and follow the procedure below:

NOTE: When measuring the input or output voltage ripple, care must be taken to avoid a long ground lead on the oscilloscope probe. Measure the output voltage ripple by touching the probe tip directly across the output capacitor. See Figure 6 for the proper scope technique. Figure 7 shows the output voltage ripple measured at the output capacitor C9.

1. Place JP1 on BURST position.
2. With power off, connect the input power supply to VEMI and GND. If the input EMI filter is not desired, connect the input power supply to VIN and GND.
3. With power off, connect the load from  $V_{OUT}$  to GND.
4. Turn on the power at the input.

NOTE: Make sure that the input voltage does not exceed 65V.

5. Check for the proper output voltage ( $V_{OUT} = 5V$ ).  
NOTE: If there is no output, temporarily disconnect the load to make sure that the load is not set too high or is shorted.
6. Once the proper output voltage is established, adjust the load within the operating ranges and observe the output voltage regulation, ripple voltage, efficiency and other parameters.
7. An external clock can be added to the SYNC terminal when SYNC function is used (JP1 on the SYNC position). Please make sure that R2 should be chose to set the LT8646S switching frequency equal to or below the lowest SYNC frequency. JP1 can also set LT8646S in spread spectrum mode (JP1 on the spread-spectrum position) or pulse skipping mode (JP1 on the pulse-skipping position).

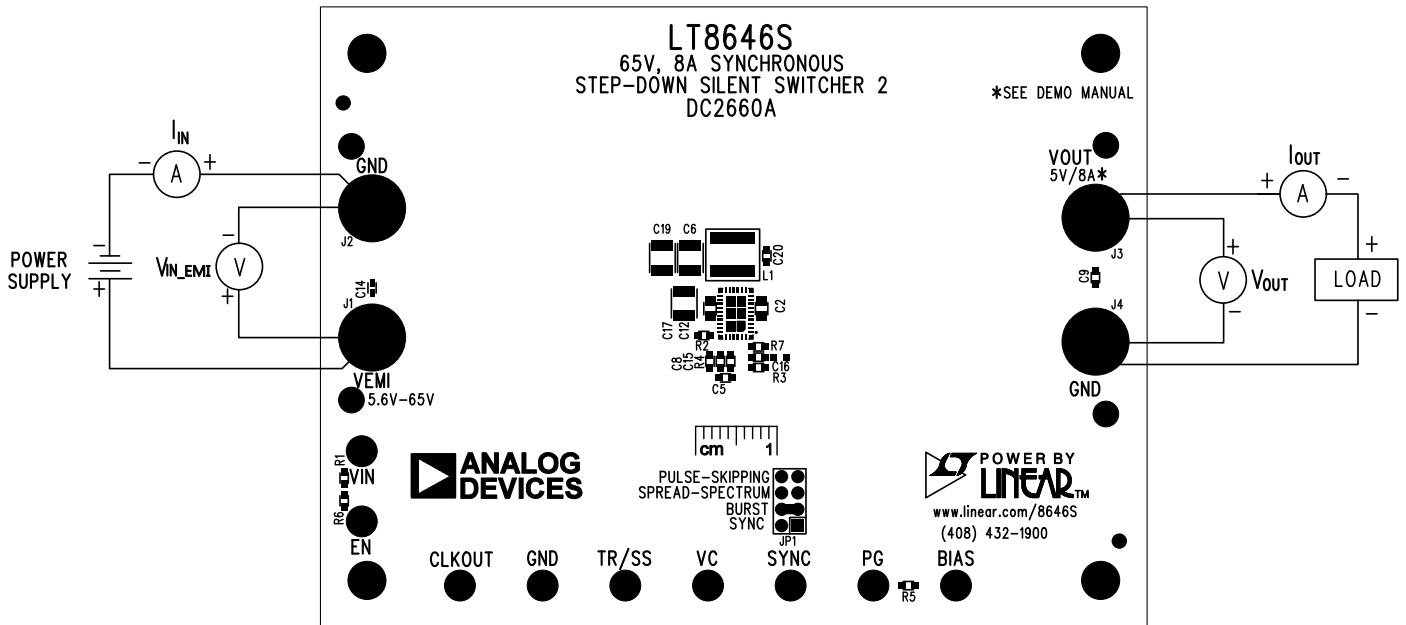
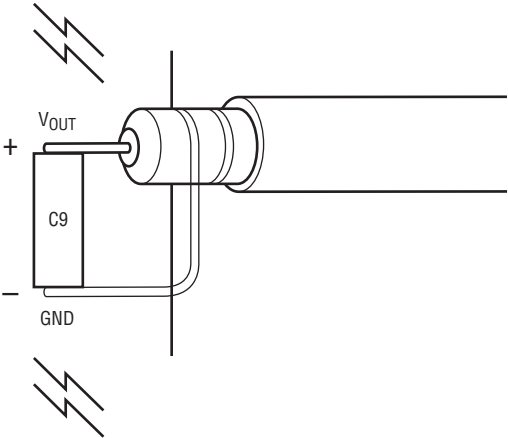
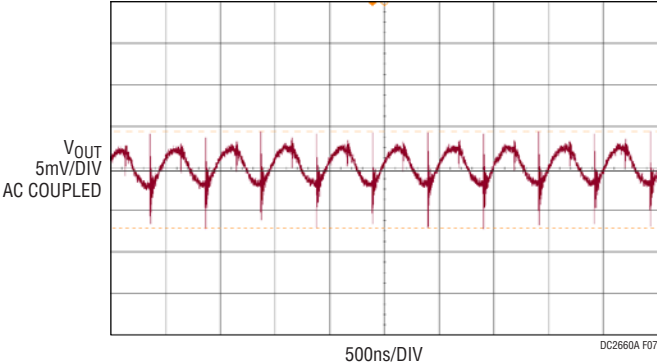

Figure 5. Proper Measurement Equipment Setup

**QUICK START PROCEDURE**



**Figure 6. Measuring Output Ripple at Output Capacitor C9**



**Figure 7. LT8646S Demo Circuit DC2660A Output Voltage Ripple (12V Input, I<sub>OUT</sub> = 8A, Full BW)**

# DEMO MANUAL DC2660A

## PARTS LIST

ITEM	QTY	REFERENCE	PART DESCRIPTION	MANUFACTURER/PART NUMBER
<b>Required Circuit Components</b>				
1	2	C2, C12	CAP., X7R, 0.47 $\mu$ F, 100V, 10%, 0805	MURATA, GRM21BR72A474KA73L
2	1	C5	CAP., C0G, 330pF, 50V, 5%, 0603	MURATA, GRM1885C1H331JA01D
3	1	C6	CAP., X5R, 100 $\mu$ F, 10V, 20%, 1210	MURATA, GRM32ER61A107ME20L
4	1	C8	CAP., X7R, 0.1 $\mu$ F, 25V, 10%, 0603	MURATA, GRM188R71E104KA01D
5	1	C9	CAP., X5R, 10 $\mu$ F, 25V, 20%, 0603	MURATA, GRM188R61E106MA73D
6	1	C16	CAP., C0G, 4.7pF, 50V, $\pm$ 0.25pF, 0603	MURATA, GRM1885C1H4R7CA01D
7	1	C17	CAP., X7S, 4.7 $\mu$ F, 100V, 10%, 1210	MURATA, GRJ32DC72A475KE11L
8	1	C20	CAP., X5R, 1 $\mu$ F, 16V, 10%, 0603	MURATA, GRM188R61C105KA12D
9	1	L1	INDUCTOR, 1.0 $\mu$ H, XEL6030	COILCRAFT, XEL6030-102MEC
10	2	R1, R5	RES., CHIP, 100k, 1/10W, 1%, 0603	VISHAY, CRCW0603100KFKEA
11	1	R2	RES., CHIP, 17.8k, 1/10W, 1%, 0603	VISHAY, CRCW060317K8FKEA
12	1	R3	RES., CHIP, 243k, 1/10W, 1%, 0603	VISHAY, CRCW0603243KFKEA
13	1	R4	RES., CHIP, 7.5k, 1/10W, 1%, 0603	VISHAY, CRCW06037K50FKEA
14	1	R7	RES., CHIP, 1M, 1/10W, 1%, 0603	VISHAY, CRCW06031M00FKEA
15	1	U1	I.C., 65V, 8A SYNC BUCK, 6mm $\times$ 4mm LQFN	LINEAR TECH., LT8646SEV#PBF
<b>Additional Demo Board Circuit Components</b>				
1	1	C1	CAP., ALUM 22 $\mu$ F, 100V, 20%	SUNCON, 100CE22BS
2	2	C3,C10	CAP., X7R, 2.2 $\mu$ F, 100V, 10%, 1210	MURATA, GRM32ER72A225KA35L
3	1	C4	CAP., X7R, 0.1 $\mu$ F, 100V, 10%, 0603	MURATA, GRM188R72A104KA35D
4	1	C14	CAP., X5R, 0.1 $\mu$ F, 100V, 10%, 0402	MURATA, GRM155R62A104KE14D
5	0	C15, C18 (OPT)	CAP., 0603	
6	0	C19 (OPT)	CAP., 1210	
7	1	FB1	FERRITE BEAD, 0.006 $\Omega$ 8A, 1812	WURTH ELEKTRONIK, 74279226101
8	0	R6 (OPT)	RES., OPTION, 0603	
9	1	R8	RES., CHIP, 0 $\Omega$ , 1/10W, 1%, 0603	VISHAY, CRCW06030000Z0EA
<b>Hardware: For Demo Board Only</b>				
1	9	E1, E5-E9, E11, E14-E15	TESTPOINT, TURRET, .094"	MILL-MAX, 2501-2-00-80-00-00-07-0
2	4	E2, E10, E12, E13	TESTPOINT, TURRET, .061"	MILL-MAX, 2308-2-00-80-00-00-07-0
3	1	JP1	2 $\times$ 4, 2mm DOUBLE ROW HEADER	WURTH ELEKTRONIK, 62000821121
4	1	XJP1	SHUNT, 2mm CENTER	WURTH ELEKTRONIK, 60800213421
5	4	J1-J4	JACK BANANA	KEYSTONE, 575-4
6	4	MH1-MH4	STAND-OFF, NYLON 0.50" TALL	WURTH ELEKTRONIK, 702935000

**SCHEMATIC DIAGRAM**

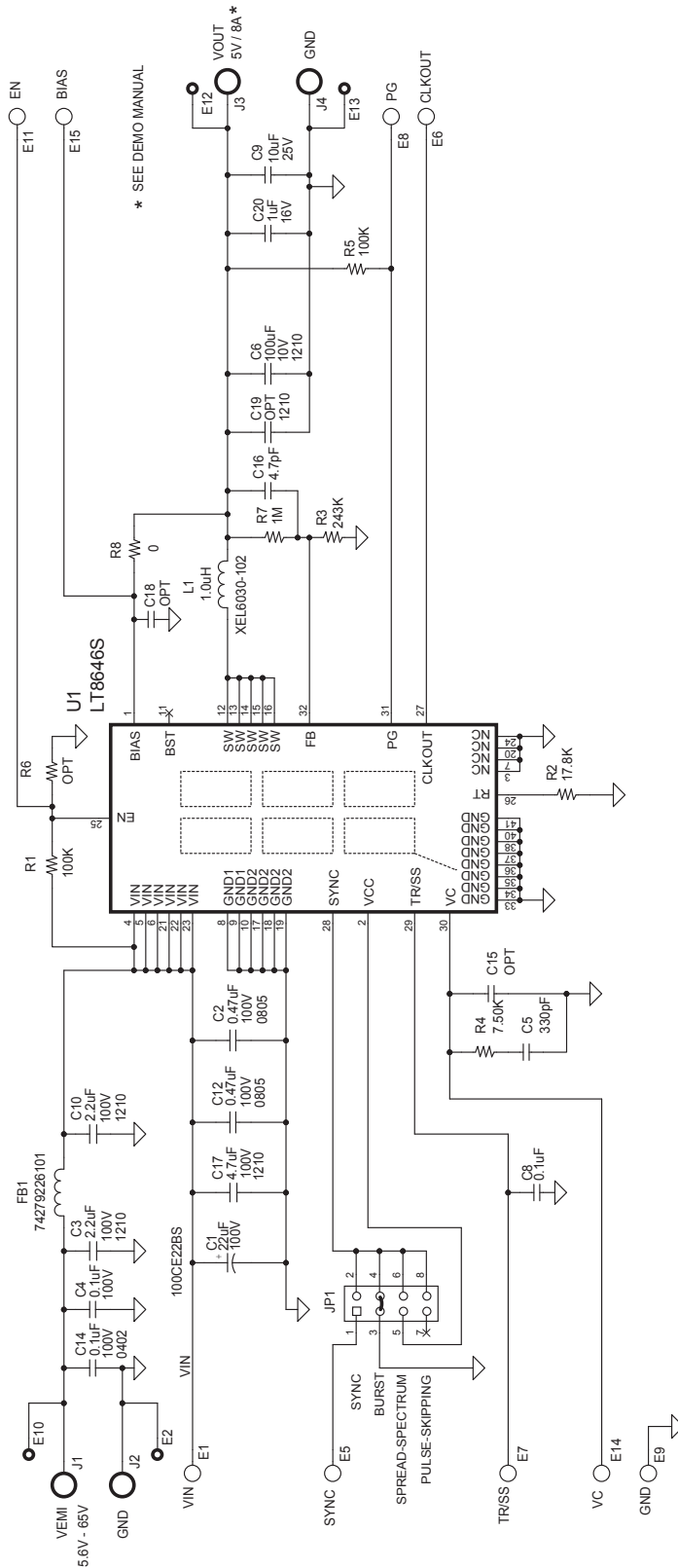

NOTES: UNLESS OTHERWISE SPECIFIED

- 1. ALL RESISTORS ARE 0603.
- ALL CAPACITORS ARE 0603.



## ESD Caution

**ESD (electrostatic discharge) sensitive device.** Charged devices and circuit boards can discharge without detection. Although this product features patented or proprietary protection circuitry, damage may occur on devices subjected to high energy ESD. Therefore, proper ESD precautions should be taken to avoid performance degradation or loss of functionality.

## Legal Terms and Conditions

By using the evaluation board discussed herein (together with any tools, components documentation or support materials, the "Evaluation Board"), you are agreeing to be bound by the terms and conditions set forth below ("Agreement") unless you have purchased the Evaluation Board, in which case the Analog Devices Standard Terms and Conditions of Sale shall govern. Do not use the Evaluation Board until you have read and agreed to the Agreement. Your use of the Evaluation Board shall signify your acceptance of the Agreement. This Agreement is made by and between you ("Customer") and Analog Devices, Inc. ("ADI"), with its principal place of business at One Technology Way, Norwood, MA 02062, USA. Subject to the terms and conditions of the Agreement, ADI hereby grants to Customer a free, limited, personal, temporary, non-exclusive, non-sublicensable, non-transferable license to use the Evaluation Board FOR EVALUATION PURPOSES ONLY. Customer understands and agrees that the Evaluation Board is provided for the sole and exclusive purpose referenced above, and agrees not to use the Evaluation Board for any other purpose. Furthermore, the license granted is expressly made subject to the following additional limitations: Customer shall not (i) rent, lease, display, sell, transfer, assign, sublicense, or distribute the Evaluation Board; and (ii) permit any Third Party to access the Evaluation Board. As used herein, the term "Third Party" includes any entity other than ADI, Customer, their employees, affiliates and in-house consultants. The Evaluation Board is NOT sold to Customer; all rights not expressly granted herein, including ownership of the Evaluation Board, are reserved by ADI. CONFIDENTIALITY. This Agreement and the Evaluation Board shall all be considered the confidential and proprietary information of ADI. Customer may not disclose or transfer any portion of the Evaluation Board to any other party for any reason. Upon discontinuation of use of the Evaluation Board or termination of this Agreement, Customer agrees to promptly return the Evaluation Board to ADI. ADDITIONAL RESTRICTIONS. Customer may not disassemble, decompile or reverse engineer chips on the Evaluation Board. Customer shall inform ADI of any occurred damages or any modifications or alterations it makes to the Evaluation Board, including but not limited to soldering or any other activity that affects the material content of the Evaluation Board. Modifications to the Evaluation Board must comply with applicable law, including but not limited to the RoHS Directive. TERMINATION. ADI may terminate this Agreement at any time upon giving written notice to Customer. Customer agrees to return to ADI the Evaluation Board at that time. LIMITATION OF LIABILITY. THE EVALUATION BOARD PROVIDED HEREUNDER IS PROVIDED "AS IS" AND ADI MAKES NO WARRANTIES OR REPRESENTATIONS OF ANY KIND WITH RESPECT TO IT. ADI SPECIFICALLY DISCLAIMS ANY REPRESENTATIONS, ENDORSEMENTS, GUARANTEES, OR WARRANTIES, EXPRESS OR IMPLIED, RELATED TO THE EVALUATION BOARD INCLUDING, BUT NOT LIMITED TO, THE IMPLIED WARRANTY OF MERCHANTABILITY, TITLE, FITNESS FOR A PARTICULAR PURPOSE OR NON-INFRINGEMENT OF INTELLECTUAL PROPERTY RIGHTS. IN NO EVENT WILL ADI AND ITS LICENSORS BE LIABLE FOR ANY INCIDENTAL, SPECIAL, INDIRECT, OR CONSEQUENTIAL DAMAGES RESULTING FROM CUSTOMER'S POSSESSION OR USE OF THE EVALUATION BOARD, INCLUDING BUT NOT LIMITED TO LOST PROFITS, DELAY COSTS, LABOR COSTS OR LOSS OF GOODWILL. ADI'S TOTAL LIABILITY FROM ANY AND ALL CAUSES SHALL BE LIMITED TO THE AMOUNT OF ONE HUNDRED US DOLLARS (\$100.00). EXPORT. Customer agrees that it will not directly or indirectly export the Evaluation Board to another country, and that it will comply with all applicable United States federal laws and regulations relating to exports. GOVERNING LAW. This Agreement shall be governed by and construed in accordance with the substantive laws of the Commonwealth of Massachusetts (excluding conflict of law rules). Any legal action regarding this Agreement will be heard in the state or federal courts having jurisdiction in Suffolk County, Massachusetts, and Customer hereby submits to the personal jurisdiction and venue of such courts. The United Nations Convention on Contracts for the International Sale of Goods shall not apply to this Agreement and is expressly disclaimed.



## X-ON Electronics

Largest Supplier of Electrical and Electronic Components

*Click to view similar products for [Power Management IC Development Tools](#) category:*

*Click to view products by [Analog Devices](#) manufacturer:*

Other Similar products are found below :

[EVAL-ADM1168LQEBZ](#) [EVB-EP5348UI](#) [MIC23451-AAAYFL EV](#) [MIC5281YMME EV](#) [DA9063-EVAL](#) [ADP122-3.3-EVALZ](#) [ADP130-0.8-EVALZ](#) [ADP130-1.2-EVALZ](#) [ADP130-1.5-EVALZ](#) [ADP130-1.8-EVALZ](#) [ADP1714-3.3-EVALZ](#) [ADP1716-2.5-EVALZ](#) [ADP1740-1.5-EVALZ](#) [ADP1752-1.5-EVALZ](#) [ADP1828LC-EVALZ](#) [ADP1870-0.3-EVALZ](#) [ADP1871-0.6-EVALZ](#) [ADP1873-0.6-EVALZ](#) [ADP1874-0.3-EVALZ](#) [ADP1882-1.0-EVALZ](#) [ADP199CB-EVALZ](#) [ADP2102-1.25-EVALZ](#) [ADP2102-1.875EVALZ](#) [ADP2102-1.8-EVALZ](#) [ADP2102-2-EVALZ](#) [ADP2102-3-EVALZ](#) [ADP2102-4-EVALZ](#) [ADP2106-1.8-EVALZ](#) [ADP2147CB-110EVALZ](#) [AS3606-DB](#) [BQ24010EVM](#) [BQ24075TEVM](#) [BQ24155EVM](#) [BQ24157EVM-697](#) [BQ24160EVM-742](#) [BQ24296MEVM-655](#) [BQ25010EVM](#) [BQ3055EVM](#) [NCV891330PD50GEVB](#) [ISLUSBI2CKIT1Z](#) [LM2744EVAL](#) [LM2854EVAL](#) [LM3658SD-AEV/NOPB](#) [LM3658SDEV/NOPB](#) [LM3691TL-1.8EV/NOPB](#) [LM4510SDEV/NOPB](#) [LM5033SD-EVAL](#) [LP38512TS-1.8EV](#) [EVAL-ADM1186-1MBZ](#) [EVAL-ADM1186-2MBZ](#)