

## FEATURES

- **Wide Input Voltage Range: 3V to 80V**
- **Low Quiescent Current: 30μA**
- **Low Dropout Voltage: 300mV**
- **Output Current: 50mA**
- **Thermally Enhanced 8-Lead MSOP Package**
- No Protection Diodes Needed
- Fixed Output Voltage: 5V (LT3010-5)
- Adjustable Output from 1.275V to 60V (LT3010)
- 1μA Quiescent Current in Shutdown
- Stable with 1μF Output Capacitor
- Stable with Aluminum, Tantalum or Ceramic Capacitors
- Reverse-Battery Protection
- No Reverse Current Flow from Output
- Thermal Limiting
- AEC-Q100 Qualified for Automotive Applications

## APPLICATIONS

- Low Current High Voltage Regulators
- Regulator for Battery-Powered Systems
- Telecom Applications
- Automotive Applications

## DESCRIPTION

The **LT<sup>®</sup>3010** is a high voltage, micropower low dropout linear regulator. The device is capable of supplying 50mA output current with a dropout voltage of 300mV. Designed for use in battery-powered or high voltage systems, the low quiescent current (30μA operating and 1μA in shutdown) makes the LT3010 an ideal choice. Quiescent current is also well controlled in dropout.

Other features of the LT3010 include the ability to operate with very small output capacitors. The regulators are stable with only 1μF on the output while most older devices require between 10μF and 100μF for stability. Small ceramic capacitors can be used without the necessary addition of ESR as is common with other regulators. Internal protection circuitry includes reverse-battery protection, current limiting, thermal limiting and reverse current protection.

The device is available in a fixed output voltage of 5V and as an adjustable device with a 1.275V reference voltage. The LT3010 regulator is available in the 8-lead MSOP package with an exposed pad for enhanced thermal handling capability.

All registered trademarks and trademarks are the property of their respective owners.

## TYPICAL APPLICATION

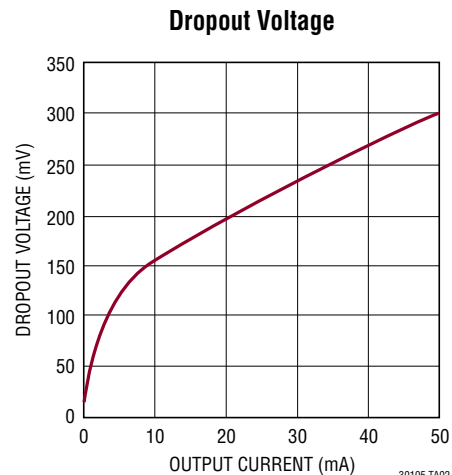
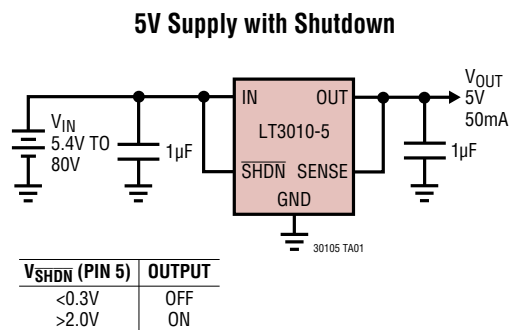

# LT3010/LT3010-5

## ABSOLUTE MAXIMUM RATINGS

(Note 1)

IN Pin Voltage .....	±80V
OUT Pin Voltage.....	±60V
IN to OUT Differential Voltage .....	±80V
ADJ Pin Voltage .....	±7V
SHDN Pin Input Voltage .....	±80V
Output Short-Circuit Duration .....	Indefinite
Storage Temperature Range .....	-65°C to 150°C
Operating Junction Temperature Range	
(Notes 3, 10, 11)	
LT3010E.....	-40°C to 125°C
LT3010H .....	-40°C to 140°C
LT3010MP .....	-55°C to 125°C
Lead Temperature (Soldering, 10 sec).....	300°C

## PIN CONFIGURATION

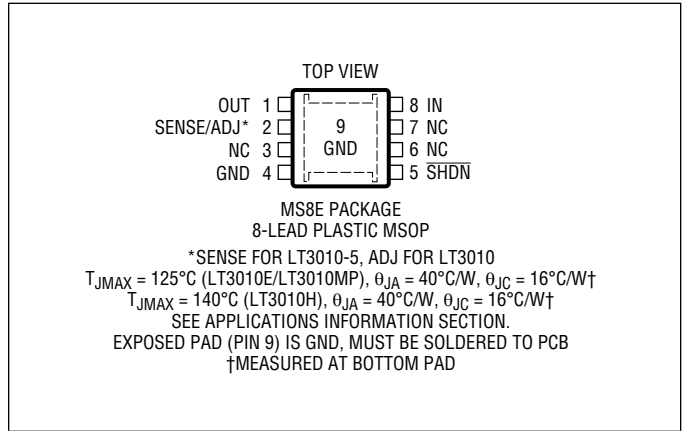

## ORDER INFORMATION

LEAD FREE FINISH	TAPE AND REEL	PART MARKING*	PACKAGE DESCRIPTION	TEMPERATURE RANGE
LT3010EMS8E#PBF	LT3010EMS8E#TRPBF	LTZF	8-Lead Plastic MSOP	-40°C to 125°C
LT3010EMS8E-5#PBF	LT3010EMS8E-5#TRPBF	LTAEF	8-Lead Plastic MSOP	-40°C to 125°C
LT3010HMS8E#PBF	LT3010HMS8E#TRPBF	LTCLP	8-Lead Plastic MSOP	-40°C to 140°C
LT3010HMS8E-5#PBF	LT3010HMS8E-5#TRPBF	LTCLQ	8-Lead Plastic MSOP	-40°C to 140°C
LT3010MPMS8E#PBF	LT3010MPMS8E#TRPBF	LTZF	8-Lead Plastic MSOP	-55°C to 125°C
LT3010MPMS8E-5#PBF	LT3010MPMS8E-5#TRPBF	LTAEF	8-Lead Plastic MSOP	-55°C to 125°C
LEAD BASED FINISH	TAPE AND REEL	PART MARKING*	PACKAGE DESCRIPTION	TEMPERATURE RANGE
LT3010EMS8E	LT3010EMS8E#TR	LTZF	8-Lead Plastic MSOP	-40°C to 125°C
LT3010EMS8E-5	LT3010EMS8E-5#TR	LTAEF	8-Lead Plastic MSOP	-40°C to 125°C
LT3010HMS8E	LT3010HMS8E #TR	LTCLP	8-Lead Plastic MSOP	-40°C to 140°C
LT3010HMS8E-5	LT3010HMS8E-5 #TR	LTCLQ	8-Lead Plastic MSOP	-40°C to 140°C
LT3010MPMS8E	LT3010MPMS8E#TR	LTZF	8-Lead Plastic MSOP	-55°C to 125°C
LT3010MPMS8E-5	LT3010MPMS8E-5#TR	LTAEF	8-Lead Plastic MSOP	-55°C to 125°C
AUTOMOTIVE PRODUCTS**				
LT3010EMS8E#WPBF	LT3010EMS8E#WTRPBF	LTZF	8-Lead Plastic MSOP	-40°C to 125°C
LT3010HMS8E#WPBF	LT3010HMS8E#WTRPBF	LTZF	8-Lead Plastic MSOP	-40°C to 140°C

Contact the factory for parts specified with wider operating temperature ranges. \*The temperature grade is identified by a label on the shipping container.

**Tape and reel specifications.** Some packages are available in 500 unit reels through designated sales channels with #TRMPBF suffix.

\*\*Versions of this part are available with controlled manufacturing to support the quality and reliability requirements of automotive applications. These models are designated with a #W suffix. Only the automotive grade products shown are available for use in automotive applications. Contact your local Analog Devices account representative for specific product ordering information and to obtain the specific Automotive Reliability reports for these models.

**ELECTRICAL CHARACTERISTICS** (LT3010E, LT3010MP) The ● denotes the specifications which apply over the  $-40^{\circ}\text{C}$  to  $125^{\circ}\text{C}$  (LT3010E) or  $-55^{\circ}\text{C}$  to  $125^{\circ}\text{C}$  (LT3010MP) operating temperature range, otherwise specifications are at  $T_A = 25^{\circ}\text{C}$ .

PARAMETER	CONDITIONS		MIN	TYP	MAX	UNITS	
Minimum Input Voltage	LT3010	$I_{LOAD} = 50\text{mA}$	●	3	4	V	
Regulated Output Voltage (Note 3)	LT3010-5	$V_{IN} = 5.5\text{V}$ , $I_{LOAD} = 1\text{mA}$ $6\text{V} < V_{IN} < 80\text{V}$ , $1\text{mA} < I_{LOAD} < 50\text{mA}$	●	4.925	5.000	5.075	V
			●	4.850	5.000	5.150	V
ADJ Pin Voltage (Notes 2, 3)	LT3010	$V_{IN} = 3\text{V}$ , $I_{LOAD} = 1\text{mA}$ $4\text{V} < V_{IN} < 80\text{V}$ , $1\text{mA} < I_{LOAD} < 50\text{mA}$	●	1.258	1.275	1.292	V
			●	1.237	1.275	1.313	V
Line Regulation	LT3010-5	$\Delta V_{IN} = 5.5\text{V}$ to $80\text{V}$ , $I_{LOAD} = 1\text{mA}$	●	3	15	mV	
	LT3010 (Note 2)	$\Delta V_{IN} = 3\text{V}$ to $80\text{V}$ , $I_{LOAD} = 1\text{mA}$		3	13	mV	
Load Regulation	LT3010-5	$V_{IN} = 6\text{V}$ , $\Delta I_{LOAD} = 1\text{mA}$ to $50\text{mA}$ $V_{IN} = 6\text{V}$ , $\Delta I_{LOAD} = 1\text{mA}$ to $50\text{mA}$	●	25	50	mV	
	LT3010 (Note 2)	$V_{IN} = 4\text{V}$ , $\Delta I_{LOAD} = 1\text{mA}$ to $50\text{mA}$ $V_{IN} = 4\text{V}$ , $\Delta I_{LOAD} = 1\text{mA}$ to $50\text{mA}$	●	10	20	mV	
Dropout Voltage $V_{IN} = V_{OUT(NOMINAL)}$ (Notes 4, 5)	$I_{LOAD} = 1\text{mA}$ $I_{LOAD} = 1\text{mA}$		●	100	150	mV	
	$I_{LOAD} = 10\text{mA}$ $I_{LOAD} = 10\text{mA}$		●	200	260	mV	
	$I_{LOAD} = 50\text{mA}$ $I_{LOAD} = 50\text{mA}$		●	300	370	mV	
GND Pin Current $V_{IN} = V_{OUT(NOMINAL)}$ (Notes 4, 6)	$I_{LOAD} = 0\text{mA}$		●	30	60	$\mu\text{A}$	
	$I_{LOAD} = 1\text{mA}$		●	100	180	$\mu\text{A}$	
	$I_{LOAD} = 10\text{mA}$		●	400	700	$\mu\text{A}$	
	$I_{LOAD} = 50\text{mA}$		●	1.8	3.3	$\text{mA}$	
Output Voltage Noise	$C_{OUT} = 10\mu\text{F}$ , $I_{LOAD} = 50\text{mA}$ , $\text{BW} = 10\text{Hz}$ to $100\text{kHz}$			100		$\mu\text{V}_{RMS}$	
ADJ Pin Bias Current	(Note 7)			50	100	nA	
Shutdown Threshold	$V_{OUT} = \text{Off to On}$ $V_{OUT} = \text{On to Off}$		●	1.3	2	V	
		●	0.3	1.1		V	
SHDN Pin Current (Note 8)	$V_{SHDN} = 0\text{V}$ $V_{SHDN} = 6\text{V}$			0.5	2	$\mu\text{A}$	
				0.1	0.5	$\mu\text{A}$	
Quiescent Current in Shutdown	$V_{IN} = 6\text{V}$ , $V_{SHDN} = 0\text{V}$			1	5	$\mu\text{A}$	
Ripple Rejection	LT3010	$V_{IN} = 7\text{V(Avg)}$ , $V_{RIPPLE} = 0.5\text{V}_{P-P}$ , $f_{RIPPLE} = 120\text{Hz}$ , $I_{LOAD} = 50\text{mA}$		65	75	dB	
	LT3010-5	$V_{IN} = 7\text{V(Avg)}$ , $V_{RIPPLE} = 0.5\text{V}_{P-P}$ , $f_{RIPPLE} = 120\text{Hz}$ , $I_{LOAD} = 50\text{mA}$		60	68	dB	
Current Limit	$V_{IN} = 7\text{V}$ , $V_{OUT} = 0\text{V}$			140		$\text{mA}$	
	LT3010-5 $V_{IN} = 6\text{V}$ , $\Delta V_{OUT} = -0.1\text{V}$	●	60			$\text{mA}$	
	LT3010 (Note 2) $V_{IN} = 4\text{V}$ , $\Delta V_{OUT} = -0.1\text{V}$	●	60			$\text{mA}$	
Input Reverse Leakage Current	$V_{IN} = -80\text{V}$ , $V_{OUT} = 0\text{V}$		●		6	$\text{mA}$	
Reverse Output Current (Note 9)	LT3010-5	$V_{OUT} = 5\text{V}$ , $V_{IN} < 5\text{V}$		10	20	$\mu\text{A}$	
	LT3010 (Note 2)	$V_{OUT} = 1.275\text{V}$ , $V_{IN} < 1.275\text{V}$		8	15	$\mu\text{A}$	

**(LT3010H)** The ● denotes the specifications which apply over the  $-40^{\circ}\text{C}$  to  $140^{\circ}\text{C}$  operating temperature range, otherwise specifications are at  $T_A = 25^{\circ}\text{C}$ .

PARAMETER	CONDITIONS		MIN	TYP	MAX	UNITS	
Minimum Input Voltage	LT3010	$I_{LOAD} = 50\text{mA}$	●	3	4.25	V	
Regulated Output Voltage (Note 3)	LT3010-5	$V_{IN} = 5.5\text{V}$ , $I_{LOAD} = 1\text{mA}$ $6\text{V} < V_{IN} < 80\text{V}$ , $1\text{mA} < I_{LOAD} < 50\text{mA}$	●	4.925	5.000	5.075	V
			●	4.825	5.000	5.15	V
ADJ Pin Voltage (Notes 2, 3)	LT3010	$V_{IN} = 3\text{V}$ , $I_{LOAD} = 1\text{mA}$ $4.25\text{V} < V_{IN} < 80\text{V}$ , $1\text{mA} < I_{LOAD} < 50\text{mA}$	●	1.258	1.275	1.292	V
			●	1.230	1.275	1.313	V
Line Regulation	LT3010-5	$\Delta V_{IN} = 5.5\text{V}$ to $80\text{V}$ , $I_{LOAD} = 1\text{mA}$	●	3	20	mV	
	LT3010 (Note 2)	$\Delta V_{IN} = 3\text{V}$ to $80\text{V}$ , $I_{LOAD} = 1\text{mA}$	●	3	15	mV	

# LT3010/LT3010-5

## ELECTRICAL CHARACTERISTICS (LT3010H) The ● denotes the specifications which apply over the –40°C to 140°C operating temperature range, otherwise specifications are at T<sub>A</sub> = 25°C.

PARAMETER	CONDITIONS	MIN	TYP	MAX	UNITS
Load Regulation	LT3010-5 $V_{IN} = 6V, \Delta I_{LOAD} = 1mA \text{ to } 50mA$ $V_{IN} = 6V, \Delta I_{LOAD} = 1mA \text{ to } 50mA$		25	50 100	mV mV
	LT3010 (Note 2) $V_{IN} = 4V, \Delta I_{LOAD} = 1mA \text{ to } 50mA$ $V_{IN} = 4.25V, \Delta I_{LOAD} = 1mA \text{ to } 50mA$		10	20 45	mV mV
Dropout Voltage $V_{IN} = V_{OUT(NOMINAL)}$ (Notes 4, 5)	$I_{LOAD} = 1mA$ $I_{LOAD} = 1mA$		100	150 220	mV mV
	$I_{LOAD} = 10mA$ $I_{LOAD} = 10mA$		200	260 380	mV mV
	$I_{LOAD} = 50mA$ $I_{LOAD} = 50mA$		300	370 600	mV mV
GND Pin Current $V_{IN} = V_{OUT(NOMINAL)}$ (Notes 4, 6)	$I_{LOAD} = 0mA$	●	30	80	μA
	$I_{LOAD} = 1mA$	●	100	200	μA
	$I_{LOAD} = 10mA$	●	400	750	μA
	$I_{LOAD} = 50mA$	●	1.8	3.5	mA
Output Voltage Noise	$C_{OUT} = 10\mu F, I_{LOAD} = 250mA, BW = 10Hz \text{ to } 100kHz$		100		μV <sub>RMS</sub>
ADJ Pin Bias Current	(Note 7)		50	100	nA
Shutdown Threshold	$V_{OUT} = \text{Off to On}$	●	1.3	2	V
	$V_{OUT} = \text{On to Off}$	●	0.3	0.8	V
$\overline{SHDN}$ Pin Current (Note 8)	$V_{\overline{SHDN}} = 0V$		0.5	2	μA
	$V_{\overline{SHDN}} = 6V$		0.1	0.5	μA
Quiescent Current in Shutdown	$V_{IN} = 6V, V_{\overline{SHDN}} = 0V$		1	5	μA
Ripple Rejection	LT3010 $V_{IN} = 7V(Avg), V_{RIPPLE} = 0.5V_{P-P}, f_{RIPPLE} = 120Hz, I_{LOAD} = 50mA$		65	75	dB
	LT3010-5 $V_{IN} = 7V(Avg), V_{RIPPLE} = 0.5V_{P-P}, f_{RIPPLE} = 120Hz, I_{LOAD} = 50mA$		60	68	dB
Current Limit	$V_{IN} = 7V, V_{OUT} = 0V$	●		140	mA
	LT3010-5 $V_{IN} = 6V, \Delta V_{OUT} = -0.1V$	●	55		mA
	LT3010 (Note 2) $V_{IN} = 4.25V, \Delta V_{OUT} = -0.1V$	●	55		mA
Input Reverse Leakage Current	$V_{IN} = -80V, V_{OUT} = 0V$	●		6	mA
Reverse Output Current (Note 9)	LT3010-5 $V_{OUT} = 5V, V_{IN} < 5V$		10	20	μA
	LT3010 (Note 2) $V_{OUT} = 1.275V, V_{IN} < 1.275V$		8	15	μA

**Note 1:** Stresses beyond those listed under Absolute Maximum Ratings may cause permanent damage to the device. Exposure to any Absolute Maximum Rating condition for extended periods may affect device reliability and lifetime.

**Note 2:** The LT3010 (adjustable version) is tested and specified for these conditions with the ADJ pin connected to the OUT pin.

**Note 3:** Operating conditions are limited by maximum junction temperature. The regulated output voltage specification will not apply for all possible combinations of input voltage and output current. When operating at maximum input voltage, the output current range must be limited. When operating at maximum output current, the input voltage range must be limited.

**Note 4:** To satisfy requirements for minimum input voltage, the LT3010 (adjustable version) is tested and specified for these conditions with an external resistor divider (249k bottom, 392k top) for an output voltage of 3.3V. The external resistor divider will add a 5μA DC load on the output.

**Note 5:** Dropout voltage is the minimum input to output voltage differential needed to maintain regulation at a specified output current. In dropout, the output voltage will be equal to  $(V_{IN} - V_{DROPOUT})$ .

**Note 6:** GND pin current is tested with  $V_{IN} = V_{OUT}$  (nominal) and a current source load. This means the device is tested while operating in its dropout

region. This is the worst-case GND pin current. The GND pin current will decrease slightly at higher input voltages.

**Note 7:** ADJ pin bias current flows into the ADJ pin.

**Note 8:**  $\overline{SHDN}$  pin current flows out of the  $\overline{SHDN}$  pin.

**Note 9:** Reverse output current is tested with the IN pin grounded and the OUT pin forced to the rated output voltage. This current flows into the OUT pin and out the GND pin.

**Note 10:** The LT3010E is guaranteed to meet performance specifications from 0°C to 125°C operating junction temperature. Specifications over the –40°C to 125°C operating junction temperature range are assured by design, characterization and correlation with statistical process controls. The LT3010H is tested to the LT3010H Electrical Characteristics table at 140°C operating junction temperature. The LT3010MP is 100% tested and guaranteed over the –55°C to 125°C operating junction temperature range. High junction temperatures degrade operating lifetimes. Operating lifetime is derated at junction temperatures greater than 125°C.

**Note 11:** This IC includes overtemperature protection that is intended to protect the device during momentary overload conditions. Junction temperature will exceed 125°C (LT3010E and LT3010MP) or 140°C (LT3010H) when overtemperature protection is active. Continuous operation above the specified maximum operating junction temperature may impair device reliability.

# TYPICAL PERFORMANCE CHARACTERISTICS

**Typical Dropout Voltage**

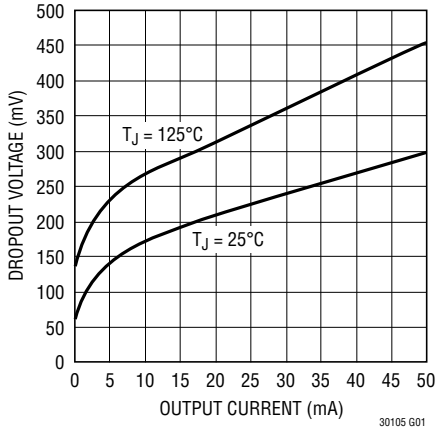

**Guaranteed Dropout Voltage**

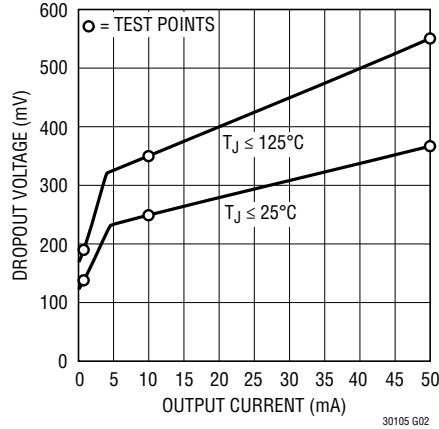

**Dropout Voltage**

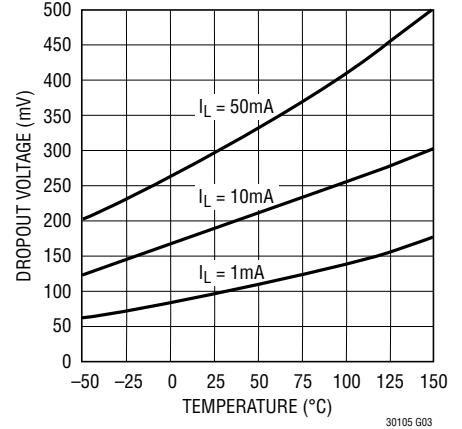

**Quiescent Current**

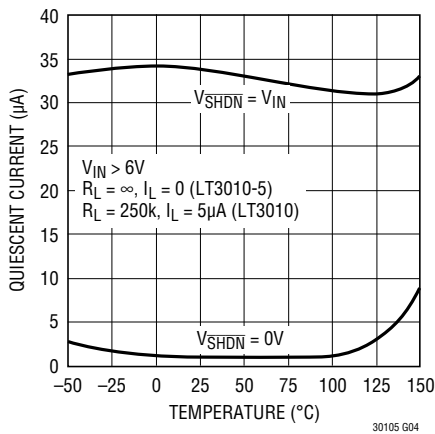

**LT3010 ADJ Pin Voltage**

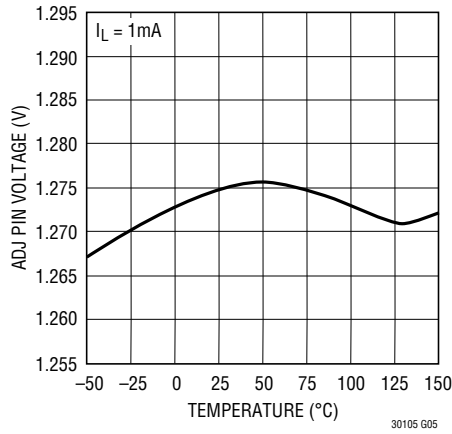

**LT3010-5 Output Voltage**

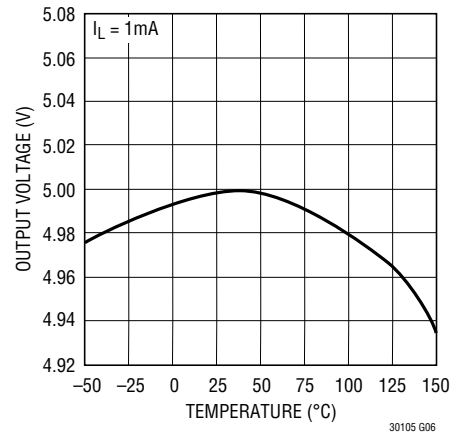

**LT3010 Quiescent Current**

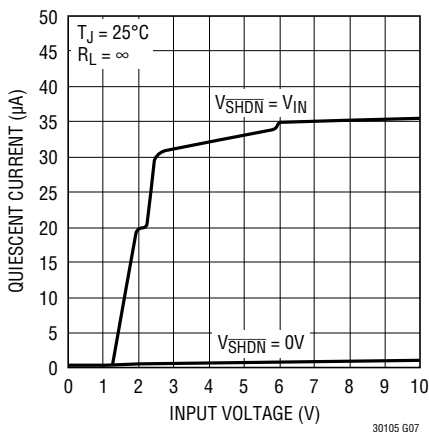

**LT3010-5 Quiescent Current**

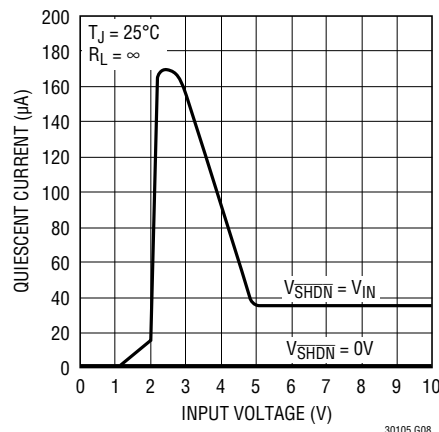

**LT3010 GND Pin Current**

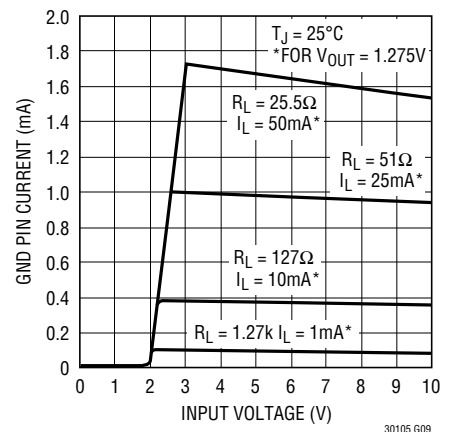

## TYPICAL PERFORMANCE CHARACTERISTICS

### LT3010-5 GND Pin Current

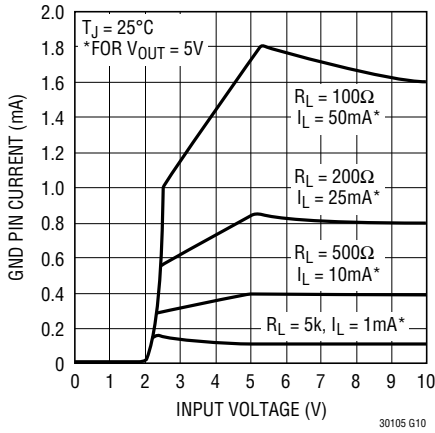

### GND Pin Current vs I<sub>LOAD</sub>

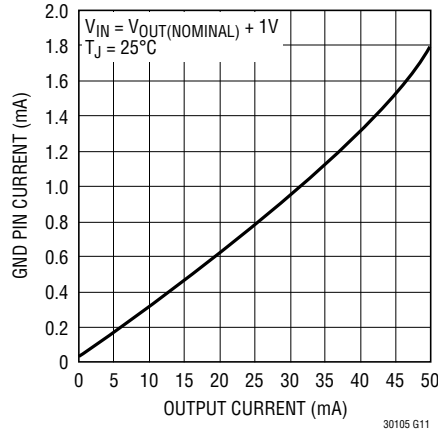

### SHDN Pin Threshold

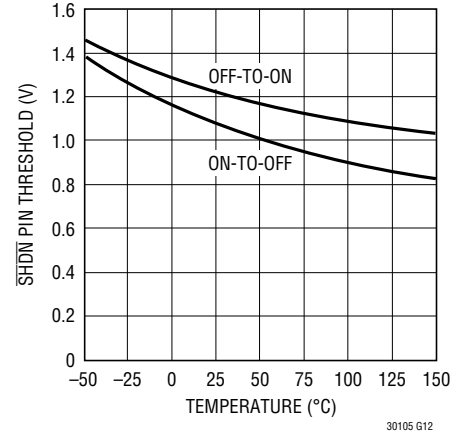

### SHDN Pin Current

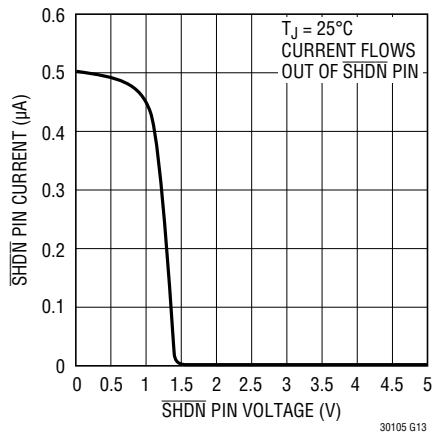

### SHDN Pin Current

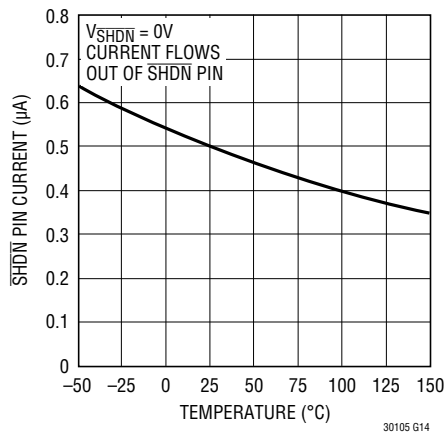

### ADJ Pin Bias Current

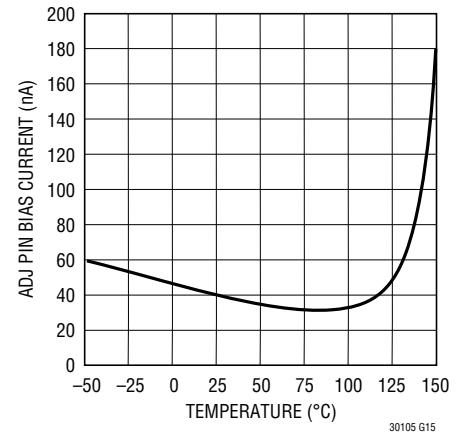

### Current Limit

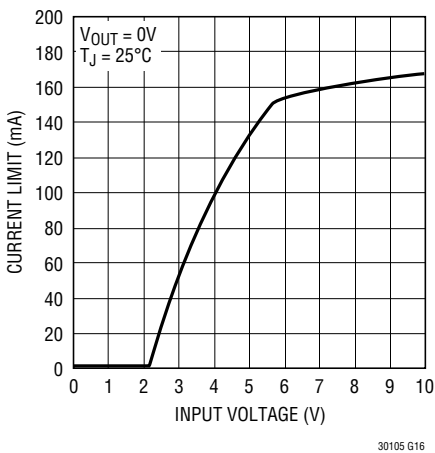

### Current Limit

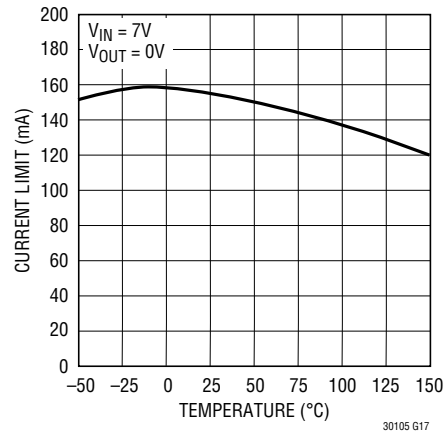

### Reverse Output Current

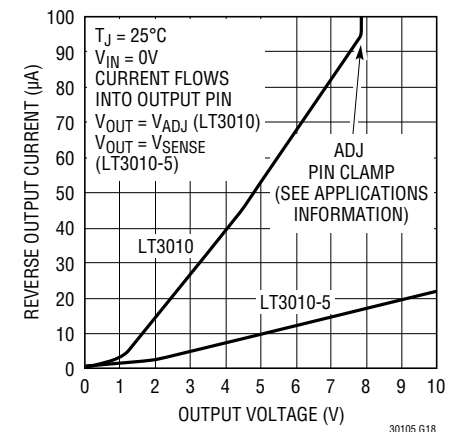

# TYPICAL PERFORMANCE CHARACTERISTICS

**Reverse Output Current**

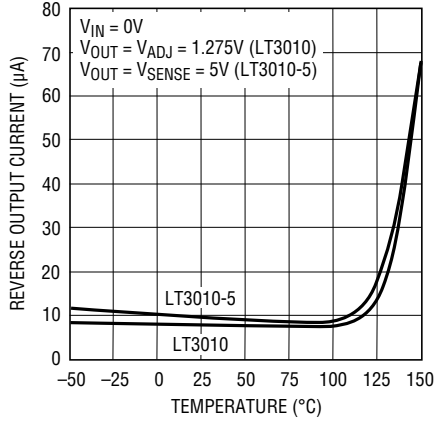

3010 G19

**Input Ripple Rejection**

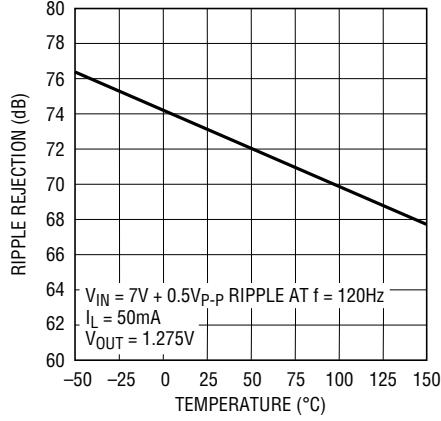

30105 G20

**Input Ripple Rejection**

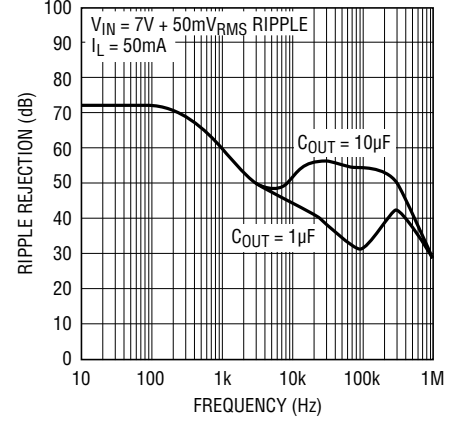

30105 G21

**LT3010 Minimum Input Voltage**

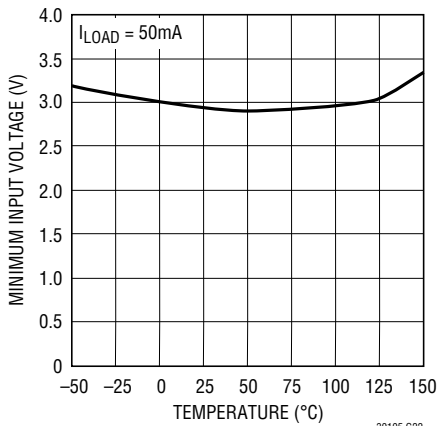

30105 G22

**Load Regulation**

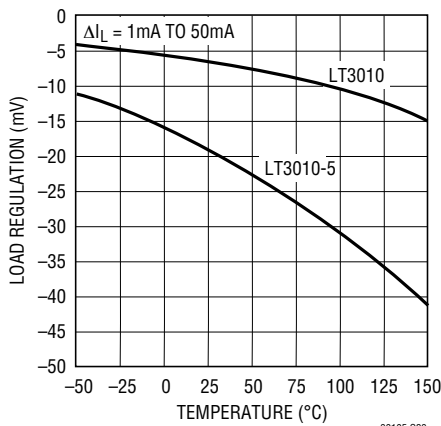

30105 G23

**Output Noise Spectral Density**

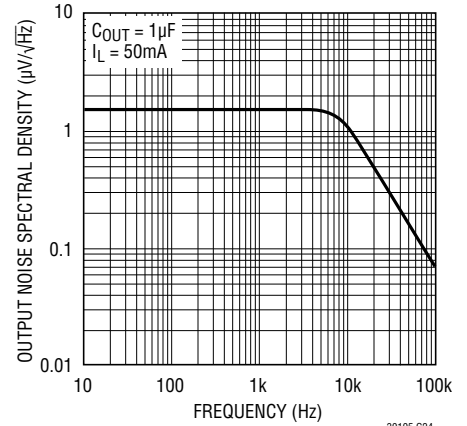

30105 G24

**LT3010-5 10Hz to 100kHz Output Noise**

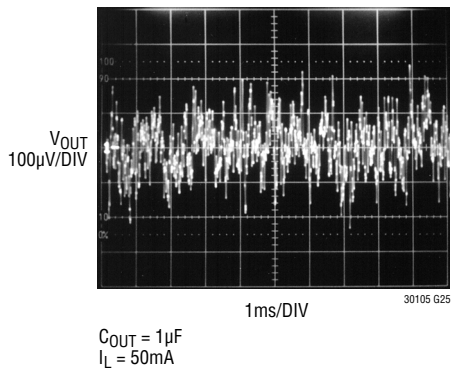

30105 G25

**LT3010-5 Transient Response**

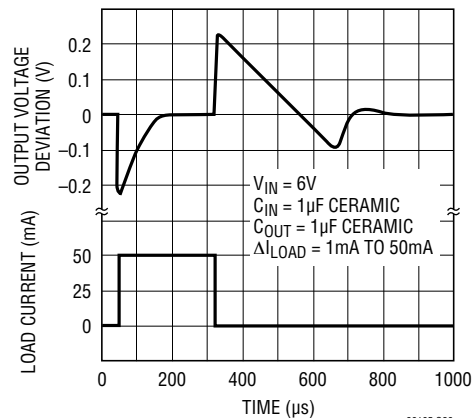

30105 G26

## PIN FUNCTIONS

**OUT (Pin 1):** Output. The output supplies power to the load. A minimum output capacitor of 1 $\mu$ F is required to prevent oscillations. Larger output capacitors will be required for applications with large transient loads to limit peak voltage transients. See the Applications Information section for more information on output capacitance and reverse output characteristics.

**SENSE (Pin 2):** Sense. For the LT3010-5, the SENSE pin is the input to the error amplifier. Optimum regulation will be obtained at the point where the SENSE pin is connected to the OUT pin of the regulator. In critical applications, small voltage drops are caused by the resistance ( $R_P$ ) of PC traces between the regulator and the load. These may be eliminated by connecting the SENSE pin to the output at the load as shown in Figure 1 (Kelvin Sense Connection). Note that the voltage drop across the external PC traces will add to the dropout voltage of the regulator. The SENSE pin bias current is 10 $\mu$ A at the nominal rated output voltage.

**ADJ (Pin 2):** Adjust. For the adjustable LT3010, this is the input to the error amplifier. This pin is internally clamped to  $\pm 7V$ . It has a bias current of 50nA which flows into the pin (see curve of ADJ Pin Bias Current vs Temperature

in the Typical Performance Characteristics). The ADJ pin voltage is 1.275V referenced to ground, and the output voltage range is 1.275V to 60V.

**NC (Pins 3, 6, 7):** No Connection. May be floated, tied to IN or tied to GND.

**GND (Pin 4, Pin 9):** Ground. The exposed backside (pin 9) of the package is an electrical connection for GND. As such, to ensure optimum device operation, pin 9 must be connected directly to pin 4 on the PC board.

**SHDN (Pin 5):** Shutdown. The  $\overline{\text{SHDN}}$  pin is used to put the LT3010 into a low power shutdown state. The output will be off when the  $\overline{\text{SHDN}}$  pin is pulled low. The  $\overline{\text{SHDN}}$  pin can be driven either by 5V logic or open-collector logic with a pull-up resistor. The pull-up resistor is only required to supply the pull-up current of the open-collector gate, normally several microamperes. If unused, the  $\overline{\text{SHDN}}$  pin must be tied to a logic high or  $V_{IN}$ .

**IN (Pin 8):** Input. Power is supplied to the device through the IN pin. A bypass capacitor is required on this pin if the device is more than six inches away from the main input filter capacitor. In general, the output impedance of a battery rises with frequency, so it is advisable to include a bypass capacitor in battery-powered circuits. A bypass capacitor in the range of 1 $\mu$ F to 10 $\mu$ F is sufficient. The LT3010 is designed to withstand reverse voltages on the IN pin with respect to ground and the OUT pin. In the case of a reversed input, which can happen if a battery is plugged in backwards, the LT3010 will act as if there is a diode in series with its input. There will be no reverse current flow into the LT3010 and no reverse voltage will appear at the load. The device will protect both itself and the load.

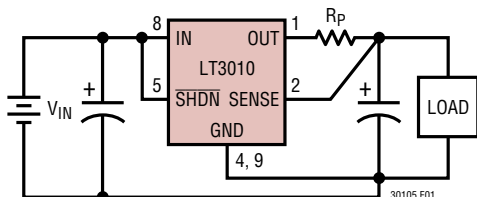

Figure 1. Kelvin Sense Connection



## APPLICATIONS INFORMATION

The LT3010 is a 50mA high voltage low dropout regulator with micropower quiescent current and shutdown. The device is capable of supplying 50mA at a dropout voltage of 300mV. The low operating quiescent current (30µA) drops to 1µA in shutdown. In addition to the low quiescent current, the LT3010 incorporates several protection features which make it ideal for use in battery-powered systems. The device is protected against both reverse input and reverse output voltages. In battery backup applications where the output can be held up by a backup battery when the input is pulled to ground, the LT3010 acts like it has a diode in series with its output and prevents reverse current flow.

### Adjustable Operation

The adjustable version of the LT3010 has an output voltage range of 1.275V to 60V. The output voltage is set by the ratio of two external resistors as shown in Figure 2. The device servos the output to maintain the voltage at the adjust pin at 1.275V referenced to ground. The current in R1 is then equal to 1.275V/R1 and the current in R2 is the current in R1 plus the ADJ pin bias current. The ADJ pin bias current, 50nA at 25°C, flows through R2 into the ADJ pin. The output voltage can be calculated using the formula in Figure 2. The value of R1 should be less than 250k to minimize errors in the output voltage caused by the ADJ pin bias current. Note that in shutdown the output is turned off and the divider current will be zero.

A small capacitor (C1) placed in parallel with the top resistor (R2) of the output divider is necessary for stability and transient performance of the adjustable LT3010. The impedance of C1 at 10kHz should be less than the value of R1.

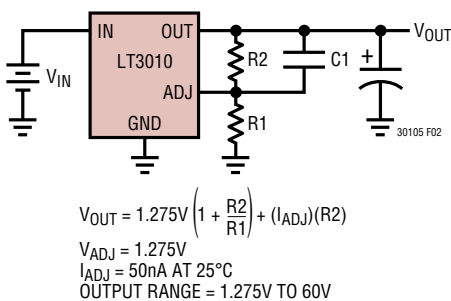

Figure 2. Adjustable Operation

The adjustable device is tested and specified with the ADJ pin tied to the OUT pin and a 5µA DC load (unless otherwise specified) for an output voltage of 1.275V. Specifications for output voltages greater than 1.275V will be proportional to the ratio of the desired output voltage to 1.275V; ( $V_{OUT}/1.275V$ ). For example, load regulation for an output current change of 1mA to 50mA is -10mV typical at  $V_{OUT} = 1.275V$ . At  $V_{OUT} = 12V$ , load regulation is:

$$(12V/1.275V) \cdot (-10mV) = -94mV$$

### Output Capacitance and Transient Response

The LT3010 is designed to be stable with a wide range of output capacitors. The ESR of the output capacitor affects stability, most notably with small capacitors. A minimum output capacitor of 1µF with an ESR of 3Ω or less is recommended to prevent oscillations. The LT3010 is a micropower device and output transient response will be a function of output capacitance. Larger values of output capacitance decrease the peak deviations and provide improved transient response for larger load current changes. Bypass capacitors, used to decouple individual components powered by the LT3010, will increase the effective output capacitor value.

Extra consideration must be given to the use of ceramic capacitors. Ceramic capacitors are manufactured with a variety of dielectrics, each with different behavior across temperature and applied voltage. The most common dielectrics used are specified with EIA temperature characteristic codes of Z5U, Y5V, X5R and X7R. The Z5U and Y5V dielectrics are good for providing high capacitances in a small package, but they tend to have strong voltage and temperature coefficients as shown in Figure 3 and Figure 4. When used with a 5V regulator, a 16V 10µF Y5V capacitor can exhibit an effective value as low as 1µF to 2µF for the DC bias voltage applied and over the operating temperature range. The X5R and X7R dielectrics result in more stable characteristics and are more suitable for use as the output capacitor. The X7R type has better stability across temperature, while the X5R is less expensive and is available in higher values. Care still must be exercised when using X5R and X7R capacitors; the X5R and X7R codes only specify operating temperature range and maximum capacitance change over temperature. Capacitance

## APPLICATIONS INFORMATION

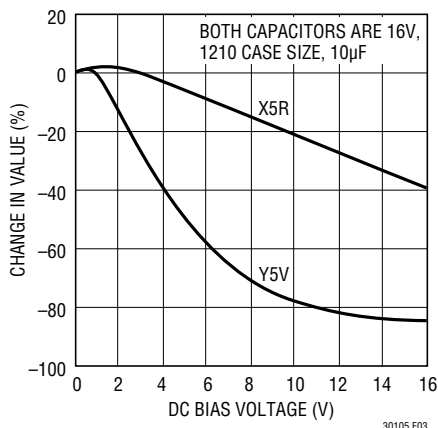

**Figure 3. Ceramic Capacitor DC Bias Characteristics**

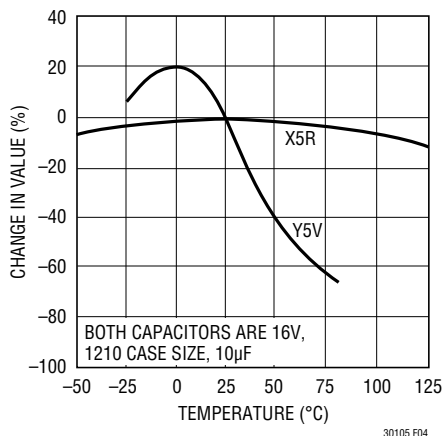

**Figure 4. Ceramic Capacitor Temperature Characteristics**

change due to DC bias with X5R and X7R capacitors is better than Y5V and Z5U capacitors, but can still be significant enough to drop capacitor values below appropriate levels. Capacitor DC bias characteristics tend to improve as component case size increases, but expected capacitance at operating voltage should be verified.

Voltage and temperature coefficients are not the only sources of problems. Some ceramic capacitors have a piezoelectric response. A piezoelectric device generates voltage across its terminals due to mechanical stress, similar to the way a piezoelectric accelerometer or microphone works. For a ceramic capacitor the stress can be induced by vibrations in the system or thermal transients.

### Thermal Considerations

The power handling capability of the device will be limited by the maximum rated junction temperature (125°C, LT3010E/LT3010MP or 140°C, LT3010H). The power dissipated by the device will be made up of two components:

1. Output current multiplied by the input/output voltage differential:  $I_{OUT} \cdot (V_{IN} - V_{OUT})$  and,
2. GND pin current multiplied by the input voltage:  $I_{GND} \cdot V_{IN}$

The GND pin current can be found by examining the GND Pin Current curves in the Typical Performance Characteristics. Power dissipation will be equal to the sum of the two components listed above.

The LT3010 series regulators have internal thermal limiting designed to protect the device during overload conditions. For continuous normal conditions the maximum junction temperature rating of 125°C (LT3010E/LT3010MP) or 140°C (LT3010H) must not be exceeded. It is important to give careful consideration to all sources of thermal resistance from junction to ambient. Additional heat sources mounted nearby must also be considered.

For surface mount devices, heat sinking is accomplished by using the heat spreading capabilities of the PC board and its copper traces. Copper board stiffeners and plated through-holes can also be used to spread the heat generated by power devices.

The following table lists thermal resistance for several different board sizes and copper areas. All measurements were taken in still air on 3/32" FR-4 board with one ounce copper.

**Table 1. Measured Thermal Resistance**

COPPER AREA		BOARD AREA	THERMAL RESISTANCE (JUNCTION-TO-AMBIENT)
TOPSIDE	BACKSIDE		
2500 sq mm	2500 sq mm	2500 sq mm	40°C/W
1000 sq mm	2500 sq mm	2500 sq mm	45°C/W
225 sq mm	2500 sq mm	2500 sq mm	50°C/W
100 sq mm	2500 sq mm	2500 sq mm	62°C/W

## APPLICATIONS INFORMATION

The thermal resistance junction-to-case ( $\theta_{JC}$ ), measured at the exposed pad on the back of the die, is 16°C/W.

Continuous operation at large input/output voltage differentials and maximum load current is not practical due to thermal limitations. Transient operation at high input/output differentials is possible. The approximate thermal time constant for a 2500sq mm 3/32" FR-4 board with maximum topside and backside area for one ounce copper is 3 seconds. This time constant will increase as more thermal mass is added (i.e. vias, larger board, and other components).

For an application with transient high power peaks, average power dissipation can be used for junction temperature calculations as long as the pulse period is significantly less than the thermal time constant of the device and board.

### Calculating Junction Temperature

Example 1: Given an output voltage of 5V, an input voltage range of 24V to 30V, an output current range of 0mA to 50mA, and a maximum ambient temperature of 50°C, what will the maximum junction temperature be?

The power dissipated by the device will be equal to:

$$I_{OUT(MAX)} \cdot (V_{IN(MAX)} - V_{OUT}) + (I_{GND} \cdot V_{IN(MAX)})$$

where:

$$I_{OUT(MAX)} = 50\text{mA}$$

$$V_{IN(MAX)} = 30\text{V}$$

$$I_{GND} \text{ at } (I_{OUT} = 50\text{mA}, V_{IN} = 30\text{V}) = 1\text{mA}$$

So:

$$P = 50\text{mA} \cdot (30\text{V} - 5\text{V}) + (1\text{mA} \cdot 30\text{V}) = 1.28\text{W}$$

The thermal resistance will be in the range of 40°C/W to 62°C/W depending on the copper area. So the junction temperature rise above ambient will be approximately equal to:

$$1.31\text{W} \cdot 50^\circ\text{C/W} = 65.5^\circ\text{C}$$

The maximum junction temperature will then be equal to the maximum junction temperature rise above ambient plus the maximum ambient temperature or:

$$T_{JMAX} = 50^\circ\text{C} + 65.5^\circ\text{C} = 115.5^\circ\text{C}$$

Example 2: Given an output voltage of 5V, an input voltage of 48V that rises to 72V for 5ms(max) out of every 100ms, and a 5mA load that steps to 50mA for 50ms out of every 250ms, what is the junction temperature rise above ambient? Using a 500ms period (well under the time constant of the board), power dissipation is as follows:

$$P1(48\text{V in, 5mA load}) = 5\text{mA} \cdot (48\text{V} - 5\text{V}) + (200\mu\text{A} \cdot 48\text{V}) = 0.23\text{W}$$

$$P2(48\text{V in, 50mA load}) = 50\text{mA} \cdot (48\text{V} - 5\text{V}) + (1\text{mA} \cdot 48\text{V}) = 2.20\text{W}$$

$$P3(72\text{V in, 5mA load}) = 5\text{mA} \cdot (72\text{V} - 5\text{V}) + (200\mu\text{A} \cdot 72\text{V}) = 0.35\text{W}$$

$$P4(72\text{V in, 50mA load}) = 50\text{mA} \cdot (72\text{V} - 5\text{V}) + (1\text{mA} \cdot 72\text{V}) = 3.42\text{W}$$

Operation at the different power levels is as follows:

76% operation at P1, 19% for P2, 4% for P3, and 1% for P4.

$$P_{EFF} = 76\%(0.23\text{W}) + 19\%(2.20\text{W}) + 4\%(0.35\text{W}) + 1\%(3.42\text{W}) = 0.64\text{W}$$

With a thermal resistance in the range of 40°C/W to 62°C/W, this translates to a junction temperature rise above ambient of 26°C to 38°C.

### High Temperature Operation

Care must be taken when designing LT3010H applications to operate at high ambient temperatures. The LT3010H works at elevated temperatures but erratic operation can occur due to unforeseen variations in external components. Some tantalum capacitors are available for high temperature operation, but ESR is often several ohms; capacitor ESR above 3Ω is unsuitable for use with the

## APPLICATIONS INFORMATION

LT3010H. Ceramic capacitor manufacturers (Murata, AVX, TDK, and Vishay Vitramon at this writing) now offer ceramic capacitors that are rated to 150°C using an X8R dielectric. Device instability will occur if output capacitor value and ESR are outside design limits at elevated temperature and operating DC voltage bias (see information on capacitor characteristics under Output Capacitance and Transient Response). Check each passive component for absolute value and voltage ratings over the operating temperature range.

Leakages in capacitors or from solder flux left after insufficient board cleaning adversely affects low quiescent current operation. Consider junction temperature increase due to power dissipation in both the junction and nearby components to ensure maximum specifications are not violated for the LT3010H or external components.

### Protection Features

The LT3010 incorporates several protection features which make it ideal for use in battery-powered circuits. In addition to the normal protection features associated with monolithic regulators, such as current limiting and thermal limiting, the device is protected against reverse-input voltages, and reverse voltages from output to input.

Current limit protection and thermal overload protection are intended to protect the device against current overload conditions at the output of the device. For normal operation, the junction temperature should not exceed 125°C (LT3010E/LT3010MP) or 140°C (LT3010H).

The input of the device will withstand reverse voltages of 80V. Current flow into the device will be limited to less than 6mA (typically less than 100 $\mu$ A) and no negative voltage will appear at the output. The device will protect both itself and the load. This provides protection against batteries which can be plugged in backward.

The ADJ pin of the adjustable device can be pulled above or below ground by as much as 7V without damaging the device. If the input is left open circuit or grounded, the ADJ pin will act like an open circuit when pulled below ground, and like a large resistor (typically 100k) in series with a diode when pulled above ground. If the input is powered by a voltage source, pulling the ADJ pin below the reference voltage will cause the device to try and force the current limit current out of the output. This will cause the output to go to an unregulated high voltage. Pulling the ADJ pin above the reference voltage will turn off all output current.

In situations where the ADJ pin is connected to a resistor divider that would pull the ADJ pin above its 7V clamp voltage if the output is pulled high, the ADJ pin input current must be limited to less than 5mA. For example, a resistor divider is used to provide a regulated 1.5V output from the 1.22V reference when the output is forced to 60V. The top resistor of the resistor divider must be chosen to limit the current into the ADJ pin to less than 5mA when the ADJ pin is at 7V. The 53V difference between the OUT and ADJ pins divided by the 5mA maximum current into the ADJ pin yields a minimum top resistor value of 10.6k.

## APPLICATIONS INFORMATION

In circuits where a backup battery is required, several different input/output conditions can occur. The output voltage may be held up while the input is either pulled to ground, pulled to some intermediate voltage, or is left open circuit. Current flow back into the output will follow the curve shown in Figure 5. The rise in reverse output current above 7V occurs from the breakdown of the 7V clamp on the ADJ pin. With a resistor divider on the regulator output, this current will be reduced depending on the size of the resistor divider.

When the IN pin of the LT3010 is forced below the OUT pin or the OUT pin is pulled above the IN pin, input current will typically drop to less than 2μA. This can happen if the input of the LT3010 is connected to a discharged (low voltage) battery and the output is held up by either a backup battery or a second regulator circuit. The state of the SHDN pin will have no effect on the reverse output current when the output is pulled above the input.

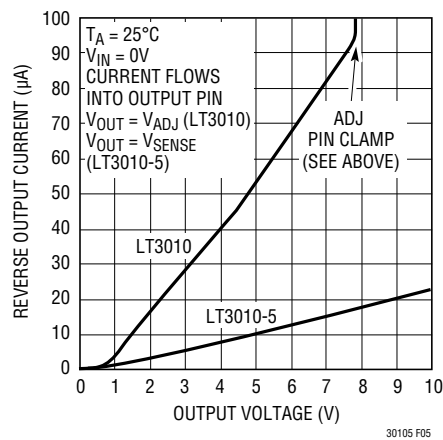
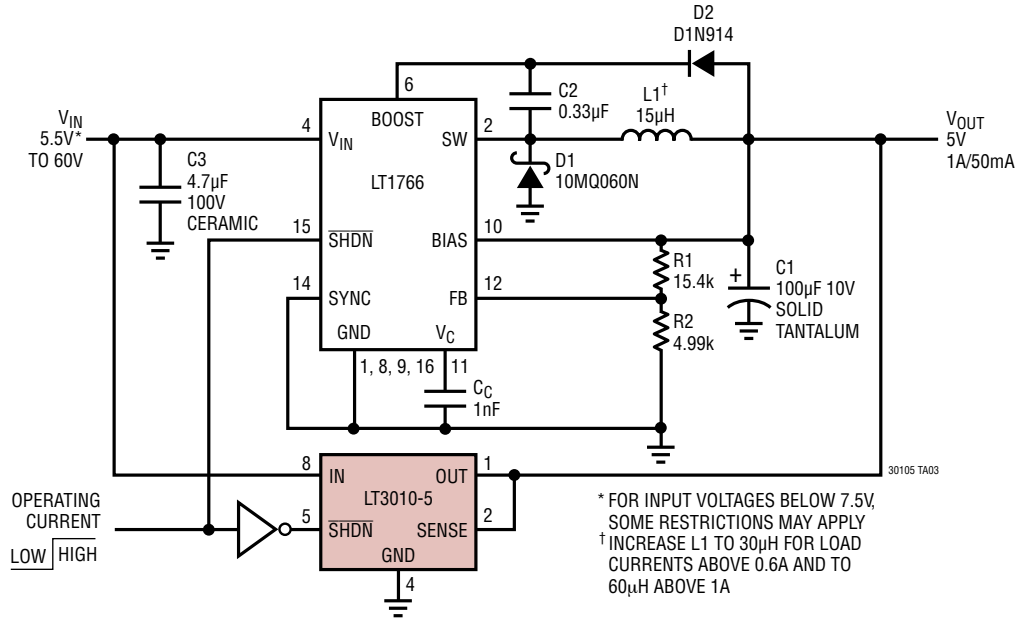

Figure 5. Reverse Output Current

## TYPICAL APPLICATIONS

### 5V Buck Converter with Low Current Keep Alive Backup



### Buck Converter Efficiency vs Load Current

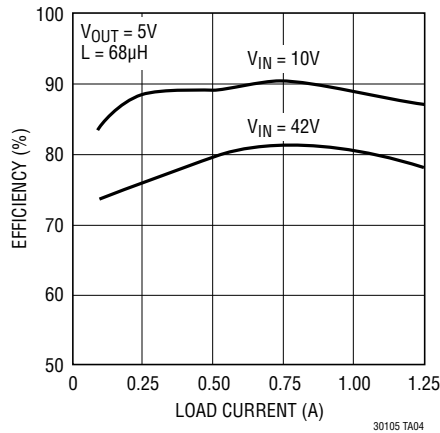

TYPICAL APPLICATIONS

LT3010 Telecom Application

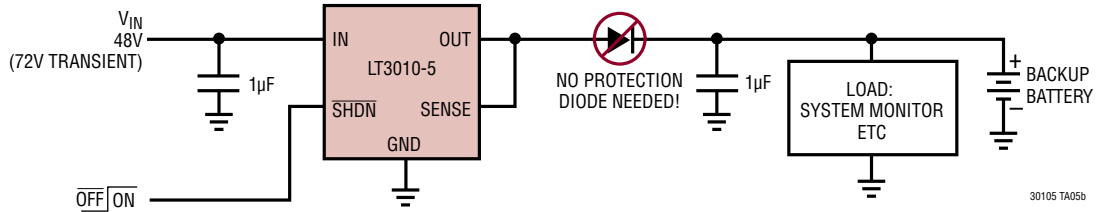

Constant Brightness for Indicator LED over Wide Input Voltage Range

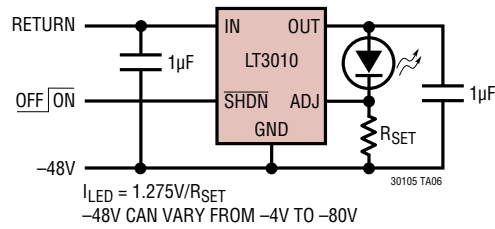

## PACKAGE DESCRIPTION

### MS8E Package 8-Lead Plastic MSOP, Exposed Die Pad (Reference LTC DWG # 05-08-1662 Rev K)

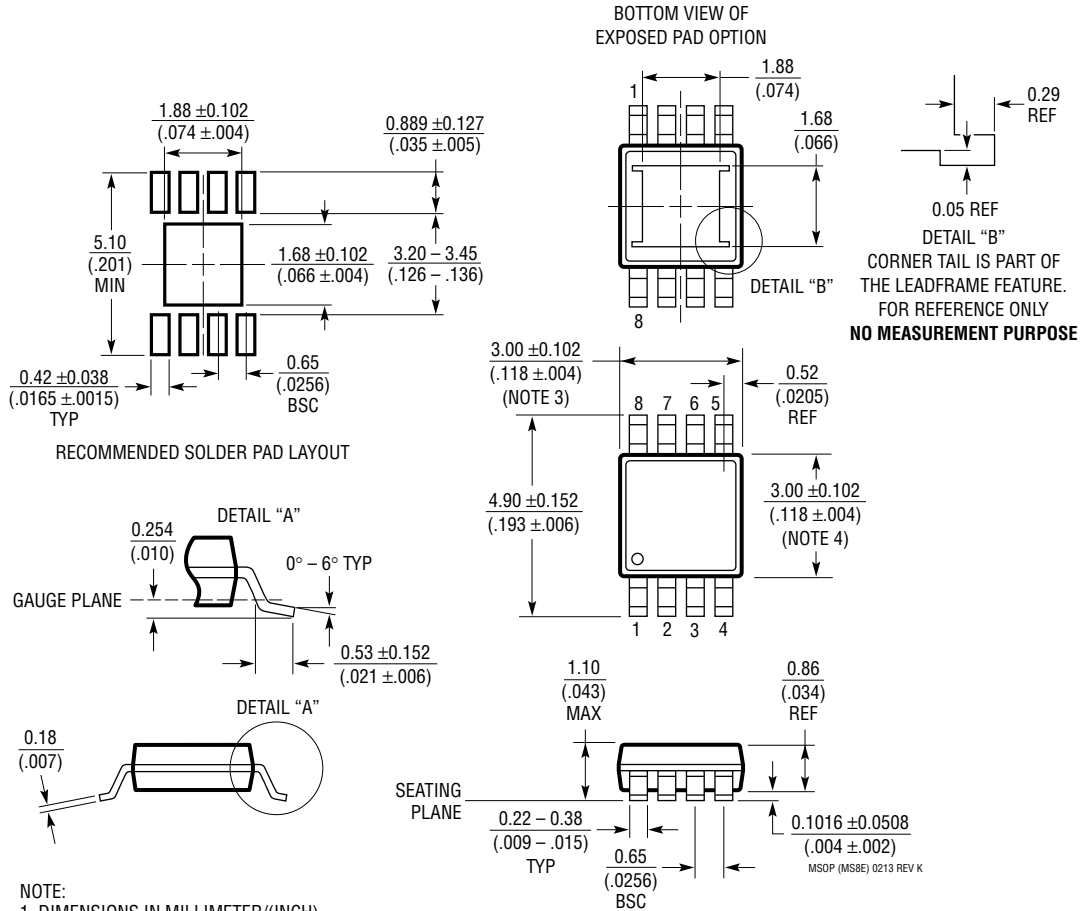

**NOTE:**

1. DIMENSIONS IN MILLIMETER/(INCH)
2. DRAWING NOT TO SCALE
3. DIMENSION DOES NOT INCLUDE MOLD FLASH, PROTRUSIONS OR GATE BURRS.  
MOLD FLASH, PROTRUSIONS OR GATE BURRS SHALL NOT EXCEED 0.152mm (.006") PER SIDE
4. DIMENSION DOES NOT INCLUDE INTERLEAD FLASH OR PROTRUSIONS.  
INTERLEAD FLASH OR PROTRUSIONS SHALL NOT EXCEED 0.152mm (.006") PER SIDE
5. LEAD COPLANARITY (BOTTOM OF LEADS AFTER FORMING) SHALL BE 0.102mm (.004") MAX
6. EXPOSED PAD DIMENSION DOES INCLUDE MOLD FLASH. MOLD FLASH ON E-PAD SHALL NOT EXCEED 0.254mm (.010") PER SIDE.



**REVISION HISTORY** (Revision history begins at Rev D)

REV	DATE	DESCRIPTION	PAGE NUMBER
D	05/10	Added MP-Grade to all sections. Updated Related Parts list.	2 to 4, 10, 12 18
E	04/11	Update MSOP package drawing.	16
F	02/21	Added AEC-Q100 Qual complete statement. Added AEC-Q100 part numbers.	1 2

## TYPICAL APPLICATION

LT3010 Automotive Application

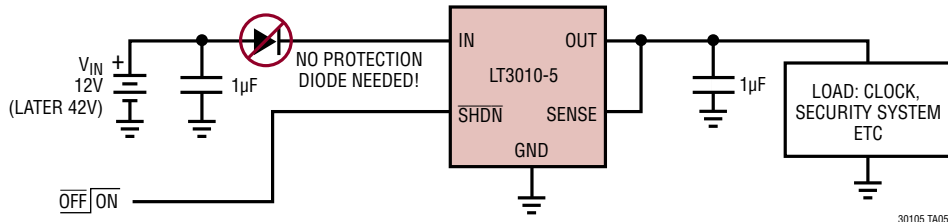

## RELATED PARTS

PART NUMBER	DESCRIPTION	COMMENTS
LT1676	60V, 440mA ( $I_{OUT}$ ), 100kHz, High Efficiency Step-Down DC/DC Converter	$V_{IN}$ : 7.4V to 60V, $V_{OUT}$ = 1.24V, $I_Q$ = 3.2mA, $I_{SD}$ = 2.5µA, S8 Package
LT1761	100mA, Low Noise Micropower, LDO	$V_{IN}$ : 1.8V to 20V, $V_{OUT}$ = 1.22V, $V_{DO}$ = 0.3V, $I_Q$ = 20µA, $I_{SD}$ = <1µA, Low Noise < 20µV <sub>RMS</sub> , Stable with 1µF Ceramic Capacitors, ThinSOT™ Package
LT1762	150mA, Low Noise Micropower, LDO	$V_{IN}$ : 1.8V to 20V, $V_{OUT}$ = 1.22V, $V_{DO}$ = 0.3V, $I_Q$ = 25µA, $I_{SD}$ = <1µA, Low Noise < 20µV <sub>RMS</sub> , MS8 Package
LT1763	500mA, Low Noise Micropower, LDO	$V_{IN}$ : 1.8V to 20V, $V_{OUT}$ = 1.22V, $V_{DO}$ = 0.3V, $I_Q$ = 30µA, $I_{SD}$ = <1µA, Low Noise < 20µV <sub>RMS</sub> , S8 Package
LT1766	60V, 1.2A ( $I_{OUT}$ ), 200kHz, High Efficiency Step-Down DC/DC Converter	$V_{IN}$ : 5.5V to 60V, $V_{OUT}$ = 1.20V, $I_Q$ = 2.5mA, $I_{SD}$ = 25µA, TSSOP16/E Package
LT1776	40V, 550mA ( $I_{OUT}$ ), 200kHz, High Efficiency Step-Down DC/DC Converter	$V_{IN}$ : 7.4V to 40V, $V_{OUT}$ = 1.24V, $I_Q$ = 3.2mA, $I_{SD}$ = 30µA, N8, S8 Packages
LT1956	60V, 1.2A ( $I_{OUT}$ ), 500kHz, High Efficiency Step-Down DC/DC Converter	$V_{IN}$ : 5.5V to 60V, $V_{OUT}$ = 1.20V, $I_Q$ = 2.5mA, $I_{SD}$ = 25µA, TSSOP16/E Package
LT1962	300mA, Low Noise Micropower, LDO	$V_{IN}$ : 1.8V to 20V, $V_{OUT}$ = 1.22V, $V_{DO}$ = 0.27V, $I_Q$ = 30µA, $I_{SD}$ = <1µA, Low Noise < 20µV <sub>RMS</sub> , MS8 Package
LT3011	50mA, High Voltage, Micropower LDO with PWRGD	$V_{IN}$ : 3V to 80V, $V_{OUT}$ : 1.275V to 60V, $V_{DO}$ = 0.3V, $I_Q$ = 46µA, $I_{SD}$ < 1µA, Low Noise: <100µV <sub>RMS</sub> PowerGood, Stable with 1µF Output Capacitor, 3mm × 3mm DFN-10 and Exposed MS12E Packages
LT3012	250mA, 4V to 80V, Low Dropout Micropower Linear Regulator	$V_{IN}$ : 4V to 80V, $V_{OUT}$ : 1.24V to 60V, $V_{DO}$ = 0.4V, $I_Q$ = 40µA, $I_{SD}$ < 1µA, TSSOP-16E and 4mm × 3mm DFN-12 Packages
LT3013	250mA, 4V to 80V, Low Dropout Micropower Linear Regulator with PWRGD	$V_{IN}$ : 4V to 80V, $V_{OUT}$ : 1.24V to 60V, $V_{DO}$ = 0.4V, $I_Q$ = 65µA, $I_{SD}$ < 1µA, PowerGood; TSSOP-16E and 4mm × 3mm DFN-12 Packages
LT3014	20mA, 3V to 80V, Low Dropout Micropower Linear Regulator	$V_{IN}$ : 3V to 80V (100V for 2ms, "HV" Version), $V_{OUT}$ : 1.22V to 60V, $V_{DO}$ = 0.35V, $I_Q$ = 7µA, $I_{SD}$ < 1µA, ThinSOT and 3mm × 3mm DFN-8 Packages
LT3050	100mA, Low Noise Linear Regulator with Precision Current and Diagnostic Functions	Input Voltage Range: 2V to 45V, Quiescent Current: 50µA, Dropout Voltage: 300mV; Low Noise: 30µV <sub>RMS</sub> (10Hz to 100kHz), Adjustable Output: $V_{REF}$ = 600mV; Programmable Precision Current Limit: ±5%, Programmable Minimum $I_{OUT}$ Monitor, Diagnostic $I_{OUT}$ Telemetry: 1/100th of $I_{OUT}$ , Fault Indicator: Current Limit, Minimum $I_{OUT}$ or Thermal Limit; Shutdown Current: < 1µA, Reverse Battery Protection, Current Limit Protection, Thermal Limit Protection, 12-Lead 3mm × 2mm DFN and MSOP Packages
LT3060	45V $V_{IN}$ , Micropower, Low Noise, 100mA Low Dropout Linear Regulator	Input Voltage Range: 1.7V to 45V, Quiescent Current: 40µA, Dropout Voltage: 300mV; Low Noise: 30µV <sub>RMS</sub> (10Hz to 100kHz), Adjustable Output: $V_{REF}$ = 600mV; Output Tolerance: ±2% Over Load, Line and Temperature, Single Capacitor Soft-Starts Reference and Lowers Output Noise, Shutdown Current: < 1µA, Reverse Battery Protection, Current Limit Foldback Protection, Thermal Limit Protection, 8-Lead 2mm × 2mm DFN and 8-Lead ThinSOT Packages

## X-ON Electronics

Largest Supplier of Electrical and Electronic Components

*Click to view similar products for [Power Management IC Development Tools](#) category:*

*Click to view products by [Analog Devices](#) manufacturer:*

Other Similar products are found below :

[EVAL-ADM1168LQEBZ](#) [EVB-EP5348UI](#) [MIC23451-AAAYFL EV](#) [MIC5281YMME EV](#) [DA9063-EVAL](#) [ADP122-3.3-EVALZ](#) [ADP130-0.8-EVALZ](#) [ADP130-1.2-EVALZ](#) [ADP130-1.5-EVALZ](#) [ADP130-1.8-EVALZ](#) [ADP1714-3.3-EVALZ](#) [ADP1716-2.5-EVALZ](#) [ADP1740-1.5-EVALZ](#) [ADP1752-1.5-EVALZ](#) [ADP1828LC-EVALZ](#) [ADP1870-0.3-EVALZ](#) [ADP1871-0.6-EVALZ](#) [ADP1873-0.6-EVALZ](#) [ADP1874-0.3-EVALZ](#) [ADP1882-1.0-EVALZ](#) [ADP199CB-EVALZ](#) [ADP2102-1.25-EVALZ](#) [ADP2102-1.875EVALZ](#) [ADP2102-1.8-EVALZ](#) [ADP2102-2-EVALZ](#) [ADP2102-3-EVALZ](#) [ADP2102-4-EVALZ](#) [ADP2106-1.8-EVALZ](#) [ADP2147CB-110EVALZ](#) [AS3606-DB](#) [BQ24010EVM](#) [BQ24075TEVM](#) [BQ24155EVM](#) [BQ24157EVM-697](#) [BQ24160EVM-742](#) [BQ24296MEVM-655](#) [BQ25010EVM](#) [BQ3055EVM](#) [NCV891330PD50GEVB](#) [ISLUSBI2CKIT1Z](#) [LM2744EVAL](#) [LM2854EVAL](#) [LM3658SD-AEV/NOPB](#) [LM3658SDEV/NOPB](#) [LM3691TL-1.8EV/NOPB](#) [LM4510SDEV/NOPB](#) [LM5033SD-EVAL](#) [LP38512TS-1.8EV](#) [EVAL-ADM1186-1MBZ](#) [EVAL-ADM1186-2MBZ](#)